



Laguna County Sanitation District Wastewater Reclamation Plan Facilities and Financial Master Plan

Prepared for

Laguna County Sanitation District

Prepared by



July 2010

Executive Summary

A Facilities and Financial Master Plan for the Laguna County Sanitation District (the District or LCSD) was prepared by CH2M HILL. The purpose of the master plan is to provide a clear direction for design and implementation of the next expansion and upgrades to the LCSD Wastewater Reclamation Plant (WWRP).

The objectives of the master plan are as follows.

- Provide an assessment of the District's service area growth rates
- Define future wastewater flows and loads
- Provide an assessment of the condition and capacity of the existing assets
- Evaluate treatment options and identify the best option for plant upgrades
- Develop an implementation plan for plant upgrades
- Develop a user charge/development impact fee model

CH2M HILL has executed numerous tasks to meet the master plan objectives and to provide a clear roadmap for implementation of future plant upgrades. In addition, the master plan addresses the financial impact of the capital and operations and maintenance (O&M) costs on the sewer users. The executed tasks were summarized and submitted to LCSD as five separate technical memorandums (TMs). This report combines all six TMs.

TM 1 (Background Evaluation of Laguna County Sanitation District's Wastewater Reclamation Plant) evaluated existing planning documents as well as raw wastewater flow and quality to project future wastewater flows and loads.

The raw wastewater quality presented in Table ES-1 reflects the current water quality, based on historical water quality data from the WWRP. It was assumed that the raw wastewater quality will not change in future. Therefore, the concentrations presented in Table ES-1 reflect future raw wastewater quality.

TABLE ES-1
WWRP Current and Future Raw Sewage Quality

Constituent	Concentration (mg/L)
Five-day biochemical oxygen demand (BOD ₅)	232
Total suspended solids (TSS)	210
Ammonia (N _x)	29
Total Kjeldahl nitrogen (TKN)	42
Average low total dissolved solids (TDS)	767
Average high TDS	1,758

mg/L = milligrams per liter

Considering the previous planning studies and future flows from additional sources, the influent (raw wastewater) flowrate for 2030 is projected to be 5.0 million gallons per day (mgd). This projection includes approximately 0.2 mgd wastewater flows from recently planned establishments (a new jail and a research park) and a future high total dissolved solids (TDS) flow of 0.06 mgd from City of Santa Maria. The projected flowrates are summarized in Table ES-2.

TABLE ES-2
Future (2030) Plant Flow Projections

Condition	Flow (mgd)
Average design flow	5.0
Peak dry weather flow	9.6
Peak wet weather flow	12.0

mgd = million gallons per day

For the future plant expansion, sizing and costing of the hydraulic components of plant facilities such as bar screens, grit removal, influent piping, and conveyance structures are based on peak wet weather flow of 12.0 mgd. Average daily flow and loads were used for sizing and costing of process tanks and equipment and for estimating air requirements, chemical and power usage, and biosolids generation.

A visual inspection was conducted to evaluate the condition of the existing WWRP facilities and equipment. The findings are summarized in TM 2 (LCSD WWRP Condition Assessment). The majority of electrical equipment is aged and beyond its useful service life, therefore requiring replacement in near future. Additionally, some of the mechanical equipment such as the primary clarifier drives and mechanisms are nearing the end of their useful service life. The concrete structures were generally in good condition, with the exception of the trickling filter, which has several deep vertical cracks and water leaks through the cracks. The trickling filter concrete structure needs replacement or needs to be abandoned in the near future. The WWRP process and mechanical deficiencies are summarized in a tabular format to show the facilities and equipment that require priority attention during plant upgrade (Table ES-3).

Liquid and solids treatment alternatives were screened and short-listed using a multi-criterion analysis in TM 3 (Treatment Alternatives Screening and Short-listing of Treatment Alternatives). The technologies were short-listed using weighting factors that were applied to a predetermined set of evaluation criteria to develop benefit scores for each alternative.

TABLE ES-3
 LCSD WWRP Facilities Planning Priority Review of Existing Treatment Units

Criteria	Headworks	Primary Clarifiers	Trickling Filter	Secondary Clarifier	Zeeweed Ultrafiltration System	High TDS MBR System	High TDS RO System	UV Disinfection	Anaerobic Digestion	Sludge Drying
Aging-condition	0	0	0	1	1	1	2	2	1	2
Repair and maintenance requirement	2	1	2	2	0	2	2	2	2	2
Capacity	1	2	1	1	1	2	2	2	2	2
Performance	1	1	1	1	1	2	2	2	1	2
Reliability	1	2	0	0	2	2	2	2	2	2
Regulatory concerns	2	2	2	1	2	2	2	2	2	0

- 0- Not acceptable, does not meet one or more parameters presented in the table, requires immediate attention-first priority
 1- Still meets all the criteria presented in the table currently or in near future (till 2014), deserves secondary priority
 2- Meets all the expectations and does not require attention in near future, deserves tertiary priority

MBR = membrane bioreactor
 RO = reverse osmosis
 TDS = total dissolved solids
 UV = ultraviolet

The short-listed technologies included:

- Secondary treatment alternatives
 - Conventional activated sludge (CAS)
 - Membrane bioreactor (MBR)
- Tertiary filtration alternatives
 - Membrane filtration
 - Cloth media filtration
- Sludge stabilization alternatives
 - Single-phase mesophilic anaerobic digestion
 - Two-phase anaerobic/aerobic digestion
 - Cannibal process

TM 4 (Identifying Most Suitable Treatment Options for Laguna County Sanitation District Wastewater Reclamation Plant), includes and evaluation of 16 treatment alternatives that combine secondary, tertiary and sludge stabilization options. Each alternative was evaluated in terms of 20-year life cycle costs in an effort to identify the treatment alternative(s) that exhibited highest benefit-to-cost ratio(s). The analysis identified one CAS alternative (Alternative 1) and one MBR alternative (Alternative 9) as the best alternatives, with virtually identical benefit-to-cost ratios. Based on further evaluation of these two alternatives, and feedback from the District's Operations staff, the MBR technology (Alternative 9) was selected.

A comprehensive implementation plan was developed in TM 5 (Laguna County Sanitation District Wastewater Reclamation Plant Facilities Planning Implementation Plan).

The objectives of TM 5 included the following:

- Establish project phasing
- Establish flow and solids mass balance, develop process flow diagram, and facility layout for the planning phases
- Identify project elements that will have impact before and during construction activities
- Develop cost estimate for the implementation plan elements and the costs for construction based on manufacturer quotes, recent project bids, and market conditions
- Develop an implementation schedule

A two-phase approach, as presented in Figure ES-1, is considered appropriate, in view of the size of the facility.

FIGURE ES-1
Proposed Timeframes for Phase I and Phase II Plant Upgrades

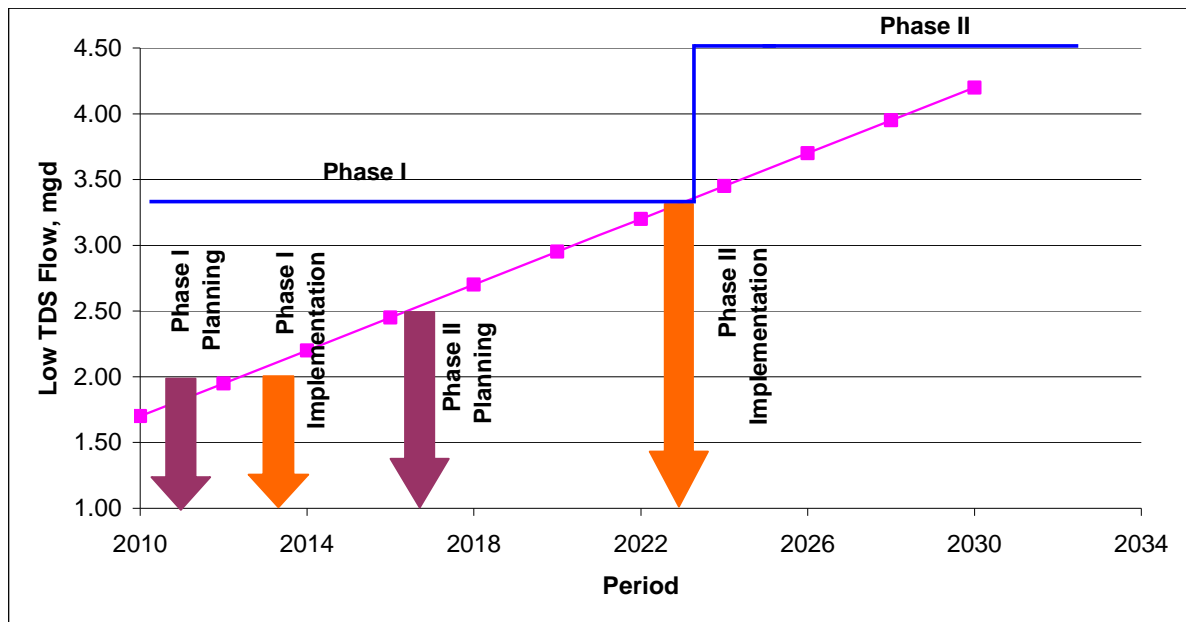

mgd = million gallons per day
TDS = total dissolved solids

For Phase I, the priority was given for upgrading:

- Unit treatment processes that are at or approaching their useful life
- Unit treatment processes that can handle current flows and loads but have difficulty in safely handling flowrates that will occur in the near future
- Key unit treatment processes without redundancy

Because of the need to replace aged infrastructure and concerns related to the available capacity of the existing ultrafiltration facility, the initial project phase (Phase I) activities should start as early as possible. Ideally, the initial phase, low TDS liquid treatment capacity of approximately 3.3 mgd (blue line in Figure ES-1), should be completed before 2014. The capacity of 3.3 mgd is the upper limit of the low TDS flow that can be treated without expanding the existing UV system and was estimated using the liquid treatment mass balance presented in TM 5. Ultimately, the plant low TDS liquid capacity should be expanded to 4.5 mgd (Phase II) by 2023.

The major upgrades in Phase I include addition of new headworks facility, new primary clarifiers, a new MBR system, a sludge thickening system, and lining of the existing sludge drying bed area. Phase II upgrades primarily include expansion of the Phase I facilities. The projected capital costs including project contingencies and contractor markups are \$45.8 million and \$30.7 million for Phases I and II, respectively.

A rate modeling developed by inputting projected Phase I and II capital and operating costs was presented to LCSD as part of TM 5. Based on the cost allocation and the value of the

existing infrastructure that would be used by new users, the connection fee would need to rise to \$7,960. This increase from the existing connection fee is attributable to significant escalation in construction costs that were substantially greater than the consumer price index over the past several years. The increase also reflects costs for a new recycled water distribution system. User charges would expect to see an increase of approximately \$10 per month once the bulk of the capital improvements begin construction.

TM 6 (Evaluation of Current Energy and Greenhouse Gas Regulations), provides an overview of greenhouse gas (GHG) regulations that may affect the District's WWRP, based on the primary GHG emissions sources at the existing plant and on the estimated sources based on the future plant recommendations described in this report. GHG emissions from the WWRP were estimated for carbon dioxide, methane, and nitrous oxide emissions, based on methodologies and emission factors in the California mandatory reporting of GHG emissions regulation in the *California Code of Regulations*. Emissions were estimated for combustion of natural gas, digester gas, and diesel for three scenarios: current (2009), Phase I, and Phase II.

TM6 describes the current status of California's Renewable Portfolio Standards, Renewable Electricity Standard, and other relevant energy policies. In addition, TM6 includes a summary of the various funding opportunities administered by the California Public Utilities Commission to assist LCSD in considering its options regarding renewable energy development.

Background Evaluation of Laguna County Sanitation District’s Wastewater Reclamation Plant

PREPARED FOR: Laguna County Sanitation District

PREPARED BY: CH2M HILL

DATE: June 22, 2009

Contents

1.0	Introduction.....	1-1
1.1	Objective	1-1
1.2	Project Location and Background	1-1
1.3	Previous Planning Studies	1-4
2.0	Current Discharge Permits	2-1
2.1	Plant Effluent Quality Requirements.....	2-1
2.2	Biosolids Quality Requirements.....	2-3
2.3	Recycled Water Quality Requirements	2-3
	2.3.1 Title 22.....	2-3
	2.3.2 Title 22, Article 3.....	2-4
	2.3.3 Title 17.....	2-5
	2.3.4 Water Code.....	2-5
2.4	Basin Plan	2-5
3.0	Wastewater Characterization.....	3-1
3.1	Historical Flow Data	3-1
	3.1.1 Rainfall Records.....	3-2
	3.1.2 Plant Diurnal Flows and Peaking Factors.....	3-3
3.2	Historical Raw Wastewater Characterization	3-11
3.3	Historical Effluent Quality	3-15
4.0	Flows Projections.....	4-1
4.1	Population Projections	4-1
4.2	Return to Sewer Rates.....	4-2
4.3	Wastewater Flow Projections.....	4-3
5.0	Future Discharge Regulations.....	5-1
5.1	Title 22 Requirements	5-1
5.2	Disinfection By-Products and Emerging Contaminants.....	5-1
5.3	New Recycled Water Policy.....	5-1
5.4	Conditional Letter of Map Revision	5-2
6.0	Summary and Conclusions.....	6-1
7.0	References	7-1

Tables

- 2-1 WDRS and Title 22 Recycled Water Requirements for the LCSD WWRP per Order 01-042 (May 2001)
- 2-2 WDRs for the LCSD WWRP Secondary Treatment Standards per Order 01-042 (May 2001)
- 3-1 LCSD Plant Influent through the North and South Trunk Lines (from Hach Data Delivery Service Web Site)
- 3-2 Plant Dry and Wet Weather Flows and Peaking Factors
- 3-3 Average Flows during August 2008 to March 2009
- 3-4 Recommended Peaking Factors for Gravity Sewer Design
- 3-5 Plant Influent Quality
- 3-6 Plant Influent Flow and BOD and TSS Loads
- 3-7 Recent WRP Influent Water Quality Data
- 4-1 Orcutt Service Area Historical and Projected Population and 2005 UWMP 30-Year Population and Wastewater Flow Projections
- 4-2 Average Day Sewer Duty Factors
- 4-3 Existing Flows and Future Wastewater Flow Projections
- 4-4 LCSD Plant Capacity and Demand (Orcutt Community Plan, 1997)
- 4-5 Future Plant Flow Projections in 2030
- 6-1 Plant Dry and Wet Weather Flows and Peaking Factors
- 6-2 WWRP Current Raw Sewage Quality
- 6-3 Future (2030) Plant Flow Projections

Figures

- 1-1 Laguna County Wastewater Treatment Plant Location Map (Feasibility Study of Treated Wastewater Discharge Options, 2008)
- 1-2 Laguna County Wastewater Treatment Plant Service Area (GSWC, 2006)
- 3-1 Historical Daily Plant Flows Measured Upstream of Pond A from 2006 to 2008
- 3-2 Rainfall Data Recorded in Santa Maria - Orcutt Flood Control Station and Santa Maria City Station
- 3-3 Maximum and Average Daily Flows in the North Trunk from August 7, 2008 to June 11, 2009
- 3-4 Maximum and Average Daily Flows in the South Trunk from August 7, 2008, to June 11, 2009
- 3-5 Maximum Wet Weather Flow in the North Trunk (Recorded on November 27, 2008)
- 3-6 Maximum Wet Weather Flow in the South Trunk (Recorded on November 27, 2008)
- 3-7 Maximum Dry Weather Flow in the North Trunk (Recorded on September 1, 2008)
- 3-8 Maximum Dry Weather Flow in the South Trunk (Recorded on September 1, 2008)
- 3-9 System Maximum Wet Weather Flow and Wet Weather Peaking Factor (Recorded on November 27, 2008)
- 3-10 System Maximum Dry Weather Flow and Dry Weather Peaking Factor (Recorded on November 27, 2008)
- 3-11 TDS Concentration in the High-TDS and Low-TDS Flow Streams at the WWRP
- 3-12 Historical Plant Influent Monthly Average BOD and TSS Concentrations
- 3-13 Plant Effluent Average TDS, Sodium, Chloride, and Sulfate Concentrations
- 4-1 Summary of the Wastewater Flow Projections

Appendices

- A Location of the New Flowmeters in North and South Trunk Lines
- B System Total Flow Data during August 2008 and March 2009
- C FEMA Flood Map No. 06083C0170

1.0 Introduction

1.1 Objective

Laguna County Sanitation District (District or LCSD) is preparing a Facilities and Financial Master Plan for the LCSD wastewater reclamation plant (WWRP). The purpose of the master plan is to provide a clear direction for design and implementation of the next expansion and upgrades to the reclamation plant.

The objectives of the master plan are as follows.

- Provide an assessment of the District's service area growth rates
- Define future wastewater flows and loads
- Provide an assessment of the condition and capacity of the existing assets
- Develop a user charge/development impact fee model
- Evaluate treatment options and identify the best option for plant upgrades
- Develop an implementation plan for plant upgrades

This technical memorandum (TM) summarizes the background information that will be the basis of the master plan. The major elements of this TM include the following.

- Summary of existing planning documents
- Existing and future regulatory requirements
- Evaluation of existing raw influent flow and quality, as well as effluent quality
- Projection of future wastewater flows and loads

The information summarized in this TM will serve as a basis for TM 2 (Alternative Screening) and TM 3 (Alternative Evaluation and Selection).

1.2 Project Location and Background

LCSD owns and operates a WWRP located at the western terminus of Dutard Road off Black Road on a 20-acre parcel (No.113-240-005) in Santa Maria, California (Figure 1-1).

FIGURE 1-1
 Laguna County Wastewater Treatment Plant Location Map (Feasibility Study of Treated Wastewater Discharge Options, 2008)

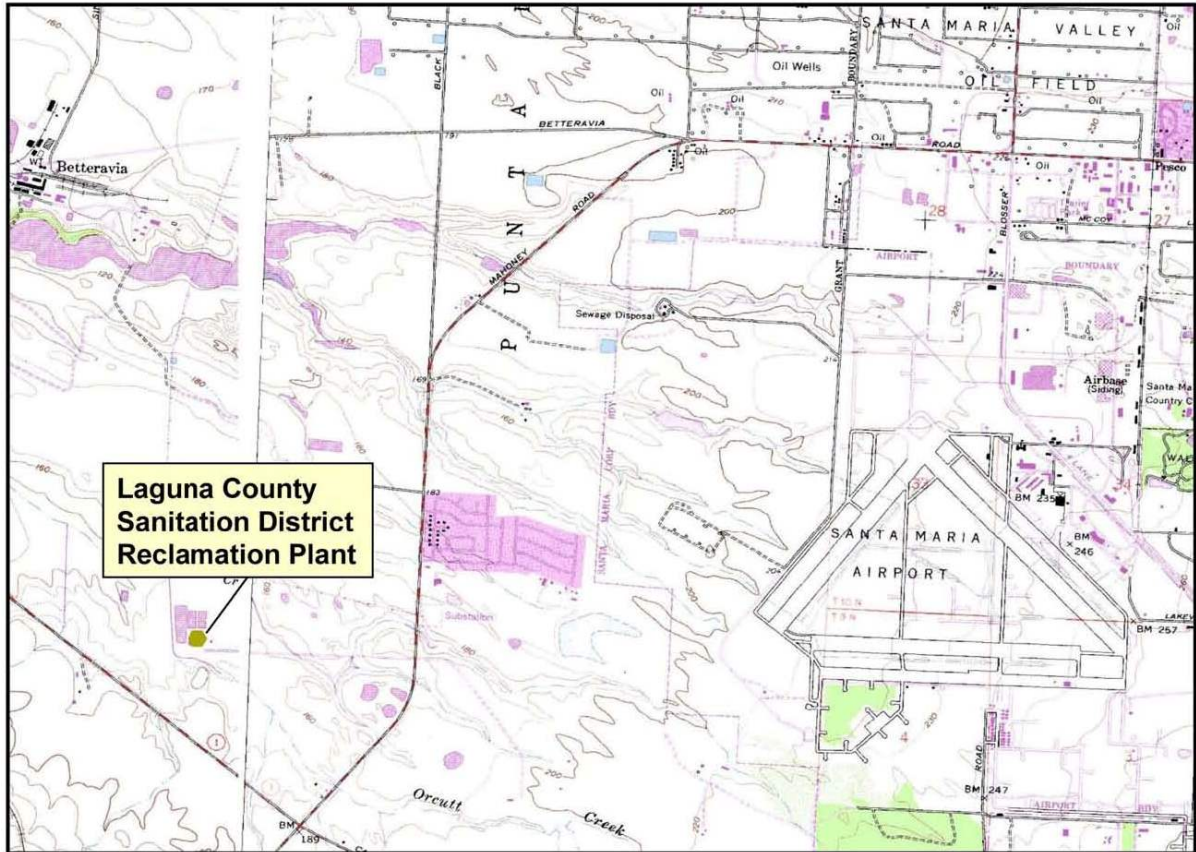

Base Map: USGS 7.5 Minute Quadratic Maps
 Guadalupe (1982) and Santa Maria (1982)

FIGURE 1
 Location Map
 LCSD

The treatment facility serves the unincorporated areas of Santa Maria, portions of the city of Santa Maria, and the unincorporated community of Orcutt. Figure 1-2 illustrates the WWRP existing service area boundary and the Orcutt community planning boundary.

FIGURE 1-2
Laguna County Wastewater Treatment Plant Service Area (GSWC, 2006)

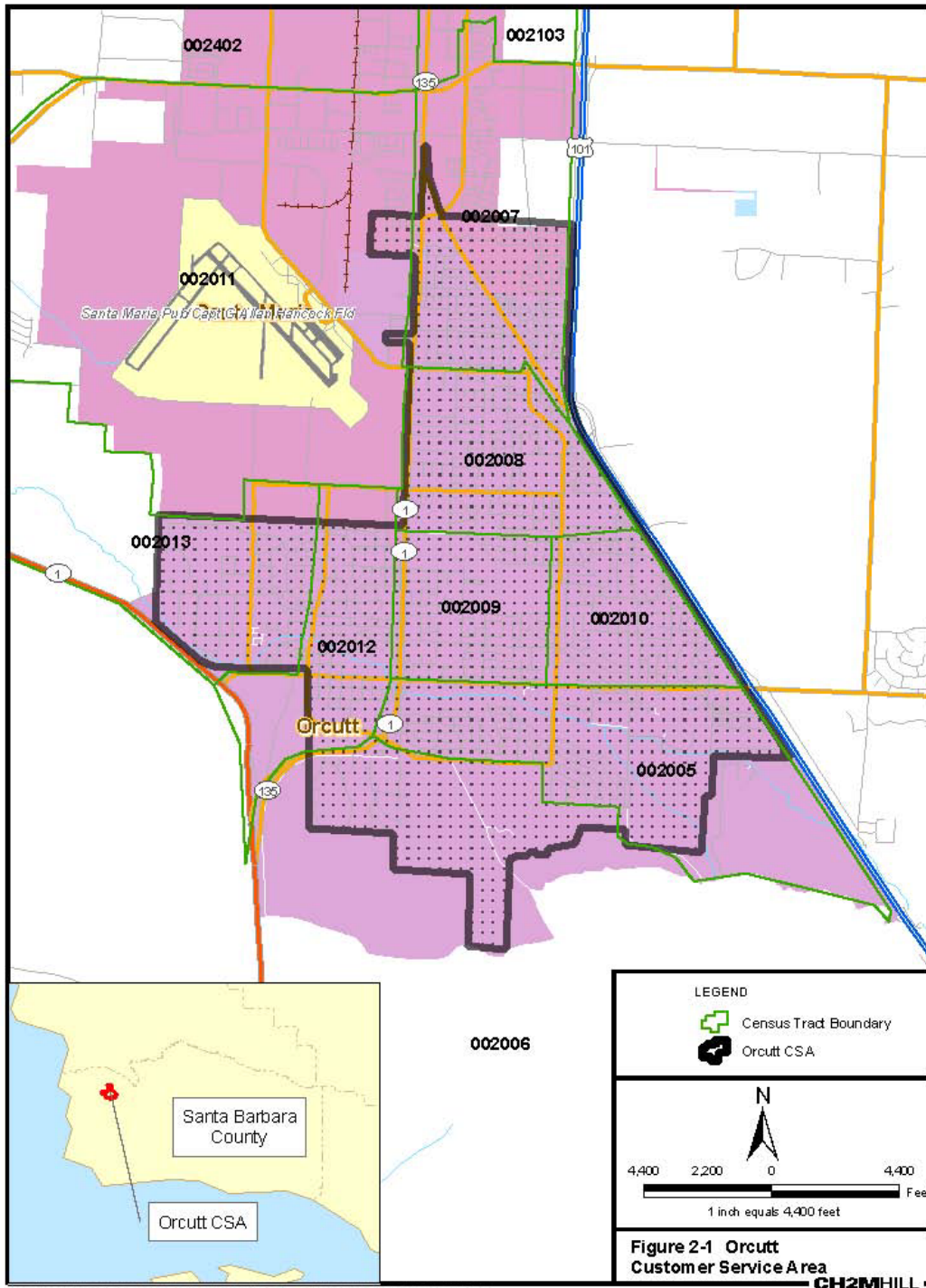

LCSD owns and maintains 129 miles of collection system piping and one lift station and force main. Wastewater is generated primarily from domestic sources with minor contributions from commercial establishments. Previously, the facility treated wastewater to undisinfected secondary treatment levels, which was stored in holding ponds onsite before being pumped

to site and offsite locations for spray irrigation over 410 acres of surrounding pasture lands (historically sugar beet fields). The WWRP was built in 1959 with an initial capacity of 1.6 million gallons per day (mgd). The WWRP capacity was increased to 2.4 mgd in 1974 and increased again in 1986 to 3.2 mgd. In 2004, LCSD completed upgrades to the reclamation plant to address water quality issues, including total dissolved solids (TDS), sodium, and chloride. The 2004 upgrades added a second plant to process the salt loading condition and increased capacity to 3.7 mgd of Title 22 disinfected tertiary recycled water for unrestricted reuse, which began in June 2005. The 2004 project included 3.7 mgd ultraviolet (UV) disinfection facility, tertiary filtration to the old plant, and a new 0.5-mgd treatment train to treat the high-TDS wastewater produced by the nightly regeneration of water softeners. LCSD made an attempt to enact a Brine Ordinance to prohibit the use of home regenerating saltwater softeners by 1996; however, the Ordinance was successfully challenged in court (Community of Orcutt, 1997).

The plant currently treats low- and high-TDS streams separately once preliminary treatment (screening, grit removal) is provided for low- and high-TDS streams. The low-TDS treatment train includes trickling-filter-based-biological treatment, secondary clarification, and membrane filtration. The high-TDS treatment train includes membrane bioreactor (MBR) and reverse osmosis (RO). The membrane filtration effluent and RO permeate from low- and high-TDS treatment systems are blended prior to the UV disinfection. Reverse osmosis concentrate is disposed into a Class 1 nonhazardous injection well. The plant is regulated by the Regional Water Quality Control Board (RWQCB) – Central Coast Region under Waste Discharge Requirements (WDRs) and Master Reclamation Permit Order 01-042 adopted May 22, 2001. The injection well is regulated by U.S. Environmental Agency (USEPA) permit# CA/000001.

The primary and secondary sludge are digested in the anaerobic digesters. The digested sludge is dewatered in sludge drying beds. The cake from sludge drying beds is periodically collected and sent it to a composting facility.

Recycled water is used for agricultural uses at one offsite user location and on permanent pastureland used for grazing nondairy cattle. Recycled water not used at the time of production is stored in a reservoir or ponds owned and operated by LCSD for later irrigation on the District properties.

1.3 Previous Planning Studies

The documents and previous planning study reports used to develop this TM include:

1. *Draft Sewer Collection System Master Plan* (January 2009) prepared by Penfield and Smith Engineers for Laguna County Sanitation District.
2. *Feasibility Study of Treated Wastewater Discharge Options* (May 2008) prepared by CH2M HILL for County of Santa Barbara Public Works Department – Laguna County Sanitation District.
3. *Golden State Water Master Plan for Orcutt System* (2007) prepared by CH2M HILL for Golden State Water Company (GSWC) as part of planning reports for updating the existing Orcutt System Master Plan.

4. *2005 Urban Water Management Plan; Orcutt* (Final Report, June 2006) prepared by CH2M HILL for Golden State Water Company Region I Headquarters.
5. *Wastewater/Reclamation Treatment plant (WRTP) Conceptual Master Plan for Build Out to 7 mgd* (Final Draft, February, 2001) prepared by CH2M HILL for County of Santa Barbara Public Works Department – Laguna County Sanitation District
6. *Orcutt Community Plan, Section G. Sewer, Board of Supervisors Final Plan, (July 1997).*

The *Draft Sewer Collection System Master Plan* was used to obtain information on updated customer connections, results of the recent flow study, return to sewer generation rates (day sewer duty factors), and the projected future wastewater flows (Penfield and Smith, 2009). In addition, the document provided information on the recommended dry weather peaking factor and hourly peaking factors established from the two newly installed flowmeters in the North and South Trunks conveying the wastewater to the WWRP.

The *Feasibility Study of Treated Wastewater Discharge Options* was used to obtain information on the WWRP existing permits and the evaluation of wastewater discharge options (CH2M HILL, 2008). The *2007 Water Master Plan for Orcutt System* was used to compare the existing and future average water demand with the projected future wastewater flows (CH2M HILL, 2007). Using a conversion factor, the average water demand for the Orcutt system was used to estimate the future wastewater generation. The *2005 Urban Water Management Plan* provided projected population for the service area and the projected future average wastewater flows (CH2M HILL, 2006).

Document 5 provided information on the WWRP facilities and the *Orcutt Community Plan (OCP) 1997* provided information on future developments in the community and projected flows for Orcutt and WWRP.

2.0 Current Discharge Permits

The main regulatory agencies governing recycled water use in California are the California Department of Public Health (CDPH) and the California State Water Resources Control Board (SWRCB). The SWRCB is divided into nine RWQCBs that administer the regulations for septic reuse projects in conformance with the regulations adopted by the CDPH. The LCSD is under jurisdiction of the Santa Barbara District of CDPH, and Central Coast Region RWQCB. This section provides an overview of the current permits and regulations applicable to LCSD WWRP operation. Anticipated future regulations are discussed in Section 5 of this TM.

2.1 Plant Effluent Quality Requirements

The WWRP effluent is recycled and reused for irrigation of local pasture and agricultural land. Therefore, the WWRP operates under the WDRs and Master Recycling Permit Order No. 01-042 (Order No. 01-042). Order No. 01-42 provides for discharge and reuse of tertiary treated recycle wastewater.

The discharge should comply with Division 7 of the California Water Code and any more stringent effluent limitations necessary to implement water quality control plans, to protect beneficial uses, and to prevent nuisance. Currently, the plant effluent is treated to disinfected tertiary levels following the Title 22 requirements. The plant discharge criteria per Order 01-042 are shown in Table 2-1.

TABLE 2-1
WDRS and Title 22 Recycled Water Requirements for the LCSD WWRP per Order 01-042 (May 2001)

Constituent	Value	
WDRs		
Dissolved Oxygen (DO)	≥ 2 mg/L	
Dissolved Sulfide	≤ 0.1 mg/L	
pH	6.5-8.4	
Maximum Daily Flow	3.7 mgd (Mean)	
Five Day Biochemical Oxygen Demand (BOD ₅)	10 mg/L (Mean)	25 mg/L (Maximum)
Suspended Solids	10 mg/L (Mean)	25 mg/L (Maximum)
Settleable Solids	--	0.1 mg/L (Maximum)
Oil and Grease	1 mg/L (Mean)	5 mg/L (Maximum)
Total Dissolved Solids (TDS)	900 mg/L (12-month running means)	
Sodium	180 mg/L (12-month running means)	
Chloride	150 mg/L (12-month running means)	
Sulfate	300 mg/L (12-month running means)	
Boron	0.5 mg/L (12-month running means)	

TABLE 2-1
WDRS and Title 22 Recycled Water Requirements for the LCSD WWRP per Order 01-042 (May 2001)

Constituent	Value
Title 22 Requirements	
Turbidity	Less than 0.5 NTU at all times Not to exceed 0.2 NTU more than 5 percent of the time during a 24-hour period
Total Coliform Bacteria	2.2 MPN per 100 ml per sample, median reading not to exceed over any 7-day continuous period 23 MPN per 100 ml per sample, not to occur more than once within 30 days

Notes:
 mgd – million gallons per day
 mg/L – milligrams per liter
 MPN – most probable number
 NTU – nephelometric turbidity unit

Recycled water is distributed to user sites or stored in reservoirs for future irrigation or distribution. Because the plant does not discharge to a water body or watercourse, it operates following the WDRs as opposed to National Pollutant Discharge Elimination System (NPDES) permit. Options to pursue groundwater injection disposal or groundwater recharge were rejected due to the cost compared to irrigation discharge (CH2M HILL 2008). Disposal of brine concentrate from the RO process will continue to be achieved by deep well injection into a Class 1 nonhazardous injection well regulated by the USEPA.

Redundancy is provided with secondary treatment standards for discharge on District pastureland used for grazing nondairy cattle. The secondary standards are shown in Table 2-2.

TABLE 2-2
WDRs for the LCSD WWRP Secondary Treatment Standards per Order 01-042 (May 2001)

Constituent	Mean (mg/L)	Maximum (mg/L)
BOD ₅	40	100
Suspended Solids	40	100
Settleable Solids	0.1	0.4
Oil and Grease	20	30
TDS*	1,200 (1,000*)	
Sodium*	250 (200*)	
Chloride*	300 (125*)	
Sulfate*	300	
Boron*	0.5	

Notes:
 * Compliance shall be based on 12-month running means.

2.2 Biosolids Quality Requirements

Biosolids reuse and disposal practices are regulated by federal, state, and local agencies. The primary federal regulation for biosolids management is 40 CFR 503 (Part 503 Rule). In California, the Part 503 Rule is enforced through NPDES permits. Promulgated in 1993, the regulations under the Part 503 Rule apply to land application, surface disposal, and incineration of biosolids. The Part 503 Rule standards include pollutant limits, management practices, and operational criteria, as well as monitoring, record keeping, and reporting requirements for biosolids use and disposal. For land application, the rule establishes metal limits, pathogen reduction requirements, and vector attraction reduction requirements. The rule establishes two classes of pathogen reduction, Class A and Class B. The level of pathogen reduction and the treatment processes used can determine the classification (i.e., Class A, Class B, etc.).

At the WWRP, anaerobic digestion followed by air drying is utilized (LCSD, 2007) to meet the requirements of 503 regulations to produce Class "B" biosolids.

Per Order No 01-042, the District shall provide to the RWQCB an annual list of any new industrial and commercial contributors and other sewage facilities along with the waste characterization for each. In addition, biosolids shall be disposed of at a site approved by the Executive Officer. Biosolids generated at the plant are stored onsite in drying beds and periodically removed for transport offsite. The biosolids are currently transported to Engel & Gray Inc. composting facility in Santa Maria (CH2M HILL, October, 2003).

2.3 Recycled Water Quality Requirements

Recycled water quality must meet not only the criteria set by regulatory agencies, but also the individual requirements of the potential users. The production, discharge, distribution, and use of recycled water are regulated under California Code of Regulations (CCR) Title 22, CCR Title 17, California Water Code, Division 7 - Water Quality, Sections 13000 through 13999.16 (Water Code), and California RWQCB - Central Coast Region Basin Plan.

2.3.1 Title 22

CCR Title 22 - Security, Division 4 - Environmental Health, Chapter 3, Division 4 - Reclamation Criteria establishes the requirements for recycled water treatment, quality, and allowable use. The California Water Recycling Criteria in Sections 60301 through 60355, inclusive, of the CCR Title 22 prescribe the following parameters.

- Recycled water quality and wastewater treatment requirements for the various types of uses
- Reliability features required in the treatment facilities to ensure safe performance
- Use area requirements pertaining to the actual recycled water use location

Bacteriological water quality standards, as well as treatment processes and/or water quality required for an effluent to be used for a specific nonpotable application, are defined in Title 22. Division 4, Chapter 3 of Title 22 describes water recycling criteria to protect public health and ensure safety in water recycle and reuse practices.

2.3.2 Title 22, Article 3

Title 22 CCR, Division 4, Chapter 3 defines water-recycling criteria. Article 3, Section 60304 states, recycled water used for surface irrigation of the following shall be disinfected tertiary recycled water, unless it has been filtered in accordance with Section 60301.320(a).

Disinfected tertiary recycled water is defined as a filtered and subsequently disinfected wastewater that meets the following requirements. Section 60301.320(a) states that filtered wastewater must be oxidized and passed through:

- a) Natural undisturbed soils or a bed filter media pursuant to the following:
 1. At a rate that does not exceed 5 gallons per minute per square foot of surface area in mono, dual, or mixed gravity, upflow or pressure filtration systems, or does not exceed 2 gallons per minute per square foot of surface area in traveling bridge automatic back wash filters
 2. That the turbidity of the filtered wastewater does not exceed any of the following:
 - An average of 2 nephelometric turbidity unit (NTU) within a 24-hour period
 - 5 NTU more than 5 percent of the time within a 24-hour period
 - 10 NTU at any time

or
- b) Microfiltration, ultrafiltration, nanofiltration or reverse osmosis membrane following which the turbidity does not exceed any of the following:
 - 0.2 NTU more than 5 percent of the time within a 24- hour period
 - 0.5 NTU at any time

The filtered wastewater has been disinfected by either:

- a) A chlorine disinfection process following filtration that provides a chlorine residual/contact time value of not less the 450 milligram-minutes per liter at all times with a modal contact time of at least 90 minutes, based on peak dry weather design flow.
- b) A disinfection process that, when combined with the filtration process, has been demonstrated to inactivate and or remove 99.999 percent of plaque forming units of F-specific bacteriophage MS2, or polio virus in the wastewater. A virus that is at least as resistant to disinfection as polio virus may be used for purposes of demonstration (applicable to the current treatment process at LCSD).

In each disinfection option, the median concentration of total coliform bacteria measured in the disinfected effluent does not exceed:

- A most probable number (MPN) of 2.2 per 100 milliliters utilizing the bacteriological results of the last 7 days
- An MPN of 23 per 100 milliliters in more than one sample in any 30-day period
- An MPN of 240 total coliform bacteria per 100 milliliters at any time

2.3.3 Title 17

Title 17 focuses on the protection of drinking (potable) water supplies through control of cross-connections with potential contaminants, including nonpotable water supplies such as recycled water. Title 17 specifies the minimum backflow protection required on the potable water systems for situations in which there is potential for contamination to the potable water supply. The local county health departments are responsible for overseeing cross-connection programs implemented by potential recycled water users.

2.3.4 Water Code

The Water Code requires the owner of a WWRP to obtain approval from the SWRCB prior to making any change in the point of discharge, place of use, or purpose of use of treated water.

2.4 Basin Plan

The California RWQCB for the Central Coast Region adopted a Basin Plan on November 19, 1989. The Basin Plan is a water quality control plan for the surface and groundwater in the Central Coast Region. The Basin Plan identifies the water uses; describes the water quality that must be obtained to allow the uses; and describes the programs, projects, and actions necessary to achieve the water quality standards. In addition, the Basin Plan identifies state policies to protect water quality and state programs for surveillance and monitoring. Among the state policies identified in the Basin Plan is the Anti-degradation Policy, which is intended to "maintain high quality waters in California." The policy provides conditions under which a change in water quality is allowable. A change must:

- Be consistent with the maximum benefit to the people of the state
- Not unreasonably affect present and anticipated beneficial uses of water
- Not result in water quality less than that prescribed in water quality control plans or policies

The Basin Plan does not designate surface water quality objectives for Orcutt Creek. The median groundwater quality objectives for TDS, chloride, sulfate, boron, sodium, and nitrate (N) for the Orcutt Sub-Area and the Upper Guadalupe Sub-Area are listed in the WDRs Order No. 01-042.

3.0 Wastewater Characterization

The purpose of this section is to identify influent flows and current wastewater quality based on the plant historical data.

3.1 Historical Flow Data

Flows to the reclamation plant were historically recorded on a daily interval. The flowmeter is located between the secondary clarifier and Pond A. The flow at this location does not include the high-TDS flow. Figure 3-1 shows the plant low-TDS flow during January 2006 to December 2008.

FIGURE 3-1
Historical Daily Plant Flows Measured Upstream of Pond A from 2006 to 2008

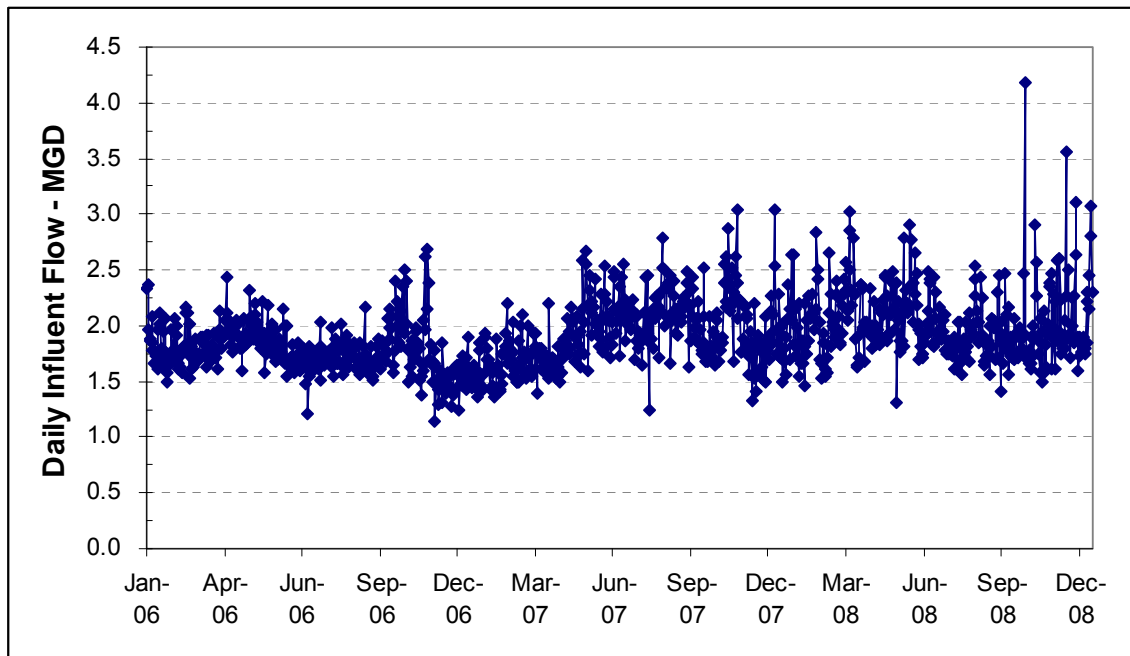

In August 2008, the District installed a permanent flowmeter on each of its trunk lines to monitor influent flows to the WWRP. The locations of the flowmeters are shown in Appendix A. For the purpose of this TM, the flow data for the two newly installed flowmeters, manhole (MH) 1959 on the North Trunk line and MH 1816 on the South Trunk line, were downloaded from Hach Data Delivery Services web site. The flow rates were recorded every 15 minutes starting on August 7, 2008. The total flows of the system through the North and South Trunk lines are shown in Appendix B. Because the flow measurements prior to August 2008 were recorded downstream of secondary clarifier, they did not reflect actual flows coming to WWRP. As such, daily and instantaneous flow variations in raw wastewater could not be evaluated; therefore, flow measurements recorded after August 2008 were used in this evaluation. Table 3-1 summarizes the flow data in each trunk line and

the total flows (sum of flows in the North and South Trunk lines) on a monthly basis from August 2008 to May 2009.

TABLE 3-1
LCSD Plant Influent through the North and South Trunk Lines (from Hach Data Delivery Service Web Site)

Month	North Trunk (mgd)			South Trunk (mgd)			Total (mgd)	
	Min Hourly	Avg Monthly	Max Hourly	Min Hourly	Avg Monthly	Max Hourly	Avg Monthly	Max Instantaneous Flow
Aug 2008	0.45	1.47	2.67	0.07	0.30	0.67	1.77	3.34
Sept 2008	0.41	1.49	2.73	0.07	0.29	0.72	1.79	3.45
Oct 2008	0.46	1.61	3.13	0.07	0.30	0.72	1.91	3.85
Nov 2008	0.50	1.75	3.49	0.09	0.33	0.90	2.08	4.40
Dec 2008	0.52	1.75	3.19	0.09	0.36	0.85	2.11	4.04
Jan 2009	0.51	1.69	3.06	0.08	0.37	0.83	2.06	3.89
Feb 2009	0.51	1.76	3.11	0.09	0.39	0.89	2.15	4.00
Mar 2009	0.49	1.73	3.08	0.08	0.36	0.87	2.09	3.95
Apr 2009	0.48	1.69	3.03	0.08	0.35	0.80	2.05	3.83
May 2009	0.48	1.71	3.13	0.07	0.35	0.79	2.05	3.92

Notes:

Min(imum) and Max(imum) hourly flow rates refer to min(imum) and max(imum) instantaneous flow rates.

Maximum hourly to average monthly flow ratios are much higher in the South Trunk line than in the North Trunk line, indicating that more flow fluctuations are occurring in the South Trunk. However, the South Trunk contributes a minor fraction of the total flow; therefore, flows in the North Trunk line will primarily determine the WWRP flow peaking ratios. The existing WWRP headworks capacity can handle these peak flows, and low- and high-TDS ponds dampen the diurnal flow fluctuations.

3.1.1 Rainfall Records

The monthly average rainfall records for the stations in the LCSD service area, Orcutt Station, Santa Maria - Orcutt Flood Control, and Santa Maria City are presented in Figure 3-2. The records indicated the most rain occurred in November, December, and February.

FIGURE 3-2
Rainfall Data Recorded in Santa Maria – Orcutt Flood Control Station and Santa Maria City Station

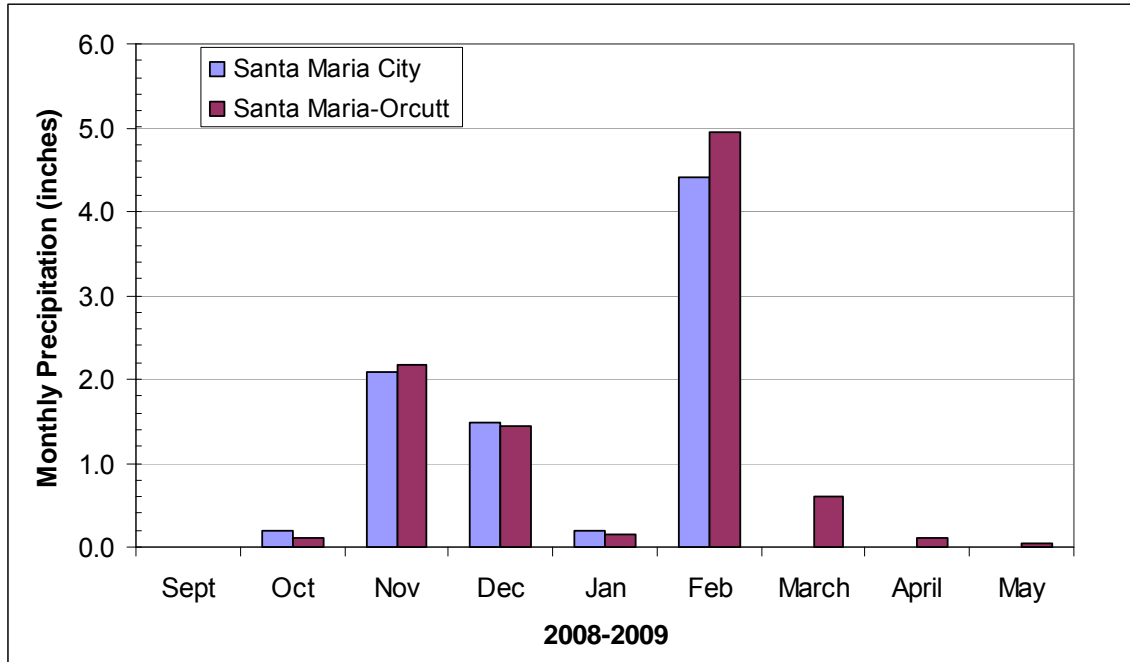

Source Santa Barbara County Web site: <https://www.countyofsb.org/pwd/water/raindaily.htm>

There were no rainfall data available prior to September 2008. The rainfall data for March through May 2009 were not available at the Santa Maria City Station. The highest rainfall occurred in February. The 30-year historical precipitation data (CH2M HILL, 2006) also identified February as the wettest month followed by January, March, December, November, and April in that order. The dry weather occurred from May through September.

3.1.2 Plant Diurnal Flows and Peaking Factors

Figures 3-3 and 3-4 show dry weather, wet weather periods, and maximum and average daily flows in the North and South Trunks during August 7, 2008, and June 11, 2009, on a daily basis.

FIGURE 3-3
Maximum and Average Daily Flows in the North Trunk from August 7, 2008, to June 11, 2009

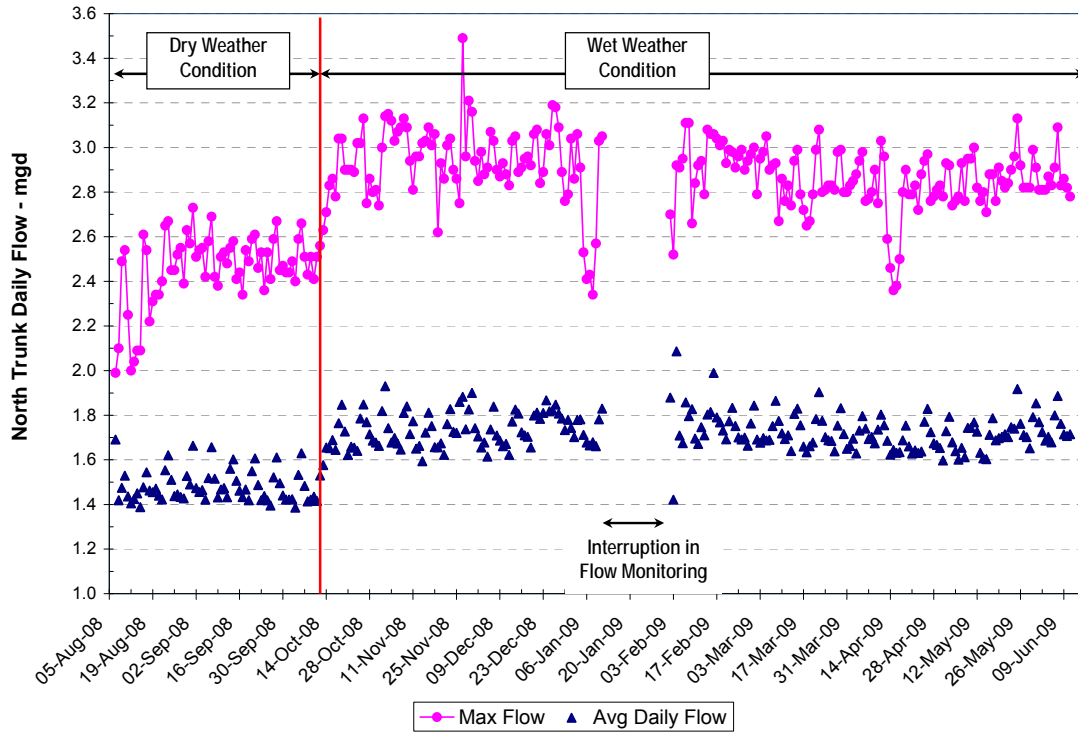
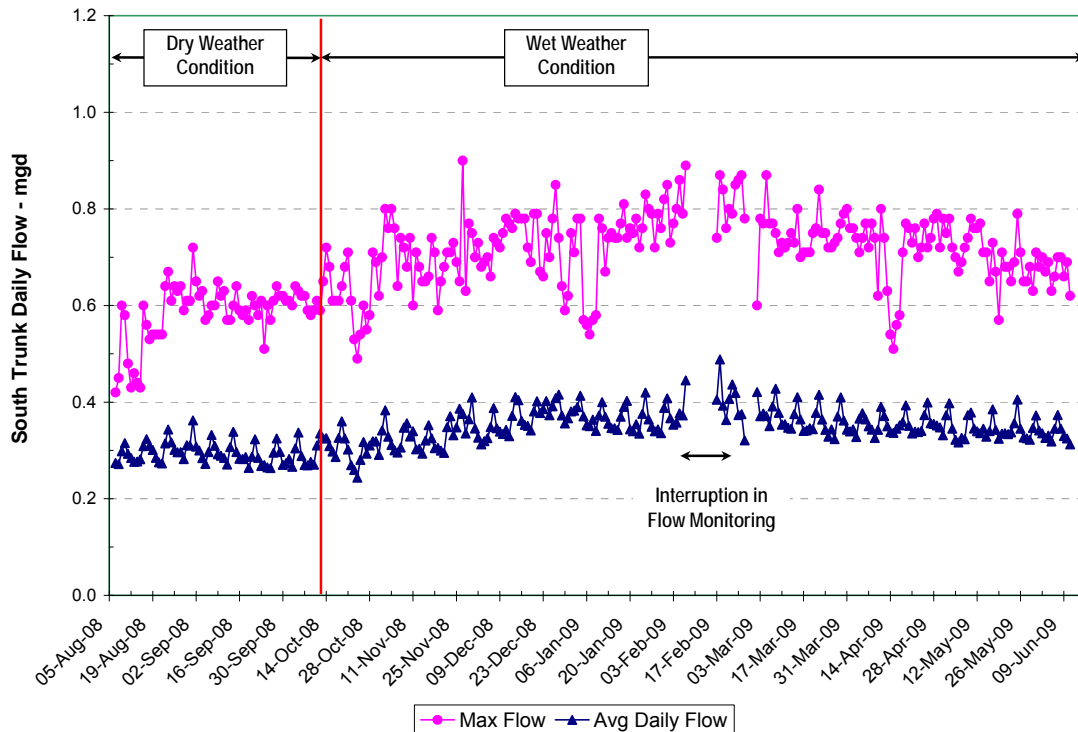

FIGURE 3-4
Maximum and Average Daily Flows in the South Trunk from August 7, 2008, to June 11, 2009



The flow monitoring in the North Trunk was interrupted from January 12 through February 3, 2009, during which time either no flow was recorded or the recordings were limited to only a few times per day. The flow monitoring in the South Trunk was interrupted from February 8 through February 16, 2009. In addition, the flow was not monitored on February 27 and February 28, 2009. According to the flow data illustrated in Figures 3-3 and 3-4, the dry weather period was from August 7 to October 13, 2008.

High flows through the North Trunk occurred in November and December. The highest flow of 3.49 mgd was observed on November 27, 2008. Figure 3-5 shows the diurnal flow on November 27.

FIGURE 3-5
Maximum Wet Weather Flow in the North Trunk (Recorded on November 27, 2008)

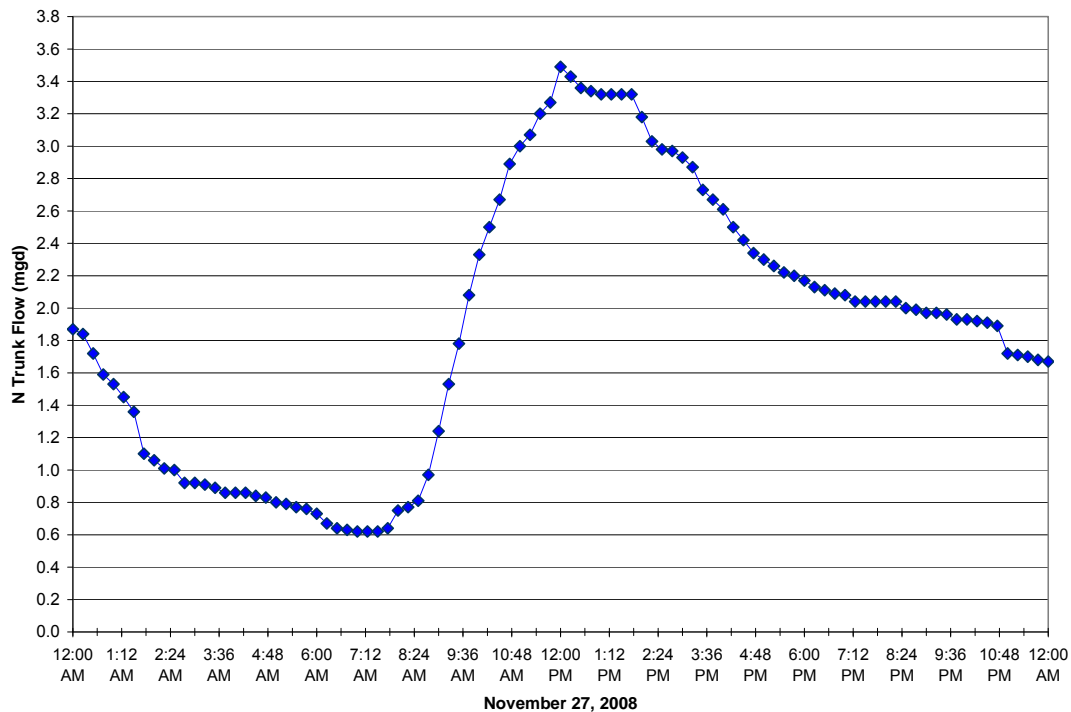

The flow rates through the South Trunk were significantly lower and ranged from 0.07 mgd to 0.90 mgd. Figure 3-6 shows the diurnal flow in the South Trunk on November 27, 2008, when the highest flow of 0.90 mgd was observed. Although the rainfall in February 2009 was the highest, it was not reflected in the February flow data for both lines.

FIGURE 3-6
Maximum Wet Weather Flow in the South Trunk (Recorded on November 27, 2008)

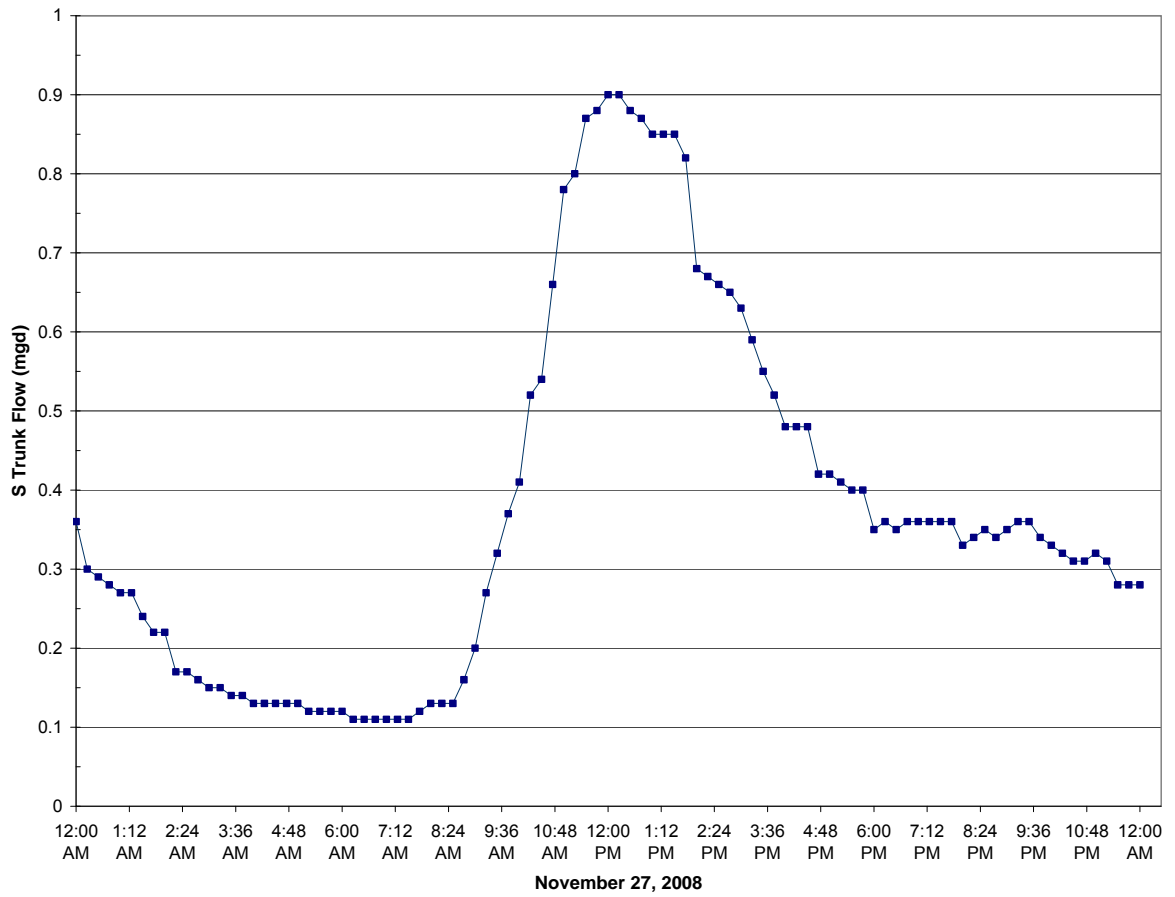

The maximum dry weather flow occurred on September 1. The diurnal flows in the North and South Trunks are shown in Figures 3-7 and 3-8, respectively.

FIGURE 3-7
Maximum Dry Weather Flow in the North Trunk (Recorded on September 1, 2008)

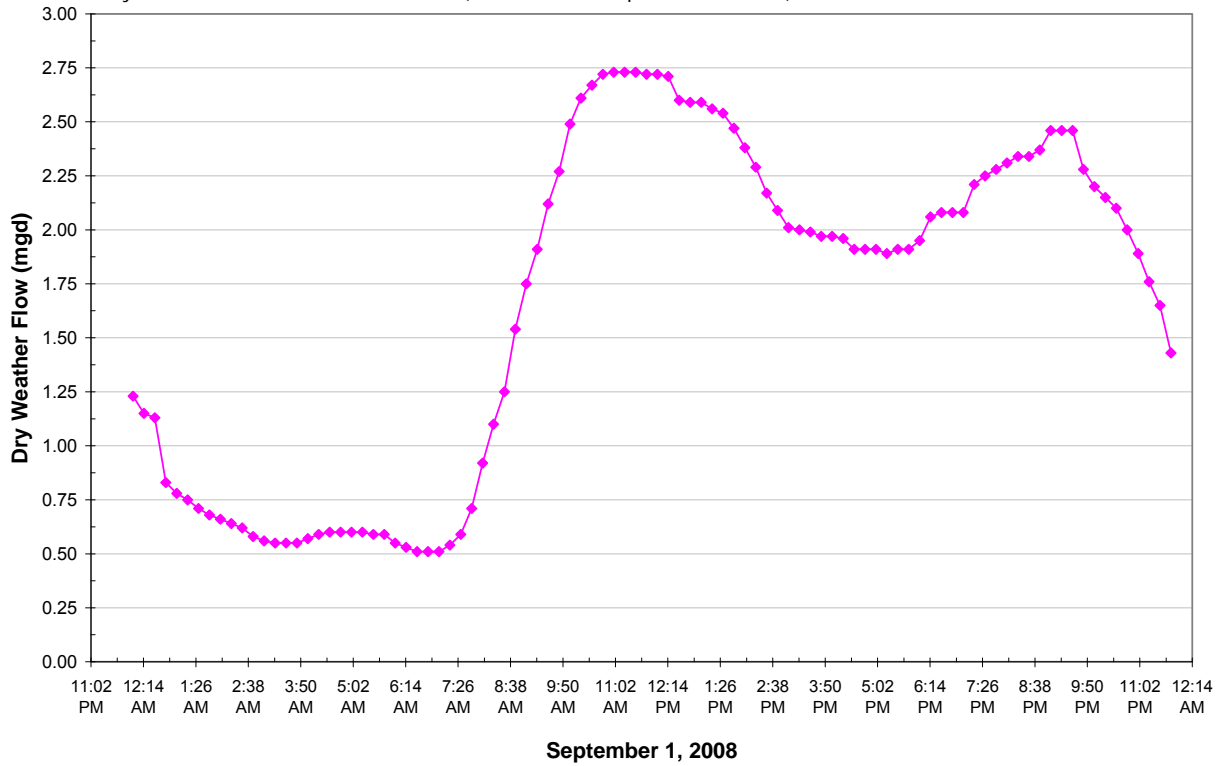
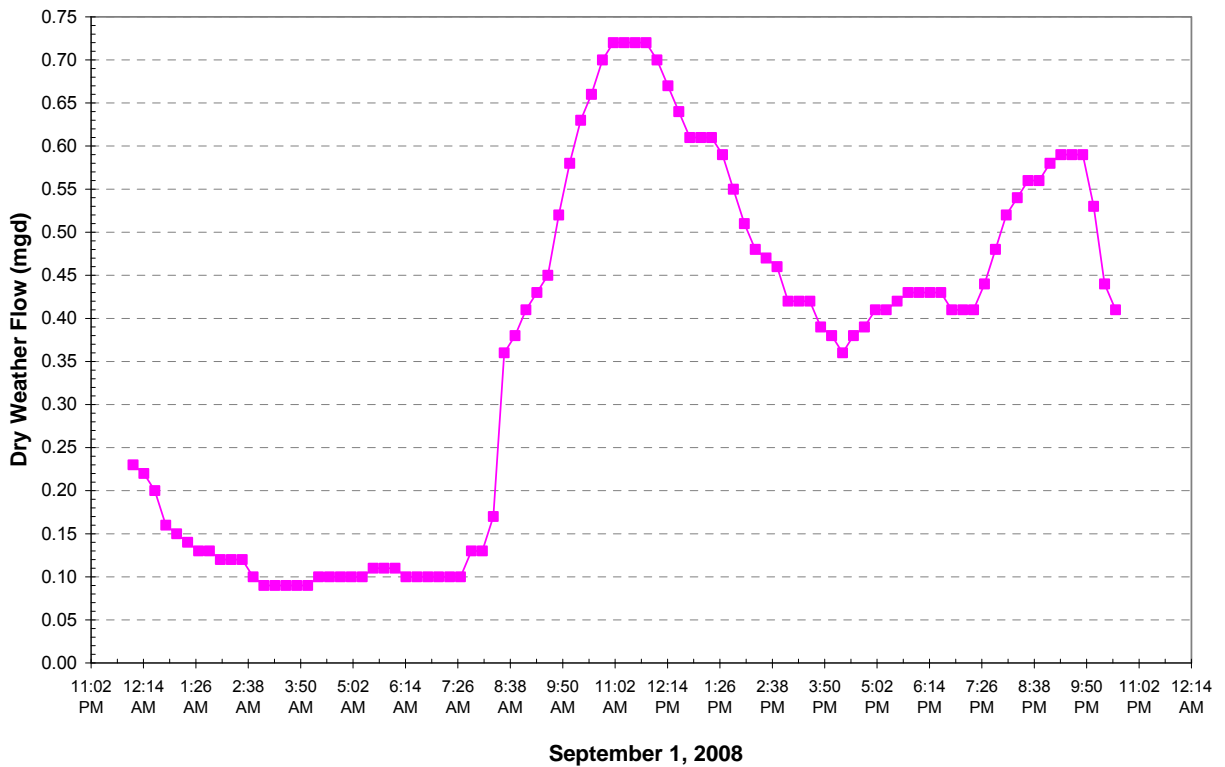

FIGURE 3-8
Maximum Dry Weather Flow in the South Trunk (Recorded on September 1, 2008)



According to the flow data shown in Figures 3-5 through 3-8, the peak flow generally occurs around late morning; and the lowest flow is observed between midnight and the early morning hours. The flow patterns presented in Figures 3-9 and 3-10 are in agreement with those typically observed in wastewater treatment facilities that primarily treat domestic sewage.

Using the equation below, the peaking factor was developed based on the ratio of the peak-hour flow and the average dry weather flow for the entire system that included the North and South Trunk lines:

$$\text{Sustained Peaking Factor (PF)} = \frac{\text{peak Hourly Flowrate}}{\text{Average Longterm Flowrate}} \quad (\text{Metcalf \&Eddy, 2004})$$

Where,

Peak hourly flow is the average of the peak flows sustained for a period of 1 hour during the evaluation period

Average long-term flow rate is the average flow rate over a defined period (such as, 1 year, 3 years)

The average long-term flow rate in the equation was replaced with the average dry weather flow because of the limited influent flow data. Where flow rates are available, at least 3 years of data are analyzed to define the peak to average day peaking factor. The average dry weather flow (ADWF) is the average of the daily flows sustained during dry weather periods with limited infiltration. For the purpose of this TM, the ADWF was determined as the average of the average daily flows from August 7 through October 13, 2008.

In the North Trunk, the peak hourly wet weather flow on November 27, 2008, was 3.32 mgd, which lasted for 1 hour. On the same day, the peak hourly wet weather flow in the South Trunk was 0.87 mgd, which lasted for 1 hour. The wet weather peaking factor for the system was then calculated as the ratio between the peak hourly wet weather flow of 4.2 mgd (the sum of the peak hour wet weather flows in both trunk lines) and the ADWF of 1.78 mgd (Figure 3-9). The system dry weather peaking factor was calculated in a similar manner (Figure 3-10).

FIGURE 3-9
System Maximum Wet Weather Flow and Wet Weather Peaking Factor (Recorded on November 27, 2008)

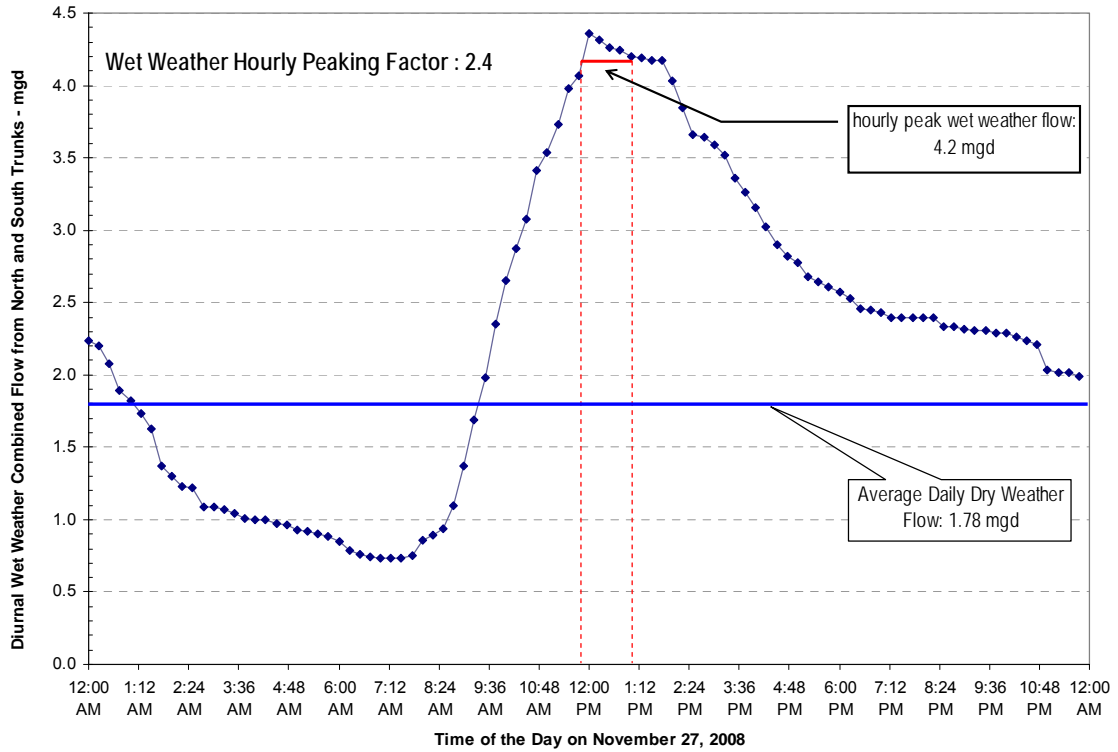

FIGURE 3-10
System Maximum Dry Weather Flow and Dry Weather Peaking Factor (Recorded on November 27, 2008)

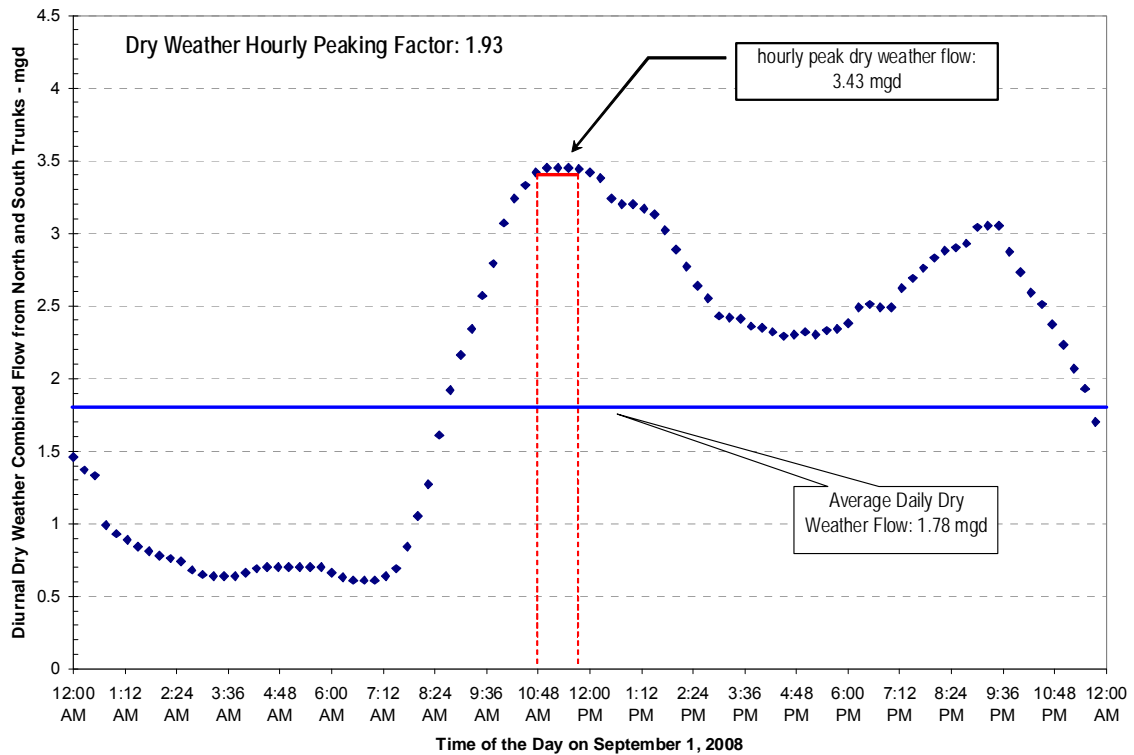

Table 3-2 summarizes the ADWF, wet weather, and dry weather peaking factors.

TABLE 3-2
Plant Dry and Wet Weather Flows and Peaking Factors

Condition	North Trunk	South Trunk	System Total
Maximum Peak Hour Wet Weather Peak Flow – mgd	3.32	0.87	4.20
Maximum Peak Hour Dry Weather Peak Flow – mgd	2.72	0.71	3.43
Average Dry Weather Flow (ADWF) – mgd	1.49	0.29	1.78
Dry Weather Peaking Factor based on ADWF	--	--	1.93
Wet Weather Peaking Factor based on ADWF	--	--	2.40

Notes:
 Dry Weather: August 7 to October 13, 2008
 Wet Weather: October 14, 2008, to June 11, 2009
 System Maximum Day Dry Weather: September 1, 2008
 System Maximum Day Wet Weather: November 27, 2008
 Flow Evaluation Period: August 7, 2008, to June 11, 2009

The peaking factors presented in Table 3-2 are based on limited flow data measured between August 7, 2008, and June 11, 2009. Based on this limited information, the wet weather peaking factor of 2.40 was estimated and considered to be used for the LCSD Facility Master Plan. The flow data were also monitored in April, May, and the first part of June 2009. However, the data still indicated a relatively high flow period (see Figures 3-3 and 3-4).

Table 3-3 summarizes the calculated average flow, dry weather average flow, and wet weather average flow for the evaluation period.

TABLE 3-3
Average Flows during August 2008 to March 2009

Condition	North Trunk	South Trunk	System Total
Average Flow during the Evaluation Period– mgd	1.65	0.34	1.99
Average Dry Weather Flow (ADWF) – mgd			1.78
Average Wet Weather Flow (AWWF) – mgd			2.05

Notes:
 Flow Evaluation Period: August 7, 2008, to June 11, 2009

According to the new flowmeter readings, the average flow to the treatment plant was approximately 1.99, with an average flow of 1.65 mgd from the North Trunk and average flow of 0.34 mgd from the South Trunk during the evaluation period.

The *Draft Sewer Collection Master Plan* recommended peaking factors for gravity sewer design (Penfield and Smith, 2009). The peaking factors are presented in Table 3-4.

TABLE 3-4
Recommended Peaking Factors for Gravity Sewer Design

Condition	Peaking Factor
Maximum Day Dry Weather	1.6
Peak Hour Dry Weather	2.4
Peak Hour Wet Weather	Not Analyzed

Source: Penfield and Smith, 2009

The peaking factor of 2.4 was based on the maximum day historical factor of 1.59 (December 2007), and the diurnal peak that was recorded during the flow study of two flowmeters (MH 1861 in the North Trunk and MH 1816 in the South Trunk) during a 3-week period in 2008. The peaking factors shown in Table 3-4 were recommended for individual development of the sewer system design.

3.2 Historical Raw Wastewater Characterization

Plant data records containing daily and monthly values for parameters tested from 2006 through 2008 were used to define the raw wastewater quality.

The plant influent quality is characterized as high-TDS and low-TDS flow streams. The WWRP influent high TDS is attributed to regenerating water softeners in homes in the Santa Maria and Orcutt areas. The brine used to recharge these softeners enters the wastewater stream, causing a high-TDS flow that generally reaches the plant between 5:00 a.m. and 10:00 a.m. To reduce TDS in the final effluent, the high-TDS stream is treated separately. The capacity of the high-TDS treatment train is 0.5 mgd. TDS is monitored in samples collected from the high-TDS Basin, whereas the quality of the low-TDS stream is monitored at Pond A (also referred to as ZeeWeed® Feedwater). Figure 3-11 shows the TDS concentrations in the high- and low-TDS streams.

FIGURE 3-11
TDS Concentration in the High-TDS and Low-TDS Flow Streams at the WWRP

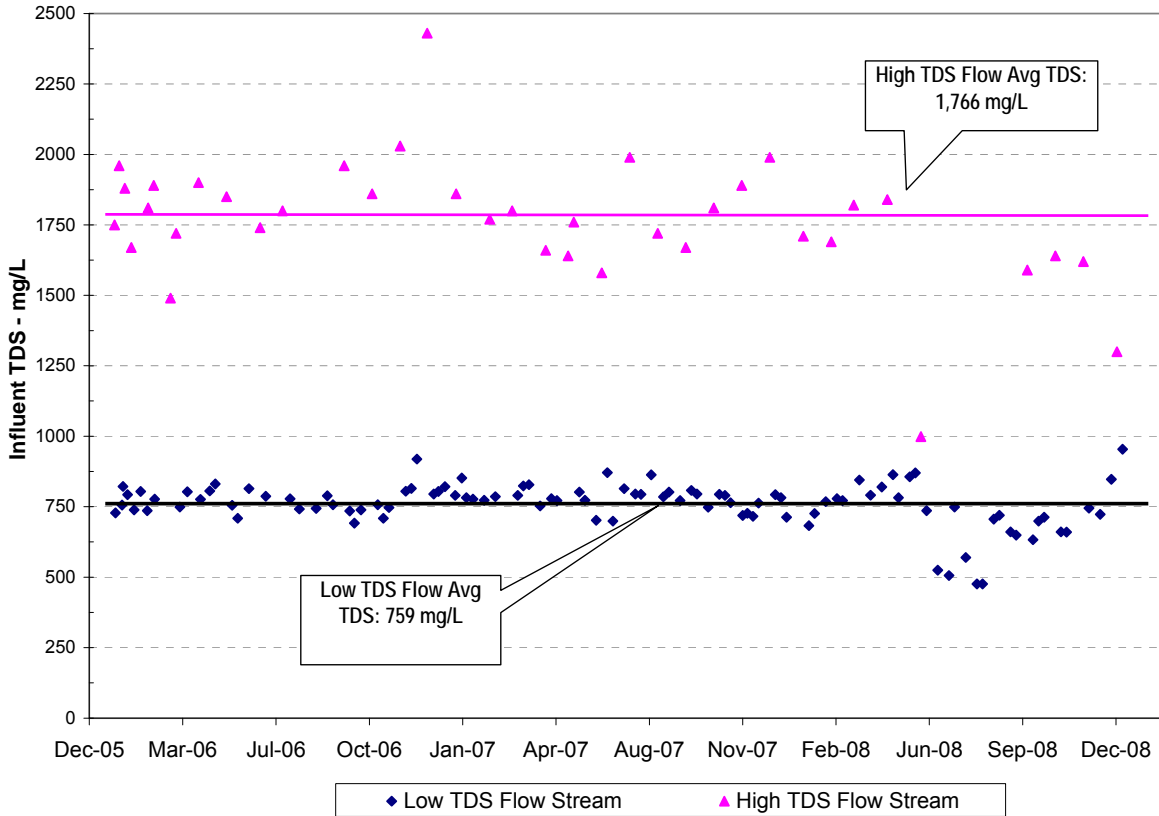

TDS does not typically change during treatment; therefore, TDS samples collected from the WWRP can reflect raw wastewater TDS values. Currently, LCSD is trying to enforce the use of canister exchange water softeners to eliminate high-TDS loads to the WWRP. If this approach is approved by the community, it will reduce TDS loads to the plant.

Los Angeles Sanitation District recently enforced the Santa Clara River Chloride Reduction Ordinance in the Santa Clarita Valley. The ordinance prohibits the use of residential automatic (self-regenerating) water softeners that use either sodium chloride or potassium chloride for regeneration. The ordinance was approved in November 2008 and taken into effect on January 1, 2009. Effective June 30, 2009, all residential automatic water softeners whether they are rented or owned have to be switched to nonregenerated types.

The plant influent biochemical oxygen demand (BOD) and total suspended solids (TSS) concentrations during 2006 to 2008 are presented in Figure 3-12.

FIGURE 3-12
Historical Plant Influent Monthly Average BOD and TSS Concentrations

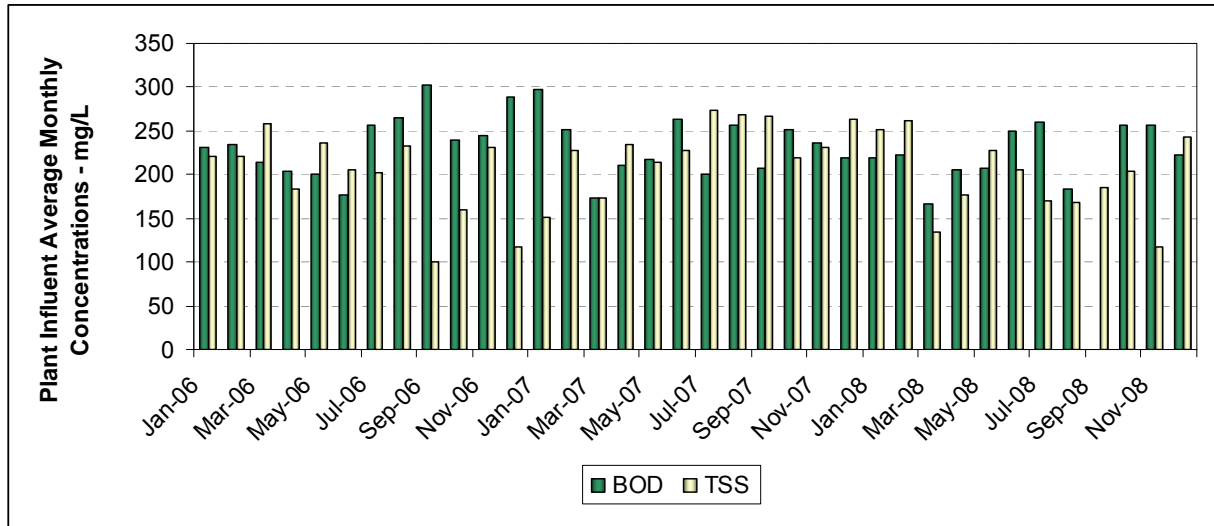

Table 3-5 summarizes the plant influent annual average and maximum concentrations of BOD, TSS, and chemical oxygen demand (COD). According to Table 3-5, a 3-year average concentration of BOD and TSS is approximately 232 and 210 milligrams per liter (mg/L), respectively. The average BOD and TSS concentrations in Table 3-5 indicate a medium-strength wastewater (Metcalf & Eddy, 2004).

TABLE 3-5
Plant Influent Quality

Year	BOD (mg/L)		TSS (mg/L)		COD (mg/L)	
	Average	Max	Average	Max	Average	Max
2006	238	303	206	258	570	827
2007	232	297	229	273	547	611
2008	225	260	195	262	513	606
Average	232		210		543	

Table 3-6 presents the plant influent BOD and TSS loads in pounds per day (lb/d) based on average influent flows derived from Figure 3-1 and average concentrations data derived from Figure 3-11 recorded during 2006 and 2008.

TABLE 3-6
Plant Influent Flow and BOD and TSS Loads

Year	Average Influent Flow (mgd)	Average BOD Load (lb/d)	Average TSS Load (lb/d)
2006	1.8	3,651	3,026
2007	1.9	3,107	3,068
2008	2.0	3,607	3,163

LCSD recently conducted a composite sampling campaign to fill the water quality data gap for influent ammonia, alkalinity, total Kjeldahl nitrogen (TKN), volatile suspended solids (VSS), and orthophosphate concentrations. During the sampling campaign, BOD and TSS samples were also collected to compare the recent BOD and TSS data with the historical data. The testing results and average values of three measurements are presented in Table 3-7.

TABLE 3-7
Recent WRP Influent Water Quality Data

Date	Unit	Total Ammonia (as N)	TKN	Ortho-phosphate (as P)	Alkalinity as CaCO ₃	Total BOD ₅	TSS	VSS
04/21/09	mg/L	31	46	3.5	318	230	216	197
05/06/09	mg/L	29	38	3.2	330	241	246	215
05/20/09	mg/L	28	68 ^a	2.6	332	243	226	205
Average		29	42	3.1	327	238	229	206

Notes:

^a Identified as an outlier and therefore not included in the average calculation.

TKN: Total Kjeldahl Nitrogen

VSS: volatile suspended solids

The influent ammonia concentrations measured in 3 days in April and May 2009 were consistently around 29 mg/L whereas TKN concentrations were widely varied. Ammonia-to-TKN ratio in a typical municipal wastewater influent is between 0.6 and 0.75 (Metcalf & Eddy, 2004). Based on this ratio and average ammonia-N concentration of 29 mg/L, the expected TKN concentration is between 38 and 48, which suggests that the TKN value of 68 mg/L is an outlier and therefore was excluded in the average calculations.

The recent BOD and TSS concentrations were within the range of historical BOD and TSS data (Table 3-5). For modeling and sizing of the unit treatment facilities that will be performed in TM 4, the average BOD and TSS values (232 and 210 mg/L) derived from Table 3-5 will be used. The plant influent orthophosphate concentrations were consistent with the levels normally observed in a low- to medium-strength wastewater (Metcalf & Eddy, 2004).

3.3 Historical Effluent Quality

LCSD has controlled TDS in the effluent via water source management and effluent management (Community of Orcutt, 1997). The effluent management has been addressed by separate treatment of high- and low-TDS flow streams. Figure 3-13 illustrates the annual average concentrations of TDS and salts species in the effluent during 2006 and 2008.

FIGURE 3-13
Plant Effluent Average TDS, Sodium, Chloride, and Sulfate Concentrations

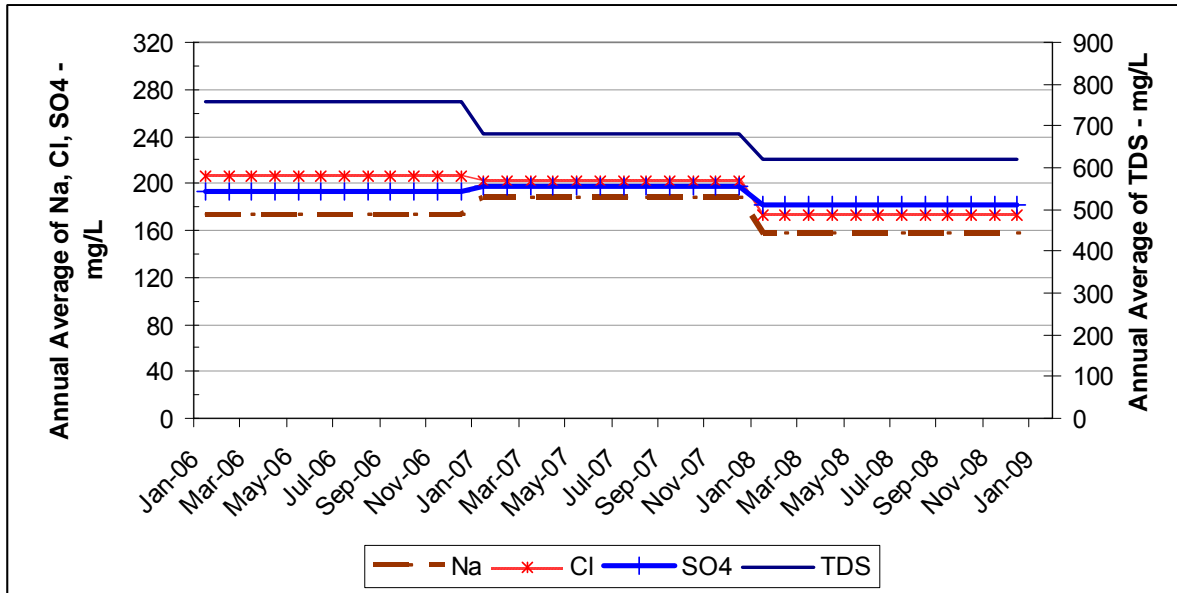

The annual average TDS was consistently reduced from its upper level of 700 mg/L to approximately 600 mg/L. The 2008 annual average TDS was well below the TDS permit limit of 900 mg/L. The concentrations of sodium and sulfate fluctuated over the 3 years but were the lowest in 2008 and below the respective sodium limit of 180 mg/L and sulfate limit of 300 mg/L in 2008. Although a slight (but consistent) reduction in chloride concentration was observed, the 2008 annual average chloride concentration of 173 mg/L was above the permit limit of 150 mg/L. The reported data from April and May 2009, however, showed further reduction in effluent chloride concentrations of 140 mg/L and 160 mg/L, respectively.

If the plant effluent quality is not in compliance with the first tier WDRs requirements (Table 2-1) but meets the second tier WDRs (Table 2-2), about 25 percent of the plant discharge is sent to the local farmers; a small percentage is sent to an oil company, and the rest is used for spray irrigation on the pastureland surrounding the plant.

4.0 Flows Projections

The Orcutt area is divided into residential neighborhoods and key sites. A key site is a vacant and underdeveloped area, generally larger than 3 acres. The OCP indicated 21 residential neighborhoods and 43 key sites, each identified as areas having the greatest potential for development in the future (Penfield and Smith, 2009). Residential development represents the predominant land use in the Community of Orcutt with 97 percent of the existing housing in the single-family category (CH2M HILL, 2006). The Orcutt area average annual population growth was 4.1 percent between 1980 and 1990. An average annual growth of 2.5 percent was expected between 1990 and 2020. After 2030, the service area is assumed to have reached a near build-out condition with minimal housing development projects after 2030. The following sections discuss the population growth and wastewater generation projected for the LCSD service area by previous planning studies.

4.1 Population Projections

The historical and projected population and number of households within the Orcutt service area based on the build-out data in the OCP (1997) are compared with the 2005 Urban Water Management Plan (UWMP) projected population and wastewater generation (CH2M HILL, 2006) in Table 4-1.

TABLE 4-1
Orcutt Service Area Historical and Projected Population and 2005 UWMP 30-Year Population and Wastewater Flow Projections

Year	1997 Orcutt Community Plan		2005 Urban Water Management Plan	
	Service Area Population	Service Area Household	Projected Population in Service Area	Wastewater Collected and Treated in Service Area*
1998	27,263	9,950	--	--
2000	27,654	10,093	27,682	2.2 mgd
2005	29,577	10,795	29,189	2.3 mgd
2010	31,499	11,496	30,696	2.5 mgd
2015	33,003	12,045	32,738	2.7 mgd
2020	34,508	12,594	34,779	2.8 mgd
2025	35,257	12,888	34,779	2.8 mgd
2030	36,006	13,141	34,779	2.8 mgd

Notes:

* The wastewater flows are based on a wastewater generation rate of 80 gallons per day (gpd) per capita.

The annual growth rate predicted in the 1997 OCP is 0.9 to 1.4 percent between 2000 and 2020 with only 0.4 percent growth between 2020 and 2030. The 2005 UWMP predicts a maximum annual growth of 1.3 percent between 2000 and 2020, and no population growth

between 2020 and 2030. Projected growth rates in the 1997 OCP and 2005 UWMP are both lower than the annual growth rate (2.5 percent) mentioned earlier.

The 2005 UWMP wastewater rates were calculated based on the LCSD per capita wastewater generation factor of 80 gallons per day (gpd) generated by the population using the system.

According to the LCSD 2008 Tax Records, the population in the service area was recorded as 31,184. The total existing connections in the service area were 11,700 of which the residential connections, representing 99 percent of the total connections, were 11,507 (single-family homes accounted for 8,866 and multifamily homes accounted for 2,641). The remaining 1 percent of the accounts was composed of commercial/industrial (C/I) users including schools, churches, parks, and agriculture. The number of residents per household as reported in the Census was 2.71 (Penfield and Smith, 2009).

A comparison between the population and household connections in 2010 (Table 4-1) and the 2008 records indicates a faster population growth than expected. On the other hand, the 2005 UWMP projections do not indicate population growth after 2020.

4.2 Return to Sewer Rates

The Penfield and Smith (2009) Draft Sewer Collection Master Plan reported the data from a flow metering study that included nine manholes located in nine different neighborhoods in Orcutt. Based on this study, which was performed from June 16 to July 25, 2008, the average day duty factors (that is, the return to sewer generation rates) for the LCSD customer connections were determined. Table 4-2 presents the average day sewer duty factors.

TABLE 4-2
Average Day Sewer Duty Factors

Service Type	Unit	2009 Projected Duty Factor
Single Family	gpd per connection	220
Multi-Family	gpd per connection	155
Mixed-Use Commercial	gpd per acre	1,400
Professional	gpd per acre	420
Church	gpd per acre	300
Parks and Open Space	gpd per acre	27

Source: Penfield and Smith, 2009

Residential sewer duty factors were determined by distributing flow throughout the system on a per-connection basis. Tax records provided by LCSD were used to account for every active service at the time of the study. Commercial sewer duty factors were calculated based on the water meter data provided by LCSD.

The study concluded that the duty factors calculated for the study were lower than the existing LCSD sewer duty factors. The results indicated different usage characteristics per household due to a number of factors (for example, conserving fixtures in newer areas, household densities, and wastewater exfiltration from old clay pipes). The residential usage

rates were more representative of peak flow from a small planning area such as a single housing connection. The commercial rates showed the largest discrepancy.

The duty factors established for this *Draft Sewer Collection System Master Plan* are intended to be used for planning purposes and formation of the development impact fee structure for the OCP (Penfield and Smith, 2009).

4.3 Wastewater Flow Projections

Table 4-3 presents the existing and future wastewater flow projections recommended by Penfield and Smith (2009). The future developments in the area were assumed to include full implementation of the OCP, additional possible developments within the OCP boundary including septic-to-sewer conversions and larger lots, and Santa Maria Public Airport District. The flow projections were based on the assumptions that the LCSD service area would extend beyond the OCP boundary shown in Figure 1-2, incorporating portions of the city of Santa Maria.

TABLE 4-3
Existing Flows and Future Wastewater Flow Projections

Condition	Average Daily Flow (mgd)			Maximum Daily Flow (mgd)		
	North Trunk	South Trunk	System Total	North Trunk	South Trunk	System Total
Existing ^a	1.66	0.54	2.2	2.66	0.86	3.5
Approved	1.67	0.73	2.4	2.67	1.21	3.9
Future ^b	2.64	1.16	3.8	4.18	1.85	6.0
Future + Infill	3.16	1.24	4.4	4.98	1.99	7.0

Notes:

^a Existing flow data were based on flow data monitored by Fluid Resource Management from June 16 to July 25, 2008.

^b Because the future date was not specified in the study, it is assumed that the future is year 2030.

Source: Penfield and Smith, 2009

In Table 4-3, the “approved” condition represents sewer demand from all currently approved development, and accounts for all new homes currently constructed but not occupied. “Future” values account for all potential customers to the existing wastewater treatment plant including the future flows from the current city of Santa Maria Swap Agreement.

Table 4-4 shows the wastewater flow projections presented in the 1997 and 2002 Orcutt Community Plans.

TABLE 4-4
 LCSD Plant Capacity and Demand (Orcutt Community Plan, 1997)

Condition	Units	Demand (mgd)	C/I (sf)	Demand (mgd)	Total (mgd)
Existing Capacity	11,000	2.2	609,000	0.34	2.54*
Orcutt Community Plan	3,100 additional	0.62	2,589,445	1.48	2.1
Total Build-out Demand (existing + plan)	14,100	2.82	3,198,445	1.82	4.64*
Plant Capacity					3.2
Permitted capacity (75% of Plant Capacity)					2.4
Permitted Capacity Deficit (Build-out)					2.24

* This figure is higher than actual treatment levels as it does not subtract for vacant houses and vacant C/I space. 1996 treatment levels were just under 2.4 mgd (OCP, 1997).

Source: Orcutt Community Plan (1997)

Based on the anticipated development in the Orcutt community, the projected wastewater flow was estimated to be 4.64 mgd (Table 4-4). It was, however, noted in the report that the full build-out of the proposed plan especially in the C/I category was not anticipated to occur in 2017 or later. The wastewater flow projections from the previous planning studies are compared in Figure 4-1.

FIGURE 4-1
 Summary of the Wastewater Flow Projections

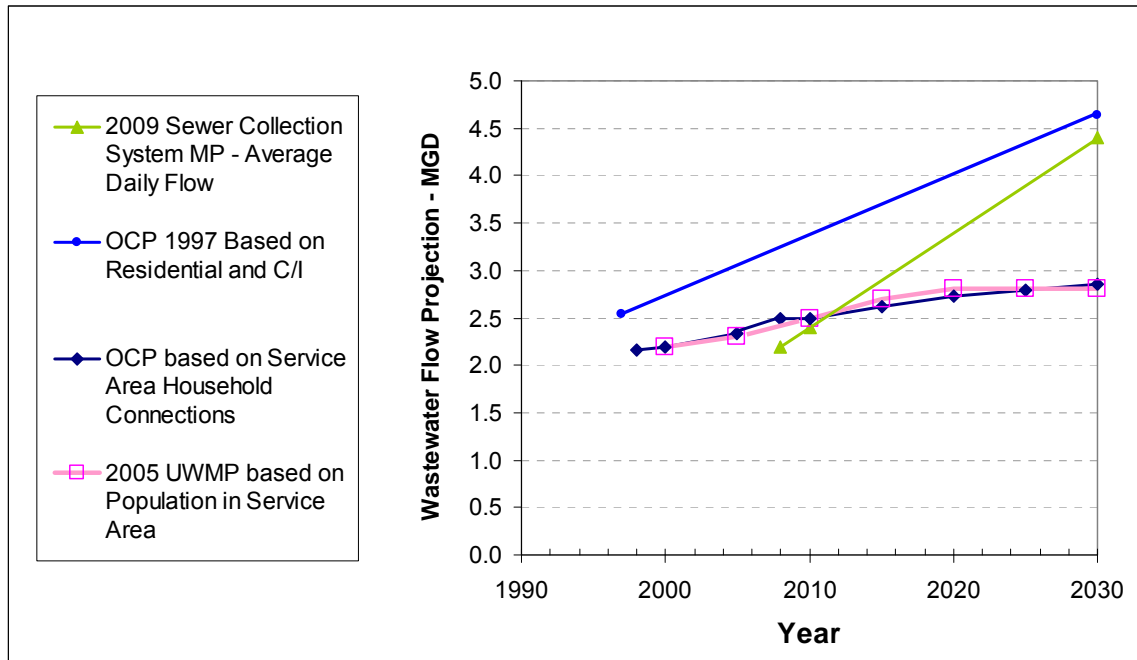

In Figure 4-1, the population-based wastewater flow projections for the OCP service area household connections were calculated based on the Census value of 2.71 people per household and the LCSD wastewater generation factor of 80 gpd per capita and were compared to the 2005 UWMP wastewater flows projections. The “Future+Infill” average daily flows (Table 4-3) in the 2009 *Draft Sewer Collection System Master Plan* were used to show the anticipated flows from all categories. The “Future” was assumed to be 2030. These flows were then compared with the 1997 OCP total build-out demand flow (Table 4-4). The 2009 *Draft Sewer Collection System Master Plan* flow projection for 2030 included the Swap agreement with the city of Santa Maria that ends in 2017.

The flow projections based on OCP household connection (the dark blue line) and 2005 UWMP (the pink line) are significantly lower than those projected by the 2009 Sewer Collection System (the olive green line) and OCP Residential with C/I (the light blue line). For planning purposes, using the largest flow rate for sizing future plant facilities is a reasonable approach. Therefore, the projected average total flow for 2030 including both residential and C/I will most likely be around 4.64 mgd (blue line). The projected 4.64-mgd future flow does not include any industrial and nonresidential discharges that will be incorporated into the sewer system in the future.

The District recently reported that a new jail will be established in the LCSD service area. The new jail will be located in the southwest corner of Betteravia Road and Black Road. The initial wastewater flow was estimated to be 36,000 gpd with phases adding 59,000 gpd and another 83,000 gpd for a total of 178,000 gpd or approximately 0.2 mgd. In addition, the flow and TDS measurements from Semco (Waller) flow metering station manhole indicated a high-TDS flow of approximately 10,250 gallons per hour with a 6-hour duration. This high-TDS stream will be diverted from the City of Santa Maria Plant to LCSD WWRP for treatment in the future. This will add approximately a 62,000-gallon flow that needs to be treated in the future.

The flow projections shown in Figure 4-1 did not include these additional flows. Taking into account all the additional flows, an average total daily flow of 5.0 mgd is recommended for sizing future treatment facilities. Table 4-5 presents the WWRP future flow projections.

TABLE 4-5
Future Plant Flow Projections in 2030

Condition	Flow (mgd)
Average Design Flow	5.0
Peak Dry Weather Flow	9.6
Peak Wet Weather Flow	12.0

For sizing future hydraulic components of plant facilities such as bar screens, grit removal, influent piping, and conveyance structures, the plant needs to be designed using peak wet weather flow of 12.0 mgd. A safety factor of 1.2 will be applied for sizing of the hydraulic components.

5.0 Future Discharge Regulations

Anticipated and potential future regulations applicable to the facilities planning for the WWRP are discussed in this section.

5.1 Title 22 Requirements

Per Title 22, reliability features in the treatment facilities are required to ensure safe performance. Currently, some of the unit processes, such as the trickling filter and the secondary clarifier, have no redundancy, which could result in a significant interruption in plant operations. Aging of the existing infrastructure is also an important factor that needs to be considered in maintaining a safe operation and plant performance.

5.2 Disinfection By-Products and Emerging Contaminants

The CDPH is constantly reviewing the ongoing research on disinfection by-products (DBPs) and emerging contaminants that can be found in wastewaters. The most recent CDPH Groundwater Recharge (GWR) regulations set an action limit of 10 nanograms per liter (ng/L) for nitrosodimethylamine (NDMA) and recommended monitoring of up to 25 emerging contaminants in GWR projects. Although these compounds are yet to be regulated, some or all monitored contaminants will more likely be regulated in the future. Therefore, it is necessary to take a closer look at the performance of the biological treatment units and the need for advanced tertiary treatment. In addition, controlling of nitrogen-containing compounds (specifically nitrate-nitrogen) in reuse projects is the focus of the regulatory agencies, indicating that certain reuse projects might require partial reduction in nitrogen loads. Therefore, future plant expansion should consider treatment options, or maintain sufficient flexibility to comply with more stringent future discharge regulations.

5.3 New Recycled Water Policy

The new recycled water policy that was adopted by SWRCB on May 14, 2009, may shape the future regulations for the reclamation plant. The intent and purpose of this policy will:

- Support the SWRCB's strategic plan to increase sustainable local water supplies
- Provide direction to the RWQCBs, proponents of recycled water projects, and the public to increase the beneficial use of recycled water from municipal wastewater sources in a manner that fully implements state and federal water quality laws
- Include a consistent salt/nutrient management plan for every groundwater basin/sub-basin in California

The salt and nutrient plans under the new recycled water policy must focus on basin water quality near water supply wells and areas close to large water recycling projects, particularly GWR projects and are required to address the following:

- Water quality concerns and constituents other than salt and nutrients that impact water quality in the basin/sub-basin.
- Identification and implementation provisions, as appropriate, for all sources of salt and/or nutrients to groundwater basins, including recycled water irrigation projects and groundwater recharge reuse projects.
- A basin/sub-basinwide monitoring plan that can adequately provide a reasonable, cost-effective means of determining whether the concentrations of salt, nutrients, and other constituents of concern are consistent with applicable water quality objectives. The frequency of the monitoring plan should be included in the plan and will be approved by the RWQCB.
- Annual monitoring of Emerging Constituents/Constituents of Emerging Concern (e.g., endocrine disrupters, personal care products, or pharmaceuticals) (CECs) consistent with recommendations by CDPH and SWRCB.
- Salt and nutrient source identification, basin/sub-basin assimilative capacity and loading estimates, together with fate and transport of salts and nutrients
- Water recycling and stormwater recharge/reuse goals and objectives

It is required that salt and nutrient plans be completed and proposed to the RWQCB within 5 years from the date of this Policy unless a RWQCB finds that the stakeholders are making substantial progress towards completion of a plan. The completion of a plan should not exceed 7 years. Within 1 year of the receipt of a proposed salt and nutrient management plan, the RWQCBs shall consider for adoption revised implementation plans, consistent with Water Code section 13242, for those groundwater basins within their regions where water quality objectives for salts or nutrients are being, or are threatening to be, exceeded. SWRCB will soon assign an advisory panel that will identify actions related to the use of recycled water regarding the CECs. The results are expected to be available in 1 year.

5.4 Conditional Letter of Map Revision

Reliable monitoring of the plant flows will be necessary to provide a better facility planning and future design. Prior to future facilities planning and construction, studies of hydrology and hydraulics are needed to ensure that the floodplain will not be affected. New developments and expansions must be above the 100-year flood to comply with the requirements of the National Flood Insurance Program (NFIP) and the floodplain management ordinance of the site. If the floodplain is affected, a Conditional Letter of Map Revision (CLOMR) would need to be obtained. The reclamation plant is located on a Special Flood Hazard Area (SFHA). Appendix C presents the Federal Emergency Management Agency (FEMA) issued map No. 06083C0170F, which shows the location of the plant on the 100-year floodplain.

6.0 Summary and Conclusions

The purpose of this TM is to assist the District to evaluate current plant flows and raw wastewater quality, and to estimate flow peaking factors and future plant flows. In addition, the information summarized in this TM will serve as a basis for TM 2 (Alternative Screening) and TM 3 (Alternative Evaluation and Selection).

The current plant flow conditions were evaluated based on recent flow monitoring in the North and South Trunk lines upstream of the plant during August 2008 to June 2009. The inaccuracy of flowmeter readings before August 2008 limited the data to a 10-month period. Estimated plant flow and peaking factors are summarized in Table 6-1.

TABLE 6-1
Plant Dry and Wet Weather Flows and Peaking Factors

Condition	System Total
Average Dry Weather Flow – mgd	1.78
Dry Weather Peaking Factor	1.93
Wet Weather Peaking Factor	2.40

The raw wastewater and effluent quality were determined based on the 3-year historical data of the plant from 2006 to 2008 and 3-day sampling campaign. The raw wastewater quality that will be used in the forth-coming TMs is presented in Table 6-2.

TABLE 6-2
WWRP Current Raw Sewage Quality

Constituent	Concentration
Five-Day Biochemical Oxygen Demand (BOD5), mg/L	232
Total Suspended Solids (TSS), mg/L	210
Ammonia-N, mg/L	29
Total Kjeldahl Nitrogen (TKN), mg/L	42
Average Low Total Dissolved Solids (TDS), mg/L	767
Average High TDS, mg/L	1,758
Combined TDS, mg/L	910

The high-TDS flow is due to the use of regenerating water softeners by residential customers in the service area. Enforcing a Brine Ordinance to prohibit the use of home regenerating saltwater softeners in 1996 was legally challenged and not approved by the court. However, Los Angeles Sanitation District successfully enforced the Santa Clara River

Chloride Reduction Ordinance in the Santa Clarita Valley in 2008. The ordinance prohibits the use of residential automatic (self-regenerating) water softeners that use either sodium chloride or potassium chloride for regeneration. Effective June 30, 2009, all residential automatic water softeners whether they are rented or owned have to be switched to nonregenerated types. Therefore, LCSD is expecting no increase in high-TDS flows.

Considering the previous planning studies, the 2030 influent flow rate is projected to be 4.6 mgd. This projection does not include wastewater flows from recently planned establishments (a new jail and a research park). In addition, LCSD is expecting an additional 62,000-gpd high-TDS flow rate from the City of Santa Maria in the future. The projected average daily flow in 2030 is expected to be 5.0 mgd. Taking into account all the additional flows, an average total daily flow of 5.0 mgd is recommended for sizing future treatment facilities. The projected flow rates are summarized in Table 6-3.

TABLE 6-3
Future (2030) Plant Flow Projections

Condition	Flow (mgd)
Average Design Flow	5.0
Peak Dry Weather Flow	9.6
Peak Wet Weather Flow	12.0

The hydraulic components of plant facilities such as bar screens, grit removal, influent piping, and conveyance structures will be designed for the peak wet weather flow of 12.0 mgd. A safety factor of 1.2 will be applied for sizing of the hydraulic components. The projected future flows will be discussed with the LCSD and the design conditions will be further established in TM 3.

Future regulatory requirements may focus on partial reduction of nitrogen loads in certain reuse projects and regulate emerging contaminants in the GWR projects. Therefore, it is necessary to take a closer look at the performance of the biological treatment units and the need for advanced tertiary treatment. In addition, the new recycled water policy requires salt and nutrient management plans for groundwater basins and sub-basins in California. The salt and nutrient plans must focus on basin water quality near water supply wells and areas close to large water recycling projects, particularly GWR projects, and are required to frequently address the concentrations and loads of salt, nutrients, and other constituents of concern in monitoring plans. The monitoring plans should also include annual monitoring of CECs (e.g., endocrine disruptors, personal care products, or pharmaceuticals) to ensure consistency with CDPH and SWRCB recommendations.

A condition assessment of the existing WWRP unit processes and equipment was recently completed. The findings of this condition assessment, as well as the description of the reclamation plant, will be documented in a forthcoming memorandum.

7.0 References

CH2M HILL. 2001. *Wastewater/Reclamation Treatment Plant (WTRP) Conceptual Master Plan for Build Out to 7 mgd*. Final Draft. Prepared for Laguna County Sanitation District, County of Santa Barbara Public Works Department. February.

CH2M HILL. 2006. *2005 Urban Water Management Plan – Orcutt, Golden State Water Company, Region I Headquarters*. Prepared for Golden State Water Company, Region I Headquarters. Final Report. June 2006.

CH2M HILL. 2007. *Golden State Water Master Plan for Orcutt System*. Prepared for Golden State Water Company.

CH2M HILL. 2008. *Feasibility Study of Treated Wastewater Discharge Options*. Prepared for the Laguna County Sanitation District, County of Santa Barbara Public Works Department. May.

Community of Orcutt. 1997. *Orcutt Community Plan, Section G. Sewer, Board of Supervisors Final Plan*. July.

Laguna County Sanitation District, County of Santa Barbara Public Works Department. 2007. *Biosolids Annual Report for the Year 2007, Laguna County Sanitation District Wastewater Reclamation Plant*.

Metcalf & Eddy. 2004. *Wastewater Engineering Treatment and Reuse, Fourth Edition*.

Penfield and Smith. 2009. *Draft Sewer Collection Master Plan*. January.

Appendix A

Location of the New Flowmeters in North and South Trunk Lines

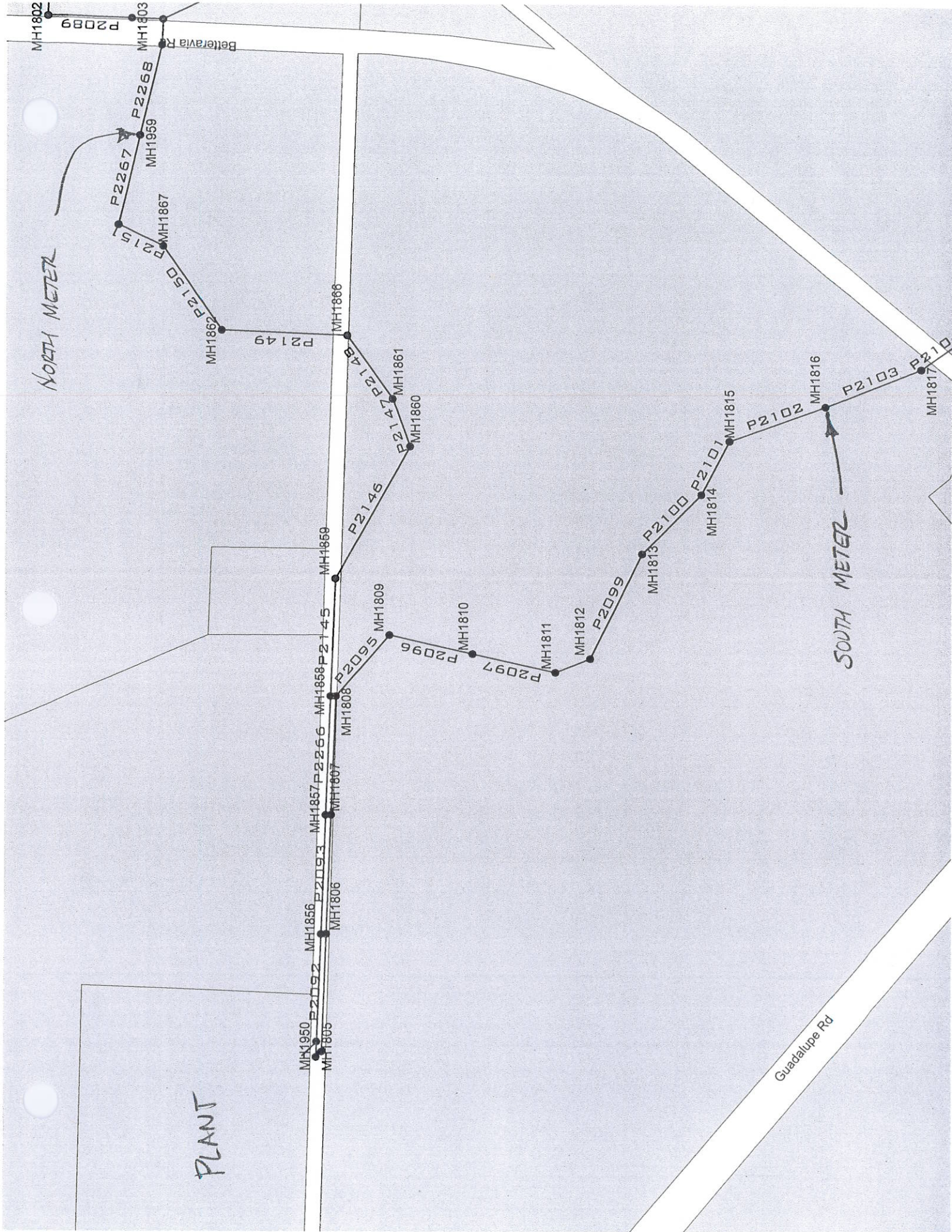

NORTH METER

SOUTH METER

PLANT

Guadalupe Rd

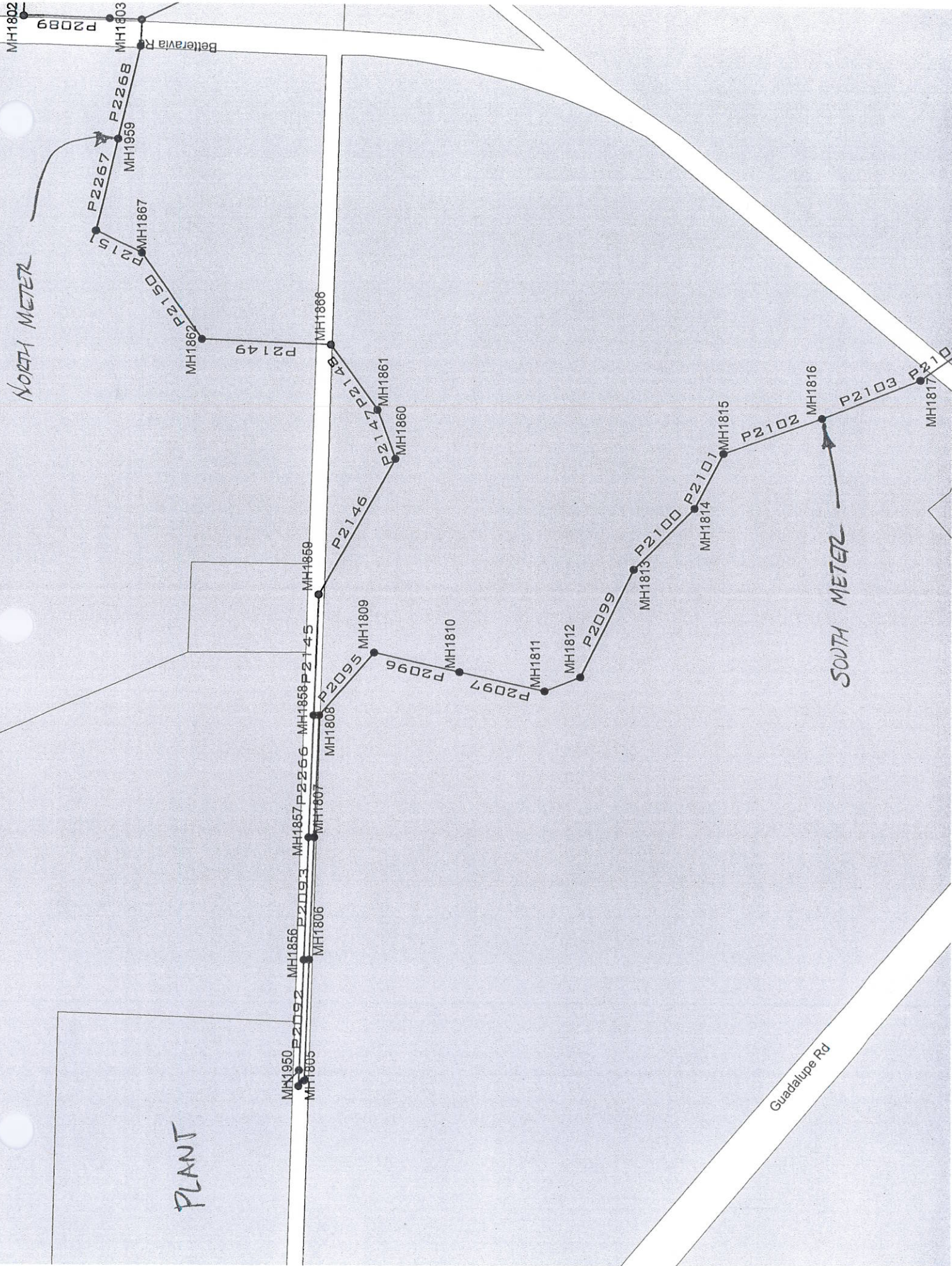

Appendix B

System Total Flow Data during August 2008 and March 2009

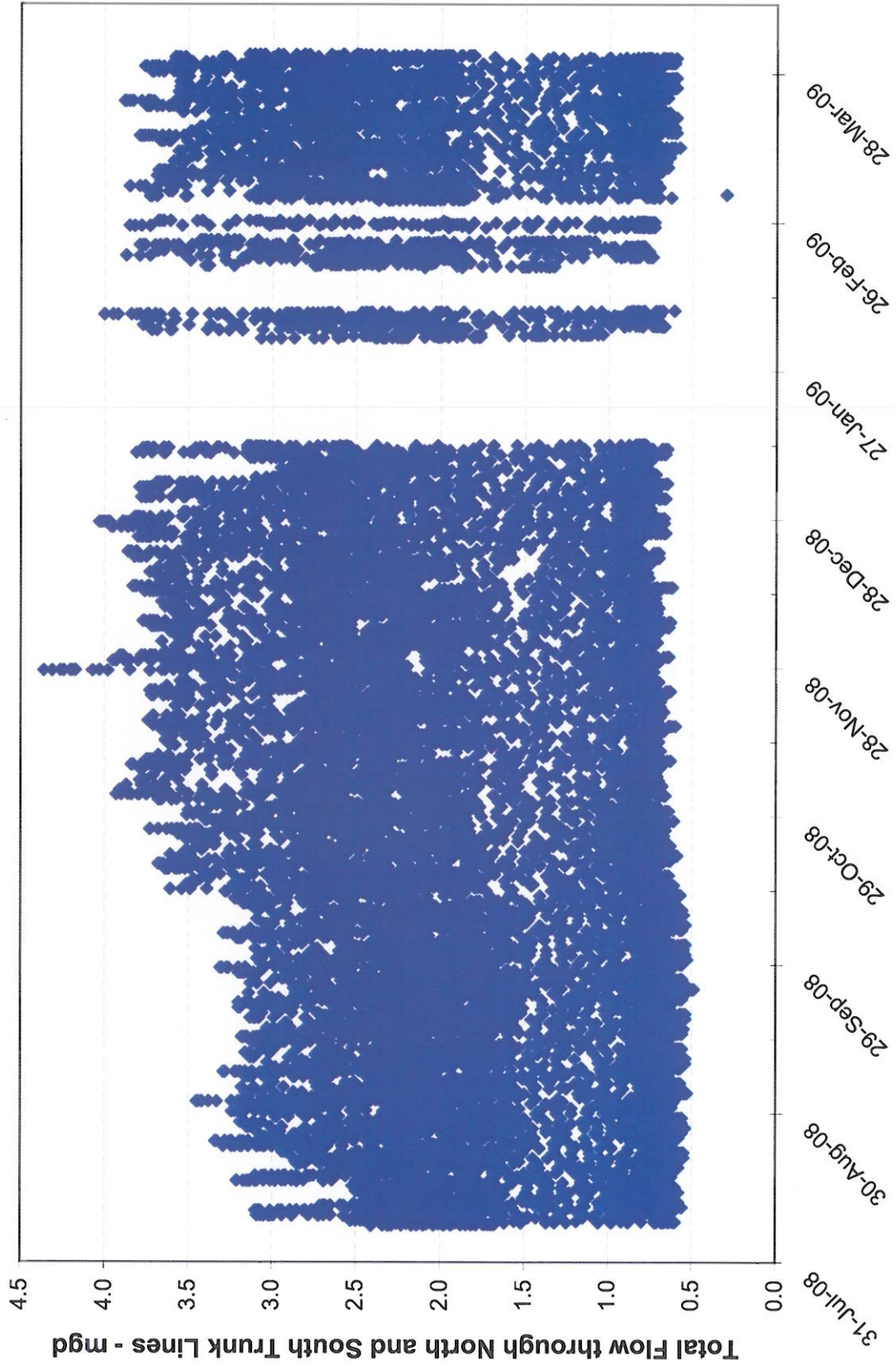

Appendix C
FEMA Flood Map No. 06083C0170

National Flood Insurance Program at 1-800-638-6622



MAP SCALE 1" = 1000'

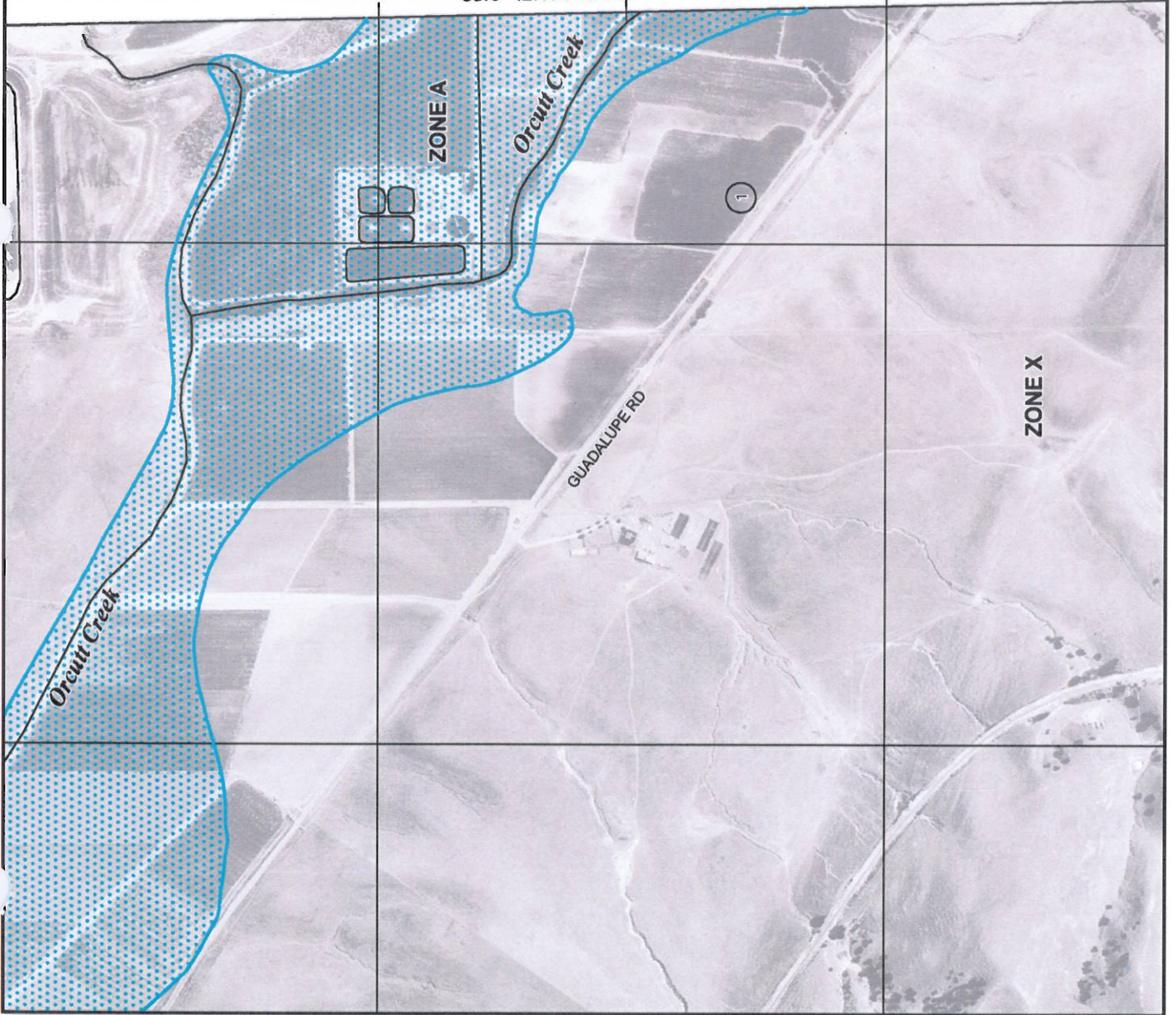

NATIONAL FLOOD INSURANCE PROGRAM

PANEL 0170F

FIRM
FLOOD INSURANCE RATE MAP
SANTA BARBARA COUNTY,
CALIFORNIA
AND INCORPORATED AREAS

PANEL 170 OF 1835

(SEE MAP INDEX FOR FIRM PANEL LAYOUT)

CONTAINS:

COMMUNITY NUMBER PANEL SUFFIX
SANTA BARBARA COUNTY 080331 0170 F

Notice to User: The map number shown below should be used in all correspondence with the insurance community. The map number shown above should be used on insurance applications for the subject community.



MAP NUMBER
060830070F

EFFECTIVE DATE
SEPTEMBER 30, 2005

Federal Emergency Management Agency

This is an official copy of a portion of the above referenced flood map. It was extracted using F-MIT On-Line. This map does not reflect changes or amendments which may have been made subsequent to the date on the title block. For the latest product information about National Flood Insurance Program flood maps check the FEMA Flood Map Store at www.msc.fema.gov

Laguna County Sanitation District Wastewater Reclamation Plant Condition Assessment

PREPARED FOR: Laguna County Sanitation District
 PREPARED BY: CH2MHILL
 DATE: July 21, 2010

Contents

Acronyms	iii
1.0 Introduction.....	1-1
1.1 Objectives.....	1-1
1.2 Condition Assessment Criteria.....	1-1
2.0 Description and Design Criteria of Wastewater Reclamation Plant Facilities.....	2-1
2.1 Headworks	2-2
2.2 Low TDS Liquid Treatment Train.....	2-4
2.2.1 Low TDS Pond.....	2-6
2.2.2 Primary Treatment	2-6
2.2.3 Secondary Treatment.....	2-6
2.2.4 Tertiary Treatment	2-7
2.3 High TDS Treatment Train	2-7
2.3.1 Fine/ Rotating Drum Screen	2-7
2.3.2 High TDS Pond.....	2-9
2.3.3 Membrane Bioreactor.....	2-9
2.3.4 Reverse Osmosis.....	2-9
2.4 UV Disinfection	2-10
2.5 Recycled Water	2-10
2.5.1 Recycled Water Pond.....	2-10
2.5.2 Recycled Water Pump Station	2-11
2.6 Solids Treatment.....	2-11
2.6.1 Anaerobic Digesters	2-11
3.0 Plant Condition Assessment Results.....	3-1
3.1 Introduction.....	3-1
3.2 Headworks	3-1
3.3 Low TDS Liquid Treatment Train.....	3-2
3.4 High TDS Liquid Treatment.....	3-6
3.5 Disinfection	3-8

3.6	Recycled Water	3-8
3.7	Solids Treatment.....	3-9
3.8	Building Structures.....	3-10
3.9	Plant Supervisory Control and Data Acquisition System	3-10
3.10	Yard Piping.....	3-10
4.0	Processes Performance Evaluation.....	4-1
4.1	Low-TDS Treatment Train	4-1
4.2	High-TDS Treatment Train	4-2
4.3	Solids Treatment.....	4-3
5.0	Conclusions	5-1

Appendices

A	LCSD Wastewater Reclamation Plant Field Observations Data Log
B	Photos of Wastewater Treatment Reclamation Plant
C	Photos of Wastewater Treatment Reclamation Plant Electrical System

Tables

2-1	Headworks Design Criteria	2-2
2-2	Low-TDS Liquid Train Design Criteria.....	2-4
2-3	High-TDS Liquid Train Design Criteria.....	2-8
2-4	UV Disinfection System Design Criteria.....	2-10
2-5	Recycle Water Pond and Pump Station Design Criteria.....	2-11
2-6	Anaerobic Digesters Design Criteria	2-12
4-1	Low-TDS Treatment Train Liquid Stream Quality based on 2008 Plant Data	4-1
4-2	High-TDS Treatment Train Liquid Stream Quality based on 2008 Plant Data	4-2
4-3	Primary Digester Feed and Digested Sludge Solids and Volatile Solids based on 2008 Plant Data.....	4-3

Figures

1-1	Laguna County Wastewater Reclamation Plant Location.....	1-1
2-1	Laguna County Wastewater Reclamation Plant Process Flow Diagram.....	2-2

Acronyms

°C	degrees Celsius
AACE	Association for the Advancement of Cost Estimating
ABF	Automatic Backwash Filter
ADWF	average dry weather flow
AWWF	average wet weather flow
B/C	benefit-to-cost
BFP	belt filter press
BOD	biochemical oxidation demand
C/I	commercial/industrial
CAS	conventional activated sludge
CCR	California Code of Regulations
CDPH	California Department of Public Health
CEC	Constituents of Emerging Concern
CHG	greenhouse gas
CLOMR	Conditional Letter of Map Revision
CMF	cloth media filtration
COD	chemical oxygen demand
DAFT	dissolved air flotation thickener
DBP	disinfection by-product
DBP	disinfection by-products
District	Laguna County Sanitation District
DO	dissolved oxygen
EC	electrical conductivity
FEMA	Federal Emergency Management Agency
FRP	fiberglass reinforced plastic
ft ²	square feet
ft ³ /lb	cubic foot per pound
FY	fiscal year
GBT	gravity belt thickener

gpd	gallons per day
gpm	gallons per minute
GSWC	Golden State Water Company
GWR	Ground Water Recharge
H ₂ S	hydrogen sulfide
hp	horsepower
HRT	hydraulic retention time
kWh	kilowatt hour
lb/d	pounds per day
LCC	life cycle cost
LCSD	Laguna County Sanitation District
LOMR	Letter of Map Revision
MBR	membrane bioreactor
MF	membrane filtration
MG	million gallons
mg/L	milligrams per liter
mgd	milligrams per day
MH	manhole
mJ/cm ²	millijoules per square centimeter
MLSS	mixed liquor suspended solids
MLSS	mixed liquor suspended solids
mm	millimeter
MPN	most probably number
N	Nitrate
NDMA	nitrosodimethylamine
NFIP	National Flood Insurance Program
ng/L	nanograms per liter
NPDES	National Pollutant Discharge Elimination System
NPV	net present value
NTU	nephelometric turbidity unit
NWRI	National Water Research Institute
O&M	operations and maintenance
OCP	Orcutt Community Plan

ORP	oxidation reduction potential
PF	peaking factor
psi	pounds per square inch
PVC	polyvinyl chloride
RAS	return activated sludge
RDT	rotary drum thickener
REC	Renewable Energy Credit
RO	reverse osmosis
rpm	revolution per minute
RPS	Renewable Portfolio Standards
RWDS	recycled water distribution system
RWQCB	Regional Water Quality Control Board
scfm	standard cubic feet per minute
SD	solar drier
SDB	sludge drying bed
SFHA	Special Flood Hazard Area
SMART	Simple Multi-Attribute Rating Technique
SPAD	single-phase anaerobic digestion
SRT	solids retention time
SSM	solids separation module
ST	sludge thickening
SWRCB	State Water Resources Control Board
TDH	total dynamic head
TDS	total dissolved solids
TF/SC	trickling filter/solids contact
TKN	total Kjeldahl nitrogen
TM	technical memorandum
TPD	two-phase digestion
TSS	total suspended solids
UF	ultrafiltration
USEPA	U.S. Environmental Protection Agency
UV	ultraviolet
UWMP	Urban Water Management Plan

VFD	variable frequency drive
VS	volatile solids
VSS	volatile suspended solids
WAS	wasted activated sludge
WDRs	Waste Discharge Requirements
WRTP	Wastewater Reclamation Treatment Plant
WWRP	wastewater reclamation plant

1.0 Introduction

1.1 Objectives

Laguna County Sanitation District (District or LCSD) is conducting a “Facilities and Financial Master Plan” for LCSD wastewater reclamation plant (WWRP). The purpose of the master plan is to provide a clear roadmap for design and implementation of the next expansion and upgrades to the reclamation plant. The master plan will be prepared by CH2M HILL.

The purpose of this technical memorandum (TM) is to present the results of the plant condition assessment, which can assist the District to improve, repair, replace, or decommission the structures or equipment as necessary.

1.2 Condition Assessment Criteria

The reclamation plant is located at the western terminus of Dutard Road off Black Road, on a 20-acre parcel (No.113-240-005) and a larger parcel (No. 113-290-013) in Santa Maria, California. Figure 1-1 shows the location of the plant.

FIGURE 1-1
Laguna County Wastewater Reclamation Plant Location

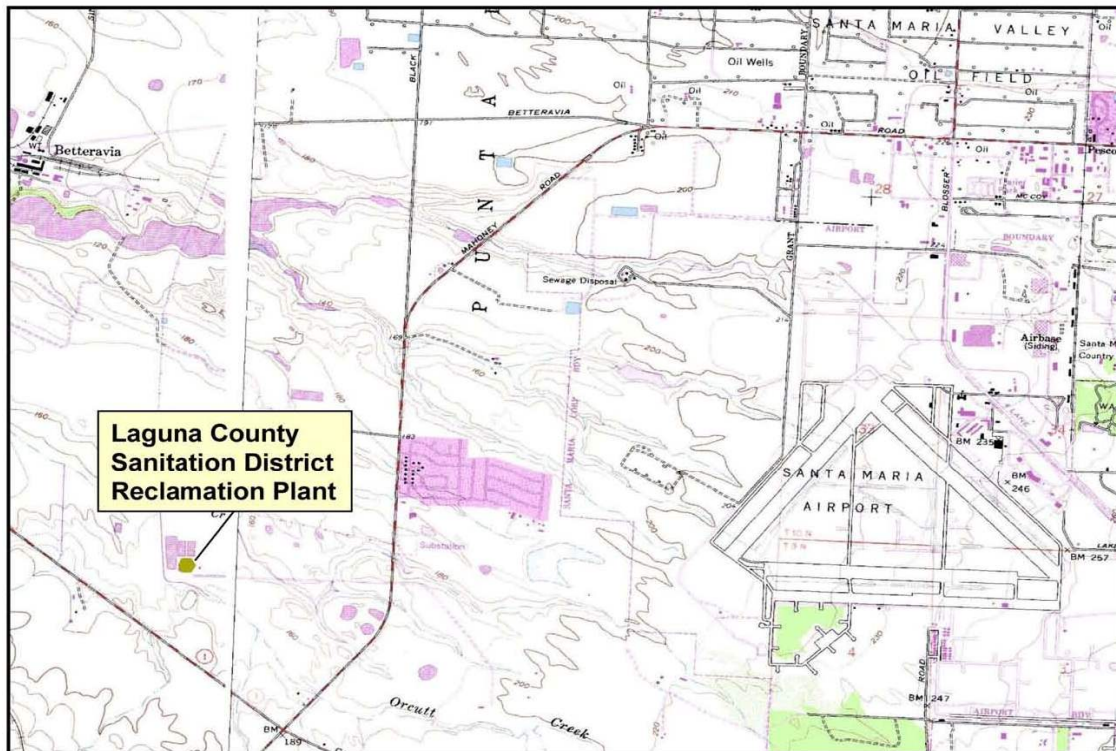

Base Map: USGS 7.5 Minute Quadratic Maps
Guadalupe (1982) and Santa Maria (1982)

FIGURE 1
Location Map
LCSD

The CH2M HILL team visited the plant in April and May 2009. The condition of the plant was assessed based on visual inspections of structures and equipment, generally during operation. Furthermore, the plant performance was assessed based on the water quality data of the main processes, including the influent, primary and secondary effluents, high total dissolved solids (TDS) influent and membrane bioreactor (MBR) effluent. The daily operation of the plant was also assessed based on health and safety considerations.

This TM is organized as follows:

Section 1 - Introduction

Section 2 - Description and Design Criteria of the Wastewater Reclamation Plant Facilities

Section 3 - Plant Condition Assessment Results

Section 4 - Processes Performance Evaluation

Section 5 - Conclusions

2.0 Description and Design Criteria of Wastewater Reclamation Plant Facilities

The LCSD WWRP is a 3.7-million gallon per day (mgd) facility that currently treats an average flow of 2.0 mgd. Wastewater flows enter into the facility headworks, which consists of screening and grit removal, before being directed to one of the two treatment trains – a high-TDS or a low-TDS train.

The low-TDS train, which has a capacity of 3.2 mgd, consists of a low-TDS flow equalization pond, two primary clarifiers, a trickling filter, a secondary clarifier, a flow equalization basin, and Zenon ZeeWeed® ultrafiltration units. The 0.5-mgd high-TDS train consists of a high-TDS flow equalization pond, a Zenon Zenogem® MBR, and a reverse osmosis (RO) unit with four membrane trains (three trains are currently in use). The treated flows from the high- and low-TDS treatment trains are combined before entering an ultraviolet (UV) disinfection system. The disinfected flow is stored in a recycled water pond before being pumped into the recycled water distribution system or stored in the recycled water upper storage reservoir during low demand periods. The process flow schematic of the plant is shown in Figure 2-1.

The plant is regulated by the Regional Water Quality Control Board (RWQCB) – Central Coast Region under Waste Discharge Requirements (WDRs) and Master Reclamation Permit Order 01-042.

The recycled water is pumped through a 1.7-mile purple polyvinyl chloride (PVC) pipeline for reuse to the Santa Maria Public Airport District, installed within Dutard Road right-of-way.

The sludge generated from the primary and secondary clarifiers is digested in anaerobic digesters and dewatered in sludge drying beds. The dewatered biosolids are hauled offsite, currently to Engel & Gray, Inc. composting facility in Santa Maria.

Concentrate (brine) from the RO system is pumped through a brine line to an injection well, located northwest of the plant and regulated by the U.S. Environmental Protection Agency (USEPA).

The following subsections provide a brief description of the main unit processes of the plant and their design criteria. The unit processes design criteria tables presented in the following sections were completed based on the available data.

FIGURE 2-1
Laguna County Wastewater Reclamation Plant Process Flow Diagram

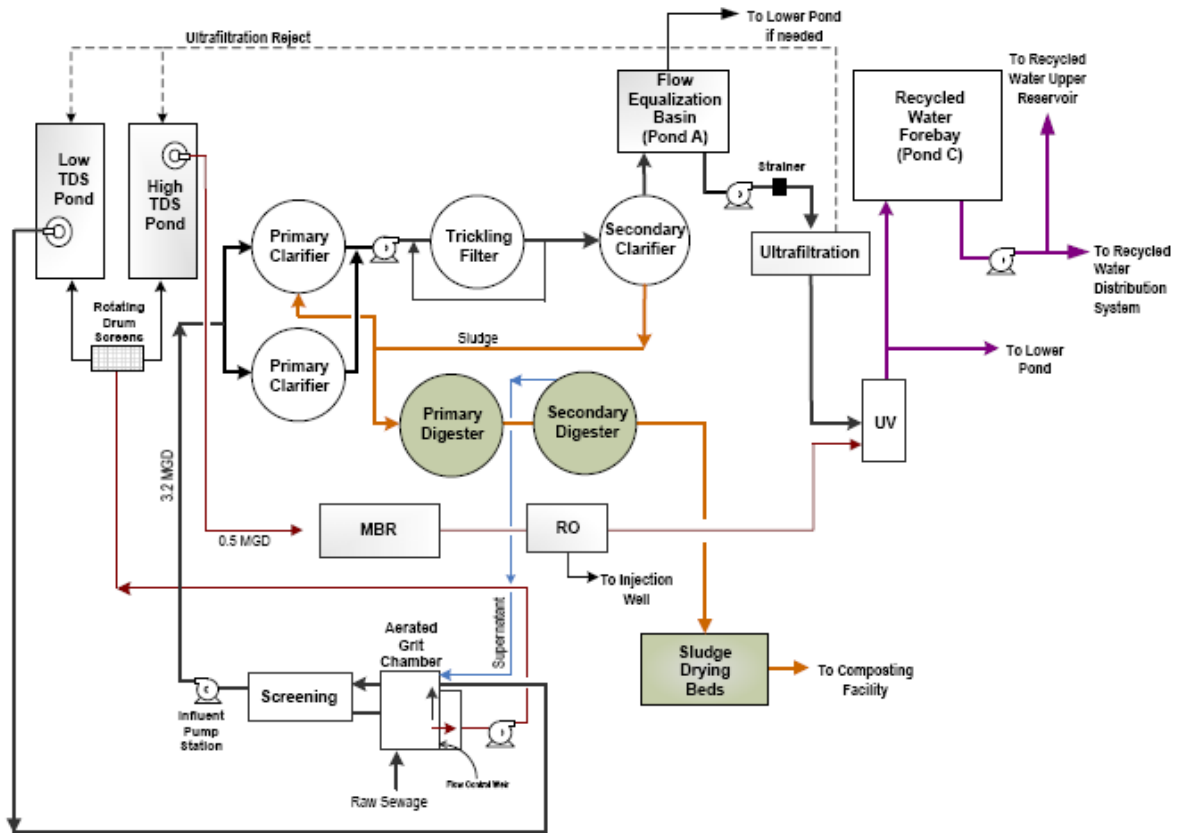

2.1 Headworks

The headworks is designed to handle peak flows of approximately 6 mgd. The headworks consisting of an aerated grit chamber, a step screen, and an influent pump station is briefly described below. Currently, raw sewage first enters the grit chamber and, depending upon electro-conductivity readings, the flow is conveyed to either high- or low-TDS treatment train. Under low electro-conductivity readings, the weir elevation at the end of the existing grit chamber decides if the flow needs to be conveyed to the low-TDS pond or conveyed to screening and then primary clarification. As high flow subsidizes, the stored flow in the low-TDS train is returned to the grit chamber, screened, and pumped to the primary clarifiers. As can be seen from the existing process flow diagram (Figure 2-1), the current flow management in headworks is complex.

The design criteria of the headworks are presented in Table 2-1.

TABLE 2-1
Headworks Design Criteria

Process / Equipment	Value
Headworks	
<u>Aerated Grit Chambers</u>	
Number of Chambers	1

TABLE 2-1
Headworks Design Criteria

Process / Equipment	Value
Type	Aerated
Length, ft	10
Width, ft	13
Side Water Depth, ft	7.7
Minimum Detention Time at Peak Flows, minutes	2.0
Air Supply, cfm/ft	8.30
<u>Step Screen</u>	
Number of Screens	1
Type	Huber Model SSV
Size	5300 x476 x6 at 70 degrees
Capacity, each, mgd	6
Opening, inch	1/8 (3 mm)
<u>Influent Pump Station</u>	
Number of Pumps	2 duty + 1 standby
Type	Centrifugal
Capacity, each, gpm	2,000
Capacity with One Standby Pump, gpm	4,000
TDH, each, ft	25

2.1.1 Aerated Grit Chamber

Wastewater is conveyed by gravity to the aerated grit chamber. The aerated grit chamber removes heavy inorganic material, such as sand, to protect the downstream mechanical equipment from abrasion. In addition, the grit chamber reduces deposition of sand and grit in the downstream basins, digesters, channels, and pipelines. Aerated grit chambers are typically designed to provide detention time of no less than 2 minutes under peak flow conditions (WEF MOP 8), which limits aerated grit chamber capacity at approximately 6 mgd.

A conductivity meter is provided at the grit chamber to measure the electrical conductivity (EC) of the incoming wastewater. This EC value is an indirect measurement of the TDS in the influent flow. The plant influent is split into low-TDS and high-TDS streams on certain times of the day during which a high-TDS flow to the plant is expected. Historically, the high-TDS flow reaches the plant between 5:00 a.m. and 10:00 a.m. during which the high-TDS flow is pumped to the "High-TDS Pond." Wastewater stored in the low-TDS pond is pumped to the downstream side of the weir in the aerated grit chamber to flow through the low-TDS train during the high-TDS bypass.

Screening

A recently installed step screen (Huber) is located in the low-TDS influent channel. The step screen removes solids, floatables, rags, and plastics to protect the downstream valves, pipes,

and fittings. Two manual screens, downstream of the step screen, are provided as a backup. These are used when the step screen is being repaired or cleaned.

Influent Pump Station

The influent pump station consists of three pumps (two duty + one standby), each with a capacity of 2,000 gallons per minute (gpm) at 25 feet total dynamic head (TDH). Two primary influent pumps have a combined capacity of 5.76 mgd.

2.2 Low TDS Liquid Treatment Train

The wastewater from the low-TDS pond is directed to the downstream side of the weir in the aerated grit chamber. The low-TDS pond is equipped with an aeration system that keeps the sewage from going septic and causing odor problems. The low-TDS treatment train includes the following:

- Low-TDS pond system
- Primary settling
- Secondary treatment, including a trickling filter and a secondary clarifier
- Secondary effluent equalization basin (Pond A)
- Tertiary treatment, including a membrane filtration system

The description of the low-TDS treatment train is presented below and the design criteria are shown in Table 2-2.

TABLE 2-2
Low-TDS Liquid Train Design Criteria

Process / Equipment	Value
Low-TDS Liquid Treatment	
<u>Low TDS Equalization Pond</u>	
Number of Basins	1
Volume, each, MG	2
Basin Depth, ft	8
<u>Low TDS Pond Pump Station</u>	
Number of Pumps	2
Type	Submerged
Capacity, each, gpm	1,050
TDH, each, ft	23
HP, each	10
Speed, rpm	1,700
<u>Low TDS Pond Aeration System</u>	
Number of blowers	3
Airflow, scfm	2,000
Available Pressure at Top of Dropleg	5
Mixing Rate, scfm/1,000 cf	15
Primary Clarification	
<u>Primary Clarifiers</u>	
Number of Primary Clarifiers	2

TABLE 2-2
Low-TDS Liquid Train Design Criteria

Process / Equipment	Value
Diameter, each, ft	65
Side Water Depth, each, ft	7.5
Overflow Rate w/o Recycle, gal/day/sf	482
Overflow Rate w/100% Recycle, gal/day/sf	874
Detention Time at ADWF, hr	2.79
Detention Time at PWWF, hr	1.54
Weir Overflow Rate at ADWF, gal/day/sf	7,835
Primary Sludge/Scum Pumps	
Number of Sludge/Scum Pumps (one per clarifier)	2
Capacity per Pump, gpm	75
Average Sludge Concentration, %	4.0
Average Sludge Flow, gpd	14,000
Trickling Filters	
Number of Units	1
Diameter, ft	150
Media Type	Rock
Media Depth, ft	3
Media Volume, cf	53,000
Number of Feed Pumps	(1 duty +1 standby)
Capacity per Pump, gpm	4,031
Feed Rate, mgd	5.80
Hydraulic Loading without Re-circulation, gal/day/sf	181
Hydraulic Loading with Re-circulation, gal/day/sf	328
BOD Loading without Re-Circulation, lb/cf/d	62.2
BOD Loading with Re-Circulation, lb/cf/d	78.5
Secondary Clarification	
Secondary Clarifiers	
Number of Units	1
Diameter, ft	90
Side Water Depth, ft	11
Detention Time at ADWF, hrs	3.93
Detention Time at PWWF, hrs	2.17
Weir Overflow Rate at ADWF, gal/day/sf	11,300
Storage Ponds A (Flow Equalization)	
Volume, each, MG	9.22
Depth, ft	8
Tertiary Treatment	
Ultrafiltration Membrane System	
Average Daily Flow, mgd	3.56
Average Production Capacity, mgd	3.2
Nominal System Recovery, %	90
Strainer Opening, mm	1

TABLE 2-2
Low-TDS Liquid Train Design Criteria

Process / Equipment	Value
Number of Trains (Tanks)	2
Maximum Day Feed Flow of Each Train, mgd	3.56
Membrane Module Type	ZeeWeed 500C
Nominal Pore Size of Hollow Fiber Membranes, micron	0.04
Number of Cassettes per Train	14
Number of Membrane Elements per Cassette	26
Total Number of Membrane Elements	728

Notes:

ADWF: Average Dry Weather Flow

PWWF: Peak Wet Weather Flow

2.2.1 Low TDS Pond

The low-TDS pond system includes a pond, a pump station, and an aeration system. The purpose of the pond is to stabilize the organic matter and to provide flow equalization. Generally, the pond holds the low-TDS wastewater and the waste flow from the ultrafiltration units. Capacity and components of the existing low TDS pond is presented in Table 2-2.

2.2.2 Primary Treatment

Primary settling is a physical separation process during which floatable and settleable materials are removed from the wastewater by sedimentation. The two circular primary clarifiers receive wastewater from the low-TDS pond. Scum is collected from the liquid surface by skimmers and discharged to the digesters. Settled materials (biosolids) are removed from the clarifiers and pumped into the digesters. The clarified wastewater flows over the effluent weirs and enters the trickling filter influent pump station by gravity.

2.2.3 Secondary Treatment

Secondary treatment at WWRP is provided by a rock media trickling filter and a secondary clarifier.

The rock media trickling filter at WWRP was designed to achieve biological oxygen demand (BOD) removal. The primary effluent is sprayed over the surface of the trickling filter via distribution arms. The treatment of wastewater by biological filter is carried out by complex communities of microorganisms, including bacteria; protozoa; metazoa (i.e., rotifers); fungi; and algae, which constitute the biofilm. The trickling filter is termed a “fixed” or “attached” growth system because the biofilm growth occurs on the surface of an inert medium (i.e., rock surface). The medium provides a high specific surface area so that biological oxidation of pollutants and oxygen transfer can proceed at optimal rates. A portion of effluent is recirculated to increase contact time between the wastewater and the biofilm, thus increasing BOD removal performance. Recirculation improves distribution over the surface of the filter, reduces the tendency to clog, and helps control filter flies. The typical BOD removal efficiencies are between 40 and 85 percent for trickling filters.

The flow from the trickling filter enters a secondary clarifier via gravity. The purpose of secondary clarification is to provide solids liquid separation, generally the sloughed-off biofilm material from the trickling filter. The design criteria of the secondary clarifier are presented in Table 2-2. Neither the trickling filter nor the secondary clarifier has redundancy; hence, if either of the units were out of service for maintenance, a serious secondary treatment bottleneck would occur.

Secondary Effluent Equalization Basin (Storage Pond A)

The flow equalization basin between the secondary clarifier and the ZeeWeed® Membrane Filtration System dampens diurnal flows and ensures steady flow to the membrane filtration system. The flow equalization basin is 8 feet deep and has a capacity of 9.22 million gallons (MG).

2.2.4 Tertiary Treatment

Tertiary treatment consists of two processes – filtration and disinfection. The filtration unit process is described in this section, but the disinfection process is described in Section 2.4 under UV Disinfection.

Filtration is achieved using a membrane system that consists of Zenon ZeeWeed® hollow-fiber ultrafiltration (UF) membranes. Membrane filtration effectively removes particulate material (i.e., turbidity, suspended solids, and bacteria), and the particulate fraction of organic and colloidal material. Viruses are also removed but to a lesser extent. The complete list of the UF system design criteria can be obtained from the Zenon ZeeWeed® system operations and maintenance (O&M) manual.

2.3 High TDS Treatment Train

The high-TDS treatment process has a treatment capacity of 0.5 mgd and includes the following:

- Fine screening
- Membrane bioreactor (Zenon Zenogem)
- Reverse osmosis

A brief description of the high-TDS treatment train is given below, and the design criteria are presented in Table 2-3.

2.3.1 Fine/ Rotating Drum Screen

The rotating drum screen (one duty + one standby) with 1-millimeter (mm) openings removes suspended solids larger than 1 mm from the water. The rotating drum screen consists of an internally fed rotary drum with an internal screw for transporting screenings out of the drum. Accumulated debris is continually removed from the screen by the rotation of the drum and is deposited into the compactor/grinder. A compactor/grinder further chops the debris before being disposed into the dumpster. Grit and screenings from headworks are collected and ultimately disposed in a landfill.

TABLE 2-3
High-TDS Liquid Train Design Criteria

Process / Equipment	Value
High-TDS Liquid Treatment	
<u>Rotating Drum Screen</u>	
Number of Screens	2
Average Opening in Each Direction, mm	1
Type	ROTO-GUARD MODEL 2500
<u>High TDS Pond</u>	
Number of Basins	1
Volume, each, MG	1
Basin Depth, ft	8
<u>High TDS Pond Pump Station</u>	
Number of Pumps	2
Type	Submerged
Capacity, each, gpm	350
TDH, each, ft	46
HP, each	10
Speed, rpm	1,700
<u>High TDS Pond Aeration System</u>	
Number of Blowers	1
Airflow, scfm	4,000
Available Pressure at Top of Dropleg	5
Mixing Rate, scfm/1,000 cf	15
Membrane Bioreactor (MBR)	
Average Daily Flow, mgd	0.5
Peak Hourly Flow, mgd	0.5 (Flow equalization is provided)
Number of Trains (Tanks)	2
Capacity of Each Train, mgd	0.25
Membrane Module Type	ZeeWeed ZW-500B
Number of Cassettes per Train	4
Number of Membrane Modules per Cassette	8
Total Number of Membrane Modules	64
Number of Process Tanks	2
Tank Volume, each, gallons	46,875
<i>Tank Dimensions</i>	
Length, ft	50
Width, ft	12
Height, ft	12
Side Water Depth, ft	10.5
<u>Process Air Blowers</u>	
Type	Positive Displacement

TABLE 2-3
High-TDS Liquid Train Design Criteria

Process / Equipment	Value
Total Number of Blowers	2 (1 Duty+1 standby)
Capacity of Each Blowers, scfm	600
<u>Air Scour System</u>	
Type	Positive Displacement
Number of Blowers	2
Capacity of Each Blowers, scfm	600
<u>Permeate Pumps</u>	
Number of Pumps	3 (2 Duty+1 standby)
Pump Capacity, each	174 gpm @ 50 ft TDH (permeate) 294 gpm @ 30 ft TDH (back pulse)
<u>Sodium Hypochlorite Feed System</u>	
Number of Feed Pumps	2 (1 duty +1 standby)
Capacity, each, gph	0.77
Type	Diaphragm
Number of Sodium Hypochlorite Storage Tanks	1
Capacity, gallons	26
Number of Days Storage, days	20

2.3.2 High TDS Pond

The high-TDS pond system includes a pond, a pump station, and an aeration system. The purpose of the pond is the dampening of wastewater flow variations and stabilization of the organic matter by reducing or eliminating shock loading.

2.3.3 Membrane Bioreactor

The MBR is a Zenon ZenoGem, which integrates biological treatment with an integrated membrane system to provide enhanced organics stabilization (effluent BOD less than 5 milligrams per liter [mg/L]) and suspended solids removal (i.e., effluent total suspended solids [TSS] less than 1 mg/L). With the membrane units forming a “barrier” for separation of solids and liquids, MBR systems are designed to operate at mixed-liquor suspended solids (MLSS) concentrations as high as 12,000 mg/L, resulting in a much smaller aeration tank volume requirement compared to conventional activated sludge systems. The MBR support facilities include permeate pumps, a chemical storage system, an air scour system, and a back-pulse water flushing system. The air scour system consists of coarse bubble diffusers located in the membrane tank and provides continuous or intermittent agitation outside the membranes to minimize solids deposition.

2.3.4 Reverse Osmosis

As part of the tertiary treatment, the RO process removes TDS, dissolved organic and inorganic material, as well as pathogenic microorganisms from the high-TDS flow. The

design criteria for the RO system can be obtained from the RO membrane system O&M manual.

A roughly 6-mile-long pressurized pipeline is used to dispose of RO concentrate via deep well injection. The RO concentrate is injected to Union Sugar Well No. 13, which originally was an oil-producing well that has been converted to a Class 1 nonhazardous injection well.

2.4 UV Disinfection

The effluent from the low- and high-TDS treatment trains is combined and disinfected through a UV disinfection system before being discharged to the recycled water storage pond. The UV disinfection at WWRP is a closed system, medium-pressure Aquionics UV system containing four banks. Design criteria of the UV system are presented in Table 2-4.

TABLE 2-4
UV Disinfection System Design Criteria

Process / Equipment	Value
UV Disinfection	
Validated Capacity, mgd	3.7
Maximum Inlet TSS Concentration, mg/L	5.0
Maximum Inlet Turbidity, NTU	2.0
Minimum UV Transmittance at 254 nm, %	65
Maximum Iron Concentration, mg/L	0.3
UV Reactor Type	Closed Vessel
UV Lamp Type	Medium Pressure
UV Model Name	Aquionics Model 7500
Minimum UV Dose Requirement, mJ/cm ²	80 (Per NWRI guidelines)
Minimum Operating UV Dose, mJ/cm ²	200 (Per CDPH Permit)
Total Number of Banks	4
Number of Duty Banks	1

mJ/cm²: Millijoules per square centimeter

2.5 Recycled Water

2.5.1 Recycled Water Pond

Following UV disinfection, tertiary effluent flows by gravity to an uncovered onsite holding pond (Pond C). Pond C is directly adjacent to a series of sludge drying beds and is approximately 100 feet from one of the primary clarifiers. The holding pond has approximately 1 MG of storage capacity; however, only 500,000 gallons is useable capacity due to the elevation of the suction pipe to the tertiary effluent pump station.

During times of recycled water demand, an 18-inch suction pipeline draws water from the recycled water holding pond, and the effluent pump station conveys recycled water to customers. When demand for recycled water declines and the holding pond becomes full, flow is diverted to an unlined 300-MG tertiary effluent reservoir approximately 1.5 miles north of the treatment plant site. Water from the reservoir is used to irrigate neighboring pastureland and for use by an oil company for steam injection.

In the event that the effluent receives inadequate UV dose (i.e., less than 200 millijoules per square centimeter [mJ/cm²]) for Title 22 tertiary effluent, or if the tertiary and or disinfection system are offline, undisinfected effluent bypasses the recycled water holding pond and is diverted to a series of secondary holding ponds. This effluent, which is considered undisinfected secondary effluent, is permitted by the RWQCB to be used for the irrigation of pastureland in areas adjacent to the WWRP.

2.5.2 Recycled Water Pump Station

Three recycled water pumps, each with 1,620-gpm capacity, are used to convey the recycled water. The design criteria of the recycled water pond and the recycled water pump station are presented in Table 2-5.

TABLE 2-5
Recycle Water Pond and Pump Station Design Criteria

Process / Equipment	Value
Recycle Water Pond (Pond C)	
Working Volume, MG	0.5
Recycle Water Pump Station	
Number of Pumps	3
Type	Centrifugal
Drive	VFD
Capacity, Each, gpm	1,620
TDH, each, ft	240
HP, each	125
Speed, rpm	1,790

2.6 Solids Treatment

The sludge from primary and secondary clarifiers is stabilized in an anaerobic digester, settled in a secondary (unheated, unmixed) anaerobic digester, and dewatered in sludge drying beds. The digested and dewatered biosolids are hauled offsite and ultimately composted and recycled as a soil amendment.

2.6.1 Anaerobic Digesters

The WWRP has two digesters. Primary and secondary sludges are pumped to the primary digester, which is heated to destroy pathogens and stabilize the wastewater solids. The

digested solids are then pumped to a secondary digester where solids are settled and further concentrated in an unheated and unmixed environment. The digested solids are dewatered using sludge drying beds. The design criteria of the anaerobic digesters are shown in Table 2-6. The biogas produced in the digesters is collected, cleaned, and burned in the boiler to generate hot water. The biogas cleaning system consists of a newly installed iron sponge unit and a siloxane removal system downstream of the iron sponge. Ferric chloride is used in the iron sponge unit to reduce hydrogen sulfide (H₂S) in the biogas to below 35 mg/L.

TABLE 2-6
Anaerobic Digesters Design Criteria

Process / Equipment	Value
Solids Treatment	
<u>Primary Digester</u>	
Number of Digesters	1
Operating Temperature, °F	96
Diameter, ft	39
Side Water Depth, ft	23.5
Operating Volume, cf	28,100
Hydraulic Retention Time, days	15
Type of Mixing	Gas
Gas Mixing Capacity, cfm	62
<u>Secondary Digester</u>	
Number of Digesters	1
Diameter, ft	55
Side Water Depth, ft	23.5
Operating Volume, cf	55,800
Hydraulic Retention Time, days	30

3.0 Plant Condition Assessment Results

3.1 Introduction

The CH2M HILL team, consisting of mechanical, structural, material, and electrical engineers, conducted a qualitative assessment of the reclamation plant in April and May 2009. The field observations data log from each discipline is presented in Appendix A. The qualitative assessment was primarily based on visual observations, which were documented by photographs taken during the site visits. Appendix B presents the photographs (B-1 through B-49) demonstrating the condition of the equipment and structures. Appendix C presents the photographs (C-1 through C-17) of the electrical equipment and systems.

Physical condition of equipment was assessed based on the general appearance, wear, and tear, as well as corrosion. Equipment functionality was assessed based on the operational reliability and the ability of the equipment to accomplish their purpose. Structures were evaluated based on structural and material integrity. Input from the plant operations staff was taken into consideration in the assessment process. The health and safety measures of the plant were also assessed. Condition assessment results are presented in the following subsections.

3.2 Headworks

Although it is well maintained, the existing headworks facility including electrical system has already approached its useful life, thereby requiring replacement in near future (Photos C-1 through C-9).

Vault

The wastewater flow enters the plant headworks through two transmission pipelines. The combined flow is directed to the aerated grit chamber. The concrete in the vault is in good condition without exposed aggregate (Photo B-1). The iron gates are rusty but without significant corrosion (Photo B-1).

Aerated Grit Chamber

The concrete is in good condition with minor surface defects. The wetted surfaces are lined with an epoxy, which is generally in good condition and seems to be able to protect the concrete surfaces. Few small damaged areas with exposed aggregate were observed above the water line (Photo B-3).

Grit Removal Equipment

The grit removal equipment is relatively new and constructed of stainless steel (Photo B-4) without any sign of corrosion. The grit screw conveyor is functional without any reported problems. The transfer pumps transferring the high-TDS flow to the high-TDS pond are well maintained and functional. The inspection was limited to the external and above-water level parts of the equipment. The submerged portions of the transfer pumps and piping are

coated, and the coating seems to be intact without a significant damage. The surface of the pumps and piping shows some corrosion (Photo B-5).

Associated Structures

Handrails, grating, and supports are constructed of a mixture of anodized aluminum, painted steel, stainless steel, and painted galvanized steel. Stairways and handrails are in fair condition with some corrosion on the handrails (Photo B2 and B4). The paint is flaking off the painted components, with no significant corrosion. In some areas, the guardrails are constructed in a two-rail guardrail transitioned to a three-rail (Photo B-6). Ideally, the level of protection in a structure is expected to be the same.

Screening

The entire concrete channel is lined. The lining prior to screening is not able to bridge the bug holes and voids in the concrete surface (Photo B-7). The channel after the screening has a thicker lining with no obvious holidays or voids. In general, the concrete appears to be in good and nearly new condition. The metals are in good condition with no significant corrosion damage (Photo B-9).

A step screen used on the low-TDS water is constructed of stainless steel. The screen and the wash press have been in operation since 2008. According to the plant staff, the safety chain on the railing is loose and comes off (Photo B-8).

Associated Structures

The handrails, grating, and supports are constructed from a combination of plastic, stainless steel, aluminum, painted steel, and galvanized steel. The plastic appears to be in good condition. The stainless and galvanized steel show minor corrosion staining. The aluminum parts are not corroded. Minor defects, such as a spall at the guardrail post base (Photo B-10) and exposed rusting embedded metal and rebar, were observed in this area. Some areas, such as corroded steel steps (Photo B-11) and fiberglass opening covers (Photo B-12), appear to be unsafe.

Condition Summary and Recommendations

With the exception of the step screen (installed in 2008), the existing headworks facility is old and generally in fair structural condition. Some areas such as access steps and fiberglass roof covers need to be replaced to meet current safety standards. The electrical system, including the existing service entrance equipment, is very old; and replacement might not be feasible. In addition, the electrical system has no redundancy. It is recommended that LCSD consider building a new headworks facility in near future.

3.3 Low TDS Liquid Treatment Train

The electrical system in the low-TDS treatment train is the original electrical system from 1959 but is well maintained (Photos C-10 through C-15).

Low-TDS Pond

The concrete surfaces of the low-TDS pond pumping vault are in good condition (Photo B-13). The coated pumps appear to be in good condition. The coated steel supports associated with the pump guides are in fair condition. In some areas, however, the coating is

missing; and corrosion has started to occur. The stainless-steel guides and sidewalk doors are also in good condition.

The aeration system is equipped with three blowers. The dedicated blowers look good, well maintained, and operational. There is a standby unit common for both low- and high-TDS ponds. The low TDS pond was recently lined, and no upgrade is needed in near future. The pond has enough capacity to provide flow equalization in the future as well. The flow equalization can significantly reduce the size of the secondary treatment facilities and offer flexibility to treat plant flows overnight when electricity rates are typically much lower than the day time rates.

Primary Treatment

Influent Pump Station

The exterior of the pumps and valves is significantly corroded (Photo B-14). According to the plant operators, some of the valves are corroded open and some are operable. Corrosion in the internal parts is so advanced that water can pass through even when the valves are in the "Closed" position. The District is planning repairs in fiscal year 2009/2010. However, these repairs may not be worthy especially considering the age and condition of the existing facility. Therefore, building a new influent pump station as part of the headworks upgrade is recommended.

Primary Clarifiers

The concrete surface in the primary clarifiers is not lined, and slightly exposed aggregate was observed in some areas. The worst damage is below the water line; however, the concrete surface above and at the water line looks alright (may require more detailed evaluation to determine the condition of the concrete structure).

The existing clarifier drives, bridges, influent risers, and scraper mechanisms (scum beach and surface skimmer) in both primary clarifiers appear to be old and significantly corroded (Photo B-15). Corrosion perforations in the scum beach reportedly are frequently observed and repaired. The launder surface is rough with minor defect (Photo B-16). At the time of the site visit, the clarified water flowing over the weir to the effluent launder looked clean, although traces of fines were observed near the scum collector. In addition, the center column in the primary clarifier closer to the shop building is probably not firmly attached to the floor. The bolts were recently inspected but not replaced.

Primary Clarifier Outlet Box

The primary clarifier outlet box is constructed of concrete and includes several pipe penetrations. The concrete is lined, but the lining is damaged in several areas (Photo B-17). In general, the concrete appears to be in fair condition. The pipe penetrations have been coated after significant corrosion and metal loss. It appears that the coating has prevented further corrosion of the pipe penetrations.

Primary Clarifier Sludge/ Scum Pumps

The existing solids pump at each clarifier handles both sludge and scum. Different types of pumps are used for each primary clarifier. Exterior parts of all of the pumps and piping are in good condition with minimal areas of coating damage or corrosion staining (Photo B-18). The interior condition of the pumps, piping, and valves are unknown. Generally, the equipment is old but well maintained and functional.

Associated Structures

The handrails and walkway supports are constructed of painted steel. The steel shows minor corrosion. Large areas of damaged coating are present over the entire structure.

LCSD should either replace existing clarifier drives, bridges, influent risers, and baffles and scraper mechanisms or build two new primary clarifiers (75 feet in diameter, each) and abandoned the existing primary clarifiers. Building new clarifiers will make flow management easy and enhance clarification performance while treating future flows with one unit out of service.

Secondary Treatment

Trickling Filter

The concrete surface is in fair condition with no signs of exposed aggregate. The trickling filter structure has, however, several obvious vertical and repaired cracks. It appears that the cracks have penetrated through the concrete wall (Photo B-19). Vertical shrinkage was also observed (Photo B-20). The operators reported that water frequently leaks through these cracks. The amount of cracking is unknown.

The water distribution mechanism has obvious signs of corrosion (Photo B-21). Both the rotary distribution and flow distribution arms were replaced in 2004. The flow distribution arms look aged but well maintained. The severity of the corrosion cannot be assessed while the unit is in operation. The rock media is the original media from 1959.

The trickling filter is old and has serious structural concerns due to the apparent cracks. This facility needs to be abandoned in the initial phase of the plant upgrade.

Feed/ Recirculation Pumps

There are two feed/recirculation pumps designated to the trickling filter, one duty and one standby. The pumps are old but well maintained. At the time of the site visit, there was a sign stating "Do Not Operate" on the second pump. It was reported that the pump had not been in operation for some time.

Secondary Clarifier

The secondary clarifier is in the similar condition as the primary clarifiers and with the same operational and maintenance issues. Due to corrosion, the baffle adjacent to the weir is perforated below the waterline.

The mechanism in the secondary clarifier, which is newer than those in the primary clarifiers, appears to be in good condition – well maintained and operational. The aluminum deflectors on the wall and fiberglass reinforced plastic (FRP) center baffle will be replaced in 2009. The FRP will be replaced with stainless steel.

At the time of the site visit, the clarified water over the weir looked clear, although with traces of fines near the scum beach.

If the process selection favors a conventional activated sludge system for the future plant upgrade, the existing clarifier may be used in the future.

Associated Structures

The perimeter handrails are constructed of anodized aluminum and are in good condition. The hose bibs and hose racks are constructed of galvanized steel. The galvanizing is corroding, but the underlying steel seems fine (Photo B-22).

Secondary Clarifier Sludge Pump and Scum Pump

Both the sludge pump and the scum pump are in good condition – well maintained and operational.

Storage Pond A

Pond A was dredged in 2008. It was reported that soil gets pulled in with the water feeding the ZeeWeed membrane filtration system. A 1-mm strainer was recently installed ahead of the membrane filtration system to prevent potential damage to the membranes. The small structures and electrical boxes located around the pond are not safely secured (Photos B-24, B-25, B-26, and B-27). The structure near the pond (Photo B-27) was installed in 1959 and originally served as a flow control structure for the secondary effluent to Pond A and the low-TDS pond.

Pond A currently provides flow equalization prior to ultrafiltration. The flow equalization may not be needed in the future after the future secondary treatment. However, Pond A can serve emergency flow storage under wet weather conditions.

Tertiary Treatment

Ultrafiltration Pump Station

The pump station is constructed of lined concrete. The concrete and lining appear to be in good condition without any lining or concrete damage (Photo B-28). The gates located under an overhang are in fair condition with no obvious corrosion issues. The pumps, aboveground piping, and valves are constructed of coated steel and coated ductile iron. The coating is damaged in several locations (Photo B-29), and significant corrosion but minor metal loss has occurred in the same areas.

Strainers

The metallic 1-mm strainer with coated interior is in good condition.

Ultrafiltration Membrane System

The membrane filtration system consists of the ultrafiltration structure, a chemical feed system storage area, an electrical area, and an FRP cleaning tank.

The membrane filtration system was in operation during the site visit; therefore, the interior of the ultrafiltration structure could not be inspected. The nonmetallic items in this area are in good condition. Compressed air storage tanks have internal corrosion that could be due to chemical fumes originating from the adjacent chemical storage tanks.

The chemical feed system and the electrical system are housed beneath a canopy, directly adjacent to the ultrafiltration structure. The canopy (Photo B-30) appears to be lightly framed and lacks wind/seismic bracing on the front and is minimal on the sides.

The conduit supports, unistruts, electrical boxes, electrical enclosures, and structural steel are constructed of coated steel. The coating on the components closest to the sodium hypochlorite tank and the ultrafiltration structure are significantly damaged. Significant

corrosion staining has occurred in the damaged coating; however, the corrosion appears to be mostly cosmetic in nature (Photo B-31).

The FRP cleaning tank was reported to be leaking (Photo B-32). According to the plant operators, the bottom of the tank is cracked because of the alternating pressures associated with the filling and draining the tank. During the daily membrane cleaning, a strong smell of sodium hypochlorite reportedly overpowers the area surrounding the ultrafiltration structure.

The Zeeweed membrane system is relatively new. To date, 310 membrane modules were replaced. LCSD is planning to replace all remaining 418 membrane elements by 2012.

The major concern with the existing Zeeweed ultrafiltration system is that the plant staff has indicated that the existing system requires frequent repair and maintenance exceeding the originally anticipated routine repair and maintenance needs. These needs mainly include frequent repair of the failed membrane fibers and repair of malfunctioning valves and actuators. The plant staff also indicated that the ultrafiltration trains are producing much lower filtrate flows than their projected capacities. This indicates that the capacity of the existing ultrafiltration system is actually lower than 3.2 mgd, which can only handle the current flows. Therefore, the existing ultrafiltration system will be replaced under the initial phase (Phase I) upgrades.

3.4 High TDS Liquid Treatment

The electrical system and equipment in the high-TDS liquid treatment train needs to be frequently maintained (Photos C-16 and C-17).

High TDS Pond

The pond is equipped with a concrete pumping vault. The concrete of the vault was in good condition with no exposed aggregate. The coated pumps are in good condition. The stainless-steel guides and sidewalk doors are also in good condition. The coated steel supports associated with the pump guides, however, are in poor condition. The coating is, for the most part, nonexistent; and corrosion with minor metal loss has started to occur (Photo B-33).

The high-TDS pond was recently lined, and no upgrade is needed in near future. The pond has enough capacity to provide flow equalization for high-TDS flows in the future as well. The flow equalization can significantly reduce the size of the future MBR expansion and offer flexibility to treat plant flows overnight when electricity rates are typically much lower than the daytime rates.

High-TDS Screening

The high-TDS screening consists of two sets of rotating drum screens. The second set of screens was installed recently. The new set is the same as the original set. The screens are stainless steel each with 1-mm opening. They look well maintained and operate well. The screening mechanisms appear to be in good condition. The original screen set has some corrosion staining but mainly cosmetic in nature (Photo B-34).

Supporting Structures

The walkway and walkway supports surrounding the screens are constructed of coated steel. The walkway around the newer screen is in good condition with no coating damage or corrosion. Multiple small areas with damaged coating were observed in the walkway around the original screen. At areas of coating damage, significant corrosion and metal loss was also observed (Photo B-35). Because of the infrequency of the coating damage, the walkway is generally in fair condition.

Membrane Bioreactor

The membrane structure consists of steel tanks with a plastic grating overtop and painted steel handrails. Apart from the coating damage and slight corrosion at the base (Photo B-36), the tanks are generally in good condition. It was reported that the process drains and walkway drains are interconnected. Consequently, the drains backup and the process water, including the waste from membrane cleaning, accumulates near the base of the steel tanks. Hence, the coatings of the base and the nearby buildings are damaged and corroded. The corrosion and minor cracks in the steel tank between the first and second membrane structures seem to be due to poor drainage (Photo B-37). The coated-steel handrails are generally in good condition with only minor coating damage and corrosion staining. The membrane elements fail due to fiber breakage and need to be repaired often. One of the permeate pumps (the one in the middle) has a fine layer of rust.

Membrane Bioreactor Feed Pumps

The team was not able to inspect the two feed pumps, but no problems associated with the feed pumps were reported.

Membrane Bioreactor Aeration System

The dedicated blower is well maintained and operating well. However, significant coating damage and corrosion were observed in small isolated areas on the blower exhaust (Photo B-38). The cause of this corrosion is unknown. The intake filters are rusty. The grills on the air conditioning units also have some rust.

Return Activated Sludge Pumps

No problem associated with the two return activated sludge (RAS) pumps was reported.

Waste Activated Sludge Valve

No problem associated with the two waste activated sludge (WAS) valves was reported.

Electrical/Control Building

There is a significant amount of blown dust and particles in the Electrical/ Control Building, which seems to specifically affect the filters on all equipment (Photo C-17).

Chemical Building

The chemical feed system, storage area, and electrical boxes are enclosed in a coated-steel building. The chemical feed system and storage area include plastic piping, metallic water pumps, coated steel unistruts, and pipe supports. The nonmetallic items are in good condition. No obvious signs of degradation were observed, and no issues were reported.

The coated-steel shows corrosion staining over the majority of the surfaces. The floors and supports attached to the floor are significantly corroded with minor metal loss (Photo B-39).

The drains can back up and cause ponding within the building, therefore accelerating corrosion of the floor.

Washers and fasteners seem to be constructed of uncoated steel. The uncoated components are corroding over the entire surface, and metal loss has begun to occur (Photo B-40).

General Chemical Area

The main chemical storage area consists of holding tanks, metering pumps, and a roof structure. The majority of the facility is in good condition. The coated-steel tank anchor elbows show coating damage and corrosion staining (Photo B-41). No metal loss is observed as of yet.

Reverse Osmosis

The RO units appear to be in good condition. The stainless-steel piping and coated-steel support structure are in good condition, as is the prefabricated building. The stainless-steel piping shows corrosion staining in some areas; however, the staining is cosmetic in nature (Photo B-42). The condition inside the stainless-steel piping is unknown.

Condition Summary

The high-TDS liquid treatment train seems to be in good condition. The main concern in this area is membranes failure due to fiber breakage and the need for frequent repair. Generally, the metallic components are corroded, but the corrosion is not significant yet. The drainage problem should be addressed, and the steel tank between the two membrane structures should be inspected and repaired before the corrosion advances more. The plastic grating is in good condition. To maintain the blower in the membrane bioreactor system, it is recommended that its inlet filters be inspected and cleaned regularly. To avoid unexpected shutdowns, the equipment maintenance and filter cleaning could be scheduled every 6 months in the Electrical/Control Building.

3.5 Disinfection

The UV disinfection consists of UV lights in line with abovegrade piping. The exterior of the piping and UV units is in good condition. The condition inside the piping and UV units is unknown.

3.6 Recycled Water

Recycled Water Pond

The final storage for the recycled water is a soil pond (Photo B-43). The District is now replacing the pond with a 1-MG, 75-foot-diameter, abovegrade, welded-steel storage tank to minimize deterioration in the final effluent quality due to wind-blown dust and debris, algae blooms, and bird and rodent impacts. LCSD is planning to add three 1-MG storage tanks in the future.

Recycled Water Pump Station

The effluent pumps and piping are constructed of coated steel. The exteriors of the piping and pumps are in good condition with only small areas of coating damage and corrosion

staining (Photo B-44). No issues were reported on the pump operations; however, the condition inside the piping and pumps is unknown.

3.7 Solids Treatment

Digesters

The primary digester has a mixing feature and consists of a concrete tank with a welded-steel fixed cover with a water seal. The steel cover of the primary digester is leaking due to material loss after blasting during the last coating repair. It was reported that the welded-steel cover and the water seal are severely corroded and that plans for replacement are underway. The primary digester influent and overflow boxes are constructed of lined concrete. The concrete is slightly damaged. The condition of the interior of the concrete tank walls is unknown. The outside surface of all exposed biogas piping looks acceptable. The biogas mixing compressor looks well maintained and operational. LCSD is currently replacing the primary digester steel cover with a concrete cover.

The secondary digester has no heating and mixing features and is referred to as a sludge holding tank, which consists of a concrete tank with a concrete cover and a water seal. Minor cracks were observed in the concrete roof (Photos B-45 and B-46) during the site visit. However, no problem associated with leakage through the concrete cover was reported. It was, however, reported that repairs are required for the water seal due to severe corrosion. The secondary digester lined-concrete boxes show signs of exposed aggregate prior to the lining. Some repaired cracks are present on the outside surface of the tank. The condition of the interior of the concrete walls and roof are unknown.

Iron Sponge System

A new iron sponge unit was recently installed. The iron sponge unit is used for polishing the biogas. Ferric chloride is added to reduce the H₂S concentration in the biogas to below 35 mg/L. The biogas cleaning system also includes a siloxane removal system downstream of the iron sponge system as pretreatment for the methane fueled microturbines. No problem associated either with the iron sponge system or the siloxane removal system was noted.

Microturbines

There are three large and two small microturbine units. The microturbines produce enough hot water to maintain the primary digester optimal temperature at approximately 96°F (≈ 35.6 degrees Celsius [°C]). Only two units were running during the site visit. No problem associated with the microturbine units was reported.

Boiler

The boiler is put in service when the majority of microturbines are out of service. The boiler appeared fine during the site visit. No physical problem associated with the boiler structure or operation was reported.

Sludge Drying Beds

The sludge drying beds are unlined soil ponds. No physical problem associated with the sludge drying beds was reported. The District is considering two alternatives - lining the sludge drying beds in the future or replacing the drying beds with a biosolids thickening and drying system (i.e., a belt press or a centrifuge).

3.8 Building Structures

Shop Building

The galvanized-steel roof of the shop building is significantly corroded (Photo B-47) and leaks during rainy periods, which prevents use of the building. The building overhang is lightweight (Photo B-48), and the lightweight connections are corroded (Photo B-49).

Flushing Garage

This structure, located directly north of the administration building and west of the shop building, is used to park the vehicles and clean and wash the equipment. Minor corrosion of the galvanized-steel roof was observed; however, there were no reports of leaking.

Condition Summary

The shop building is old, and the roof is badly corroded. The leak through the roof prevents the staff from using the building. As part of upgrades, LCSD is considering new shop, garage, and laboratory building.

3.9 Plant Supervisory Control and Data Acquisition System

No problems were reported.

3.10 Yard Piping

No problems were reported.

4.0 Processes Performance Evaluation

The process performance at the reclamation plant was evaluated based on the plant water quality data. The plant provided the annual water quality data for 2006 to 2008. The 2008 records were used for the evaluation. The plant influent and effluent quality were discussed in the Background TM.

4.1 Low-TDS Treatment Train

Performance of the primary and secondary treatment processes in the low-TDS treatment train was evaluated. Table 4-1 presents the liquid stream characteristics based on BOD, TSS, and chemical oxygen demand (COD) values.

TABLE 4-1
Low-TDS Treatment Train Liquid Stream Quality based on 2008 Plant Data

Process Stream	Average Concentration		
	TSS - mg/L	BOD - mg/L	COD - mg/L
Plant Influent	200 (168-260)	223 (167-260)	493 (256-606)
Primary Clarifier No. 1 Effluent	65 (34-104)	--	--
Primary Clarifier No. 2 Effluent	59 (34-168)	--	--
Trickling Filter Effluent	54 (22-122)	--	--
Secondary Clarifier Effluent	33 (15-94)	--	--
Ultrafiltration Feed	28 (11-74)	48 (ND -103)	109 (ND-238)

Notes:
ND: nondetect

Numbers in parentheses present the data range measured in each stream throughout 2008.

Based on the average TSS values presented in Table 4-1, an average TSS removal efficiency of 76 percent via primary clarification was estimated. Typically, primary clarifiers remove 55 to 75 percent TSS. Hence, the estimated 76 percent removal indicates a very good clarification performance at the plant. One reason for such high TSS removal is due to ferric chloride addition to the headworks. Ferric chloride is primarily added as a coagulant for the removal of colloidal particles in the primary clarifiers while also reducing H₂S in the wastewater.

The trickling filter provides biological treatment for the low-TDS liquid treatment train. Due to the lack of BOD and COD data for the trickling filter influent and effluent streams, the actual trickling filter performance could not be determined. However, the trickling filter performance was estimated based on the following assumptions:

- An average BOD removal efficiency of 25 to 35 percent during primary clarification.

- No BOD reduction in the secondary clarifier or in the storage Pond A. Therefore, the BOD in the ultrafiltration feedwater reflects the BOD in the trickling filter effluent.

Using the above assumptions, the average BOD removal efficiency through the trickling filter is estimated between 67 and 71 percent, which corresponds to a marginal BOD removal for a biological treatment system. In addition, an average BOD of 48 mg/L in the ultrafiltration feed (Table 4-1) indicates that the trickling filter has inadequate performance. The trickling filter at the WWRP has no redundant unit, so any failure in the trickling filter could stress downstream treatment processes and might result in the plant discharge permit violations. In addition, as discussed in Section 3, the trickling filter structure has several noticeable cracks that allow water to leak through the cracks. The structure is considered failed in condition. Therefore, it is recommended that the District considers replacing the existing trickling filter soon or using other biological treatment processes.

The performance of the secondary clarifier is unknown due to lack of relevant data. The major issue with the secondary clarification is the reliability because of having no redundant facility. In addition, the existing secondary clarifier is shallow; therefore, a careful operation is required to maintain a sludge blanket to avoid clarifier failure. For future upgrades, it is recommended that the District consider:

- Adding a secondary clarifier with a similar size to increase capacity and improve reliability
- Replacing the existing clarifier with new clarifiers
- Eliminating the need for secondary clarifiers by using an MBR

Despite the frequent repairs in the existing ultrafiltration system, the plant effluent quality data indicate that the final effluent meets the turbidity requirements specified in Title 22 reuse water regulations. The ultrafiltration system is relatively new (approximately 5 years old). With some upgrades, modifications and replacement of the actuators and valves and corroding parts the system can stay in service.

4.2 High-TDS Treatment Train

Performance of the high-TDS treatment train was assessed based on the MBR permeate quality shown in Table 4-2.

TABLE 4-2
High-TDS Treatment Train Liquid Stream Quality based on 2008 Plant Data

Process Stream	Average Concentration		
	TSS - mg/L	BOD - mg/L	COD - mg/L
High-TDS Influent	158 (59-226)	126 (81-202)	353 (131-660)
MBR Permeate	3 (ND-68)	ND (ND-3)	23 (2-45)

Notes:

ND: nondetect

Numbers in parentheses present the data range measured in each stream throughout 2008.

The average TSS and BOD data in Table 4-2 show that the MBR was very effective in removing both BOD and TSS from the wastewater. This is consistent with a typical MBR

performance. The findings of condition assessment of the plant indicate that, with some upgrades and corrosion prevention, the MBR unit can remain in service.

A detailed evaluation of the RO system performance could not be provided due to the limited operating data. However, the effluent water quality data indicate that the plant meets the TDS, sodium, and sulfate requirements enforced by the WDRs. The historical data indicated slightly higher chloride concentrations than the enforced limit (TM 1-Background TM).

A medium-pressure UV system disinfects the combined flows of the treated low- and high-TDS streams. The existing UV system is relatively new and satisfies the Title 22 recycle water requirements for disinfection. However, the frequent back pulses in the Zeeweed ultrafiltration system result in significant flow fluctuations that alter the flow regime and cause UV dose fluctuations. The existing pipeline is short and has no capability to reduce turbulence in the pipeline feeding the existing UV system. The most effective solution is to add a break tank ahead of the existing UV system to minimize flow fluctuations and turbulence in the UV feed.

4.3 Solids Treatment

The sludge from the primary and secondary clarifiers is mainly digested in the primary digester. The secondary digester is primarily for sludge storage and does not provide mixing and temperature control. Table 4-3 presents a summary of the available data demonstrating the anaerobic digestion performance in 2008.

TABLE 4-3
Primary Digester Feed and Digested Sludge Solids and Volatile Solids based on 2008 Plant Data

Sludge	Annual Average		
	% Solids	% Volatile Solids	% Volatile Solids Reduction
Primary Digester Feed	3.8 (2-9)	74 (27-88)	58 (39-86)
Primary Digested Sludge	2.2 (2-3)	62 (56-66)	--
Secondary Digested Sludge	4.1 (2-6)	55 (43-60)	--

Notes

Numbers in parentheses present the data range measured in each stream throughout 2008.

Because the data in Table 4-3 do not include the digester flows, organic loading, and hydraulic retention time, evaluating the performance of the digesters was difficult. However, the primary digester performance was estimated based on the average percent solids and percent volatile solids data (Table 4-3), assuming equal influent and effluent flow rates through the primary digester. The estimation resulted in an average solids reduction of 51 percent.

Similar estimations, unfortunately, could not be made for the secondary digester because the increased percent solids in the secondary digester indicate that the inlet and outlet flows were not the same.

The solids reduction achieved by the primary digester falls within the values expected from a typical mesophilic digester. Despite the acceptable solids reduction, gas production in the digesters does not meet LCSD expectations. One potential reason for lower gas production is inadequate mixing and presence of dead zones in the digester. The other potential reason is the leak through the corroded steel cover and water seal of the primary digester. LCSD is now replacing the existing primary digester cover (steel cover) with a concrete cover, which may potentially improve the digester performance. It is recommended that LCSD consider converting the secondary digester to a primary digester to increase capacity and improve digester performance and reliability.

5.0 Conclusions

The condition of the reclamation plant was visually assessed from the electrical, structural, corrosion, and mechanical standpoints.

Generally, the electrical equipment at the plant is aged but well maintained. It may not be possible to replace the majority of the old equipment because the replacement might not be available. The major deficiencies include:

- The existing electrical service entrance, which is beyond the useful life and has no redundancy
- The motor control and variable speed equipment at the headworks, which are old and need to be retired
- Maintenance of some of the equipment in the Electrical/Control Building in the high-TDS treatment train, which might be as frequent as every 6 months to avoid unexpected shutdowns

Generally, the concrete in the treatment structures is in good condition with the exception of the trickling filter. The building structures do not seem to have any problems with the exception of the shop building. The major deficiencies include:

- The trickling filter structure has several deep vertical cracks and water leaks through the cracks – the structure is considered in bad condition.
- Pond A is poorly maintained, and soil is pulled with the water into the pipes. Lining the pond will alleviate this problem. Currently, a 1-mm strainer is installed ahead of the ZeeWeed membrane filtration system to prevent the membranes from having any potential damage.
- The canopy structure above the chemical storage area adjacent to the ultrafiltration structure needs to be evaluated for compliance to the building code lateral load requirements.
- The FRP cleaning tank was reported to be leaking. It is recommended that the tank be tested for leakage and repaired.
- The galvanized steel roof of the shop building is significantly corroded; and the roof leaks during the rainy season, which prevents use of the building

The existing pumps and pipes are old but well maintained and operational. No problems related to yard piping were reported.

For major plant equipment and unit treatment processes, the following key deficiencies were reported during site visit:

- Aging headworks infrastructure (already reached or exceeded its useful life) and lack of redundancy in the headworks equipment.

- Aging and corrosion-related issues in primary clarifiers.
- Lack of redundancy for the trickling filter, which severely reduces the plant reliability.
- Shallow secondary clarifier without redundant unit.
- Excessive repair needs and corrosion issues on the existing Zeeweed ultrafiltration system. With some repairs, modifications, and replacement of corroded parts, consideration can be given for operating the system in the future. Keeping the existing Zeeweed System or replacing with other technology will be further evaluated in Technical Memorandum 4 (Selection of Most Suitable Treatment Technology).
- The existing MBR system is generally in good condition with the exception of occasional membranes fiber breakage. The repair and maintenance is conducted on an as-needed basis. The MBR system can be kept in service with some repair and replacement.
- The steel cover of the primary digester is leaking due to material loss after blasting during the last coating repair. The welded-steel cover and the water seal are severely corroded. LCSD is currently replacing the existing steel cover with a concrete cover.
- Lack of redundancy in anaerobic digestion knowing that secondary digestion only serves as a holding tank in the absence of heating and mixing.
- Underneath the existing sludge drying bed area needs proper lining, if the current dewatering practice is continued. Other dewatering options (i.e., belt filter press, centrifuges, solar drying) need to be considered.

The plant process performance was evaluated based on limited historical water quality data from 2006 through 2008. Based on the available data, the overall plant performance is good and meets the regulatory requirements. There are few operational and performance-related issues that need improvement. These are:

- Lack of redundancy for the trickling filter, which severely reduces the plant reliability. Performance of the trickling filter is just marginal, which results in breakthrough of relatively high BOD to the ultrafiltration. High BOD supports biological growth on the membrane and increases membrane fouling and reduces permeability and membrane cleaning frequency. These factors contribute to high O&M cost. The existing trickling filter needs to be replaced with a new treatment process (i.e., new trickling filter, conventional activated sludge system, MBR).
- Frequent back pulses in the Zeeweed ultrafiltration system result in significant flow fluctuations that alter the desired flow regime in the UV system and cause fluctuations in the UV system. The existing flow arrangement has no capability to reduce turbulence in the pipeline feeding to the UV system. The most effective solution is to add a break tank ahead of the existing UV system to minimize flow fluctuations and turbulence in the UV feed.
- The solids reduction achieved by the primary digester falls within the values expected from a typical mesophilic digester. Despite the acceptable solids reduction, gas production in the digesters does not meet LCSD expectations. One potential reason for a lower gas production is inadequate mixing and presence of dead zones in the digester. The other potential reason is the leak through the corroded steel cover and water seal of

the primary digester. LCSD is now replacing the existing primary digester cover (steel cover) with a concrete cover, which may potentially improve the digester performance. It is recommended that LCSD consider converting the secondary digester to a primary digester to increase capacity and improve digester performance and reliability. Based on under-achieving performance of the existing gas generation system, LCSD is avoiding costly upgrades with the gas treatment and handling system in the future.

Appendix A

LCSD Wastewater Reclamation Plant Field Observations Data Log

LCSD Wastewater Reclamation Plant Facilities and Financial Master Plan Field Observations Data Log

ELECTRICAL SYSTEM AND EQUIPMENT EVALUATION		
Process / Equipment	Condition	Comment/Observation
Low TDS Liquid Treatment		
Existing Service Entrance Equipment	OK	Equipment is maintained but beyond useful life. Apparently last maintained in 1988. Replacement parts may be hard to find or expensive. No need to replace, just retire when original plant is retired. No redundancy, so reliability is prone to single failure from utility or anywhere in this equipment. Would require an extensive outage to replace this equipment.
Headworks – Motor control and variable speed equipment.	OK	Very old – replacements probably not available, should be retired with original plant. Would require an extensive outage to replace this equipment.
Remainder of Low TDS electrical equipment	OK	Old, but maintained. No recommendations.
High TDS Liquid Treatment		
Equipment in Electrical/Control Building	OK	Needs to be maintained – especially the blown in dust and particles blocking all filters on all equipment – may need to be serviced as frequent as every 6 months to keep equipment operating properly and avoid unexpected shutdowns.
Remainder of High TDS electrical equipment	OK	Maintained. No recommendations.

STRUCTURAL EVALUATION

Process / Equipment	Condition	Comment/Observation
Plant Overall	OK	<p>The plant has several maintenance issues but the concrete the structures, with the exception of the trickling filters, appear to be in good condition for their age (almost 50 years).</p> <p>The building structures and tanks did not appear to have any structural issues. The shop building has some issues.</p> <p>Most of the facilities have a maintenance or safety issue of one sort or the other.</p> <p>Jeremy told me that the primary clarifier mechanism base anchors are badly corroded. This is a serious issue if that is really the case.</p>
Headworks	OK	<p>Minor surface defects at grit area. Concrete generally ok (Photo 2534). Odd guardrail but probably ok (Photo 2533).</p> <p>Bar screen – This hatch is unsafe according to Jeremy. Chains keep pull off of it (Photo 2534)</p> <p>Spall at guardrail post base (Photo 2535). Fiberglass opening cover- I was warned that this would not carry a persons weight. Should be changed with a heavier cover (Photo 2536).</p> <p>Rusting embedded metal. Did not look like rebar (Photo 2537). Rusting rebar (Photo 2540)</p>
Primary and Secondary Clarifiers	OK	String holds up lighting (Photo 2542) .Launder surface rough, minor defect (Photo 2543)
Trickling filter	Not OK	Vertical shrinkage cracking (Photo 2454)

STRUCTURAL EVALUATION		
Process / Equipment	Condition	Comment/Observation
Ponds	Some unlined, poorly maintained	Shotcrete liner, shot on and no surface finishing done, no control joints, no edge forms (Photo 2549) Several small structures around pond, not sure if being used (Photo 2551). Spalled concrete at guard post (Photo 2552) Pond structures and elec needs maintenance (Photo 2553-2557)
Digesters		Concrete roof cracking, minor (Photos 2562, 2563)
Membrane Filters		Canopy structure, appears "light weight" (Photo 2561). Corrosion at the base of the steel tank (Photo 2570)
Shop Building		This building overhang looks a little light (Photo. 2572) Lightweight connections with corrosion (Photo 2573)

MECHANICAL AND UNIT PROCESSES EVALUATION			
Process / Equipment	Value	Condition	Comment/Observation
Headworks			
Number of Manual Screens	2	OK	
Number of Step Screens	1	OK	This is new installed in 2008. 3 mm opening. 3 hp/460Vac/3-phase/60-Hz, 1680RPM, TEFC, Class1, Div 2 motor; 3.25 Full Current Load Amps. Mfr. Huber, Model SSV Size 5300x476x6 at 70 degrees.

MECHANICAL AND UNIT PROCESSES EVALUATION

Process / Equipment	Value	Condition	Comment/Observation
Number of Wash Presses	1	OK	Has been in operation since 2008. 3.0 hp / 460Vac/3-phase/60 Hz motor, 4.4 amps
Aerated Grit with air lift	1	OK	Operating well with no reported problems
Grit Screw Conveyor	1	OK	Not operating during site visit, but no reported problems
Transfer Pumps in Grit Chamber to Hi TDS Pond	2	OK	Both look OK, well maintained and operational
Rotating Drum Screen(s)	2	OK	Both look OK, well maintained and operating well. 3 mm opening
Low TDS Liquid Treatment			
Low TDS Pond	1		Earthen berm. LCSD shotcreted the walls and planning to shotcrete the floor in the next year or 2
Number of Low TDS Pond Pumps	2	OK	Not able to observe during site visit. No problems reported
Low TDS Pond Aeration System Aeration Blowers	3	OK	Dedicated blower looks well, well maintained and operating well. Should check inlet filters to make sure they are clean. Standby unit common to both Low TDS and Hi TDS ponds.
Primary Clarification			
Appearance of Clarified Water (turbid, fine flocs, large flocs)			Effluent looked clean over the weir to the effluent launder. Traces of fines by scum collector.
Primary Clarifiers	<u>2</u>	OK	Exposed concrete looks OK. Mechanism looks old, but it is well maintained and operates well. The mechanism in primary clarifier closer to the Operations building has been in operation 15 years and the center column may not be firmly attached to the floor..

MECHANICAL AND UNIT PROCESSES EVALUATION

Process / Equipment	Value	Condition	Comment/Observation
Primary Sludge/Scum Pump	1 per primary clarifier	OK	The equipment looks old, but well maintained and operates well. Different types of pumps for each clarifier. The existing solids pump at each clarifier handles both primary sludge and primary scum.
Biofilters (Trickling Filters)			
Biofilter	1	<u>OK</u>	Exposed concrete looks old; there are vertical/repared cracks on the surface. Flow distribution arms look their age, but well maintained and operational Concern because this is the only piece of biological treatment and cannot be taken out of service; not even to change the media (which has not been changed in over 10 years)
Biofilter Feed/ Recirculation Pump	2	OK	The second pump has a sign stating "DO NOT OPERATE"
Condition of Ventilation System			This is a shallow tank (4-5 feet deep). No ventilation system.
Secondary Clarification			
Appearance of Clarified Water (turbid, fine flocs, large flocs)			Clarified water over the weir looks clear, some fines near the scum beach.
Secondary Clarifier	1	OK	Concrete looks OK_Mechanism looks old (but newer than mechanisms for primaries), but it is well maintained and operates well. Aluminum deflectors on the wall and FRP center baffle will be replaced in 2009. FRP will be replaced with SST.
Secondary Clarifier Sludge Pump	1	OK	Sludge pump looks OK, well maintained and operational.
Secondary Clarifier Scum Pump	1	OK	Scum pump looks OK, well maintained and operational.

MECHANICAL AND UNIT PROCESSES EVALUATION

Process / Equipment	Value	Condition	Comment/Observation
Secondary Effluent Equalization Basin (Storage Pond A)			
Pond A	1		<p>The existing flowmeter at the plant is located on the pipe that feeds the Secondary Effluent Equalization Pond (Pond A). The report uses this flow plus adding other flow and subtracting yet another flow. Mark didn't elaborate on which other flows are added and subtracted.</p> <p>There are 2 recent flowmeters that have been installed on the trunklines that convey the raw sewage to the WWTP. The volume capacity in Pond A is 1 million gallons.</p>
Zenon Zeeweed Membrane Filtration			
SE Feed Pumps	2	OK	40 hp/460-Vac/3-phase/60-Hz each
SE Strainers	1	OK	OK
Condition of Membrane Filtration System and Auxiliary Facilities including Chemical Feed System, CIP, Vacuum and Permeate Pumps			<p>Membranes fail at potting and need of to be repaired often (monthly). Valves need rebuilding often. Compressed air storage tanks have internal corrosion and will need replacement soon. The storage tanks for the chemicals are near the compressors and the fumes may be entering the compressors. May need to look at relocating the vents on the storage tanks to alleviate this problem or replace pneumatic actuators with electric actuators.</p>
High TDS Liquid Treatment			
High TDS Pond			
High TDS Pond	1		Earthen berm. LCSD planning to shotcrete the walls and floor in the next year or 2
High TDS Pumps to MBR	2	OK	Not able to observe during site visit. No problems reported

MECHANICAL AND UNIT PROCESSES EVALUATION

Process / Equipment	Value	Condition	Comment/Observation
High TDS Pond Aeration Blower	1	OK	Dedicated blower looks well, well maintained and operating well. Should check inlet filters to make sure they are clean. Standby unit common to both Low TDS and Hi TDS ponds
Membrane Bioreactor (MBR)			
Condition of Membrane Filtration System, Anoxic Mixer, and Auxiliary Facilities including Chemical Feed System, CIP, Vacuum and Permeate Pumps, Air Scour Blower System, Back Pulse Pumps and Storage System			Membranes are failing at potting and need to be repaired often. Already replaced . One of the permeate pumps (the one in the middle) has a fine layer of rust. Blowers look OK, except intake filters have some rust. Grilles on air conditioning units also have some rust
Return Activated Sludge (RAS) Pumps	2		No problems reported
Waste Activated Sludge (WAS) Valve	2		No problems reported
Reverse Osmosis			
Condition of RO System and Auxiliary Facilities including Chemical Feed System, CIP, High Pressure Feed Pumps			
UV Disinfection	4	OK	Look OK, well maintained and operational.
Recycle Water Pump Station			
Recycled Water Pumps	3	OK	Look Ok, well maintained and operational
Solids Treatment			
Anaerobic Digestion			
Primary Digester			
	1 Primary Digester, 1		There are some repaired cracks on concrete surface. Steel tank cover is leaking due to

MECHANICAL AND UNIT PROCESSES EVALUATION

Process / Equipment	Value	Condition	Comment/Observation
Condition of Primary Digester Including Mixing	Biogas Mixing Compressor		material loss after blasting during last coating repair. Outside surface of all exposed biogas piping looks OK. Biogas mixing compressor looks OK, it's well maintained and operational.
Iron Sponge	1	OK	New unit recently installed. This is for polishing. Use of ferric chloride reduces H ₂ S in biogas to 35 mg/L
Microturbines	5	OK	3 large units and 2 small units. Only 2 were running during visit, producing enough hot water to maintain the primary digester at temperature. The biogas cleaning system includes siloxane removal system downstream of the iron sponge.
Boiler	1	OK	Look OK. Runs when enough microturbines are out of service
Digested Sludge Holding Tank			
Condition of Digested Sludge Holding Tank	1	OK	There are some repaired cracks on outside surface. This tank has no mixing.
Sludge Drying Beds			
		OK	Earthen berms
Plant SCADA System			
		OK	No problems reported
Yard Piping			
		OK	No problems reported

Laguna County Sanitation District (LCSD) Water Reclamation Plant Condition Assessment

PREPARED FOR: Mary Vorissis/THO
PREPARED BY: James Albertoni/SAC
COPIES: Rod Jackson/SAC
DATE: April 30, 2009

Introduction

On April 22, 2009, CH2M HILL Corrosion Engineer James Albertoni visited the Water Reclamation Plant (WRP) to assess the condition of the existing facilities. The assessment did not include draining or entry into any water holding structures. The facility generally consists of two process trains, the low TDS process and the high TDS process.

The plant's treatment process includes grit removal, screening, primary clarification, bio filtration (tricking filter), secondary clarification and advanced membrane filtration. A portion of the flow (generally early morning), found to contain the highest level of influent salts, is diverted to a second treatment train. This train includes screening, suspended growth biological treatment (membrane bioreactor) and reverse osmosis (RO) treatment to reduce salts. The RO-treated wastewater is blended with the other tertiary treated waste stream and disinfected using ultraviolet irradiation. Recycled water is either distributed to user sites or stored in the tertiary holding pond and recycled water pipeline for later distribution. Biosolids generated during the treatment process are anaerobically digested to destroy pathogens and subsequently air dried on sludge drying beds.

The condition of each facility used in the plant is described below.

Confluent Vault

Two transmission pipelines enter the plant and combine flows in this vault. The combined flow is then directed to grit removal.

This vault is shown in Photo 1. The concrete vault appears to be in good condition with no signs of exposed aggregate including near the fluctuating water line. The iron gates show minor rust staining at area of coating damage, however, no significant corrosion of the gates was observed.

Grit Removal/High Salt Pumping Structure

The grit removal structure also serves as the pumping location where the early morning (high TDS) flows are pumped into the high TDS holding pond.

The wetted concrete surfaces of this structure are lined with what appears to be an epoxy. Only one area of previous lining damage was observed above the waterline, however this

area showed signs of exposed aggregate as shown in Photo 2. No areas of lining damage were observed near the water line. The lining generally appears to be in good condition and providing adequate protection of the concrete surfaces.

The grit removal equipment is constructed of stainless steel and is relatively new as shown in Photo 3. No signs of corrosion were observed on the stainless steel portions.

Submerged portions of the transfer pumps and piping were coated. No significant coating damage was observed, however observations could not be made below the waterline. The pumps and piping generally showed minor corrosion that appeared to be only cosmetic in nature as shown in Photo 4. The condition of the interior of the pump is unknown, however the pumps still function.

Handrails, grating, and supports appeared to be a mixture of anodized aluminum, painted steel, stainless steel, and painted galvanized steel. The paint was flaking off of the painted components, however no significant corrosion was observed. The anodized aluminum and stainless steel showed no signs of corrosion.

Screening

The screening structure includes a relatively new trashrack installed in a channel of the same age. This screening structure is only used on the low TDS water.

The entire concrete channel was lined however, it appears the lining prior to the trashrack was not able to bridge the bugholes and voids in the concrete surface as shown in Photo 5. The channel after the trashrack appeared to have a thicker lining and no obvious holidays or voids in the lining were observed. In general the concrete appeared to be in like new condition.

The trashrack was constructed of stainless steel. Corrosion staining was observed in some areas as shown in Photo 6, however no significant corrosion was observed.

The handrails, grating, and supports were constructed from a combination of plastic, stainless steel, aluminum, painted steel, and galvanized steel. The plastic appeared to be in good condition. The stainless and galvanized steel showed corrosion staining however no significant corrosion was observed. The aluminum showed no signs of corrosion. The painted steel steps down into the structure showed significant corrosion and in one area the step had corroded completely through as seen in Photo 7.

Primary Clarifier Influent Pump Station

Significant corrosion staining was observed on the exterior of the pumps and valves as shown in Photo 8. It was also reported by plant operators that some of the valves were corroded open, and some were operable, however the internals were significantly corroded so that water could pass even when the valve was in the off position.

Primary Clarifiers

The concrete surfaces of the primary clarifiers were not lined. Slightly exposed aggregate was observed in some areas, however no significant damage to the structure was observed. The concrete at the water line was in good condition. The water line is typically where the concrete damage is the worst. The weirs were in good condition.

The mechanism was not observed since the clarifiers were not drained. However, it was reported by the operators that the mechanism is corroded and the coatings are damaged. It was also reported that the bolts in the center column were recently replaced due to corrosion damage. Significant corrosion was observed on the scum beach and skimmer as seen in Photo 9. It was reported that corrosion perforations in the scum beach are frequently found and repaired.

The handrails and walkway supports appeared to be constructed of painted steel. The steel showed minor signs of corrosion. Large areas of coating damage were observed over the entire structure. The coatings will require frequent maintenance in order to prolong the life of the existing handrails.

Primary Clarifier Outlet Box

The primary clarifier outlet box was constructed of concrete and included several pipe penetrations. The concrete was lined, however several areas of lining damage were observed as shown in Photo 10. In general the concrete appears to be in fair condition. The pipe penetrations appear to have been coated after significant corrosion and metal loss had occurred. It appears the coating has prevented further corrosion of the pipe penetrations.

Primary Clarifier Effluent Pump Station

The primary clarifier effluent pump station includes the pumps and piping for the sludge that is moved to the digesters. The exterior of all of the pumps and piping are in good condition. Minimal areas of coating damage or corrosion staining were observed as shown in Photo 11. The interior condition of the piping, valves, and pumps are unknown.

Biofilter

The biofilter structure has several obvious cracks that appeared to penetrate through the concrete wall as shown in Photo 12. It was reported that water frequently leaks through these cracks. Other than the cracks, the concrete appears to be in fair condition with no signs of exposed aggregate. The amount of cracking is unknown at this time therefore the structure in general should be considered failed in condition.

The water distribution mechanism in the biofilter showed obvious signs of corrosion as shown in Photo 13, however the severity of the corrosion could not be observed in detail since it was still in operation.

Secondary Clarifier

The secondary clarifier was similar in condition to the primary clarifiers. Similar operational and maintenance issues were reported. Additionally, it was reported that the baffle adjacent to the weir was perforated due to corrosion below the waterline.

The perimeter handrails were constructed of anodized aluminum and were in good condition. The hose bibs and hose racks appeared to be constructed of galvanized steel. The galvanizing was corroding however corrosion of the underlying steel was not observed as shown in Photo 14.

Temporary Holding Pond

The temporary holding pond is a soil pond as shown in Photo 15. It was reported that soil can get pulled in with the water and therefore requires filters prior to microfiltration.

Microfiltration Pump Station

The microfiltration pump station is constructed of lined concrete. The concrete and lining appear to be in good condition with no lining or concrete damage observed as shown in Photo 16. The gates were located under an overhang however appear to be in at least fair condition. No obvious corrosion was observed and no issues were reported.

The pumps and above ground piping and valves were a combination of coated steel and coated ductile iron. Several large areas of coating damage were observed in this area as shown in Photo 17. At areas of coating damage, significant corrosion had occurred however minor metal loss was only observed in a few locations.

Digesters

There are two digesters at the plant, a primary and secondary digester. The primary digester consists of a concrete tank with a welded steel fixed cover with a water seal. The secondary digester consists of a concrete tank with a concrete cover with a water seal.

The primary digester influent and overflow boxes were constructed of lined concrete. The concrete appeared to have some minor damage. The condition of the interior of the concrete tank walls is unknown. It was reported that the water seal and welded steel cover were severely corroded and that plans for replacement were underway.

The secondary digester lined concrete boxes showed signs of exposed aggregate prior to the lining. The condition of the interior of the concrete walls and roof are unknown. It was reported that repairs were required for the water seal due to severe corrosion.

Microfiltration

The microfiltration area consists of the microfiltration structure, a cleaning chemical area, an electrical area, and cleaning tank. The cleaning chemical area and electrical area were housed beneath the same shade structure, directly adjacent to the microfiltration structure.

The FRP cleaning tank appeared to be leaking, as seen in Photo 18, and it was reported that the tank bottom had cracked from the alternating pressures associated with the filling and draining of the tank.

The interior of the microfiltration structure could not be observed as it was not drained at the site visit.

The conduit supports, unistruts, electrical boxes, electrical enclosures, and structural steel in the chemical cleaning and electrical area were constructed of coated steel. The components closest to the sodium hypochlorite and the microfiltration structure showed significant coating damage. At the areas of coating damage, significant corrosion staining was observed however the corrosion appeared to be mostly cosmetic in nature as seen in Photo 19. It was reported that during the microfiltration daily cleaning that a strong sodium hypochlorite smell overpowers the area surrounding the microfiltration structure.

The non-metallic items in this area appear to be in good condition.

High TDS Pond

The early morning flows into the plant generally have the highest TDS. The early morning flows are diverted from the grit removal area to the high TDS pond. The high TDS pond is a soil pond with a concrete pumping vault.

The concrete of the vault was in good condition with no exposed aggregate observed. The coated steel supports associated with the pump guides were in poor condition. The coating was nearly completely missing and corrosion with minor metal loss was beginning to occur as seen in Photo 20. The coated pumps appeared to be in good condition. The stainless steel guides and sidewalk doors were also in good condition.

Low TDS Pond

The low TDS pond is filled with diverted low TDS water throughout the day. During the early morning, when the high TDS water is diverted from the original process train, the low TDS pond is used to supply water through the original process train. The low TDS pond was recently reconfigured with a CLSM liner for the sloped walls. The CLSM was not included for the floor of the pond. The low TDS pond also has a concrete pumping vault.

The concrete of the vault was in good condition with no exposed aggregate observed, as seen in Photo 21. The coated steel supports associated with the pump guides were in fair condition. The coating was missing in several areas and corrosion was beginning to occur. The coated pumps appeared to be in good condition. The stainless steel guides and sidewalk doors were also in good condition.

High TDS Screenings

The high TDS screenings consisted of two sets of screeners. The second set of screeners was installed recently and mirrored the original set. The screeners are stainless steel.

The screening mechanisms appeared to be in good condition. The older set of screeners showed some corrosion staining however it was cosmetic in nature as seen in Photo 22.

The walkway and walkway supports surrounding the screeners were constructed of coated steel. The newer screener walkway was in good condition with no coating damage or corrosion observed. The older screener walkway showed multiple small areas of coating damage. At areas of coating damage, significant corrosion and metal loss was observed as seen in Photo 23. Because of the infrequency of coating damage, the walkway was generally in fair condition.

Membranes

The membranes structure consists of steel tanks with a plastic grating overhead and painted steel handrails. The steel tanks were generally in good condition. However it was reported that the process drains and walkway drains were interconnected. The result was that process water, including chemical cleaning water, would backup the drains and pond near the base of the coated steel membrane structure. As a result significant coating damage and corrosion were observed at the base of the tank and nearby buildings as seen in Photo 24.

The plastic grating was in good condition. The coated steel handrails were generally in good condition with only minor coating damage and corrosion staining observed.

Membrane Blowers

The membrane blowers were generally in good condition although significant coating damage and corrosion was observed on the exhaust in small isolated areas as seen in Photo 25. The cause of this corrosion is unknown.

Membrane Chemical Building

The membrane chemical area was constructed of mostly plastic piping, with metallic water pumps, coated steel unistruts, pipe supports, floor, electrical boxes, etc. enclosed in a coated steel building.

The non-metallic items were in good condition. No obvious signs of degradation were observed and no issues were reported.

Similar to the microfiltration chemical area, the coated steel showed corrosion staining over the majority of the surfaces. The floors and supports attached to the floor showed significant corrosion with minor metal loss as seen in Photo 26. It appears the drains can backup and cause ponding within the building accelerating corrosion of the floor.

It appears that some various items were un-coated steel, such as washers and fasteners. These un-coated items were corroding over the entire surface and metal loss was beginning to occur as seen in Photo 27.

General Chemical Area

The main chemical storage area consisted of holding tanks, metering pumps, and a roof structure. The majority of the facility was in good condition. The coated steel tank anchor elbows showed coating damage and corrosion staining as seen in Photo 28. No metal loss was observed as of yet.

Reverse Osmosis

The RO units appeared to be in good condition. The stainless steel piping and coated steel support structure were in good condition as well as the prefabricated building. The stainless steel piping showed corrosion staining in some areas, however, the staining was cosmetic in nature as seen in Photo 29. The condition inside of the stainless steel piping is unknown.

Ultra Violet

The UV treatment consisted of UV lights inline with abovegrade piping. The exterior of the piping and UV units were in good condition. The condition inside of the piping and UV units is unknown.

Final Pond

The final storage pond is a soil pond. It was reported that this pond will be replaced with a large diameter abovegrade concrete storage tank to minimize soil entering the finished water.

Plant Effluent Pump Station

The effluent pump station consists of abovegrade coated steel piping and coated pumps. The exterior of the piping and pumps are in good condition with only small areas of coating damage and corrosion staining as seen in Photo 30. No issues were reported on the operation of the pumps, however, the condition inside the piping and pumps is unknown.

Shop Building

Corrosion of the galvanized steel roof of the shop building was observed as seen in Photo 31. It was reported by operations staff that the roof leaks during periods of rain and prevents use of the shop.

Vehicle Wash Building

Minor corrosion of the galvanized steel roof was observed however, there were no reports of leaking.







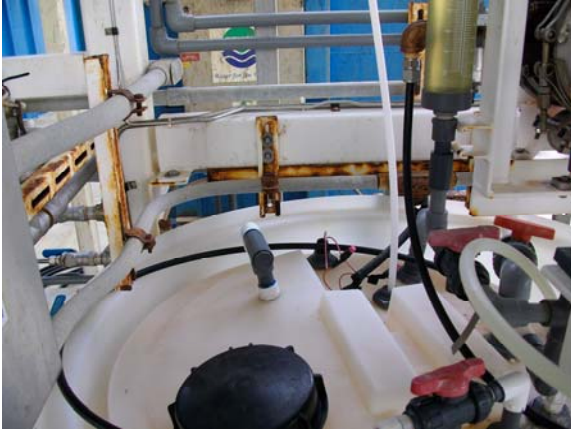





Appendix B
Photos of Wastewater Treatment Reclamation Plant



B-1



B-2



B-3



B-4



B-5



B-6



B-7



B-8



B-9



B-10



B-11



B-12



B-13



B-14



B-15



B-16



B-17



B-18



B-19



B-20



B-21

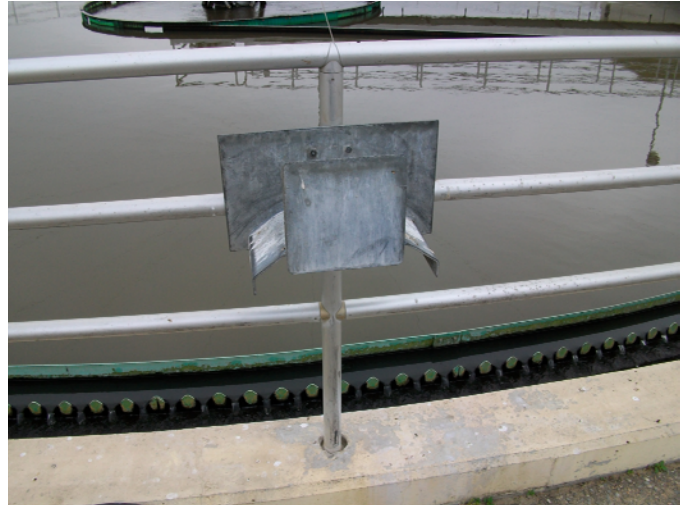

B-22



B-23



B-24



B-25



B-26



B-27



B-28



B-29



B-30

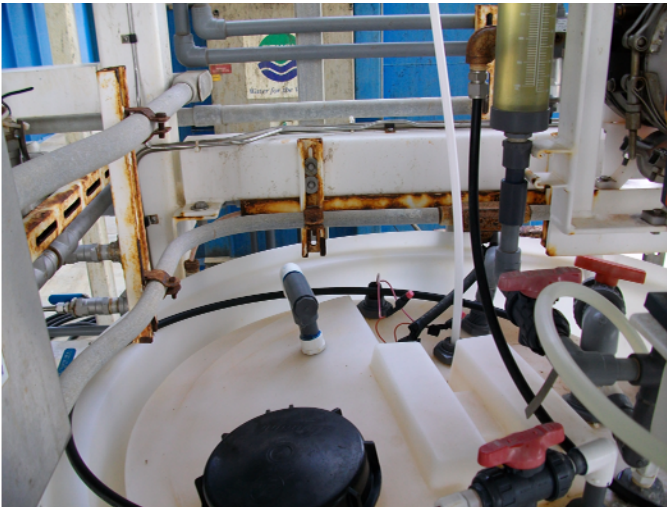

B-31



B-32



B-33



B-34



B-35



B-36



B-37



B-38



B-39



B-40



B-41

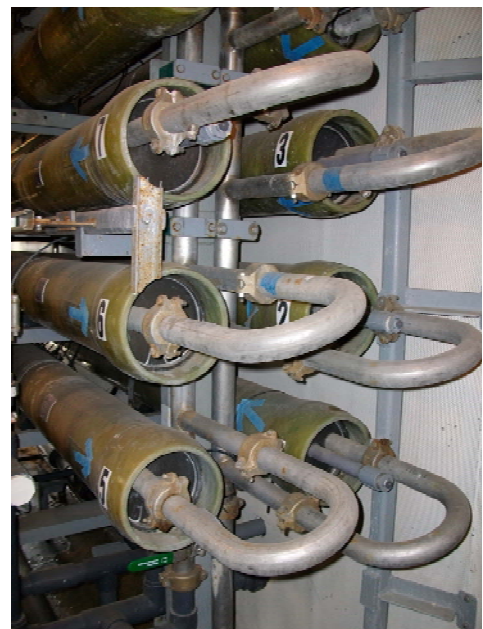

B-42



B-43



B-44



B-45



B-46



B-47



B-48



B-49

Appendix C
Photos of Wastewater Treatment Reclamation Plant Electrical
System

Existing Service Entrance Equipment



C-1



C-2

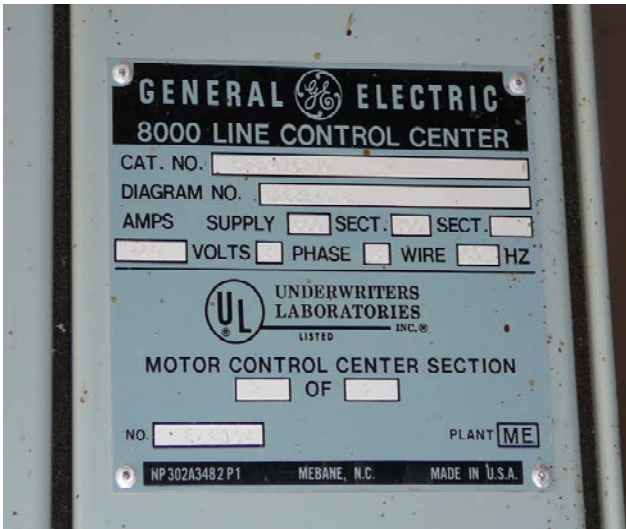

C-3



C-4

Headworks

Motor Control and Variable Speed Equipment



C-5



C-6



C-7



C-8



C-9

Low-TDS Treatment Train Electrical Equipment



C-10



C-11



C-12



C-13



C-14



C-15

High-TDS Treatment Train Equipment in Electrical /Control Building



C-16



C-17

Treatment Alternatives Screening and Short-listing of Treatment Alternatives

PREPARED FOR: Laguna County Sanitation District
 PREPARED BY: CH2M HILL
 DATE: September 22, 2009

Contents

1.0	Objectives	1-1
2.0	Background.....	2-2
2.1	Brief Description of Plant Facilities.....	2-2
2.2	Evaluation Boundaries.....	2-5
	2.2.1 Raw Wastewater Characterization.....	2-5
	2.2.2 Effluent Water Quality Requirements	2-8
2.3	Redundancy and Reliability Requirements	2-10
	2.3.1 Plant Operation and Net Present Value Components	2-10
3.0	Evaluation of Treatment Technologies	3-1
3.1	Liquid Treatment Technologies for Secondary Treatment.....	3-1
	3.1.1 Trickling Filters.....	3-1
	3.1.2 Oxidation Ditch Activated Sludge System	3-3
	3.1.3 Membrane Bioreactors	3-4
3.2	Tertiary Filtration Technologies	3-7
	3.2.1 Membrane Filtration	3-7
	3.2.2 Depth Filtration	3-9
	3.2.3 Surface Filtration	3-10
3.3	Disinfection	3-13
3.4	Solids Handling	3-13
	3.4.1 Sludge Thickening.....	3-13
	3.4.2 Sludge Stabilization Technologies	3-16
	3.4.3 Sludge Dewatering Technologies.....	3-23
3.5	Energy Considerations	3-26
4.0	Short Listing of Treatment Alternatives via Non-Monetary Criteria.....	4-1
4.1	Non-Monetary Criteria.....	4-1
4.2	Benefit Scores for Treatment Alternatives	4-4
	4.2.1 Benefit Scores for Secondary Treatment Alternatives.....	4-4
	4.2.2 Benefit Scores for Tertiary Filtration Alternatives	4-5
	4.2.3 Benefit Scores for Sludge Stabilization Alternatives	4-6
5.0	Short-Listed Treatment Alternatives	5-1

Tables

- 2-1 WWRP Current Flows and Estimated Peaking Factors
- 2-2 WWRP Projected Year 2030 Flow Rates
- 2-3 WWRP Current Raw Sewage Quality
- 2-4 Future High-TDS Stream Scenarios
- 2-5 WWRP Effluent Water Quality Requirements
- 2-6 The WRRP Current Electricity, Chemical, and Sludge Disposal Costs
- 3-1 Comparison of Secondary Treatment Technologies
- 3-2 Comparison of the Tertiary Filtration Technologies
- 3-3 Representative Sludge Stabilization Technologies
- 4-1 Non-Monetary Criteria, Criteria Definition, and Assigned Weighting Factors for the Secondary Treatment and Tertiary Filtration Options
- 4-2 Solids Treatment Qualitative Criteria and Associated Definition/Measures

Figures

- 2-1 LCSD WWRP Site Layout
- 2-2 LCSD WWRP Process Flow Schematic
- 3-1 Process Flow Schematic of a Trickling Filter with Solids Contactor
- 3-2 Process Flow Schematic of a CAS for BOD and Nitrogen Removal
- 3-3 Process Flow Schematic of an Oxidation Ditch Activated Sludge Systems
- 3-4 Process Flow Schematic of an MBR
- 3-5. Schematic of a Typical Submerged Membrane Filtration System
- 3-6 Picture of a DynaSand Facility
- 3-7 A Full-Scale Hydrotech Disc Filtration Facility
- 3-8 Picture of a Typical Rectangular DAFT
- 3-9 Picture of a Typical GBT
- 3-10 Picture of a Typical Thickening Centrifuge
- 3-11 Picture of a Typical RDT
- 3-12 Flow Schematic of an Acid-Gas Phase Digestion
- 3-13 Process Flow Schematic of a CAMBI Process
- 3-14 Process Flow Schematic of CANNIBAL Process
- 3-15 Process Schematic of Solar (Greenhouse) Drying Process (Huber Technology shown)
- 3-16 Picture of a Typical BFP
- 3-17 Picture of a Typical Rotary Press
- 4-1 Benefit Evaluation for Secondary Treatment Alternatives
- 4-2 Benefit Evaluation for Tertiary Filtration Alternatives
- 4-3 Benefit Evaluation for Sludge Stabilization Alternatives

1.0 Objectives

Laguna County Sanitation District (LCSD or District) is conducting a “Facilities and Financial Master Plan” for LCSD wastewater reclamation plant (WWRP). The objectives of the master plan are to define future wastewater flows and loads, project future treatment requirements, establish expansion needs, identify viable liquid and solids treatment alternatives, and develop a plan for implementation. Future wastewater flows and loads as well as treatment requirements were defined in Technical Memorandum 1 (TM 1) “LCSD Facilities and Financial Master Plan-Background Information.”

Objectives of this Technical Memorandum (TM 3) are to identify and screen potential liquid and solids treatment alternatives and short list up to six treatment alternatives based on nonmonetary criteria. In TM 4, the short-listed treatment alternatives will then be evaluated in a 20-year life cycle cost basis to identify the treatment alternatives that exhibit the highest benefit to cost ratios.

2.0 Background

2.1 Brief Description of Plant Facilities

LCSD owns and operates a WWRP, located at 3500 Black Road in Santa Maria, California. Currently, the WWRP serves the community of Orcutt, portions of unincorporated southern Santa Maria, and portions of the city of Santa Maria in North Santa Barbara County, California. Wastewater is generated primarily from domestic sources with minor contributions from commercial establishments. The WWRP site layout is provided in Figure 2-1, showing the existing treatment units and the available site for the future expansion. Figure 2-1 indicates that there is sufficient land for future expansion.

The initial WWRP was built in 1959. The initial capacity was 1.6 million gallons per day (mgd). The WWRP capacity was increased to 2.4 mgd in 1974 and further to 3.2 mgd in 1986. The WWRP treated wastewater to undisinfected secondary treatment levels, which was stored in holding ponds onsite before being pumped to site and offsite locations for spray irrigation on surrounding pasture¹. In 2004, LCSD constructed upgrades to the reclamation plant to address water quality issues, including total dissolved solids (TDS), sodium, and chloride. With the completion of the 2004 upgrades and expansion, the WWRP had capability to produce 3.7 mgd of Title 22 disinfected tertiary recycled water for unrestricted reuse. The 2004 expansion also included a new 0.5-mgd treatment train to treat the high TDS wastewater produced by the nightly regeneration of water softeners.

The WWRP currently treats an average flow of 2.0 mgd. Wastewater flows enter into the facility headworks, which consists of screening and grit removal, before being directed to one of the two treatment trains: a high-TDS or low-TDS train. The 3.2-mgd low-TDS train consists of a step screen, low-TDS flow equalization pond, two primary clarifiers, a biofilter (trickling filter), a secondary clarifier, a flow equalization basin, strainer (1-millimeter [mm]), and Zenon ZeeWeed® ultrafiltration units. The 0.5-mgd high-TDS train consists of a rotary drum screen (1 mm), high-TDS flow equalization pond and associated pump, the Zenon Zenogem® membrane bioreactor (MBR), and a reverse osmosis (RO) systems (four units with three units in use). RO concentrate is conveyed to a U.S. Environmental Protection Agency (USEPA) Class 2 nonhazardous injection well via gravity.

TREATMENT ALTERNATIVES SCREENING AND SHORT-LISTING OF TREATMENT ALTERNATIVES

C:\DOCUMENTS AND SETTINGS\WLANOMTMY\DOCUMENTS\UFUK\LCSD TM3_WL976.DOC
COPYRIGHT 2010 BY CH2M HILL, INC. • COMPANY CONFIDENTIAL

II

GEN050410064106SCO/101270001

II

¹1959 to 1973 – Irrigation to sugar beets. Winter flows chlorinated and discharged to Brown Ditch and Santa Maria River
1973 to 1980's – Irrigation to sugar beets. Winter storage with reservoirs and ponds.
1980's to 2004 – Irrigation to cattle pasture and winter storage in reservoirs and ponds

The high- and low-TDS treatment trains rejoin before the ultraviolet (UV) disinfection system, and their combined flow is then stored in the recycled water forebay (to be replaced with a storage tank in 2009) before being pumped into the recycled water distribution system (RWDS) or to the recycled water upper storage reservoir if demand is low. Design criteria and condition review for the existing facilities were previously summarized in TMs 1 and 2, respectively.

Current offsite users include agricultural users, and a landscape irrigation project is proposed in Fiscal Year (FY) 2009-2010. Water not used on demand is stored in the main reservoir or lower storage ponds. The stored water is used on beet cattle pasture. Higher agricultural uses would require additional treatment such as re-disinfection of stored water.

The sludge generated from the primary and secondary clarifiers is digested in anaerobic digesters and dewatered in solar sludge drying beds. The dewatered biosolids are hauled offsite to a private composting facility. The process flow schematic of the plant is given in Figure 2-2.

Although capacity of the existing plant is adequate to treat current flows and increased flows that will occur next 3 to 5 years, the majority of unit treatment processes such as headworks, trickling filter and MBR facilities is old and needs replacement. In addition, key treatment processes including the trickling filter and the secondary clarifier have no redundant units, which reduce the operational flexibility and reliability of the plant. Existing sludge drying beds are not lined. However, if these facilities need to remain in service, LCSD is considering lining the drying beds to protect groundwater quality. Utilizing existing infrastructure for upgrade may offer cost savings on capital investment. Site visit findings indicate that few process units including the primary clarifiers, UV disinfection, and anaerobic digestion facilities are in good condition. Therefore, in this TM, consideration is given to the use of available infrastructure as part of screening and selection of treatment alternatives.

FIGURE 2-1
LCSD WWRP Site Layout



FIGURE 2-2
LCSD WWRP Process Flow Schematic

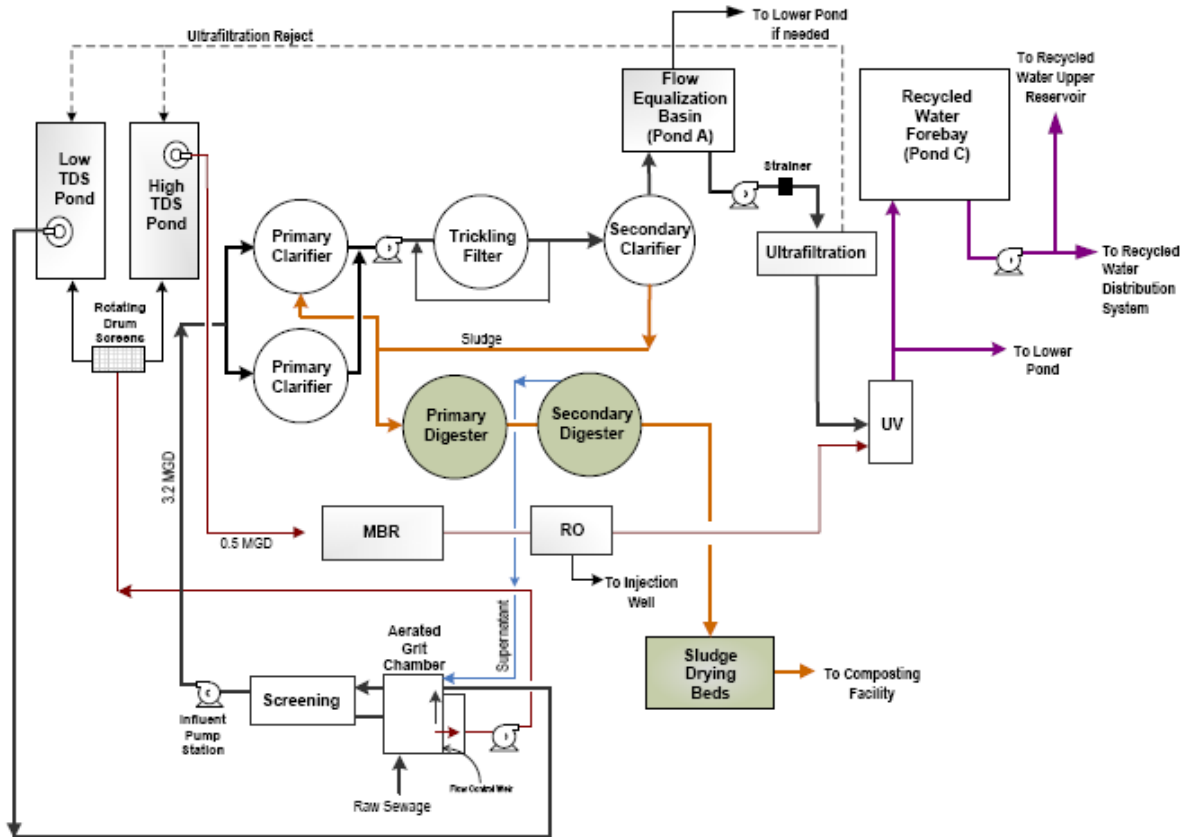

2.2 Evaluation Boundaries

It is imperative that the project boundaries are defined and key assumptions are made before starting screening of the treatment alternatives. The key components of the project boundaries include raw wastewater characterization (i.e., flows, water quality, and peaking factors) and discharge requirements for treated wastewater for the WWRP current and anticipated future operating conditions.

2.2.1 Raw Wastewater Characterization

The WWRP current flows and peaking factors are presented in Table 2-1. Assumptions made in the absence of historic flow monitoring data to account for design flow conditions are presented in the bottom of Table 2-1.

TABLE 2-1
WWRP Current Flows and Estimated Peaking Factors

Parameter	Value
Average Dry Weather Flow, mgd	1.78
Average Wet Weather Flow, mgd	2.07
Average Annual Flow, mgd	1.90 ^a
Peak Dry Weather Flow (1hr duration), mgd	3.44
Peak Wet Weather Flow (1 hr duration), mgd	4.27
Instantaneous Peak Flow (5- to 15-minute duration Interval)	4.40
Maximum Monthly Flow to Average Dry Weather Flow Ratio	1.10 ^b
Peak Dry Weather to Average Dry Weather Flow Ratio	1.93
Peak Wet Weather to Average Dry Weather Flow Ratio	2.40

^a Estimated taking the weighted average of the average dry and wet flows. Estimation assumed 5 months of wet season and 7 months of dry season.

^b Values typically vary between 1.10 and 1.20 for WWTPs treating domestic sewage. A value of 1.10 was assumed for the purpose of this study. Design practices generally use maximum monthly flow to size primary and secondary treatment systems (i.e., primary clarifiers, activated sludge basins, trickling filters, secondary clarifiers).

The projected future (2030) average annual flow rate for WWRP is 5.0 mgd according to TM 1. The peaking factors presented in Table 2-1 were then applied to the future average flow of 5.0 mgd to estimate the planning values for the Year 2030 maximum month, peak dry, and wet weather flow rates. The estimated future flow rates are presented in Table 2-2.

TABLE 2-2
WWRP Projected Year 2030 Flow Rates

Parameter	Value
Average Annual Flow, mgd	5.00
Maximum Monthly Flow, mgd	5.50
Peak Dry Weather Flow (1-hr duration), mgd	9.65
Peak Wet Weather Flow (1-hr duration), mgd	12.0

Following headworks, wet weather flows and peak diurnal flows and loads are dampened by the onsite flow equalization ponds (low- and high-TDS ponds). The primary, secondary, and tertiary treatment facilities of WWRP are not currently exposed to diurnal flows and loads, which would ordinarily stress the treatment facilities. This offers operational flexibility and substantial savings on power cost. For this reason, consideration is given for using existing flow equalization basins in the plant expansion.

Table 2-3 presents average concentrations of key wastewater constituents in WWRP influent for current operation conditions. Raw wastewater is predominantly domestic, and the planning studies summarized in TM 1 indicate that the WWRP will continue to treat domestic sewage in the future. With the exception of TDS, concentration of constituents in WWRP influent was assumed to remain the same for the current and future WWRP scenarios. WWRP

currently receives low- and high-TDS streams and treats them in separate treatment trains. Regeneration of residential water softeners contributes to the high-TDS stream.

TABLE 2-3
WWRP Current Raw Sewage Quality

Constituent	Concentration
Five-Day Biochemical Oxygen Demand (BOD5), mg/L	232
Total Suspended Solids (TSS), mg/L	210
Ammonia-N, mg/L	29
Total Kjeldahl Nitrogen (TKN), mg/L	42
Average Low Total Dissolved Solids (TDS), mg/L	767
Average High TDS, mg/L	1,758
Combined TDS, mg/L	910

At the early stage of the project, the following high-TDS scenarios were considered for the evaluation.

Scenario 1

Assumes that water-softening ordinances will not be implemented, with new connections adding to the high-TDS stream at the same rate as received today. It simply assumes that the WWRP will receive high TDS as in the current period (5:00 a.m. to 10:00 a.m.) but with an increased flow. WWRP will continue to receive both low-TDS and high-TDS streams at the flow and concentrations presented in Table 2-4. Under this condition, some additional MBR and RO treatment is required to meet the Water Discharge Requirements (WDR) TDS requirement.

Scenario 2

Assumes that water-softening ordinances will be implemented for the new connections and that the WWRP will continue to treat high-TDS flows up to the existing capacity of 0.5 mgd. While the WDR TDS requirement can be satisfied without additional RO treatment, the stringent chloride limit may require additional RO treatment under this condition. A mass balance for chloride needs to be performed to accurately determine if additional RO treatment is actually needed. Based on flow and TDS contributions of low- and high-TDS stream, it is expected that the current RO system with four RO units can provide adequate treatment for chloride.

Scenario 3

Assumes that all high-TDS discharges from water softeners are eliminated, and future TDS concentration will be equivalent to the current low-TDS concentration. With the elimination of the regenerative type water softeners, there will no longer be a high-TDS stream. While the WDR TDS requirement can be satisfied without additional RO treatment, the stringent chloride limit may require some RO treatment under this condition. A mass balance for chloride needs to be performed to accurately determine if additional RO treatment is actually needed. Based on flow and TDS contributions of low- and high-TDS streams, it is

expected that the current RO system with four RO units can provide adequate treatment for chloride.

TABLE 2-4
Future High-TDS Stream Scenarios

Constituent	Scenario 1	Scenario 2	Scenario 3
High-TDS Stream Flow Rate, mgd	0.76	0.50	0
Average High TDS, mg/L	1,758	1,758	N/A
Is the Existing RO Facility Sufficient to Handle Increased TDS and Chloride Load?	No. Additional RO units (trains) should be added	Yes (the fourth RO unit may be brought in service)	Yes (the fourth RO unit may be brought in service)

N/A: not applicable

As the project proceeds, LCSD indicated that the District is not expecting additional high-TDS flows from the new connections while expecting that the WRP will continue to receive high-TDS stream from the existing connections, thereby suggesting that only Scenario 2 is closely simulating future high-TDS flows. In addition, LCSD indicated that the City of Santa Maria is planning to divert a high-TDS flow of approximately 62,000 gallons per day to the WRP following completion of new headworks at the WRP. This will increase future high-TDS flow to approximately 0.6 mgd and will require expansion of the existing MBR facility and necessitate bringing the fourth RO unit in service.

2.2.2 Effluent Water Quality Requirements

The treated effluent of WWRP should meet the WDRs and Title 22 all-purpose reuse water quality criteria presented in Table 2-5.

TABLE 2-5
WWRP Effluent Water Quality Requirements

Parameter	Requirement
Turbidity	Not to exceed 0.2 NTU more than 5 percent of the time during a 24-hour period Less than 0.5 NTU at all times
Total Coliform	2.2 MPN per 100 mL per sample, median reading not to exceed over any 7-day continuous period 23 MPN per 100 mL per sample, not to occur more than once within 30 days
Biochemical Oxygen Demand (BOD5)	10 mg/L (12-month running average) 25 mg/L (Maximum)
Total Suspended Solids	10 mg/L (12-month running average) 25 mg/L (Maximum)
BOD5	10 mg/L (12-month running average) 25 mg/L (Maximum)
Settleable Solids	0.1 mg/L (Maximum)
Oil and Grease	1 mg/L (12-month running average)

TABLE 2-5
WWRP Effluent Water Quality Requirements

Parameter	Requirement
	5 mg/L (maximum)
Dissolved Oxygen (DO)	≥ 2 mg/L
Dissolved Sulfide	≤ 0.1 mg/L
Total Dissolved Solids (TDS)	900 mg/L (12-month running average)
Sodium	180 mg/L (12-month running means)
Chloride	150 mg/L (12-month running means)
Sulfate	300 mg/L (12-month running means)
Boron	0.5 mg/L (12-month running means)

Notes:

NTU = _____

MPN = most probable number

mL = milliliter

mg/L = milligrams per liter

California Department of Public Health (CDPH) is continuously reviewing the ongoing research on disinfection by-products (DBPs) and emerging contaminants that can be found in wastewaters. The most recent CDPH Ground Water Recharge (GWR) regulations set an action limit of 10 nanograms per liter (ng/L) for nitrosodimethylamine (NDMA) and recommended monitoring of up to 25 emerging contaminants in GWR projects. Although these compounds are yet to be regulated, some or all monitored contaminants will more likely be regulated in the future, thereby indicating that treatment plants should be designed in flexibility where advanced treatment facilities can easily be coupled with the secondary treatment facilities to meet stringent future water quality requirements. Therefore, future plant expansion should consider treatment options, or sufficient flexibility to meet more stringent future discharge regulations. In addition, full-scale operation and pilot testing studies indicate that the performance of tertiary filtration technologies (i.e., membrane filtration, cloth media filtration) is primarily dependent on the secondary treatment provided prior to filtration. The studies show that trickling filters and conventional activated sludge systems operated at very short solids retention times (SRTs) (non-nitrifying mode, SRT of 2 days or less) cause significant fouling problems on the tertiary filters, which reduce productivity, increase cleaning requirement and filtration downtimes, and in some instances increase chemical consumption and replacement frequency of filtration apparatus (i.e., membrane filtration). The WWRP currently employs a submerged membrane filtration system, which is inherently subjected to the increased fouling because of the limited degree of treatment provided by the biofilter.

For the foregoing reasons, any activated sludge systems (i.e., conventional activated sludge system, MBR) will provide an SRT of no less than 5 days to allow biodegradation of slowly biodegradable compounds.

2.3 Redundancy and Reliability Requirements

Existing secondary treatment unit processes including trickling filter, secondary clarifier, and anaerobic digester do not have redundant units such as at least one or more processes with similar functions in standby. This significantly reduces plant reliability. In this evaluation, the firm operating capacity will be established considering one process unit out of service while satisfying all the target water quality and permit limits.

2.3.1 Plant Operation and Net Present Value Components

The WWRP is currently operated 10 hours a day and 7 days a week. This operating scheme will be considered for sizing and costing solids handling facilities.

Cost estimates of the net present value (NPV) of the technology alternatives will be developed by obtaining budgetary-level equipment costs from equipment suppliers and calculating facility costs using CH2M HILL's proven cost estimating methodology (CPES) for projects of similar type and size.

The cost estimates developed for this analysis provide a relative comparison of the treatment alternatives and are considered "order-of-magnitude" estimates. An order-of-magnitude cost estimate is defined as "an approximate estimate made without detailed engineering data." The Association for the Advancement of Cost Engineering (AACE) International defines order-of-magnitude costs as *Class 5* cost estimates without detailed engineering data. Examples of order-of-magnitude costs include: (1) an estimate from cost capacity curves, (2) an estimate using scale-up or scale-down factors, and (3) an approximate ratio estimate. The estimates shown, and any resulting conclusions on project financial or economic feasibility or funding requirements, have been prepared to guide project evaluation and implementation from the information available at the time of the cost estimation. The expected accuracy ranges for a Class 5 cost estimate are -15 to -30 percent on the low side and +20 to +50 percent on the high side. The final costs of the project and resulting feasibility will depend on actual labor and material costs, competitive market conditions, actual site conditions, final project scope, implementation schedule, continuity of personnel and engineering, and other variable factors.

Capital cost reflects construction costs for the facilities and does not include engineering and design or legal fees. The following markups and contingencies (as an additional percentage of the construction cost amount) were included in the facility costs:

- Mobilization: 10%
- Bond/Permits and Insurance: 3.5%
- Contractors Overheads: 15%
- Contractor Profit: 8%
- Project Contingency: 25%

The chemical, energy, and sludge disposal costs obtained from LCSD and presented in Table 2-6 will be used for comparing treatment alternatives in a 20-year life cycle cost (LCC) basis at 6 percent discount rate. LCC is the total cost of ownership of equipment and technology, including its cost of acquisition, operation and maintenance, and decommission. It takes into account the costs associated with consumables (chemicals, energy); part

replacement (i.e., membrane replacement, cloth media replacement); and labor and is a very effective and unbiased method to choose the most cost-effective alternative from a series of alternatives. Once most effective technologies are identified, a detailed economic evaluation will be performed in a forthcoming TM (TM 4).

TABLE 2-6
The WRRP Current Electricity, Chemical, and Sludge Disposal Costs

Item	Unit Cost
Electricity Cost, \$/kWh	0.15 ^a
Sodium Hypochlorite (12.5%), \$/gal	1.41
Citric Acid (50%), \$/gal	5.99
Sodium Bisulfite (25%), \$/gal	2.25
Sodium Hydroxide (25%), \$/gal	2.38
Sulfuric Acid (93%), \$/gal	3.75
Aqueous Ammonia (25%), \$/gal	2.97
Antisclant, \$/gal	41.2
Ferric Chloride (39-44%), \$/gal	1.63
Salt, \$/ton	65
Salt Transportation, \$/trip	731
Biosolids Disposal Cost, \$/wet ton	39.5
Labor Cost, \$/hour	60 ^b

^aElectricity unit cost of \$0.15/kiloWatt hour (kWh) was assumed to accommodate increased electricity cost before project implementation

^bGrade III level operator hourly salary including the fringe benefits

3.0 Evaluation of Treatment Technologies

3.1 Liquid Treatment Technologies for Secondary Treatment

Liquid treatment technologies for secondary treatment include:

- Trickling Filters (Baseline)
- Conventional activated sludge (CAS)
- Oxidation ditch
- Membrane bioreactor

All four technologies are proven and commonly used in wastewater treatment applications.

3.1.1 Trickling Filters

Trickling filters or biotowers are the most commonly utilized attached growth systems; and with proper design, they can produce stabilized effluent that would be conducive to Title 22 use with tertiary filtration followed with disinfection. Trickling filters are relatively simple to operate, but the trickling filter may not always produce a consistent water quality. Relatively high BOD of the wastewater makes the nitrification process complicated, requiring a separate treatment stage for ammonia removal, if needed. This can be achieved by incorporating a “solids contactor,” which is a small activated sludge basin. It also requires managed organic loading to the filters and periodic treatment for snail control. Secondary clarifiers are used for solids-liquid separation. A process schematic of a typical trickling filter/solids contact (TF/SC) system is shown in Figure 3-1.

FIGURE 3-1
Process Flow Schematic of a Trickling Filter with Solids Contactor

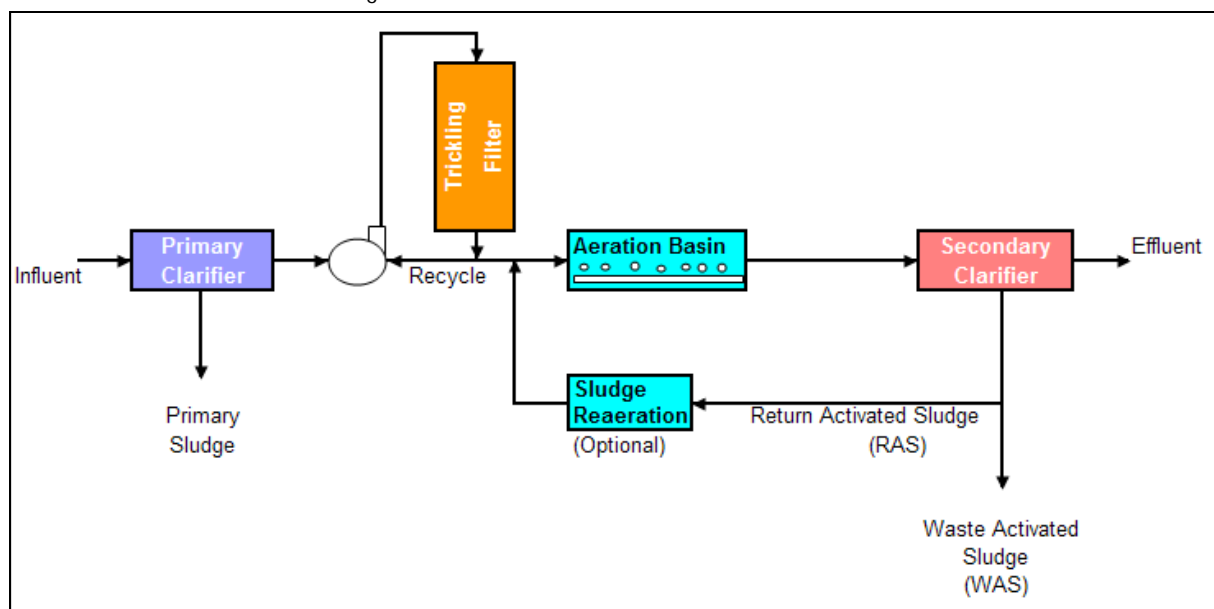

At WWRP, the existing trickling filter is shallow (only 3 feet deep) and was designed for BOD removal and does not include aeration and re-aeration basins presented in Figure 3-1.

Depending on the effluent nitrogen concentration requirements, additional facilities such as additional activated sludge tanks or biologically active filters with external carbon addition (e.g., methanol) are required to achieve denitrification and removal of nitrogen. The major advantage of trickling filters over suspended growth systems is the ability of trickling filters to handle high flow peaks and shock loadings. They are more resilient to biomass washout with biomass being retained on filter media. Trickling filter in this evaluation represents the baseline condition, and advantages and disadvantages of other treatment technologies are discussed relative to the trickling filters.

3.1.1.1 3.1.2 Conventional Activated Sludge

The CAS system is a biological treatment process that involves the conversion of organic matter and/or other constituents in wastewater to cell tissue and final products (i.e., carbon dioxide, water) by a large mass of microorganisms maintained in suspension by mixing and aeration. The microorganisms form flocculent particles that are separated from the process effluent using secondary clarifiers and subsequently returned to the front end of the aeration basin or wasted. They are typically designed to remove biochemical oxygen demand (BOD) and suspended solids and for nitrification, but can easily be modified for nitrogen and phosphorus removal. A process flow schematic of a CAS system designed to achieve BOD and nitrogen removal is presented in Figure 3-2.

FIGURE 3-2
Process Flow Schematic of a CAS for BOD and Nitrogen Removal

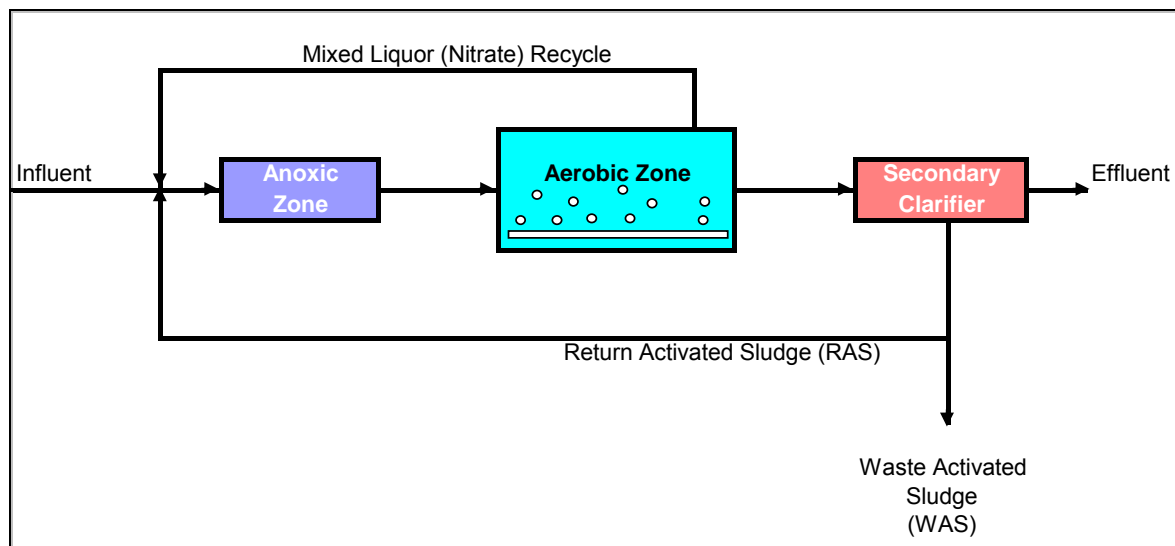

CAS is commonly used for domestic strength wastewater treatment. The level of treatment provided can be adjusted based on the oxygenation capacity provided in the treatment basins. For Title 22 recycled water production, tertiary filtration and disinfection facilities need to be included after the activated sludge treatment.

Advantages of CAS systems over trickling filters are:

- Adaptable to many operating schemes including selector design, step feed, and anoxic/aerobic processes, with flexibility to meet various treatment goals
- Depending on the configuration, can achieve low nutrient concentration levels
- Better sludge settling characteristics with lesser fine particles than trickling filter
- Provides better overall treatment than trickling filters including BOD, emerging contaminants
- Better coupled with advanced treatment technologies than trickling filter

Disadvantages of CAS systems over trickling filters are:

- Higher energy cost as result of aeration, which can be comparable when trickling filters with post-denitrification facilities are considered
- Process performance can be more susceptible to shock loads and flow peaks

3.1.2 Oxidation Ditch Activated Sludge System

The oxidation ditch consists of a ring or oval-shaped channel equipped with mechanical aeration (e.g., mixers or brush aerators). Screened wastewater enters the channel and is combined with the return activated sludge as shown in Figure 3-3. This process produces a stabilized effluent that is conducive to Title 22 use with tertiary filtration followed with disinfection.

FIGURE 3-3
Process Flow Schematic of an Oxidation Ditch Activated Sludge Systems

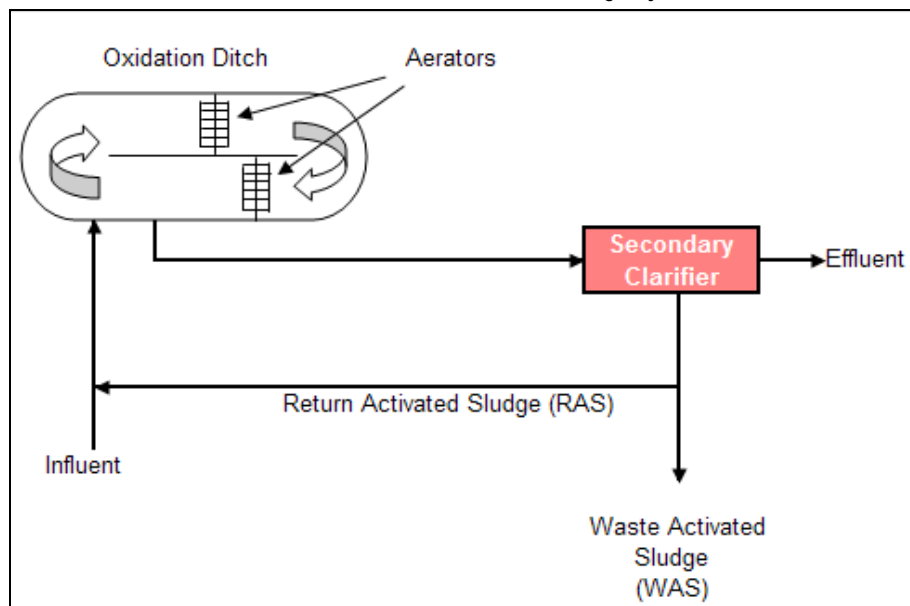

The tank configuration and mixing devices promote unidirectional channel flow. Energy used for aeration is sufficient enough to provide mixing in a system with relatively high hydraulic retention time. The mixing energy is needed to keep the solids in suspension and to create sufficient flow velocity in the channel to keep the mixed liquor moving through the reactor. As the wastewater leaves the aeration zone, dissolved oxygen (DO) concentration decreases and denitrification may occur. External or, in some cases, intra-channel clarifiers are used. The oxidation ditch is designed for and operated at relatively high SRT, which can remove slowly biodegradable organic material and reduce sludge production.

Advantages of oxidation ditch systems over trickling filters are:

- Depending on the configuration, can achieve low nutrient concentration levels
- Better sludge settling and dewatering characteristics than trickling filter
- Provides better overall treatment than trickling filters including BOD, emerging contaminants
- Better coupled with advanced treatment technologies than trickling filter
- Well stabilized sludge; lower biosolids production

Disadvantages of oxidation ditch systems over trickling filters are:

- Larger space requirement
- Possible low food to microorganism sludge bulking
- Proprietary requirement for some oxidation ditch process configurations; license fees may be required
- Requires more energy than trickling filters or CAS
- More difficult plant phasing

3.1.3 Membrane Bioreactors

MBRs combine activated sludge biological treatment with an integrated membrane filtration system to provide enhanced organics stabilization and suspended solids removal. MBR uses a low-pressure membrane filtration system (e.g., microfiltration or ultrafiltration) and eliminates the need for secondary clarifiers and tertiary filtration for solid-liquid separation. With the membrane units forming a “barrier” for separation of solids and liquids, MBR systems are designed to operate at mixed liquor suspended solids (MLSS) concentrations as high as 8,000 to 10,000 milligrams per liter (mg/L), resulting in a much smaller aeration tank volume requirement compared to CAS systems. No additional treatment units are needed other than disinfection for Title 22 water production. Elimination of secondary clarifiers and tertiary filters significantly reduces the overall footprint of the facility.

Membrane bioreactors come in several different configurations including:

- External pressure-driven membranes, manufactured commonly in a tubular configuration and are referred to as external MBRs

- Integrated submerged membranes (membranes submersed into the aeration basin)
- External submerged membranes (membranes submerged into the external membrane tank and receive mixed liquor from the aeration tank)
- External submerged rotating membranes (rotating membranes submerged into the external membrane tank and receive wastewater from the aeration tank)

Although external pressure-driven membranes have gained attention recently, the most commonly used configuration is the external submerged membranes. In external submerged systems, membranes are subjected to a vacuum that draws product water (permeate) through the membrane while retaining solids in the membrane separation tank. To clean the exterior of the membranes, air is introduced below the membranes. As the air bubbles rise to the surface, they scour the membrane surface; and solids are returned to the mixed liquor. Figure 3-4 presents a typical process schematic of an MBR system.

FIGURE 3-4
Process Flow Schematic of an MBR

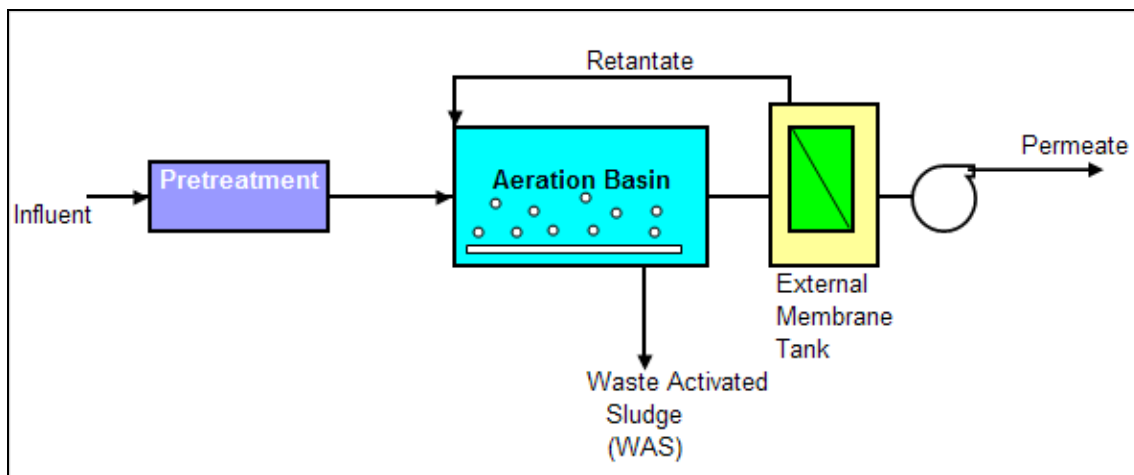

Advantages of MBR systems over trickling filters are:

- Superior effluent quality compared to trickling filters (i.e., TSS<1.0 mg/L, BOD<5 mg/L).
- MBR combines secondary treatment and tertiary filtration together and does not require additional tertiary filtration.
- Effective for removing of certain emerging contaminants.
- Reliable performance, not impacted by most influent water quality fluctuations.
- Small footprint, eliminating secondary clarifiers and tertiary filtration facilities.
- Modular design allowing staged implementation.
- Simultaneous nitrification-denitrification achievable through process control.
- Better coupled with advanced treatment technologies than trickling filter.

- Well-stabilized sludge; low biosolids production.

Disadvantages of MBR systems over TFS are:

- Higher energy requirements due to membrane operation compared to trickling filters and CAS
- Membrane fouling that can affect the ability to treat design flows if membranes are not properly maintained

Comparison of secondary treatment technology alternatives is summarized in Table 3-1.

TABLE 3-1
Comparison of Secondary Treatment Technologies

Process	Design and Performance Characteristics	Advantages	Disadvantages
Trickling Filters	Typical Organic Loading Rate – BOD Removal – 80-85 percent	Baseline	
CAS	Typical SRT – 3 to 10 days BOD Removal – 85-95 percent	Flexible operation; adaptable to many operating schemes Achieves low nutrient concentration levels Better sludge settling and dewatering characteristics Better overall treatment than TFS including BOD, emerging contaminants Better suited with advanced treatment technologies	Relatively large footprint and tankage requirements Higher energy cost Process performance more susceptible to shock loads and flow peaks
Oxidation Ditch	Typical SRT – 10 to 25 days BOD Removal – 90-98 percent	Achieve low nutrient concentration levels Better sludge settling and dewatering characteristics Better overall treatment than TFS including BOD, emerging contaminants Better suited with advanced treatment technologies Well stabilized sludge; low biosolids production	Much more complex than conventional Higher energy input than TF or CAS to obtain treatment Larger footprint More difficult to phase, especially at lower flow capacity

TABLE 3-1
Comparison of Secondary Treatment Technologies

Process	Design and Performance Characteristics	Advantages	Disadvantages
MBR	Typical SRT – 8 to 15 days BOD Removal – 90-98 percent	<p>Superior effluent quality compared to TFs (i.e., TSS<1.0 mg/L, BOD<5 mg/L)</p> <p>Effective for removing of certain emerging contaminants</p> <p>Reliable performance, not impacted by most influent water quality fluctuations.</p> <p>Small footprint; eliminates secondary clarifiers and tertiary filtration facilities</p> <p>Modular design; allows staged implementation</p> <p>Simultaneous nitrification-denitrification achievable</p> <p>Better coupled with advanced treatment technologies than trickling filter</p> <p>Well stabilized sludge; low biosolids production</p>	<p>Higher energy requirements due to membrane operation compared to TFs and other activated sludge alternatives</p> <p>Membrane fouling that can affect the ability to treat design flows if membranes are not properly maintained</p>

3.2 Tertiary Filtration Technologies

Nearly a dozen of the tertiary filtration technologies have Title 22 approval for reuse applications. The most commonly used filtration technologies in wastewater treatment include:

- Membrane Filtration
- Depth Filtration
- Surface Filtration

WWRP currently uses membrane filtration technology for treating low- and high-TDS treatment streams. These three filtration categories are further evaluated below.

3.2.1 Membrane Filtration

Microfiltration (MF) and ultrafiltration (UF) are the low-pressure membrane filtration processes (that is, typical operating pressures range from 3 to 40 pounds per square inch [psi]) that are used to remove particulate and microbial contaminants, including turbidity, *Giardia*, and *Cryptosporidium*. MF/UF technologies that are commercially available in North America for municipal reuse applications can be divided into two broad categories based on which side of the membrane the driving force for filtration is applied: (1) Pressurized (pressure applied to the feed side) or (2) Immersed or submerged (vacuum applied to the permeate side).

In both types of systems, membrane fibers are bundled in groups of several thousand and potted in a resin on both ends to form a module, with tens to hundreds of modules coupled together to form a system. With the pressurized type, the modules are housed in a pressure vessel or the vessel is integral to the module. Feedwater is pressurized and applied to the feed side of the membranes in the module. Typical operating pressures range from 3 to 40 psi depending on specific product operating conditions. Figure 3-5 shows schematic of a typical submerged membrane filtration system.

FIGURE 3-5.
Schematic of a Typical Submerged Membrane Filtration System

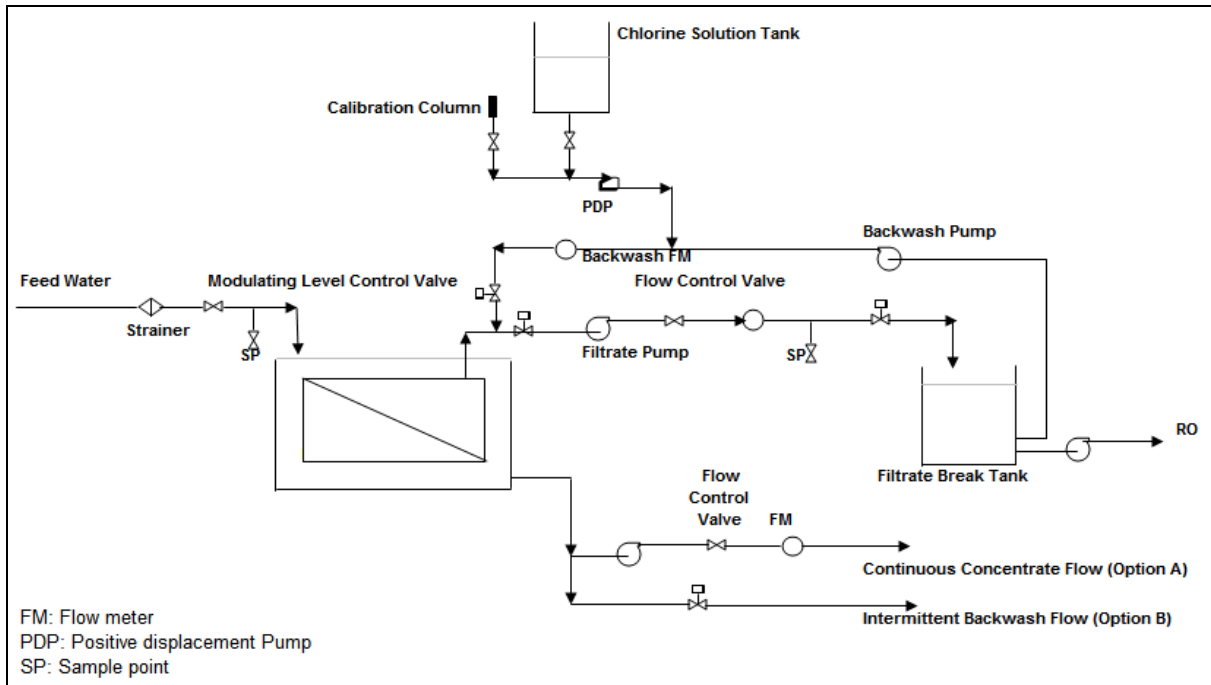

As constituents accumulate on the membranes, modules need to be backwashed or cleaned chemically to prevent membrane fouling. Although membrane filtration is an energy-intensive process, it is increasingly employed in water and wastewater treatment and very effective in removing particulate material, turbidity, and pathogens. A high degree of removal for these compounds is then achieved in a small footprint, which typically justifies the cost of energy. Depending upon cleaning intervals, membranes need to be replaced every 5 to 7 years. Although membrane replacement cost is not as high as power cost, membrane replacement costs are the key portion of the operations and maintenance (O&M) cost.

Membrane filtration, herein, reflects the baseline conditions; and the advantages and disadvantages of other technologies are presented relative to membrane filtration.

3.2.2 Depth Filtration

Depth filtration is one of the most common methods used for filtration of effluents from treatment processes, especially in water reuse applications. The four types of depth filters used most commonly for wastewater filtration are:

- Conventional down flow filters (mono, dual, and multi-media)
- Deep-bed down flow filters
- Deep-bed upflow continuous backwash filters (e.g., DynaSand)
- Traveling bridge filters

Filters that must be taken off-line periodically for backwash are classified as semi-continuous filters, whereas filters in which backwash and filtration operation occurs simultaneously are classified as continuous filters.

3.2.2.1 Conventional Down Flow Filters

Flow containing suspended matter is applied to the top of the filter bed. Single, dual, and multi-medium filter materials can be used. Sand and/or anthracite are the most common types used for reuse applications. Head loss buildup occurs as the filtration takes place, and the system must be backwashed routinely one filter cell at a time. They are semi-continuous filters and are approved for Title 22 applications by the CDPH.

3.2.2.2 Deep-bed Down Flow Filters

The deep-bed filters are similar to conventional filters with the exception that the filter medium depth and the size of filtering medium are greater than those values in conventional filters. Because of greater depth and larger medium size, more solids can be stored within the filter bed; and the filter run length can be extended. The maximum depth of filter medium depends on the ability to backwash the filter. These filters are not generally fluidized completely during backwash, thereby requiring air scour plus water for effective cleaning. They are also semi-continuous filters and are approved for Title 22 applications by CDPH.

3.2.2.3 Deep-bed Upflow Continuous Backwash Filters

Deep-bed upflow continuous backwash filters, such as the DynaSand filter, require the chemically preconditioned wastewater to be introduced from the bottom of the filter where it flows upward through a series of riser tubes and is distributed evenly into the sand bed through the open bottom of an inlet distribution hood. The water flows upward through the downward-moving sand. Clean filtrate exits from the sand bed, overflows to a weir, and is discharged from the filter. Sand and trapped solids are drawn downward at the same elevation into the suction of an airlift pipe that is in the center of the filter. Compressed air is introduced to the bottom of the airlift to uplift sand and solids containing water. It is possible to get sand blowoff in the effluent, which can impact the downstream disinfection. California DynaSand examples include Sausalito-Marín City Sanitary District and City of Corona. A picture of a DynaSand facility is presented in Figure 3-6.

FIGURE 3-6
Picture of a DynaSand Facility



3.2.2.4 Traveling Bridge Automatic Backwash Filters

The travelling bridge Automatic Backwash Filters (ABF) are continuous down flow, automatic backwash, low head, and granular medium depth filter. The filter bed is horizontally divided into long independent cells that treat the wastewater as it flows through them by gravity. A traveling bridge assembly is used to backwash each cell individually while other cells remain in service. Water used for backwashing is pumped directly from clearwell plenum up through the medium and deposited in a backwash trough. Because the backwashing is performed on an “as-needed” basis, the backwash cycle is termed semi-continuous. Traveling bridge filters have Title 22 approval. Examples of California applications include Sacramento County, Sepulveda Water Reclamation, Folsom WWTP, Victor Valley WWRP, LA City-Tillman WRP, and Shasta Lake WWTP.

Conventional down flow filtration and DynaSand have more applications than the other two depth filtration options. Therefore, this evaluation only considered conventional deep bed filters and DynaSand.

3.2.3 Surface Filtration

Surface filtration involves the removal of suspended materials by mechanical sieving by passing the liquid through a thin septum. Filter materials include cloth fabrics, woven metal fabrics, and a variety of synthetic materials. The two common types of systems used in water reuse applications with Title 22 approval are the cloth media filter and Discfilter; they are the older of the surface filtration systems currently available with Title 22 approval.

3.2.3.1 Cloth Media Filter

The Cloth Media Filter (CMF) is the trademark of AquaDisk by Aqua-Aerobic Systems. The system is typically arranged as vertical disks in concrete or fabricated steel or stainless-steel tanks. The system is outside-in fed, and is designed to backwash automatically based upon water differential while maintaining continuous filtration during backwash. Each disk is made up of six pie-shaped sections that are mounted vertically to a common center tube, which conveys filtered effluent from the tank. This vertical media orientation allows for a large amount of filter area in a very small footprint (up to 75 percent less than typical filters). The filter is completely static during filtration with the disks only rotating during the backwash process. Typical backwash is less than 2 to 3 percent, with a typical recovery time of less than 3 minutes. California applications include Hume Lake.

3.2.3.2 Disk Filtration

Disk filtration was used in the Kruger Hydrotech system and is a type of surface filtration where water enters a feed tank and flows through a series of submerged cloth media via an inside-out feed regime. The resulting filtrate is collected into a filtrate header where it flows to final discharge over an overflow weir in the effluent channel. As solids accumulate in the cloth media, resistance to flow or head loss increases. When the head loss through the cloth media reaches a predetermined set value, the disks are backwashed. Backwashing is performed routinely to clean both sides of each disk. Disks are typically cleaned two at a time while the disks rotate slowly. Full-scale applications of this technology exist in the United States (i.e., The City of Palm Coast, FL). Figure 3-7 shows a full-scale Disk Filtration Facility.

FIGURE 3-7
A Full-Scale Hydrotech Disc Filtration Facility



Comparison of tertiary filtration alternatives is summarized in Table 3-2.

TABLE 3-2
Comparison of the Tertiary Filtration Technologies

Process	Design and Performance Characteristics	Advantages	Disadvantages
Membrane Filtration	<p>Typical Design Flux- 20-35 gfd</p> <p>Driving Force: Transmembrane pressure</p> <p>Effluent TSS<1.0 mg/L</p> <p>Effluent Turbidity <0.2 NTU</p> <p>Backwash Requirement: 5-8% of the filtered flow</p>	Baseline	
Conventional Down Flow Filtration	<p>Hydraulic Loading Rate – <5 gal/sq-ft/min (Based on current Title 22 Requirements)</p> <p>Effluent TSS: 2-8 mg/L</p> <p>Effluent Turbidity: 2-5 NTU</p> <p>Driving Force: Gravity</p> <p>Backwash Requirement: 5-10% of the filtered flow</p>	<p>Much lower energy requirement than membrane filtration</p> <p>No chemical cleaning; but chemical preconditioning is required</p>	<p>Effluent quality is not as good as membrane filtration</p> <p>Performance depends on feedwater quality</p> <p>May require chemical addition for pretreatment</p> <p>Loss of filter medium is potential</p> <p>Larger footprint than membrane filtration</p>
Upflow Continuous Backwash Filtration	<p>Hydraulic Loading Rate – <5 gal/sq-ft/min (Based on current Title 22 Requirements)</p> <p>Effluent TSS<10 mg/L</p> <p>Effluent Turbidity <2-5 NTU</p> <p>Backwash Requirement: 8-12% of filtered flow</p>	<p>Less energy requirement than membrane filtration</p> <p>No chemical cleaning, but chemical preconditioning is required</p>	<p>Effluent quality is not as good as membrane filtration</p> <p>Performance depends on feedwater quality</p> <p>May require chemical addition for pretreatment</p> <p>Larger footprint than membrane filtration</p>
Surface Filtration	<p>Hydraulic Loading Rate – <6 gal/sq-ft/min</p> <p>Effluent TSS<10 mg/L</p> <p>Effluent Turbidity<2 NTU</p> <p>Driving Force: Gravity</p> <p>Backwash Requirement: 3-5% of filtered flow</p>	<p>Much lower energy requirement than membrane filtration</p> <p>Low head loss</p> <p>No chemical cleaning</p>	<p>Effluent quality is not as good as membrane filtration</p> <p>Performance depends on feedwater quality</p> <p>May require chemical addition for pretreatment</p> <p>Larger footprint than membrane filtration</p> <p>Enclosure may be required for odor control</p> <p>Relatively new technology</p>

gal/sq-ft/min: gallon(s) per square foot per minute
gfd: gallons per square foot per day

3.3 Disinfection

A medium-pressure, high-intensity, closed-vessel UV system (Aquionics Model 7500) provides disinfection at the WWRP. The existing UV system was built as part of the 2004 expansion. No major mechanical or structural deficiency was identified related to the UV system. However, due to flow fluctuations generally observed immediately after ZeeWeed® Ultrafiltration back pulses exert significant hydraulic challenges to the UV system. Existing piping arrangement to the UV system (a very short pipe from the low-TDS stream is combined with high-TDS stream with a tee) causes turbulence, which reduces the UV system efficiency. Hydraulic problems and the piping arrangement should be re-evaluated. It is expected that the existing UV system with minor modifications can provide adequate and efficient disinfection for current and future (with expansion) phases of the project. This evaluation, therefore, does not cover disinfection technology selection.

3.4 Solids Handling

Solids handling includes sludge thickening (optional), sludge stabilization, and dewatering. The WWRP is currently operated 10 hours per day and 7 days a week. Sludge handling facilities will be evaluated based on current operating scheme.

3.4.1 Sludge Thickening

Thickening of sludge prior to digestion is primarily considered for waste activated sludge (WAS) and a combination of primary and WAS thickening, although primary sludge thickening is not uncommon. The advantage of thickening is that it reduces the volume for digestion, thereby reducing digester capacity requirements. It also reduces the hydraulic load on the dewatering system. Thickening recycle streams can be returned to the liquid treatment train, and increase organic and nitrogen loading to the WWTP. Biological treatment facilities, therefore, should be designed to handle increased loading rates.

The WWRP currently does not have sludge thickening facilities. Depending upon the selected secondary treatment and sludge stabilization technologies, thickening of WAS may be required to eliminate the need for additional digesters. In this report, multi-criteria analysis will not be performed to identify the most suitable thickening technologies. On the other hand, if thickening is considered, two thickening alternatives will be sized and further developed.

A number of technologies is available for thickening, including dissolved air flotation thickeners (DAFTs), gravity belt thickeners (GBT), centrifuges, gravity thickeners, and rotary drum thickeners. The GBT, centrifuge, and rotary drum thickeners can produce a high solids sludge (over 6 percent), which typically cannot be achieved in DAFTs or gravity thickeners. Gravity thickeners were not considered as their performance is typically not any better than DAFT thickeners, and would not likely result in better than 5 percent sludge that can be produced by the primary clarifiers. Gravity thickeners also have a much larger footprint than the other technologies. The potential technologies include DAFTs, GBTs, thickening centrifuges, and rotary drum thickeners.

3.4.1.1 Dissolved Air Flotation Thickeners

DAFT concentrates solids as a result of the attachment of microscopic air bubbles to suspended solids, reducing their specific gravity to less than that of water. The attached particles then float to the surface of the thickener tank for removal by a skimming mechanism. DAFT thickening generally is not used for primary solids or attached growth solids because gravity settling for these types of solids is more economical. On the other hand, DAFTs are a relatively simple technology and can be used for WAS thickening. However, their thickened sludge solids concentration is well below those achieved by GBTs, centrifuges, and rotary drum thickeners. They also typically require a larger footprint. Figure 3-8 shows a typical rectangular DAFT.

FIGURE 3-8

Picture of a Typical Rectangular DAFT



3.4.1.2 Gravity Belt Thickeners

GBTs may be used for thickening WAS, primary sludge, or combined sludge, and can achieve solids concentrations of 6 to 9 percent. Sludge is flocculated with polymers, and the released water is drained by gravity through a rolling filter belt. GBTs are similar in operation to the top deck of the dewatering belt presses. They have relatively low power requirements. As gravity belts are not enclosed, additional ventilation is required. A continuous supply of wash water is also required, similar to belt presses, which increases the recycle flow from these units compared to centrifuges. A 3-meter gravity belt typically has similar hydraulic loading rates, but lower solids loading rates compared to a mid-size centrifuge. The number of units and footprint required as compared with centrifuges will therefore vary depending on whether the solids loading rate or hydraulic loading rate is constraining. Figure 3-9 shows a typical GBT.

FIGURE 3-9
Picture of a Typical GBT



3.4.1.3 Thickening Centrifuges

Thickening centrifuges are similar to dewatering centrifuges, operated at different loading rates and weir levels. Centrifuges may be used for thickening WAS and primary sludge, producing sludge with thickness ranging from 6 to 12 percent. Centrifuges are enclosed and therefore require less ventilation for odor control. They also require less wash water than GBTs. However, they do have higher power requirements than other options. Although centrifuge operation may be automated more easily than GBTs, requiring less operator attention during operation, the maintenance requirements on centrifuges are typically higher, due to high rotational speed and sophistication of the equipment. Figure 3-10 shows a typical thickening centrifuge.

FIGURE 3-10
Picture of a Typical Thickening Centrifuge



3.4.1.4 Rotary Drum Thickeners

A rotary drum or rotary screen thickener functions like a gravity belt thickener allowing free water to drain through a porous media while solids are retained on the media. Rotary drum thickeners (RDTs) are often used as a pre-thickening step with belt filter press dewatering. They are well suited for the thickening of high-fiber sludges such as those in the pulp and paper industry and also for thickening either raw or digested biosolids that contain a significant primary solids fraction. Their success with municipal WAS is variable and depends on solids characteristics. Polymer requirements are a concern because of shear potential in the rotating drum. The thickener uses a rotating drum with wedge wires, perforations, stainless-steel fabric, polyester fabric, or a combination of stainless-steel and polyester fabric as the porous media. The drum either is equipped with a center shaft mounted on a steel frame or is mounted on four wheels supporting its outer perimeter. Conditioned solids enter the drum, and filtrate drains through the screen openings. Solids are conveyed along the drum by a continuous internal screw or diverted angle flights and exit through a discharge chute. Washwater is used to flush the inside and outside of the drum cleaning the screen openings of solids.

As a general guide, sludge with 0.5 to 3 percent can be thickened to 5 to 15 percent dry solids. It is economical to operate with low horsepower and water consumption. Figure 3-11 shows a typical RDT.

FIGURE 3-11
Picture of a Typical RDT



3.4.2 Sludge Stabilization Technologies

Waste sludge from primary and secondary clarifiers is currently digested in a single-stage mesophilic anaerobic digester. Although WWRP has two anaerobic digesters, the second (secondary) digester is designed and used for sludge storage and decanting purposes. Having a single anaerobic digester reduces plant reliability and operational flexibility. The digested sludge is dewatered by the sludge drying beds prior to hauling offsite at a composting facility. The LCSD plans to continue the services at the same composting site. However, biosolids regulations have become more stringent in California; and some of the future biosolids disposal options may require Class A biosolids. Class A is not necessary for composting.

A regional biosolids plan, which considered the 11 biosolids-producing wastewater treatment plants in Santa Barbara County, was developed and summarized in *Strategic Countywide Biosolids Master Plan* (CH2M HILL, 2003). The projected total biosolids production in the entire plan area was 7,135 dry tons for the Year 2022, with 550 dry tons per year currently contributed by the LCSD WWRP. Given the regional nature of the plan, biosolids markets ranging from agricultural to construction materials production, land rehabilitation, and energy production were considered. Composting and rotary-drum drying were identified as the preferred processing technologies. The final selection of the biosolids management program elements was recommended to be conducted once the site availability, agency participation, and other coordination considerations were completed. To allow flexibility for LCSD to participate in future regional biosolids management programs, it is recommended that technologies that support increased solids stabilization and onsite energy recovery be considered. There are several approaches that can achieve these sludge stabilization goals:

- Single-Phase Mesophilic Anaerobic Digestion (baseline)
- Single-Phase Thermophilic Anaerobic Digestion
- Two-Phase Anaerobic/ Aerobic Digestion
- Acid-Gas Phase Digestion
- Cambi Process
- Cannibal Process

Each of these options is a variation of mesophilic anaerobic digestion and is described briefly below. Table 3-3 compares the different approaches and summarizes the advantages and disadvantages associated with each option.

3.4.2.1 Single-Phase Mesophilic Anaerobic Digestion

In conventional mesophilic anaerobic digestion, sludge is heated to between 35 degrees Celsius (°C) and 37°C and insulated for heat retention for a hydraulic retention time of approximately 20 days. The hydraulic retention time (HRT) for this process can vary based on the tank size and shape. Tank contents are mixed using hydraulic mixing, mechanical mixing, or gas mixing and can generally achieve 50 to 55 percent volatile solids (VS) reduction when fed a blend of primary and secondary sludge. Biogas is generated at 15 to 16 cubic feet per pound (ft³/lb) VS destroyed, and contains 63 to 68 percent methane. The digesters are fed in parallel, with a secondary digester or digested sludge storage tank receiving digested sludge for buffer storage prior to downstream dewatering. Because of its simplicity, mesophilic anaerobic digestion is the most commonly applied sludge digestion process and has a relatively low power requirement. However, this process does require a larger footprint than other alternatives.

3.4.2.2 Single-Phase Thermophilic Anaerobic Digestion

The main purpose of thermophilic digestion (optimum operating temperature of 53 to 55°C) is to improve digestion rates and provide better pathogen kills. Improved digestion rates can reduce the digestion volume requirements and allow the operation of plants at higher loading rates than mesophilic digestion (WEF, MOP 8, 1998). Thermophilic digestion is more difficult to operate and requires more attention to temperature and pH control due to sensitivity of methanogenic organisms especially growing on thermophilic temperatures.

Therefore, much tighter control is required to avoid process inhibition and upsets. Thermophilic operation also requires higher energy for heating.

3.4.2.3 Two-Phased Anaerobic/-Aerobic Digestion

Recent research has shown that it possible to achieve up to 65 to 70 percent waste solids reduction using anaerobic/aerobic digestion sequencing. This could serve as a very cost-effective solids management alternative for LCSD, while maximizing methane generation and reducing the ammonia load to the secondary treatment system. This technology consists of incorporation of an aerobic phase (3 to 5 days HRT) digestion step following the anaerobic digestion (about 15 days HRT). By separating the two modes of digestion, biogas recovery is not diminished, while further volatile solids reduction is achieved in the second phase. This could be implemented in the existing tankage of the LCSD WWRP. Similar to conventional mesophilic digestion, the digester contents are mixed using hydraulic mixing, mechanical mixing, or gas mixing, and can generally achieve 50 to 55 percent VS reduction in the first phase when fed a blend of primary and secondary sludge, with biogas being generated at 15 to 16 ft³/lb VS destroyed. Depending on the solids retention time in the second phase digester, an additional 10 to 15 percent VS destruction can be achieved.

3.4.2.4 Acid-Gas Phase Anaerobic Digestion

In this process, sludge is digested in two phases. The first phase (acid phase) is mesophilic or thermophilic, and is operated at a relatively short HRT (2 to 3 days). The second phase (gas phase) is generally mesophilic and is operated at a longer HRT (12 to 15 days). Overall, the HRT employed is shorter than conventional mesophilic digestion; however, more heat is required for the thermophilic phase than heating to mesophilic temperatures. The energy required to raise the temperature of the inlet sludge thus results in higher operation costs than conventional mesophilic digestion. As with conventional mesophilic digesters, various shapes and mixing systems can be used. Enhanced degradability is achieved in the two-stage system, with VS destruction rates that are 5 to 15 percent higher than conventional digestion and similar to those achieved in acid-gas digestion. Biogas characteristics are slightly different if thermophilic temperatures are used in the first stage; higher moisture contents are common.

The majority of full-scale, two-phase digestion systems are either mesophilic-mesophilic or thermophilic-mesophilic, although an acid-gas digestion system can be configured as:

- Mesophilic - mesophilic
- Mesophilic - thermophilic
- Thermophilic - mesophilic
- Thermophilic - thermophilic

The major drawbacks of acid-gas phase digestion are associated with complexity of the operation and significant odor generation in acid phase. Total biogas generation can be greater in the acid-gas digester; however, the gas generated in the acid phase is typically wasted because of very poor energy value. The flow schematic of acid-gas phased digestion is shown in Figure 3-12.

FIGURE 3-12
Flow Schematic of an Acid-Gas Phase Digestion

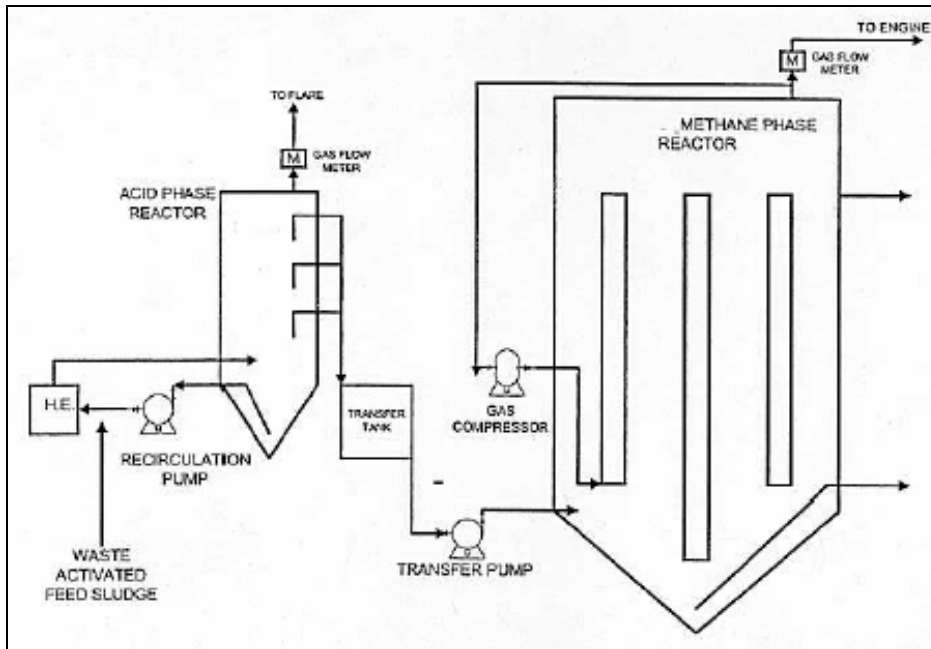

3.4.2.5 Cambi Process

The Cambi Process involves prethickening of the sludge to a relatively high concentration (12 to 14 percent) and then treating this thickened sludge in a high-pressure and high-temperature unit to hydrolyze complex organics. After pretreatment, the sludge is digested normally as in conventional mesophilic anaerobic digestion. Hydrolyzation reduces the sludge concentration to about 10 percent, which can be handled by conventional mixing systems due to the lower viscosity achieved in the hydrolyzation end product. Typically, the digestion process is sized for an HRT of 12 to 15 days. The digesters are 30 to 35 percent of the size of conventional digesters. The smaller size is achieved because of the higher concentration of the feed and the shorter HRTs employed to obtain stabilization. Generally, the Cambi Process achieves a VS reduction of 60 to 75 percent. This leads to higher gas production. In addition, Class A sludge is generated. The process diagram of the Cambi process is presented in Figure 3-13.

FIGURE 3-13
Process Flow Schematic of a CAMBI Process

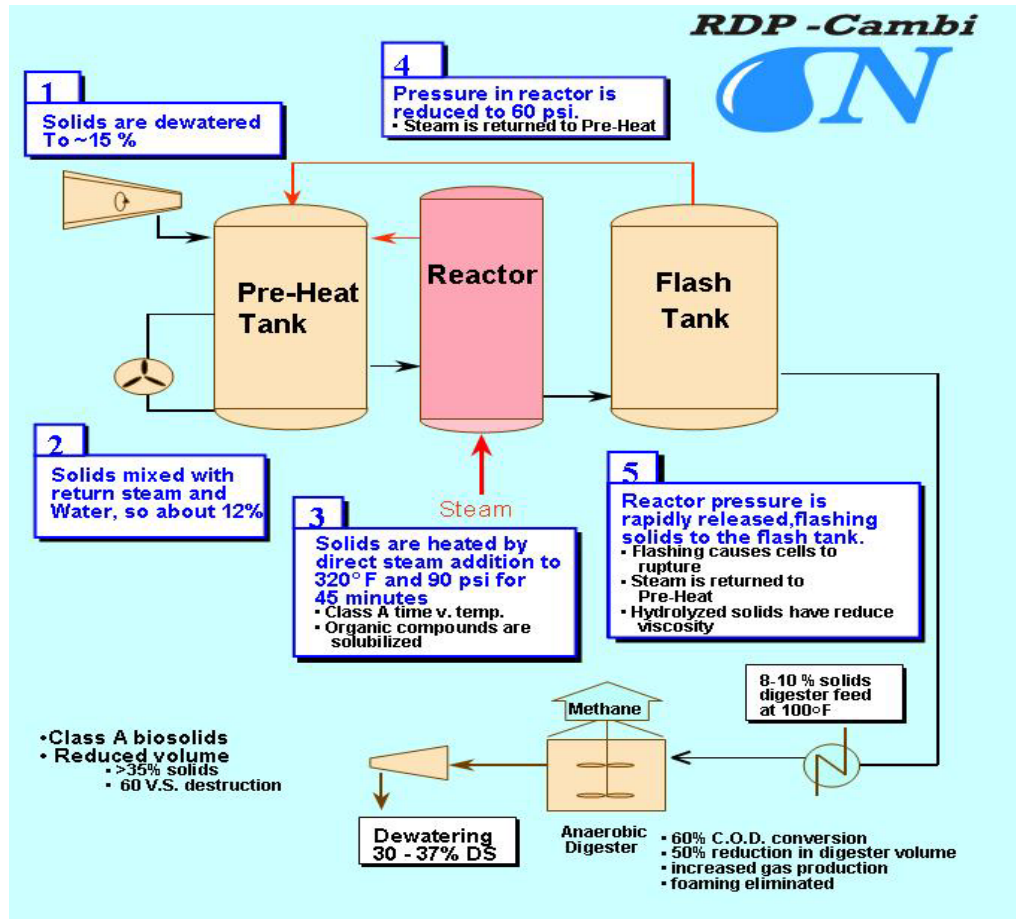

3.4.2.6 Cannibal Process

Cannibal™ is a patented biological process supplied by Siemens. It targets to reduce biosolids wasting. In this process, a portion of the return sludge is pumped to a sidestream bioreactor, or the "Interchange Reactor" where the mixed liquor is converted from an aerobic-dominant population to a facultative-dominant population. Grit and other inert materials are removed from the process through the use of a patented solids separation module (SSM) operated on the return sludge line. Through close control of the operation, aerobic bacteria are selectively destroyed in this sidestream reactor while enabling the low-yield, facultative bacteria to break down and utilize the organic material. This is achieved by using a patented control system that monitors the oxidation reduction potential (ORP)/pH and maintains mixing and aeration. Mixed liquor from the bioreactor is not "wasted" from the plant, as would occur in a typical digester. The mixed liquor is recycled back to the main treatment process where the facultative bacteria, in turn, are out-competed by the aerobic bacteria and subsequently broken down in the alternating environments of the aerobic treatment process and the sidestream bioreactor. The process flow schematic of Cannibal process is shown in Figure 3-14.

FIGURE 3-14
Process Flow Schematic of CANNIBAL Process

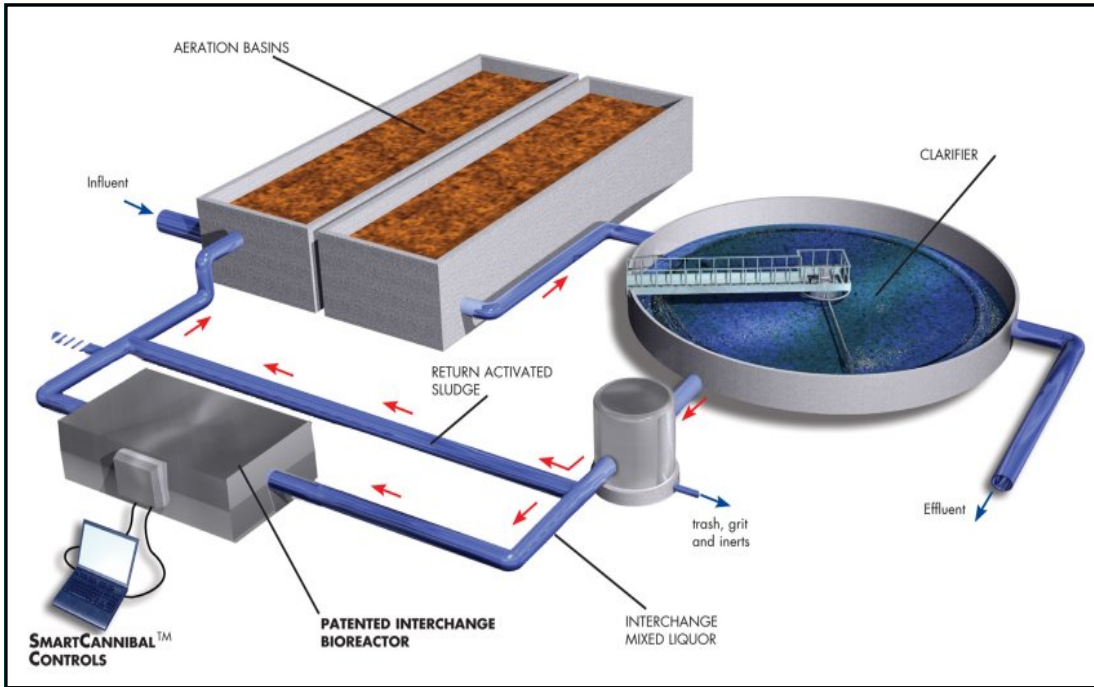

Comparison of sludge stabilization alternatives is summarized in Table 3-3.

TABLE 3-3
Representative Sludge Stabilization Technologies

Process	Performance Characteristics	Advantages	Disadvantages
Single-Phase Mesophilic Anaerobic Digestion (Conventional)	Typical HRT – 20 to 25 days VS destruction – 45 to 55 percent		Baseline
Single-Phase Thermophilic Anaerobic Digestion	Typical HRT – 20 to 25 days Typical VS destruction – 50 to 60 percent	Potentially higher VS destruction and gas production at lower HRTs Higher solids loading rates than mesophilic digestion, which opens up additional capacity Potentially meets Class A requirement (if operated in batch mode) Proven technology	More complex operation than conventional Higher energy requirements Process performance is very sensitive Increased odor (H ₂ S and mercaptan) and siloxane due to thermophilic operation Ammonia and organic concentrations increase proportional to increased VS reduction

TABLE 3-3
Representative Sludge Stabilization Technologies

Process	Performance Characteristics	Advantages	Disadvantages
Two-Phase Anaerobic/Aerobic Digestion	Typical HRT – 18 to 22 days VS destruction – 65 to 70 percent	Similar footprint as conventional digestion with sludge storage Potentially higher VS destruction and increased gas production than single-phase mesophilic digestion Lower ammonia and organics in the recycle flows	Aeration energy added in the second step Similar to single-phase anaerobic digestion
Acid-Gas Phase Digestion	Typical HRT – 14 to 20 days VS destruction – up to 65 percent	Potentially higher VS destruction and gas production at lower HRTs if operated well Higher solids loading rates than mesophilic digestion, which opens up additional capacity Potentially meets Class A requirement (if operated in batch mode or in series)	Much more complex than conventional Requires prethickening to high TS concentration Relatively little experience Complex operation Process performance is very sensitive especially with thermophilic operation Difficult to adapt to small plants Acid phase reduces the gas quality and elevates H ₂ S with added odor issues mainly related to VFA generation Ammonia and organic concentrations increase proportional to increased VS reductions
Cambi Process	HRT – 15 to 18 days VS destruction – 60 to 75 percent	Much smaller footprint than conventional Greater VS destruction and increased gas production Achieves Class A Digested sludge has better dewatering characteristics	Much more complex operation than conventional Requires prethickening to high TSS concentration Higher input energy to obtain pretreatment Relatively little experience Sole-source product supply
Cannibal Process	SRT >60 days VS destruction – 70 to 75 percent	No routine biological wasting due to very low sludge yield Eliminates sludge digestion	Complex operation than conventional Higher aeration requirements Sole-source and patented product supply Relatively little experience Eliminates gas production and energy recovery Higher carbon footprint than conventional Longer startup period is generally needed

3.4.3 Sludge Dewatering Technologies

The digested sludge at WWRP is dewatered by sludge drying beds. Dried biosolids are piled onsite for annual removal. Existing drying beds are not lined and can potentially contaminate groundwater. The average dry cake content of the biosolids after dewatering is about 23 percent (*Strategic Countywide Biosolids Master Plan*; CH2M HILL, 2003). The biosolids hauling cost overall has significantly increased over last 5 years. Although the LCSD has an existing contract with the local composting facility, an efficient sludge dewatering system could be beneficial for reducing the sludge quantity, providing flexibility for future and reduced hauling costs.

Depending upon sludge stabilization technology selection, routine dewatering may not be needed (i.e., Cannibal process). In this study, multi-criteria analysis will not be performed to identify the most suitable dewatering technologies; rather, two potential dewatering alternatives will be identified and further developed once sludge stabilization technologies are identified.

The sludge dewatering alternatives include:

- Sludge Drying Beds (baseline)
- Belt Filter Press
- Centrifuge Dewatering
- Rotary Press

3.4.3.1 Sludge Drying Beds

Sludge drying beds are the existing drying alternative and are a method of air drying that refers to dewatering that removes moisture by natural expiration, evaporation, or induced drainage. Air drying processes are less complex, easier to operate, and may be more energy efficient than mechanical systems. However, air drying requires larger land; and some require much more labor for cake removal. Furthermore, winter weather and rainfall heavily influence the efficiency of air drying systems. Air drying is usually considered for treatment facilities with design flows less than 2 mgd, and that are located in warm, dry weather areas. Existing drying beds at the WWRP site are unlined, which necessitate liner addition to control the potential for groundwater contamination. Similar to the mechanical dewatering processes, the higher the proportion of secondary biosolids, the more difficult the biosolids are to dry, and the higher the chemical consumption will be. The process is broadly affected by the volume of water in the biosolids (i.e., the higher the solids concentration, the shorter the drainage and evaporation time to reach a given moisture level).

Solar drying is an alternative to the conventional drying beds. The technology employs thermal energy from the sun to evaporate a large portion of the water content of the biosolids. Solar drying beds have been successfully used in both Europe and the United States, and are cost efficient for 1.0- to 10-mgd plants because they require a minimal amount of energy, labor, and maintenance. In typical installations, biosolids are spread over a large covered area, similar to a greenhouse, while the sun evaporates the water. During drying, the biosolids are turned and mixed. Ventilation is an important factor to continually remove moisture-laden air from the surface of the biosolids and replace it with fresh dry air. Both batch and continuous operation is possible. The process schematic of a version of this

process marketed by Huber Technologies is shown in Figure 3-15. The use of heat recovery loop from wastewater as shown is optional.

FIGURE 3-15
Process Schematic of Solar (Greenhouse) Drying Process (Huber Technology shown)

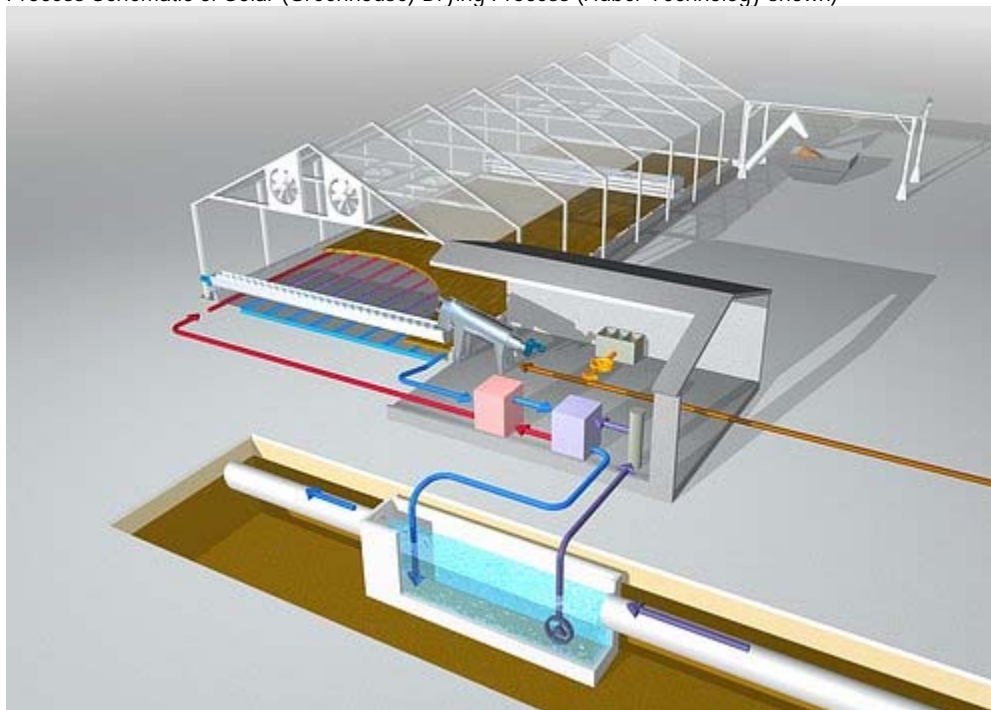

3.4.3.2 Belt Filter Presses

The operation of a belt filter press (BFP) is based upon the principles of filtration and comprises a gravity drainage zone, where the feed is thickened; a low-pressure zone; and a high-pressure zone. In the gravity zone, most of the free water from the flocculation process drains through a porous belt. This is followed by the low-pressure zone where the thickened feed is subjected to low pressure to further remove water and form a viscous biosolids matrix. In the high-pressure section, the matrix is sandwiched between porous belts passing through a series of decreasing diameter rollers. The roller arrangement progressively increases the pressure, filtering more water from the matrix. There are numerous design differences between the various manufacturers, mostly varying in the relative sizes of the different zones.

BFPs are quiet and have low power consumption. Mechanical failure is easy to identify; and typically many parts can be located relatively easily, making presses relatively inexpensive for mechanics of average skills to repair or overhaul onsite. However, BFPs are open to air and therefore more odorous, require significant operator attention, and do not produce cake with solids content typically greater than 20 percent. They require significant quantities of wash water addition, which need to be returned to the main plant for treatment as part of the filtrate. Figure 3-16 presents a picture of a typical BFP.

FIGURE 3-16
Picture of a Typical BFP

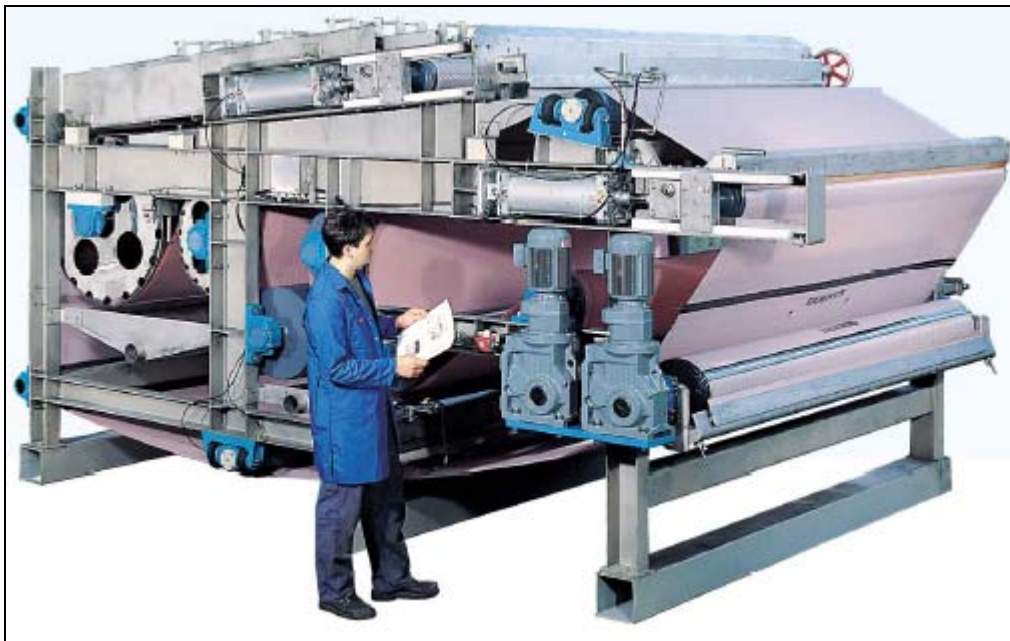

3.4.3.3 Centrifuge Dewatering

Centrifugal dewatering uses the force developed by the rotational movement of a bowl to separate the solids from the liquids. Biosolids are pumped through a central pipe into a rotating solid-wall bowl. The solids remain on the inside walls of the bowl due to the centrifugal force. The heavier particles move to the outside, while the lighter liquid remains pooled in the center of the bowl. A screw conveyor inside the centrifuge moves the dewatered cake out of the unit.

Centrifuges may offer certain benefits over BFPs. Centrifuges typically produce a drier cake than belt presses. They also have higher capacities than BFPs, so fewer units would be required. Unlike BFPs, centrifuges do not require continuous belt washing. A small amount of wash water is required during shutdown operations each day, as well as a small water flow added to the centrate to prevent potential struvite formation. The reduced wash water requirements result in less sidestream flow when compared with belt filter presses. Additionally, centrifuges are enclosed, which reduces odor control needs.

Centrifuges have higher energy requirements than belt filter presses. As with other dewatering technologies, polymer addition to the digested biosolids prior to dewatering is required. Typically, more polymer is required on a dry-ton basis for centrifuges than for BFPs. Also, the building design needs to accommodate vibration from the centrifuges. Centrifuges used in dewatering are very similar to centrifuge thickener shown in Figure 3-10.

3.4.3.4 Rotary Press

The rotary press uses two dewatering zones: filtration, where the free water is eliminated, and pressure, where the biosolids is compressed to reduce moisture content. Solids are moved through the unit by a wheel, which generates pressure through friction with the

channel walls. The wheel rotates at a maximum speed of three rotations per minute (rpm). Two circular screens on either side of the unit screen the filtrate from the dewatered biosolids, with an average capture of 95 percent. At the outlet, there is a back-pressure plate that can be adjusted to provide the desired percent solids. Typically, feed pressure is between 1 to 8 pounds per square inch (psi), and discharge pressure is up to 70 psi. The rotary press is available in one, two, four, and six channel units. Potential advantages of the rotary press are the low-power requirements compared with centrifuges. The process is enclosed, which provides advantages over belt presses for odor control. Wash water requirements are also low, with the unit being washed only when the operation stops. As with other dewatering technologies, polymer needs to be added to the influent biosolids.

In a side-by-side study conducted at the Los Angeles County Sanitation Districts, the cake solids from the rotary press ranged from 10 to 21 percent cake solids depending on operating conditions. For the same digested sludge, a BFP produced 17 percent cake solids and centrifuges produced 25 percent cake solids. A typical rotary press is presented in Figure 3-17.

FIGURE 3-17
Picture of a Typical Rotary Press

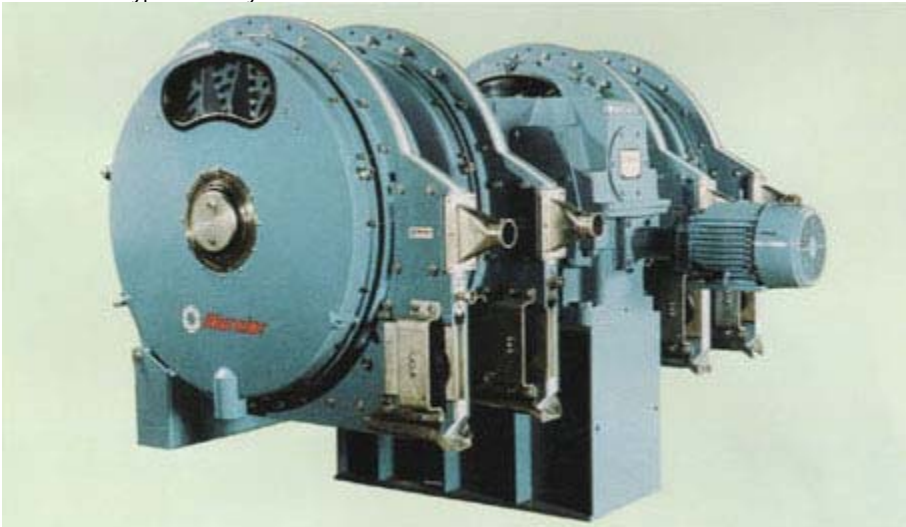

3.5 Energy Considerations

Energy considerations for the WWRP consist of the following three elements:

1. Energy efficiency: use of higher efficiency equipment or operational approaches to reduce energy consumption
2. Energy recovery: use of technologies that lead to increasing electricity recovery, such as methane generation from biogas and biomass amendment with co-digestion
3. Renewable energy: site considerations that reserve site space for incorporating renewable energy technologies, such as wind and solar power

Efficient use of energy for treatment functions will be considered for technology evaluation and site planning. The ability to maximize primary treatment performance can reduce the load that needs to be treated in the secondary treatment and also optimize bioenergy recovery. For example, high-efficiency aeration blowers will be considered, where applicable, in place of centrifugal units. Digester mixing to optimize performance will consider high-efficiency mixers that are also low in energy input, optimizing the efficiency of the overall digestion system.

The bioenergy recovery from the wastewater and/or the treatment waste solids will be sized based on the type of the treatment alternative selected. Maximizing the energy potential of primary sludge, as well as co-digestion, will be considered to optimize the energy recovery at the WWRP site. Digestion capacity considerations will involve typical yields from biosolids and co-digestion based on experience for this study. Facilities needed to handle and utilize the bioenergy will be included for the selected alternative. These facilities can include gas recovery, handling and treatment units to produce power in addition to existing gas handling, and microturbine units. The recovered energy will be considered for onsite utilization to offset treatment and other facility demands.

Since the evaluation and comparison of renewable energy options (i.e., solar, wind) are out of the project scope, evaluation of renewable energy options will not be included in this TM. As a part of developing wastewater treatment alternatives, space availability for solar and/or wind energy recovery will be considered. A brief discussion will also be included to show if the renewable technology alternatives can meet the future power requirement of the plant. The WWRP site as shown in Figure 2-1 is a total of 57 acres (the improved plant area is 22 acres but 57 acres land is available for use around plant site). The District owns a total of 596 acres including farm and pastureland.

4.0 Short Listing of Treatment Alternatives via Non-Monetary Criteria

A number of treatment alternatives are applicable to LCSD. Because detailed evaluation of each technology would be time-consuming and costly, only two technologies were selected for further evaluation. The short-listed technologies were chosen using a multi-criteria analysis, wherein weightings were applied to a pre-determined set of evaluation criteria to develop benefit scores for each alternative.

4.1 Non-Monetary Criteria

For non-monetary criteria evaluation, a multi-criteria analysis methodology is employed to develop clear and defensible benefit scores for screening of treatment options. With multi-criteria analysis, a set of criteria was first developed for use in ranking the appropriateness of each alternative in satisfying the project objectives. Secondly, each criterion was assigned a weighting factor (importance factor) that reflects its relative importance. The weighting factors range from 1 (least important relative to other criteria) to 10 (most important relative to other criteria), allowing calculation of a “weighted” criterion score based on how important the criterion is for the project in the overall decision-making process. Candidate criteria were first developed by CH2M HILL and reviewed, modified, and endorsed by LCSD. The non-monetary criteria were developed for secondary treatment, tertiary filtration, and sludge stabilization treatment alternatives. Table 4-1 summarizes the secondary treatment and tertiary filtration evaluation criteria, their description, and respective weight resulting from this collaborative process. Table 4-2 presents evaluation criteria, criteria definition, and weighting (importance) factors for sludge stabilization alternatives.

TABLE 4-1
Non-Monetary Criteria, Criteria Definition, and Assigned Weighting Factors for the Secondary Treatment and Tertiary Filtration Options

Non-Monetary Criteria	Weighting Factor	Definition/Measures
Reliable and Consistent Operation	10	Ability of the alternative to reliably treat wastewater regardless of influent wastewater quality conditions.
Ease of Operation and Maintenance	9	Extent of the time required to operate and maintain the treatment facilities. Degree of operation provided.
Ease of Phasing	8	Ability of the alternative to be phased out.
Impact on Facility Staffing	8	Extent of staff required to operate and maintain the alternative.
Compatibility with Potential Future Regulations	7	Ability of the alternative to meet stringent future regulations (i.e., potential inclusions of pharmaceuticals, personal care products, endocrine disrupting compounds in future regulations).

TABLE 4-1
Non-Monetary Criteria, Criteria Definition, and Assigned Weighting Factors for the Secondary Treatment and Tertiary Filtration Options

Non-Monetary Criteria	Weighting Factor	Definition/Measures
Chemical Usage	7	Type and number of chemical storage and feed facilities and hazardous nature of chemicals to be stored.
Overall Aesthetics	7	Appearance of the facilities associated with the alternative and its visual/auditory/olfactory impact on project locations (height, noise, odor) and impacts of these effects on plant operators.
Ease of Incorporating into the Existing Facility and Constructability	6	Degree of design and construction necessary to integrate alternative into existing plant, difficulty/time required for such integration, and extent of impact on on-going operations.
Compatibility with Existing Disinfection and TDS Removal Technologies	6	Ability of the alternative to meet existing disinfection and TDS removal requirements.
Green House Emissions and Carbon Footprint	6	Ability of process to reduce greenhouse gas emissions and carbon footprint.
Impacts on Plant Hydraulics	6	Need for flow equalization or pumping.
Ability to Maximize Use of Existing Infrastructure and Assets	5	Ability of the alternative to use existing infrastructure.
Facility Footprint and Site Space Requirement	3	Ability of the alternative to fit within the available area.

TABLE 4-2
Solids Treatment Qualitative Criteria and Associated Definition/Measures

Non-Monetary Criteria	Weighting Factor	Definition/Measures
Reliable and Consistent Operation	10	Reliable performance regardless of influent wastewater quality conditions.
Ease of Operation and Maintenance	9	Extent of the time required to operate and maintain the treatment facilities. Degree of operation provided.
Impact of Recycle Streams on Plant Loading and Side Stream Treatment Requirement	9	Degree of treatment need and impact of organic and nitrogen loading on plant performance when centrate/ filtrate streams are returned to the head of the WWTP.
Ease of Phasing	8	Ability of the alternative to be built in phases.
VS Reduction, Gas Production, and Energy Recovery	8	Ability of the alternative to increase VS reduction and gas production compared to single-phase mesophilic digestion.
Impact on Facility Staffing	8	Extent of staff time required to operate and maintain the alternative.

TABLE 4-2
Solids Treatment Qualitative Criteria and Associated Definition/Measures

Non-Monetary Criteria	Weighting Factor	Definition/Measures
Impact on Sludge Dewaterability	7	Relative ease of sludge dewaterability and product quality.
Compatibility with Current and Future Biosolids Regulations	7	Ability of the alternative to meet current and anticipated biosolids regulations.
Chemical Usage	7	Type and number of chemical storage and feed facilities and hazardous nature of chemicals to be stored.
Overall Aesthetics	7	Appearance of the facilities associated with the alternative and its visual/auditory/olfactory impact on project locations (height, noise, odor) and impacts of these effects on plant operators.
Solids Disposal and Hauling	7	Ability of the alternative to minimize solids disposal and hauling needs.
Ease of Incorporating into the Existing Facility and Constructability	6	Degree of design and construction necessary to integrate alternative into existing plant, difficulty/time required for such integration, and extent of impact on ongoing operations.
Open up Addition Capacity for Future Digestion and Co-digestion	6	Ability of the alternative to enhance digestion rates and offer extra capacity for future digestion and co-digestion.
Green House Emissions and Carbon Footprint	6	Ability of process to reduce greenhouse gas emissions, or have a relatively lower greenhouse gas emissions and carbon footprint.
Impacts on Plant Hydraulics	6	Need for flow equalization or pumping.
Ability to Maximize Use of Existing Infrastructure and Assets	5	Ability of the alternative to use existing infrastructure.
Facility Footprint and Site Space Requirement	3	Ability of the alternative to fit within the available area.

Following the development criteria and weighting factors, individual scores were given for each criterion for a given treatment alternative. This process was repeated for each criterion and each treatment technology to calculate benefit scores for the treatment alternatives. The resultant scores were presented in Appendix A for secondary treatment, tertiary filtration, and sludge stabilization options. "Simple Multi-Attribute Rating Technique" (SMART) software was used to calculate the total benefit scores for each technology. The SMART software provides a decision process that is independent of the number of alternatives because each alternative is considered separately.

4.2 Benefit Scores for Treatment Alternatives

4.2.1 Benefit Scores for Secondary Treatment Alternatives

Figure 4-1 illustrates the benefit scores for four secondary treatment alternatives. Each color bar in Figure 4-1 refers to individual criterion score, and the sum of the color bars reflects the total benefit scores for the alternatives. According to Figure 4-1, MBR has the highest total benefit score (7.61) among the four alternatives. Reliable and consistent operation, ability to phase, being compatible with potential future regulations and existing disinfection, and TDS removal technologies gave MBR the competitive edge over other alternatives and resulted in the highest benefit scores. In addition, MBR combines biological treatment, settling, and filtration options and eliminates the need for solids separation and filtration. CAS received the second highest total benefit score (6.92). Even though CAS cannot produce very high-quality water compared to MBR, CAS is a well proven and most commonly used biological treatment technology that satisfies water quality objectives while effectively utilizing existing infrastructure. The oxidation ditch (5.76) requires a larger footprint than any alternatives, and it is difficult to phase. Although trickling filters are easy to operate and receive the highest scores on greenhouse gas (GHG) emission criterion, their performance cannot match with other technologies, are not compatible with potential future regulations, and are not well suited with existing TDS and disinfection removal technologies. Two secondary treatment technologies that will be further evaluated, therefore, include MBR and CAS.

FIGURE 4-1
Benefit Evaluation for Secondary Treatment Alternatives

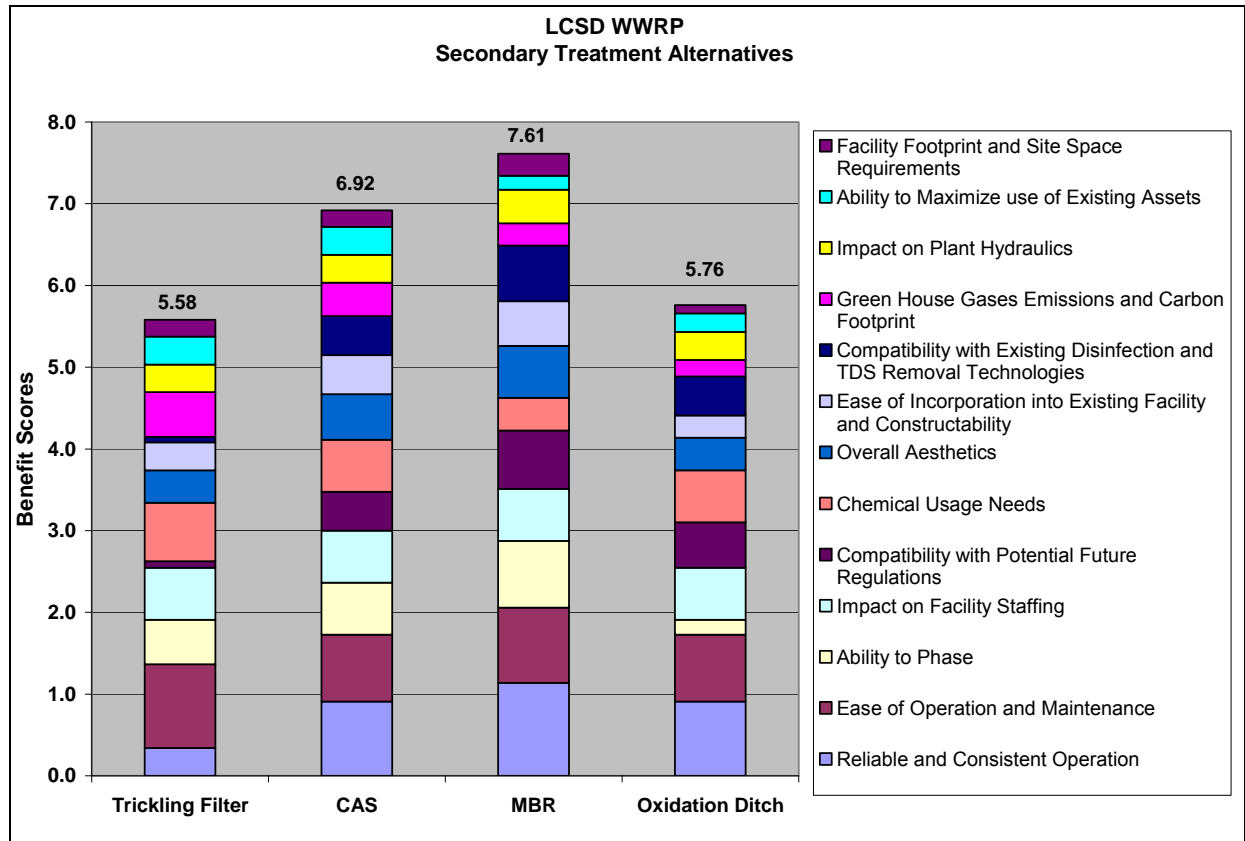

4.2.2 Benefit Scores for Tertiary Filtration Alternatives

The benefit scores for four tertiary filtration alternatives are presented in Figure 4-2. This figure indicates that membrane filtration and cloth media filtration are the most suitable technologies based on selected criteria scoring. Reliable and consistent operation, ability to phase, being compatible with potential future regulations and existing disinfection, and TDS removal technologies gave membrane filtration the highest benefit scores (8.39) among four candidate alternatives. Cloth filtration (5.28) is relatively easy to operate, requires minimal chemical addition under normal operating conditions, and is a low energy solution that reduces GHG emission. Its performance depends significantly on the upstream process performance, and can result in quality variability if hydraulic or solids loading increases or fluctuates. Chemical pretreatment was observed to be ineffective at other installations under poor feed quality conditions. Dual media (4.27) and DynaSand (4.45) filtration have been widely applied for tertiary filtration with a good track record depending on the upstream process performance and downstream disinfection method. These technologies are not well suited with future regulations and existing disinfection (especially UV) and TDS removal technologies. For this reasons, they received lower scores than membrane and cloth media filtration.

Based on the benefit scores, membrane filtration and cloth media filtration will be further evaluated.

4.2.3 Benefit Scores for Sludge Stabilization Alternatives

The benefit scores for six sludge stabilization alternatives are presented in Figure 4-3. According to Figure 4-3, conventional single-phase anaerobic digestion (currently used technology at WWRP) is the most suitable alternative among six alternatives and based on the benefit scores (7.12). It received highest score because it is:

- It is reliable and more prone to process upsets compared to its thermophilic counterparts.
- It is easy to operate (no additional training and staffing is needed).
- It maximizes use of existing infrastructure.
- It is easy to phase.

While the benefit scores distinctly identify the first place, benefit scores were very close for two-phase digestion (6.69) and Cannibal process (6.14). Because the digestion technologies and Cannibal have high merit scores and viable benefits that could offer cost-effective biosolids management options for LCSD, they need to be further evaluated.

Unlike any other alternatives, Cannibal process does not require further digestion or sludge stabilization because sludge stabilization is achieved in the Cannibal reactors. With the exception of infrequent purges and daily screened material, no wasting is performed in the Cannibal process, which can significantly reduce the sludge hauling and disposal costs. However, it does not support biogas generation. Therefore, the monetary benefits gained in sludge disposal need to be weighed against the bioenergy recovery potential of the digestion options.

FIGURE 4-2
Benefit Evaluation for Tertiary Filtration Alternatives

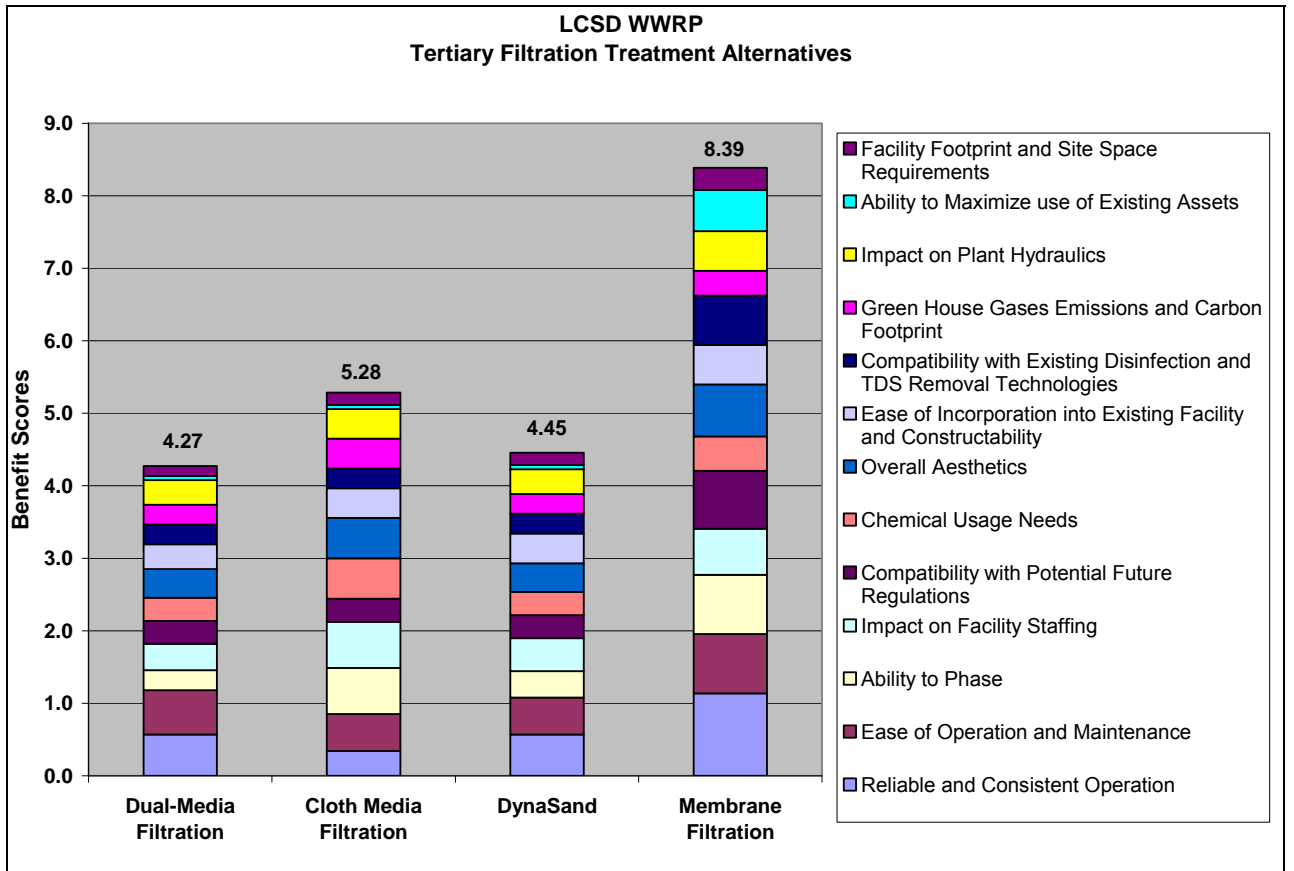
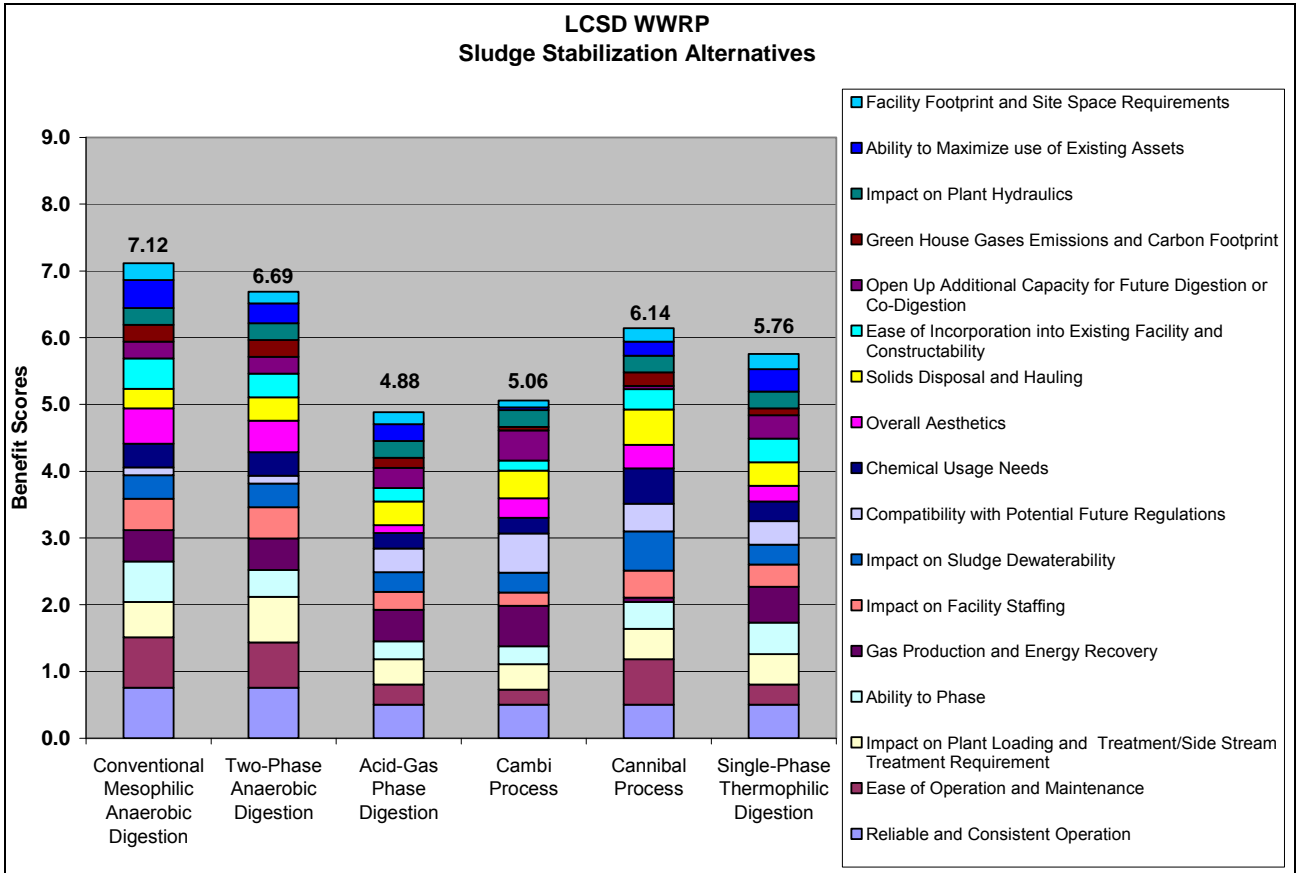

FIGURE 4-3
Benefit Evaluation for Sludge Stabilization Alternatives



5.0 Short-Listed Treatment Alternatives

The following treatment alternatives will be further evaluated in terms of benefit scores and cost-basis-based life cycle costs over a 20-year project period.

Secondary treatment alternatives:

- CAS
- MBR

Tertiary treatment alternatives:

- Membrane filtration (only applicable to CAS)
- Cloth media filtration (only applicable to CAS)

Sludge stabilization alternatives:

- Single-phase mesophilic digestion
- Two-phase anaerobic/ aerobic digestion
- Cannibal

Pro2D, CH2M HILL's whole plant process simulation model, will be used to establish preliminary sizing for the unit treatment processes, ancillary equipment, plant liquid and solids mass balances, and recycle flow management for the short-listed alternatives. The findings developed using Pro2D models will be applied to CPES, a CH2M HILL cost estimating tool to establish capital and operations and maintenance cost estimates for the short-listed alternatives. Life cycle costs will be developed using a 6 percent discount rate and 20-year project period. Ultimately, the alternatives will be ranked based on benefit-to-cost ratios, to identify the treatment alternatives that could provide the highest benefit for unit project cost.

Appendix A

LCSO WWRP

Technology Alternatives Multicriteria Evaluation - Secondary Treatment Alternatives

Evaluation Criteria	Weighting Factor	Scores for Liquid Treatment Alternatives				Adjusted Weights	Benefit Scores			
		Trickling Filter	CAS	MBR	Oxidation Ditch		Trickling Filter	CAS	MBR	Oxidation Ditch
Reliable and Consistent Operation	10	3	8	10	8	0.114	0.341	0.909	1.136	0.909
Ease of Operation and Maintenance	9	10	8	9	8	0.102	1.023	0.818	0.920	0.818
Ability to Phase	8	6	7	9	2	0.091	0.545	0.636	0.818	0.182
Impact on Facility Staffing	8	7	7	7	7	0.091	0.636	0.636	0.636	0.636
Compatibility with Potential Future Regulations	7	1	6	9	7	0.080	0.080	0.477	0.716	0.557
Chemical Usage Needs	7	9	8	5	8	0.080	0.716	0.636	0.398	0.636
Overall Aesthetics	7	5	7	8	5	0.080	0.398	0.557	0.636	0.398
Ease of Incorporation into Existing Facility and Constructability	6	5	7	8	4	0.068	0.341	0.477	0.545	0.273
Compatibility with Existing Disinfection and TDS Removal Technologies	6	1	7	10	7	0.068	0.068	0.477	0.682	0.477
Greenhouse Gases Emissions and Carbon Footprint	6	8	6	4	3	0.068	0.545	0.409	0.273	0.205
Impact on Plant Hydraulics	6	5	5	6	5	0.068	0.341	0.341	0.409	0.341
Ability to Maximize use of Existing Assets	5	6	6	3	4	0.057	0.341	0.341	0.170	0.227
Facility Footprint and Site Space Requirements	3	6	6	8	3	0.034	0.205	0.205	0.273	0.102
SUM		72	88	96	71	1.00	5.58	6.92	7.61	5.76

LCSD WWRP Technology Alternatives Multicriteria Evaluation - Tertiary Filtration Alternatives											
	Evaluation Criteria	Weighting Factor	Scores for Filtration Alternatives				Adjusted Weights	Benefit Scores			
			Dual-Media Filtration	Cloth Media Filtration	DynaSand	Membrane Filtration		Dual-Media Filtration	Cloth Media Filtration	DynaSand	Membrane Filtration
1	Reliable and Consistent Operation	10	5	3	5	10	0.114	0.568	0.341	0.568	1.136
2	Ease of Operation and Maintenance	9	6	5	5	8	0.102	0.614	0.511	0.511	0.818
3	Ability to Phase	8	3	7	4	9	0.091	0.273	0.636	0.364	0.818
4	Impact on Facility Staffing	8	4	7	5	7	0.091	0.364	0.636	0.455	0.636
5	Compatibility with Potential Future Regulations	7	4	4	4	10	0.080	0.318	0.318	0.318	0.795
6	Chemical Usage Needs	7	4	7	4	6	0.080	0.318	0.557	0.318	0.477
7	Overall Aesthetics	7	5	7	5	9	0.080	0.398	0.557	0.398	0.716
8	Ease of Incorporation into Existing Facility and Constructability	6	5	6	6	8	0.068	0.341	0.409	0.409	0.545
9	Compatibility with Existing Disinfection and TDS Removal Technologies	6	4	4	4	10	0.068	0.273	0.273	0.273	0.682
10	Greenhouse Gases Emissions and Carbon Footprint	6	4	6	4	5	0.068	0.273	0.409	0.273	0.341
11	Impact on Plant Hydraulics	6	5	6	5	8	0.068	0.341	0.409	0.341	0.545
12	Ability to Maximize use of Existing Assets	5	1	1	1	10	0.057	0.057	0.057	0.057	0.568
13	Facility Footprint and Site Space Requirements	3	4	5	5	9	0.034	0.136	0.170	0.170	0.307
	SUM		54	68	57	109	1.00	4.27	5.28	4.45	8.39

LCSD WWRP Technology Alternatives Multicriteria Evaluation - Sludge Stabilization Alternatives															
Evaluation Criteria	Weighting Factor	Scores for Solids Treatment Alternatives						Adjusted Weights	Benefit Scores						
		Conventional Mesophilic Anaerobic Digestion	Two-Phase Anaerobic/ Digestion	Acid-Gas Phase Digestion	Cambi Process	Cannibal™ Process	Single-Phase Thermophilic Digestion		Conventional Mesophilic Anaerobic Digestion	Two-Phase Anaerobic Digestion	Acid-Gas Phase Digestion	Cambi Process	Cannibal Process	Single-Phase Thermophilic Digestion	
1	Reliable and Consistent Operation	10	9	9	6	6	6	6	0.084	0.756	0.756	0.504	0.504	0.504	0.504
2	Ease of Operation and Maintenance	9	10	9	4	3	9	4	0.076	0.756	0.681	0.303	0.227	0.681	0.303
3	Impact on Plant Loading and Treatment/Side Stream Treatment Requirement	9	7	9	5	5	6	6	0.076	0.529	0.681	0.378	0.378	0.454	0.454
4	Ability to Phase	8	9	6	4	4	6	7	0.067	0.605	0.403	0.269	0.269	0.403	0.471
5	Gas Production and Energy Recovery	8	7	7	7	9	1	8	0.067	0.471	0.471	0.471	0.605	0.067	0.538
6	Impact on Facility Staffing	8	7	7	4	3	6	5	0.067	0.471	0.471	0.269	0.202	0.403	0.336
7	Impact on Sludge Dewaterability	7	6	6	5	5	10	5	0.059	0.353	0.353	0.294	0.294	0.588	0.294
8	Compatibility with Potential Future Regulations	7	2	2	6	10	7	6	0.059	0.118	0.118	0.353	0.588	0.412	0.353
9	Chemical Usage Needs	7	6	6	4	4	9	5	0.059	0.353	0.353	0.235	0.235	0.529	0.294
10	Overall Aesthetics	7	9	8	2	5	6	4	0.059	0.529	0.471	0.118	0.294	0.353	0.235
11	Solids Disposal and Hauling	7	5	6	6	7	9	6	0.059	0.294	0.353	0.353	0.412	0.529	0.353
12	Ease of Incorporation into Existing Facility and Constructability	6	9	7	4	3	6	7	0.050	0.454	0.353	0.202	0.151	0.303	0.353
13	Open Up Additional Capacity for Future Digestion or Co-Digestion	6	5	5	6	9	1	7	0.050	0.252	0.252	0.303	0.454	0.050	0.353
14	Greenhouse Gases Emissions and Carbon Footprint	6	5	5	3	1	4	2	0.050	0.252	0.252	0.151	0.050	0.202	0.101
15	Impact on Plant Hydraulics	6	5	5	5	5	5	5	0.050	0.252	0.252	0.252	0.252	0.252	0.252
16	Ability to Maximize use of Existing Assets	5	10	7	6	1	5	8	0.042	0.420	0.294	0.252	0.042	0.210	0.336
17	Facility Footprint and Site Space Requirements	3	10	7	7	4	8	9	0.025	0.252	0.176	0.176	0.101	0.202	0.227
	SUM	119	121	111	84	84	104	100	1.00	7.12	6.69	4.88	5.06	6.14	5.76

Identifying Most Suitable Treatment Options for Laguna County Sanitation District Wastewater Reclamation Plant

PREPARED FOR: Laguna County Sanitation District
 PREPARED BY: CH2M HILL
 DATE: December 25, 2009

Contents

Background and Objective ii

1.0 Evaluation of Treatment Options..... 1-1

 1.1 Treatment Alternatives..... 1-1

 1.2 Key Assumptions and Design Criteria..... 1-3

2.0 Upgrade/Modification and Expansion Needs for the Treatment Options 2-1

3.0 Cost Estimate and Benefit-to-Cost Ratios for Treatment Options 3-1

 3.1 Recommendations 3-13

Tables

1-1 Design Criteria for CAS and MBR Treatment Options

2-1 Upgrade, Modification, and Expansion Needs for CAS and MBR Options for Ultimate Capacity

3-1 Cost Estimate Summary for CAS Alternatives

3-2 Cost Estimate Summary for MBR Options

3-3 LCCs, Total Benefit Scores, B/C Ratios, and Alternative Rankings for Treatment Alternatives

3-4 Sensitivity Analysis Scenarios for Alternative 1 and 6

Figures

3-1 LCCs, B/C Ratios for Treatment Alternatives

3-2 CAS Site Layout

3-3 MBR Site Layout

Appendices

A Cost Estimate Details for CAS

B Cost Estimate Details for MBR

Background and Objective

Technical Memorandum (TM) 3 screened and short-listed the following treatment alternatives based on non-monetary benefit scores. These alternatives included:

Secondary treatment alternatives:

- Conventional Activated Sludge (CAS)
- Membrane Bioreactor (MBR)

Tertiary filtration alternatives:

- Membrane filtration
- Cloth media filtration

Sludge stabilization alternatives:

- Single-phase mesophilic anaerobic digestion
- Two-phase anaerobic/aerobic digestion
- Cannibal process

In this TM (TM 4), these alternatives are further evaluated in terms of 20-year life cycle costs (LCC) to identify the treatment alternative(s) that exhibit the highest benefit-to-cost (B/C) ratio(s). Pro2D, CH2M HILL's whole plant process simulation model, was used to establish preliminary sizing for the unit treatment processes, ancillary equipment, plant liquid and solids mass balances, and recycle flow management for the short-listed alternatives. The findings developed using Pro2D models were applied to CPES, a CH2M HILL cost estimating tool, to establish the capital and operations and maintenance (O&M) cost estimates for the short-listed alternatives. LCCs for each treatment alternative were developed using a 6 percent discount rate and 20-year project period. Replacement of parts and consumables over the project life were also considered in the cost models to make a fair comparison among the alternatives. Finally, B/C ratios were developed for the alternatives to identify the most suitable treatment alternative for the project. The objective of this TM is to summarize the evaluation findings.

1.0 Evaluation of Treatment Options

The treatment alternatives were developed for two major treatment options. The two major treatment options include the CAS system and the MBR.

1.1 Treatment Alternatives

In the CAS¹ option, a brand new CAS facility replaces the existing trickling filter. Filtration and sludge stabilization and handling options are coupled with the CAS to generate following eight CAS alternatives:

- Alternative 1: CAS + membrane filtration + sludge thickening (waste activated sludge [WAS] only) + single phase anaerobic digestion + sludge dewatering using sludge drying beds
- Alternative 2: CAS + cloth media filtration + sludge thickening (WAS only) + single-phase anaerobic digestion + sludge dewatering using sludge drying beds
- Alternative 3: CAS + membrane filtration + sludge thickening (WAS only) + single-phase anaerobic digestion + sludge dewatering using Belt Filter Press (BFP)
- Alternative 4: CAS + membrane filtration + sludge thickening (WAS only) + single-phase anaerobic digestion + sludge dewatering using solar drier
- Alternative 5: CAS + cloth media filtration + sludge thickening (WAS only) + single-phase anaerobic digestion + sludge dewatering using solar drier
- Alternative 6: CAS + membrane filtration + sludge thickening (WAS only) + two-phase digestion (anaerobic-aerobic) + sludge dewatering using sludge drying beds
- Alternative 7: CAS + membrane filtration + Cannibal + Infrequent sludge dewatering using a rental BFP
- Alternative 8: CAS + membrane filtration + Cannibal + Infrequent sludge dewatering using a portion of the existing sludge drying bed area

Notice that 18 CAS alternatives can be generated using a combination of filtration, sludge stabilization, and dewatering technologies. These 18 alternatives were screened, but only 8 CAS alternatives (Alternative 1 through 8) are presented in this TM for the reader to easily track the potential alternatives. The presented alternatives covered diverse treatment options and included the most cost-effective treatment alternative. All 18 CAS alternatives will be presented in a scheduled workshop and included in the Appendix of the final report.

In the MBR² option, a brand new MBR facility replaces the existing trickling filter. Because MBR couples biological treatment with solids separation and filtration, there is no need for

¹ Unless otherwise mentioned, the CAS facility includes primary settling tanks, activated sludge tanks with fine-bubble diffuse aeration system, aeration blowers, secondary clarifiers, and RAS/WAS pump station.

additional secondary clarification and tertiary filtration facilities. Sludge stabilization and handling options previously presented are coupled with the MBR to generate the following MBR alternatives:

- Alternative 9: MBR + sludge thickening (WAS only) + single-phase anaerobic digestion + sludge dewatering using sludge drying beds
- Alternative 10: MBR + sludge thickening (WAS only) + single-phase anaerobic digestion + sludge dewatering using BFP
- Alternative 11: MBR + sludge thickening (WAS only) + single-phase anaerobic digestion + sludge dewatering using solar drier
- Alternative 12: MBR + Cannibal (no primary settling) + sludge dewatering using a rental BFP
- Alternative 13: MBR + Cannibal (no primary settling) + sludge dewatering using a portion of the existing sludge drying bed area
- Alternative 14: MBR + Cannibal with primary settling+ single-phase anaerobic digestion + sludge dewatering using a portion of the existing sludge drying bed area
- Alternative 15: MBR + Cannibal with primary settling+ single-phase anaerobic digestion + sludge dewatering using a rental BFP
- Alternative 16: MBR + sludge thickening (WAS only) + two-phase digestion + sludge dewatering using sludge drying beds

Notice that 18 MBR alternatives can be generated using a combination of primary settling, no primary settling, sludge stabilization, and dewatering technologies. These 18 alternatives were screened, but only 8 MBR alternatives (Alternative 9 through 16) are presented in this TM for the reader to easily track the potential alternatives. The presented alternatives covered diverse treatment options and included the most cost-effective treatment alternative. All 18 alternatives will be presented in the scheduled workshop and included in the Appendix of the final report.

In each alternative, if applicable, the capacity of the existing infrastructure and unit processes (i.e., primary settling basins, primary sludge and scum pumps, tertiary ultrafiltration and related auxiliary facilities, anaerobic digesters) were evaluated. Future expansion considered using these facilities, if applicable, to minimize the capital investment cost of the project.

² Unless otherwise mentioned, the MBR facility includes primary settling tanks, activated sludge tanks with fine-bubble diffuse aeration system, aeration blowers, membrane tanks, air scour system for membrane cleaning, CIP system, and RAS/WAS pump station.

1.2 Key Assumptions and Design Criteria

The sizing of facility and capital and O&M costs developed in this TM are based on the following key assumptions:

- Facility sizing and the cost estimate are based on flows and loads presented in Table 1.1.
- Although the headworks upgrade has no impact on the process selection, the capital costs for headworks are included, which will be used in the financial planning modeling. The capital costs are estimated for replacing existing headworks (i.e., adding a new Huber step screen and replacing the existing grit chambers with the new system) and building a new headworks.
- Biological treatment for the CAS and MBR options is designed for biological oxygen demand (BOD) removal only considering that biological nutrient removal is not required at Laguna County Sanitation District (LCSD). However, a solids retention time (SRT) of no less than 5 days will be provided to allow biodegradation of slowly biodegradable compounds (i.e., polysaccharides). Recent full-scale experiences indicated that membrane filtration or cloth media filtration facilities that are coupled with the short SRT CAS facilities are subject to significant fouling due to the presence of very fine particulate and organic foulants as a result of short SRT operation. An anoxic zone will also be included, and it will act as an anoxic selector by minimizing sludge bulking and improving sludge settling and filterability.
- Key unit processes and process equipment will handle wastewater flows and loads with one large unit out of service.
- Existing and future clarifiers will not be covered for odor control.
- All unused existing infrastructure will be abandoned in place.
- Currently, disinfected water used on demand is stored in the storage reservoir when reuse water demand is low. However, such practice causes bacterial re-growth in the storage reservoir. Depending on the reuse application, re-disinfection of water may be necessary. LCSD is considering options to avoid bacterial re-growth and re-disinfection of water. One option is to store disinfected water in the existing storage reservoir and provide re-disinfection if reuse water is needed for higher uses rather than beef cattle grazing. Because options to minimize bacterial re-growth in the storage reservoir do not have any influence on the process selection herein, these options will be further discussed in a forthcoming TM (TM 5, Project Implementation TM).
- Currently, LCSD is building a 1-million-gallon (MG) recycled water tank at the plant site (design by Wallace Group, 2009). Three 1-MG future tanks are also planned, and space will be reserved for these future facilities.
- Sludge drying beds will be lined to prevent groundwater contamination.
- Digester upgrades will include converting the secondary digester to a primary digester by installing a new sludge mixer and heating system. Currently, LCSD is replacing the existing steel dome of primary digester with a concrete dome and is planning to provide

pipe stub-outs for a future gas storage sphere. The digester upgrade also includes a high-pressure storage sphere system to store the produced gas.

- LCSD currently operates a gas handling and co-generation facility at the wastewater reclamation plant (WWRP). LCSD is getting a low return (\$30,000/year) from this system and is planning to terminate co-generation operation next year. With the proposed digester upgrades, gas productions and savings are expected to increase. In this evaluation, a volatile solids (VS) reduction of 55 percent and biogas yield of 15 cubic feet per pound (ft³/lb) VS destroyed will be assumed in biogas estimations.
- Currently, dewatered biosolids are hauled offsite for composting by a private company. For purposes of this evaluation, it will be assumed that the future dewatered solids will be handled in the same fashion.
- LCSD WWRP is currently treating high- and low-total-dissolved-solids (TDS) streams separately. It is assumed that LCSD will continue to provide separate treatment in the future.
- The existing high-TDS MBR treatment train at the WWRP is designed to treat up to 500,000-gallon-per-day (gpd) flow. LCSD is planning to divert a high-TDS flow of approximately 62,000 gpd from the city of Santa Maria to the water reclamation plant (WRP) in the future when as the new headworks facility is built. This high-TDS flow is based on flow and TDS measurements taken from Semco (Waller) flow metering station manhole on December 17 and 18, 2009. Because these measurements are based on limited data, the future MBR train capacity was assumed to treat 600,000 gpd (current capacity plus 100,000-gpd additional flow).
- Effluent limits will remain the same.

Table 1-1 presents design criteria used in this evaluation. These design criteria were used in process and facilities sizing, as well as in solids mass balance for sizing solids handling and treatment facilities. For proprietary technologies (i.e., Cannibal, solar drier), the design criteria were obtained from the equipment suppliers.

TABLE 1-1
Design Criteria for CAS and MBR Treatment Options

Process	CAS Design Criteria	MBR Design Criteria
Influent Flows and Loads		
Average Total Annual Flow, mgd	5.0	5.0
Maximum Monthly Total Flow Rate (1.1 times the average total annual flow), mgd	5.5	5.5
Peak Wet Weather Flow, mgd	12.0	12.0
Influent BOD ₅ , mg/L	232	232
Influent TSS, mg/L	210	210
Influent TKN, mg/L	41	41
Influent Ammonia-N, mg/L	29	29
Influent VSS/TSS Ratio	0.8	0.8

TABLE 1-1
Design Criteria for CAS and MBR Treatment Options

Process	CAS Design Criteria	MBR Design Criteria
Headworks		
Peak Flow with 20% Safety Factor, mgd	14.4	14.4
Maximum Approach Velocity to Screening Channel, ft/s	5.0	5.0
Screen Openings, mm	3.0	3.0
Average Screening Production, ft ³ /mg	5.0	5.0
Peak Screening Production, ft ³ /mg	25	25
Primary Settling		
Design TSS Removal at Average Flows and Loads, %	65	65
Design BOD Removal at Average Flows and Loads, %	25	25
Hydraulic Loading Rate (All settling tanks in service), gpm/ft ²	<1,000	<1,000
Hydraulic Loading Rate (One settling tank out of service), gpm/ft ²	<2,000	<2,000
Primary Sludge Concentration, %	4	4
Biological Treatment (Activated Sludge System)		
Total SRT, days	8	10
Average Water Temperature, °C	20	20
Minimum Water Temperature, °C	16	16
Maximum Water Temperature, °C	25	25
Activated Sludge Basin Tank Side Water Depth, ft	20	20
% Anoxic Volume (% of the Total Activated Sludge Basin Volume), %	15	15
Activated Sludge Basin Length to Width Ratio	8 (minimum)	8 (minimum)
Maximum MLSS Concentration (One basin out of service), mg/L	3,200	7,100
Minimum Dissolved Oxygen Concentration in Aeration Basin, mg/L	1.5	1.5
Standard Oxygen Transfer Efficiency, %	35	35
Blower Safety Factor on Peak Diurnal Loads	1.3	1.3
Average Air Rate per Diffuser, scfm/diffuser	1.5	1.5
Maximum Air Rate per Diffuser, scfm/diffuser	3.0	3.0
Secondary Clarification		
Hydraulic Loading Rate (All clarifiers in service), gpm/ft ²	<600	NA
Hydraulic Loading Rate (One clarifier out of service), gpm/ft ²	<750	NA
Solids Loading Rate (All clarifiers in service), lb/d/ft ²	<20	NA
Solids Loading Rate (One clarifier out of service), lb/d/ft ²	<25	NA

TABLE 1-1
Design Criteria for CAS and MBR Treatment Options

Process	CAS Design Criteria	MBR Design Criteria
Membrane Tanks		
Instantaneous Flux (all tanks in service), gfd	NA	13.1
Instantaneous Flux (one tank out of service), gfd	NA	17.0
Membrane Tank Depth, ft	NA	12.0
Maximum MLSS Concentration in Membrane Tanks (one membrane tank out of service), mg/L	NA	10,000
Maximum MLSS Concentration in Membrane Tanks (one aeration basin out of service), mg/L	NA	12,000
Minimum Percent Available Space for Additional Membrane Installation, %	NA	15
Tertiary Membrane Filtration Options		
1. Membrane Filtration (Based on GE-Zenon Submerged Membrane System)		
Average Feedwater TSS, mg/L	≤10	NA
Maximum Feedwater TSS, mg/L	25	NA
Instantaneous Flux (all tanks in service), gfd	20	NA
Maximum Transmembrane Pressure (TMP), psi	9	NA
Minimum Backwash Frequency, min	60	NA
Minimum Chemically Enhanced Backwash Frequency, days	2	NA
Minimum CIP Frequency, days	30	NA
Minimum Water Recovery, %	90	NA
Effluent (Filtrate) Quality Requirement per CDPH Title 22 Recycled Water Criteria for Membrane Treatment		
Turbidity, NTU	Less than 0.1, 95% of the time Less than 0.2, 100% of the time	Less than 0.1, 95% of the time Less than 0.2, 100% of the time
2. Cloth Media Filtration System (Based on AquaAerobics Cloth Media System)		
Average Feedwater TSS, mg/L	≤10	NA
Maximum Feedwater TSS, mg/L	25	NA
Maximum Hydraulic Loading Rate, gpm/ft ²	6.0	NA
Backwash Requirement, % of the Filtrate	3.0-5.0	NA
Effluent (Filtrate) Quality Requirement per CDPH Title 22 Recycled Water Criteria for Membrane Treatment		
Turbidity, NTU	≤ 2, daily average ≤ 5, 95% of the time ≤ 10, 100% of the time	NA NA NA

TABLE 1-1
Design Criteria for CAS and MBR Treatment Options

Process	CAS Design Criteria	MBR Design Criteria
UV Disinfection		
Minimum Feed Water UV Transmittance at 254 nm, %	65 (with membrane filtration)	65
	55 (with cloth media filtration)	
Design UV Dose, mJ/sq-cm	80 (with membrane filtration)	80
	100 (with cloth media filtration)	
Type	Medium Pressure	Medium Pressure
Disinfected Water Quality Requirement per Title 22 Recycled Water Regulations		
Seven-day total coliform median value, MPN/100 mL	≤2.2	≤2.2
Maximum total coliform value in a single sample over any 30-day period, MPN/100 mL	≤23	≤23
RAS/WAS Pump Station		
RAS Pumps		
RAS Flow (% of the total flow rate), %	100	400
Total Dynamic Head, ft	25	25
Operation	24/7	24/7
WAS Pumps		
Total Dynamic Head, ft	30	30
Operation	7 days a week, 10 hrs per day	7 days a week, 10 hrs per day
Sludge Thickening Options for WAS		
1. Gravity Belt Thickening		
Average Feed Suspended Solids Concentration, mg/L	4,600	8,000
Maximum Hydraulic Loading Rate, gal/meter-min	200	200
Maximum Solids Loading Rate, lb/meter-hour	1,200	1,200
Belt Width, meter	1.5	1.5
Minimum Percent Solids Capture, %	93	93
Dry Polymer per Dry Solids Dewatered, lb/ton	16	16
Thickened Sludge Concentration, %	6	6
Operation	7 days a week, 10 hrs per day	7 days a week, 10 hrs per day
2. Rotary Drum Thickening		
Average Feed Suspended Solids Concentration, mg/L	4,600	8,000
Hydraulic Loading Rate, gal/min per unit	<200	<200
Solids Loading Rate, lb/h per unit	<550	<550

TABLE 1-1
Design Criteria for CAS and MBR Treatment Options

Process	CAS Design Criteria	MBR Design Criteria
Minimum Percent Solids Capture, %	95	95
Dry Polymer per Dry Solids Dewatered, lb/ton	12	11
Thickened Sludge Concentration, %	6	6
Operation	7 days a week, 10 hrs per day	7 days a week, 10 hrs per day
Sludge Stabilization Options		
1. Single-Phase Anaerobic Digestion		
Temperature, °C	35-37	35-37
Minimum SRT (All Digesters in Service), days	25	25
Minimum SRT (Large Digester Out of Service), days	13	13
Solids Loading Rate, lb/ft ³ -d	0.08	0.08
Average Volatile Solids Reduction, %	55	55
2. Two-Phase Anaerobic Digestion) Anaerobic+Aerobic		
Anaerobic Phase Temperature	35-37	35-37
Minimum Anaerobic SRT (All Digesters in Service), days	25	25
Minimum Anaerobic SRT (Large Digester Out of Service), days	13	13
Anaerobic Phase Solids Loading Rate, lb/ft ³ -d	0.08	0.08
Average Volatile Solids Reduction in Anaerobic Phase, days	55	55
Aerobic SRT, days	5	5
Total Volatile Solids Reduction (Anaerobic+Aerobic), %	65	65
3. Cannibal		
Percent Inert Material in Suspended Solids, %	25	25
Sludge Volume Index (SVI), mL/g	150	150
Organic Loading Rate, lbBOD/ft ³ -day	24	24
Biological Yield, lbTSS formed per lb BOD utilized	0.3	0.3
Sludge Dewatering Options		
1. Sludge Drying Beds		
Sludge Loading Rate, lb dry-solids/ft ² /year	12	12
Average Dry Cake Solids Content, %	23	23
2. Belt Filter Press		
Dry Feed Solids, %	2.4-2.8	2.4-2.8
Hydraulic Loading Rate, gpm/meter	25-100	25-100
Solids Loading Rate, lb/h-meter	400-700	400-700
Belt Width, meter	2	2

TABLE 1-1
Design Criteria for CAS and MBR Treatment Options

Process	CAS Design Criteria	MBR Design Criteria
Minimum Percent Solids Capture, %	95	95
Dry Polymer per Dry Solids Dewatered, lb/ton	26	26
Dry Cake Solids Content, %	20	20
Operation	7 days a week 10 hrs per day	7 days a week 10 hrs per day
3. Solar Drying Beds		
Minimum Feed Dry Solids Content, %	23	23
Dewatered Sludge Solids Cake Content, %	75	75

2.0 Upgrade/Modification and Expansion Needs for the Treatment Options

The design criteria presented in Table 1-1 were used in process and facility sizing using Pro2D. For proprietary technologies (i.e., Cannibal, solar drier, digester mixers), the sizing and upgrade requirements as well as capital and O&M costs were obtained from the equipment suppliers. The process modeling showed that increased sludge loading, as a result of CAS or MBR implementation, requires converting the existing secondary digester to a primary digester. In addition, thickening of WAS is required to avoid adding one digester (39 feet). With the exception of Cannibal options, which do not generate WAS, all of the treatment alternatives included sludge thickening. Two thickening alternatives, gravity belt thickening and rotary drum thickening, were sized and compared on a cost basis.

Table 2-1 presents upgrade/modification and expansion needs for CAS and MBR options. In certain cases, the capacity of the existing infrastructure is sufficient to handle future flows and loads without any upgrade (i.e., flow equalization basins). A condition assessment of the existing facilities indicated that these facilities can be used in the future.

The upgrade requirement for and cost associated with the recycled water storage tanks, chlorination facility for re-disinfecting long-term stored water for high-end users, uninterrupted power system, and new laboratory, shop, and garage will be included in TM 5 considering that these facilities have no impact on the process selection.

TABLE 2-1
Upgrade, Modification, and Expansion Needs for CAS and MBR Options for Ultimate Capacity

Unit Treatment Process	Existing Facilities	Upgrade/Modification/ Expansion Needs	
		CAS	MBR
Headworks	One step screen (3-mm opening), one aerated grit removal chamber, and three (2 duty+1 stand-by) centrifugal pumps, each with 2,000 gpm. Existing headworks is old (50 years) and already approached its useful life. Existing flow management in headworks is complex where grit removal is provided before screening.	Build a new headworks to handle peak flows of up to 13.0 mgd. The new headworks will include influent pump station, screening, and grit removal. (Existing Huber step screen and conductivity meter will be used in the new headworks.)	Build a new headworks to handle peak flows of up to 13.0 mgd. The new headworks will include influent pump station, screening, and grit removal. (Existing Huber step screen and conductivity meter will be used in the new headworks.)
Primary Settling Tanks	Two primary settling tanks each with a diameter of 65 ft. Condition of the primary clarifier mechanisms is bad due to significant corrosion. Concrete of primary clarifiers looks OK (may require more detailed evaluation to determine condition of the concrete structure).	Option I: Add two new primary clarifiers with 75-ft diameter. Option II: Replace existing clarifier drives, bridges, influent risers and baffles, and scraper mechanisms.	Option I: Add two new primary clarifiers with 75-ft diameter. Option II: Replace existing clarifier drives, bridges, influent risers and baffles, and scraper mechanisms.
Flow Storage Basins	One at 2 MG (Low-TDS Pond). One at 1 MG (High-TDS Pond).	None. Each basin was recently lined.	None. Each basin was recently lined.
Activated Sludge Basins	None.	Add four new activated sludge basins (trains) each with a capacity of 0.52 MG. Furnish each basin with anoxic zone, fine-bubble air diffuser system and mixed liquor recycle pumps.	Add four new activated sludge basins (trains) each with a capacity of 0.27 MG. Furnish each basin with anoxic zone, fine-bubble air diffuser system and mixed liquor recycle pumps.
Aeration Blowers	None.	Add 2 (1 duty+1 stand-by) 310-HP multi-stage centrifugal blowers for process air and mixing.	Add 2 (1 duty+1 stand-by) 375 HP multi-stage centrifugal blowers for process air and mixing.
MBR System Membrane Tanks, Membrane Cassettes, and Ancillary Equipment	None.	None (not applicable to CAS).	Add four new membrane tanks (trains) each with a capacity of 0.04 MG. Furnish the system with coarse-bubble aeration system, backwash and chemical cleaning system, permeate, and vacuum systems.

TABLE 2-1
Upgrade, Modification, and Expansion Needs for CAS and MBR Options for Ultimate Capacity

Unit Treatment Process	Existing Facilities	Upgrade/Modification/ Expansion Needs	
		CAS	MBR
Secondary Clarifiers	1 at 90-ft diameter.	Abandon the existing clarifier (shallow and old). Add three new 75-ft clarifiers with a SWD of 16 ft.	None (not applicable to MBR).
RAS/WAS/ Pump Station	None.	Add 2 (1 duty+1 stand-by) RAS pumps. Each RAS pump 3,600 gpm with a TDH of 25 ft. Add 2 (1 duty+1 stand-by) WAS pumps. Each WAS pump 300 gpm with a TDH of 30 ft.	Add 3 (2 duty+1 stand-by) RAS pumps. Each RAS pump 9,800 gpm with a TDH of 25 ft. Add 2 (1 duty+1 stand-by) WAS pumps. Each WAS pump 300 gpm with a TDH of 30 ft.
<i>Tertiary Filtration Options</i>			
Membrane Filtration	3.2-mgd ZeeWeed® 500 Ultrafiltration tertiary membrane facility with CIP and other auxiliary facilities.	Expand facility to treat average annual flow of 4.5 mgd adding one identical membrane train to the existing two trains. Upgrade actuators, valves, and vacuum compressor per NEMA 4X standards.	None (not applicable to MBR). Reuse of ZeeWeed® UF membranes could reduce capital cost of MBR facilities, depending upon conditions of the membranes at the time when implementation is taken place. However, due to uncertainty on implementation schedule right now, the cost estimate considered using new membranes in the MBR system.
Cloth Media Disc Filter-AquaDisk Supplied by Aqua Aerobic Systems	None.	Add two steel tanks with 12 Aquadisk units in each tank and backwash assembly.	None (not applicable to MBR).
<i>UV Expansion Options</i>			
UV System Expansion with Membrane Filtration	Medium pressure UV system with four banks.	Expand the facility capacity by adding two banks. Modify the existing pipe feeding the UV system to improve hydraulics. Add a break tank between membrane filtration and the UV disinfection system to operate UV system at nearly constant flow.	Expand facility capacity by adding two banks. Modify the existing pipe feeding the UV system to improve hydraulics. Add a break tank between membrane filtration and the UV disinfection system to operate UV system at nearly constant flow.

TABLE 2-1
Upgrade, Modification, and Expansion Needs for CAS and MBR Options for Ultimate Capacity

Unit Treatment Process	Existing Facilities	Upgrade/Modification/ Expansion Needs	
		CAS	MBR
UV System Expansion with Cloth Media Filtration	Medium pressure UV system with four banks.	Expand the facility capacity by adding four banks. Modify the existing pipe feeding the UV system to improve hydraulics.	None (not applicable to MBR).
Sludge Thickening Options			
Gravity Belt Thickener	None.	Add two (1 duty+1 stand-by) 1.5-meter gravity belt thickeners. Facility cost includes installed equipment cost, polymer feed system, and a building to house the equipment.	Add two (1 duty+1 stand-by) 1.5-meter gravity belt thickeners. Facility cost includes installed equipment cost, polymer feed system, and a building to house the equipment.
Rotary Drum Thickener	None.	Add two (1 duty+1 stand-by) rotary drum thickener. Facility cost includes installed equipment cost, polymer feed system, and a building to house the equipment.	Add two (1 duty+1 stand-by) rotary drum thickener. Facility cost includes installed equipment cost, polymer feed system, and a building to house the equipment.
Sludge Stabilization Options			
Anaerobic Digestion	One 39-ft mesophilic digester (primary digester). One 55-ft sludge holding and decanting tank (secondary digester; no temperature or mixing provided).	Convert secondary digester to primary digester by adding one 7.5-HP linear motion mixer and one spiral heat exchanger with a hot water capacity of 120 gpm. Add a high-pressure storage sphere system for gas storage.	Convert secondary digester to primary digester by adding one 7.5-HP linear motion mixer and one spiral heat exchanger with a hot water capacity of 120 gpm. Add a high pressure storage sphere system for gas storage.
Aerobic Digestion	None.	Add a 0.17-MG tank, coarse-bubble aeration system and blower.	Add a 0.17-MG tank, coarse-bubble aeration system and blower.
Cannibal	None.	Add two Cannibal Interchange Reactors (each with a volume of 0.66 MG) and a solids separation module (two drum screens, screenings compactor, dumpster, hydro cyclone, and grit classifier) with control package.	Add two Cannibal Interchange Reactors (each with a volume of 0.66 MG) and a solids separation module (two drum screens, screenings compactor, dumpster, hydro cyclone, and grit classifier) with control package.

TABLE 2-1
Upgrade, Modification, and Expansion Needs for CAS and MBR Options for Ultimate Capacity

Unit Treatment Process	Existing Facilities	Upgrade/Modification/ Expansion Needs	
		CAS	MBR
Sludge Dewatering Options			
Sludge Drying Beds	Approximately 240,000-ft ² area available for sludge dewatering. This area is not lined.	Install HDPE liner and drain system to the existing area (185,000-ft ² area would be sufficient).	Install HDPE liner and drain system to the existing area (185,000-ft ² area would be sufficient).
Belt Filter Press	None.	Add one 2.0-meter belt filter press. Include a building to house equipment and polymer feed and storage system. No redundant unit. Install HDPE liner and drain system to approximately 60,000 -ft ² area in the drying beds to allow emergency sludge dewatering at the facility.	Add one 2.0-meter belt filter press. Include a building to house equipment and polymer feed and storage system. No redundant unit. Install HDPE liner and drain system to approximately 60,000-ft ² area in the drying beds to allow emergency sludge dewatering at the facility.
Solar Drier	None.	Add five drying chambers each measuring 42 ft wide and 204 ft long. Build drying chambers on concrete slabs.	Add five drying chambers each measuring 42 ft wide and 204 ft long. Build the drying chambers on concrete slabs.
Break Tank Before UV Disinfection	None.	Included under UV disinfection improvements.	Included under UV disinfection improvements.
High TDS MBR System (Zenogem)	0.5-mgd Zenogem MBR system to treat high-TDS stream that includes two package process trains housed in steel tanks and associated equipment and two break tanks.	Replace existing Zenogem steel tanks with concrete tanks and add 0.1-mgd package train to handle future flows.	Replace existing Zenogem steel tanks with concrete tanks and add 0.1-mgd package train to handle future flows.
Yard Piping, Flow Rerouting, and Electrical Upgrades for the New Plant Facilities	None.	Allocated for new piping, flow collections, and distribution structures and electrical upgrades (Assumed 10% of the total capital cost).	Allocated for new piping, flow collections and distribution structures, and electrical upgrades (Assumed 10% of the total capital cost).
Other Upgrades/Improvements¹			
Recycle Water Storage Tanks	None.	One 1.0-MG steel storage tank is currently under construction. LCSD planned to add three more 1.0-MG tanks in the future.	One 1.0-MG steel storage tank is currently under construction. LCSD planned to add three more 1.0-MG tanks in the future.

TABLE 2-1
Upgrade, Modification, and Expansion Needs for CAS and MBR Options for Ultimate Capacity

Unit Treatment Process	Existing Facilities	Upgrade/Modification/ Expansion Needs	
		CAS	MBR
Chlorinating Long-term Stored Recycled Water for High-End Users	None.	Add a chlorination system to allow re-disinfection of long-term stored recycle water for high-end users as necessary. Include chlorine storage, day tank, and two metering pumps (one duty+one stand-by).	Add a chlorination system to allow re-disinfection of long-term stored recycle water for high-end users as necessary. Include chlorine storage, day tank, and two metering pumps (one duty+one stand-by).
Uninterrupted Power Supply (UPS)	None.	Include a UPS system to allow uninterrupted operation of entire facility. Total power requirement for CAS option is 840 kW.	Include a UPS system to allow uninterrupted operation of entire facility. Total power requirement for CAS option is 880 kW.
New Laboratory, Shop, and Garage (Optional)	Existing facility has a small laboratory, shop, and garage.	Add new buildings for laboratory and shop and garage.	Add new buildings for laboratory and shop and garage.

¹Because these upgrades have no impact on the process selection, they are excluded in benefit-to-cost analysis and process selection. However, cost estimates regarding these upgrades will be included in TM 5.

3.0 Cost Estimate and Benefit-to-Cost Ratios for Treatment Options

Cost estimates were developed by obtaining budgetary-level equipment costs from the equipment suppliers and calculating facility costs using CH2M HILL's cost estimating methodology (CPES) for projects of similar type and size.

The cost estimates developed for this analysis provide a relative comparison of the treatment alternatives and are considered "order-of-magnitude" estimates. An order-of-magnitude cost estimate is defined as "an approximate estimate made without detailed engineering data." The Association for the Advancement of Cost Engineering (AACE) International defines order-of-magnitude costs as *Class 5* cost estimates without detailed engineering data. Examples of order-of-magnitude costs include: (1) an estimate from cost capacity curves, (2) an estimate using scale-up or scale-down factors, and (3) an approximate ratio estimate. The estimates shown, and any resulting conclusions on project financial or economic feasibility or funding requirements, have been prepared to guide project evaluation and implementation from the information available at the time of cost estimation. The expected accuracy ranges for a Class 5 cost estimate are -15 to -30 percent on the low side and +20 to +50 percent on the high side. The final costs of the project and resulting feasibility will depend on actual labor and material costs, competitive market conditions, actual site conditions, final project scope, implementation schedule, continuity of personnel and engineering, and other variable factors.

Capital costs, herein, reflects construction costs for the facilities and do not include engineering and design or legal fees. The following markups and contingencies were included in the facility costs:

- Mobilization: 10%
- Bond/Permits and Insurance: 3.5%
- Contractors Overheads: 15%
- Contractor Profit: 8%
- Project Contingency: 25%

Operations and maintenance costs items including chemicals, power, sludge hauling, and disposal costs were obtained from LCSD and were summarized in TM 3. Membrane replacement, part replacement, and maintenance costs were from CPES and leading equipment suppliers. A 20-year LCC, which is the total cost of ownership of equipment or technology, including its cost of acquisition, operations and maintenance, and decommission, was estimated to identify the most cost-effective alternatives from 16 (8 CAS+8 MBR) alternatives evaluated. Tables 3-1 and 3-2 present capital, O&M, and 20-year LCC (at 6 percent discount rate) for CAS and MBR options, respectively. The green highlighted cells in Table 3-1 refer to new processes or technologies whereas yellow highlighted cells refer to upgrades and expansion to the existing plant facilities.

TABLE 3-1
Cost Estimate Summary for CAS Alternatives

	Estimate Basis	Alternative 1	Alternative 2	Alternative 3	Alternative 4	Alternative 5	Alternative 6	Alternative 7	Alternative 8
Headworks	From CPES	\$7,300,000	\$7,300,000	\$7,300,000	\$7,300,000	\$7,300,000	\$7,300,000	\$7,300,000	\$7,300,000
Primary Clarifiers	From CPES	\$1,910,000	\$1,910,000	\$1,910,000	\$1,910,000	\$1,910,000	\$1,910,000	\$1,910,000	\$1,910,000
Activated Sludge Basins	From CPES	\$4,440,000	\$4,440,000	\$4,440,000	\$4,440,000	\$4,440,000	\$4,440,000	\$5,550,000	\$4,884,000
Aeration Blowers	From CPES	\$3,095,000	\$3,095,000	\$3,095,000	\$3,095,000	\$3,095,000	\$3,095,000	\$3,350,000	\$3,095,000
Secondary Clarifiers	From CPES	\$3,224,000	\$3,224,000	\$3,224,000	\$3,224,000	\$3,224,000	\$3,224,000	\$4,299,000	\$3,224,000
RAS/WAS Pump Station	From CPES	\$902,000	\$902,000	\$902,000	\$902,000	\$902,000	\$902,000	\$902,000	\$902,000
Expand Existing ZeeWeed® UF System	From GE-Zenon	\$2,930,000	\$0	\$2,930,000	\$2,930,000	\$0	\$2,930,000	\$2,930,000	\$2,930,000
Replace Existing ZeeWeed® with AquaDisk Filters	From Aqua Aerobics	\$0	\$1,147,000	\$0	\$0	\$1,147,000	\$0	\$0	\$0
New Break Tank Before UV System	From CPES	\$370,000	\$0	\$370,000	\$370,000	\$0	\$370,000	\$370,000	\$370,000
Expand Existing UV System	From CPES	\$750,000	\$1,300,000	\$750,000	\$750,000	\$1,300,000	\$750,000	\$750,000	\$750,000
Sludge Thickening	From CPES	\$1,704,000	\$1,704,000	\$1,704,000	\$1,704,000	\$1,704,000	\$1,704,000	\$0	\$0
Anaerobic Digester Improvements	From EIMCO	\$1,425,000	\$1,425,000	\$1,425,000	\$1,425,000	\$1,425,000	\$1,425,000	\$0	\$195,000
Aerobic Digestion	From CPES	\$0	\$0	\$0	\$0	\$0	\$1,900,000	\$0	\$0
Cannibal	From CPES	\$0	\$0	\$0	\$0	\$0	\$0	\$6,660,000	\$5,994,000

TABLE 3-1
Cost Estimate Summary for CAS Alternatives

	Estimate Basis	Alternative 1	Alternative 2	Alternative 3	Alternative 4	Alternative 5	Alternative 6	Alternative 7	Alternative 8
Dewatering via Belt Filter Press	From CPES	\$0	\$0	\$2,430,000	\$2,430,000	\$2,430,000	\$0	\$0	\$0
Dewatering Using Existing Sludge Drying Beds	From CPES	\$1,080,000	\$1,080,000	\$519,000	\$519,000	\$519,000	\$1,080,000	\$0	\$519,000
Solar Drier	From Parkson	\$0	\$0	\$0	\$5,254,000	\$5,254,000	\$0	\$0	\$0
Upgrade and Expand Existing Zenogem MBR System	From CPES and GE-Zenon	\$1,150,000	\$1,150,000	\$1,150,000	\$1,150,000	\$1,150,000	\$1,150,000	\$1,150,000	\$1,150,000
Subtotal		\$30,280,000	\$28,677,000	\$32,149,000	\$37,403,000	\$35,800,000	\$32,180,000	\$35,171,000	\$33,223,000
Subtotal Including Yard Piping and Electrical Upgrades¹		\$33,308,000	\$31,545,000	\$35,364,000	\$41,144,000	\$39,380,000	\$35,398,000	\$38,689,000	\$36,546,000
Markups and Contingencies									
Mobilization, 10% of the Subtotal	From TM 3	\$3,331,000	\$3,155,000	\$3,537,000	\$4,115,000	\$3,938,000	\$3,540,000	\$3,869,000	\$3,655,000
Bond, Permit, and Insurance, 3.5% of the Subtotal	From TM 3	\$1,166,000	\$1,105,000	\$1,238,000	\$1,441,000	\$1,379,000	\$1,239,000	\$1,355,000	\$1,280,000
Contractor Overheads, 15% of the Subtotal	From TM 3	\$4,997,000	\$4,732,000	\$5,305,000	\$6,172,000	\$5,907,000	\$5,310,000	\$5,804,000	\$5,482,000
Contractor Profit, 8% of the Subtotal	From TM 3	\$2,665,000	\$2,524,000	\$2,830,000	\$3,292,000	\$3,151,000	\$2,832,000	\$3,096,000	\$2,924,000

TABLE 3-1
Cost Estimate Summary for CAS Alternatives

	Estimate Basis	Alternative 1	Alternative 2	Alternative 3	Alternative 4	Alternative 5	Alternative 6	Alternative 7	Alternative 8
Project Contingency, 25% of the Subtotal	From TM 3	\$8,327,000	\$7,887,000	\$8,841,000	\$10,286,000	\$9,845,000	\$8,850,000	\$9,673,000	\$9,137,000
TOTAL CAPITAL COST, \$		\$53,794,000	\$50,948,000	\$57,115,000	\$66,450,000	\$63,600,000	\$57,169,000	\$62,486,000	\$59,024,000
O&M Cost, \$/year									
CAS System	From CPES	\$543,000	\$543,000	\$543,000	\$543,000	\$543,000	\$543,000	\$663,000	\$543,000
ZeeWeed® 500 Ultrafiltration	From GE-Zenon	\$290,000	\$0	\$290,000	\$290,000	\$0	\$290,000	\$290,000	\$290,000
AquaDisk Filters	From Aqua Aerobics	\$0	\$54,000	\$0	\$0	\$54,000	\$0	\$0	\$0
UV System	From CPES	\$133,000	\$211,000	\$133,000	\$133,000	\$211,000	\$133,000	\$133,000	\$133,000
Sludge Thickening	From CPES	\$76,000	\$76,000	\$76,000	\$76,000	\$76,000	\$76,000	\$0	\$0
Anaerobic Digestion	From similar projects	\$46,000	\$46,000	\$46,000	\$46,000	\$46,000	\$46,000	\$0	\$36,000
Aerobic Digestion	From CPES	\$0	\$0	\$0	\$0	\$0	\$90,000	\$0	\$0
Cannibal	From Siemens	\$0	\$0	\$0	\$0	\$0	\$0	\$222,000	\$200,000
Dewatering via Belt Filter Press	From CPES	\$0	\$0	\$118,000	\$118,000	\$118,000	\$0	\$0	\$0
Sludge Drying Beds		\$41,000	\$41,000	\$14,000	\$14,000	\$14,000	\$41,000	\$0	\$0
Solar Drier	From Parkson	\$0	\$0	\$0	\$53,000	\$53,000	\$0	\$0	\$0
Sludge Hauling		\$155,000	\$155,000	\$170,000	\$47,000	\$47,000	\$124,000	\$0	\$0

TABLE 3-1
Cost Estimate Summary for CAS Alternatives

	Estimate Basis	Alternative 1	Alternative 2	Alternative 3	Alternative 4	Alternative 5	Alternative 6	Alternative 7	Alternative 8
Total O&M Cost, \$/year		\$1,284,000	\$1,126,000	\$1,390,000	\$1,320,000	\$1,162,000	\$1,343,000	\$1,308,000	\$1,202,000
Potential Biogas to Energy O&M Cost Saving, \$/year	From Pro2D	-\$239,000	-\$239,000	-\$239,000	-\$239,000	-\$239,000	-\$239,000	\$0	-\$148,000
TOTAL O&M Cost Including Biogas to Energy Cost Saving, \$/year		\$1,045,000	\$887,000	\$1,151,000	\$1,081,000	\$923,000	\$1,104,000	\$1,308,000	\$1,054,000
LCC (Excludes Potential Biogas to Energy Saving)², \$		\$68,521,000	\$63,863,000	\$73,058,000	\$81,590,000	\$76,928,000	\$72,573,000	\$77,489,000	\$72,811,000
LCC (Includes Potential Biogas to Energy Saving), \$		\$65,780,000	\$61,122,000	\$70,317,000	\$78,849,000	\$74,187,000	\$69,832,000	\$77,489,000	\$71,113,000

¹10% of the subtotal is allocated for yard piping and electrical upgrades.

²Values used in the benefit-to-cost analysis

TABLE 3-2
Cost Estimate Summary for MBR Options

	Cost Estimate Basis	Alternative 9	Alternative 10	Alternative 11	Alternative 12	Alternative 13	Alternative 14	Alternative 15	Alternative 16
Headworks	From CPES	\$7,300,000	\$7,300,000	\$7,300,000	\$7,300,000	\$7,300,000	\$7,300,000	\$7,300,000	\$7,300,000
Primary Clarifiers	From CPES	\$1,910,000	\$1,910,000	\$1,910,000	\$1,910,000	\$1,910,000	\$1,910,000	\$1,910,000	\$1,910,000
Activated Sludge Basins	From CPES	\$3,000,000	\$3,000,000	\$3,000,000	\$4,100,000	\$4,100,000	\$3,457,000	\$3,457,000	\$3,000,000
Aeration Blowers	From CPES	\$3,806,000	\$3,806,000	\$3,806,000	\$4,071,000	\$4,071,000	\$3,806,000	\$3,806,000	\$3,806,000
MBR Tanks and Auxiliary Equipment	From GE-Zenon	\$7,607,000	\$7,607,000	\$7,607,000	\$7,607,000	\$7,607,000	\$7,607,000	\$7,607,000	\$7,607,000
RAS/WAS Pump Station	From CPES	\$1,488,000	\$1,488,000	\$1,488,000	\$1,560,000	\$1,560,000	\$1,488,000	\$1,488,000	\$1,488,000
New Break Tank Before UV System	From CPES	\$370,000	\$370,000	\$370,000	\$370,000	\$370,000	\$370,000	\$370,000	\$370,000
Expand Existing UV System	From CPES	\$750,000	\$750,000	\$750,000	\$750,000	\$750,000	\$750,000	\$750,000	\$750,000
Sludge Thickening	From CPES	\$1,704,000	\$1,704,000	\$1,704,000	\$0	\$0	\$0	\$0	\$1,704,000
Anaerobic Digester Improvements	From EIMCO	\$1,425,000	\$1,425,000	\$1,425,000	\$0	\$0	\$195,000	\$195,000	\$1,425,000
Aerobic Digester	From CPES	\$0	\$0	\$0	\$0	\$0	\$0	\$0	\$1,900,000
Dewatering via Belt Filter Press	From CPES	\$0	\$2,430,000	\$2,430,000	\$0	\$0	\$0	\$0	\$0
Dewatering Using Existing Sludge Drying Beds	From CPES	\$1,080,000	\$519,000	\$519,000	\$519,000	\$0	\$519,000	\$0	\$886,000
Cannibal Process	From Siemens	\$0	\$0	\$0	\$6,660,000	\$6,660,000	\$5,254,000	\$5,254,000	\$0

TABLE 3-2
Cost Estimate Summary for MBR Options

	Cost Estimate Basis	Alternative 9	Alternative 10	Alternative 11	Alternative 12	Alternative 13	Alternative 14	Alternative 15	Alternative 16
Solar Drier	From Parkson	\$0	\$0	\$5,254,000	\$0	\$0	\$0	\$0	\$0
Upgrade and Expand Existing Zenogem MBR System	From CPES and GE-Zenon	\$1,150,000	\$1,150,000	\$1,150,000	\$1,150,000	\$1,150,000	\$1,150,000	\$1,150,000	\$1,150,000
Yard Piping and Flow Rerouting	From CPES	\$2,000,000	\$2,000,000	\$2,000,000	\$2,000,000	\$2,000,000	\$2,000,000	\$2,000,000	\$2,000,000
Subtotal		\$31,590,000	\$33,459,000	\$38,713,000	\$35,997,000	\$35,478,000	\$33,806,000	\$33,287,000	\$33,296,000
Subtotal Including Yard Piping and Electrical Upgrades¹		\$34,749,000	\$36,805,000	\$42,585,000	\$39,597,000	\$39,026,000	\$37,187,000	\$36,616,000	\$36,626,000
Markups and Contingencies									
Mobilization, 10% of the Subtotal	From TM 3	\$3,475,000	\$3,681,000	\$4,259,000	\$3,960,000	\$3,903,000	\$3,719,000	\$3,662,000	\$3,663,000
Bond, Permit, and Insurance, 3.5% of the Subtotal	From TM 3	\$1,217,000	\$1,289,000	\$1,491,000	\$1,386,000	\$1,366,000	\$1,302,000	\$1,282,000	\$1,282,000
Contractor Overheads, 15% of the Subtotal	From TM 3	\$5,213,000	\$5,521,000	\$6,388,000	\$5,940,000	\$5,854,000	\$5,579,000	\$5,493,000	\$5,494,000
Contractor Profit, 8% of the Subtotal	From TM 3	\$2,780,000	\$2,945,000	\$3,407,000	\$3,168,000	\$3,123,000	\$2,975,000	\$2,930,000	\$2,931,000

TABLE 3-2
Cost Estimate Summary for MBR Options

	Cost Estimate Basis	Alternative 9	Alternative 10	Alternative 11	Alternative 12	Alternative 13	Alternative 14	Alternative 15	Alternative 16
Project Contingency, 25% of the Subtotal	From TM 3	\$8,688,000	\$9,202,000	\$10,647,000	\$9,900,000	\$9,757,000	\$9,297,000	\$9,154,000	\$9,157,000
TOTAL CAPITAL COST, \$		\$56,122,000	\$59,443,000	\$68,777,000	\$63,951,000	\$63,029,000	\$60,059,000	\$59,137,000	\$59,153,000
O&M Cost, \$/year									
MBR System	From CPES+GE-Zenom	\$814,000	\$814,000	\$814,000	\$863,000	\$863,000	\$814,000	\$814,000	\$814,000
UV System	From CPES	\$133,000	\$133,000	\$133,000	\$133,000	\$133,000	\$133,000	\$133,000	\$133,000
Sludge Thickening	From CPES	\$72,000	\$72,000	\$72,000	\$0	\$0	\$0	\$0	\$72,000
Anaerobic Digestion	From similar projects	\$46,000	\$46,000	\$46,000	\$0	\$0	\$36,000	\$36,000	\$46,000
Aerobic Digester	From CPES	\$0	\$0	\$0	\$0	\$0	\$0	\$0	\$90,000
Dewatering via Belt Filter Press	From CPES	\$0	\$117,000	\$117,000	\$0	\$0	\$0	\$0	\$90,000
Cannibal	From Siemens	\$0	\$0	\$0	\$162,000	\$222,000	\$162,000	\$222,000	\$0
Sludge Drying Beds	From CPES	\$41,000	\$14,000	\$14,000	\$14,000	\$0	\$14,000	\$0	\$41,000
Solar Drier	From Parkson	\$0	\$0	\$50,000	\$0	\$0	\$0	\$0	\$0
Sludge Hauling	From TM 3	\$151,000	\$151,000	\$47,000	\$0	\$0	\$0	\$0	\$124,000
Total O&M Cost, \$/year		\$1,257,000	\$1,347,000	\$1,293,000	\$1,172,000	\$1,218,000	\$1,159,000	\$1,205,000	\$1,410,000

TABLE 3-2
Cost Estimate Summary for MBR Options

	Cost Estimate Basis	Alternative 9	Alternative 10	Alternative 11	Alternative 12	Alternative 13	Alternative 14	Alternative 15	Alternative 16
Potential Biogas to Energy O&M Cost Saving, \$/year	From Pro2D	-\$227,000	-\$227,000	-\$227,000	\$0	\$0	-\$148,000	-\$148,000	-\$227,000
TOTAL O&M Cost Including Savings, \$/year		\$1,030,000	\$1,120,000	\$1,066,000	\$1,172,000	\$1,218,000	\$1,011,000	\$1,057,000	\$1,183,000
LCC (Excludes Potential Biogas to Energy Saving)², \$		\$70,540,000	\$74,893,000	\$83,608,000	\$77,394,000	\$76,999,000	\$73,353,000	\$72,958,000	\$75,326,000
LCC (Includes Potential Biogas to Energy Saving), \$		\$67,936,000	\$72,289,000	\$81,004,000	\$77,394,000	\$76,999,000	\$71,655,000	\$71,261,000	\$72,722,000

¹10% of the subtotal is allocated for yard piping and electrical upgrades.

² Values used in the benefit-to-cost analysis

The sludge thickening costs presented in Tables 3-1 and 3-2 are based on rotary drum thickening, which offered a capital cost saving of approximately \$400,000 over gravity belt thickening with identical O&M costs. Cost details are presented in Appendixes A and B.

For MBR option, two alternatives were evaluated for upgrading the existing Zenogem MBR system. The option of replacing the existing steel tanks with concrete tanks offered better cost savings than allocating an MBR train on the proposed MBR system to treat high and low TDS streams separately in one system.

Projected biogas generation and corresponding cost savings³ for CAS and MBR options include proposed digester upgrades. In each option, 55 percent VS reduction and a biogas yield of 15 cubic feet biogas per pound VS destroyed were used. The potential cost savings (offsets) were estimated using electricity purchase rate of \$0.15/kilowatt-hour (kWh).

The ability to use the existing facilities such as tertiary filters for the CAS system result in the capital costs of CAS options to be slightly lower than those for the MBR options. However, the LCC cost difference of approximately 2 percent between Alternative 1 (CAS option) and Alternative 9 (MBR option) indicates that the difference is in fact within the error range of the Class 5 cost estimate. The B/C ratios are identical for Alternative 1 (0.327) and Alternative 9 (0.328), thereby suggesting that Alternative 1 and Alternative 9 are equally qualified as the treatment alternatives.

A greenhouse drier can significantly improve solids dry cake content and potentially meet the Class A requirement. However, relatively high equipment cost makes this alternative unattractive. This alternative would be attractive in locations with higher biosolids hauling and disposal costs, and with tight site space availability.

The LCC estimates indicate that the Cannibal options offer substantial saving on sludge disposal costs but require higher initial investment.

Because selection of the most suitable treatment alternative(s) will be determined based on B/C ratios rather than LCC alone, the B/C ratios were evaluated for treatment technology selection. Figure 3-1 illustrates the LCCs along with B/C ratios for all CAS and MBR alternatives (total 16) evaluated. Table 3-3 presents the results in tabular form and provides ranking for the alternatives.

³ Savings due to not purchasing electricity from PG&E at \$0.15 kWh.

FIGURE 3-1
LCCs, B/C Ratios for Treatment Alternatives

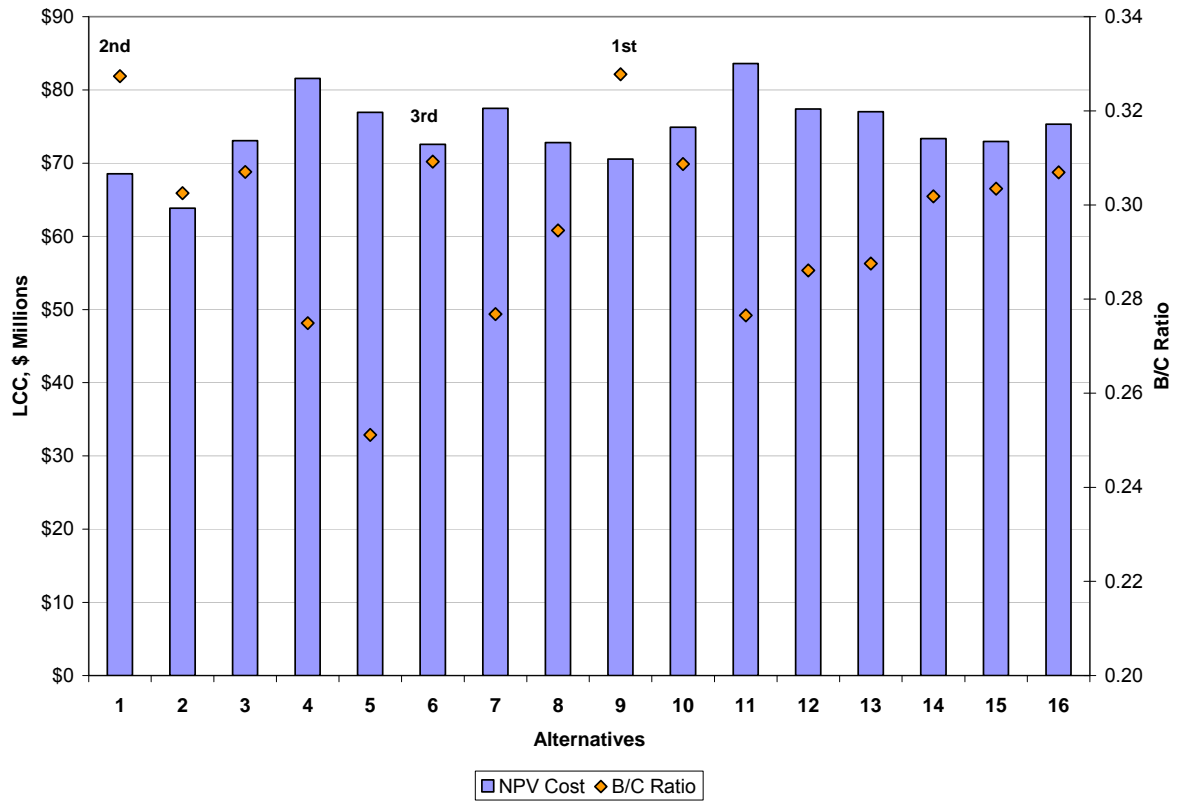

TABLE 3-3
LCCs, Total Benefit Scores, B/C Ratios, and Alternative Rankings for Treatment Alternatives

Alternatives	LCC (\$M)	Total Benefit Scores	B/C Ratios	B/C Ranking	LCC Ranking
Alternative 1 CAS+MF+ ST+SPAD+SDB	68.5	22.4	0.327	2	2
Alternative 2 CAS+CMF+ST+SPAD+SDB	63.9	19.3	0.303	8	1
Alternative 3 CAS+MF+ST+SPAD+BFP	73.1	22.4	0.307	5	7
Alternative 4 CAS+MF+ST+SPAD+SD	81.6	22.4	0.275	15	15
Alternative 5 CAS+CMF+ST+SPAD+SD	76.9	19.3	0.251	16	11
Alternative 6 CAS+MF+ ST+TPD+SDB	72.6	22.4	0.310	3	4

TABLE 3-3
LCCs, Total Benefit Scores, B/C Ratios, and Alternative Rankings for Treatment Alternatives

Alternatives	LCC (\$M)	Total Benefit Scores	B/C Ratios	B/C Ranking	LCC Ranking
Alternative 7 CAS+MF+ Cannibal+Rental BFP (no primary settling)	77.5	21.5	0.277	13	14
Alternative 8 CAS+MF+ Cannibal+SDB (no primary settling)	72.8	21.5	0.295	10	5
Alternative 9 MBR+ST+SPAD+SDB	70.5	23.1	0.328	1	3
Alternative 10 MBR+ST+SPAD+BFP	74.9	23.1	0.309	4	9
Alternative 11 MBR+ST+SPAD+SD	83.6	23.1	0.277	14	16
Alternative 12 MBR+Cannibal+BFP (no primary settling)	77.4	22.1	0.286	12	13
Alternative 13 MBR+Cannibal+SDB (no primary settling)	77.0	22.1	0.288	11	12
Alternative 14 MBR+Cannibal+SPAD+SDB	73.4	22.1	0.302	9	8
Alternative 15 MBR+Cannibal+SPAD+Rental BFP	73.0	22.1	0.303	7	6
Alternative 16 MBR+ST+TPD+SDB	75.3	23.1	0.307	6	10

BFP: belt filter press
CAS: conventional activated sludge
CMF: cloth media filtration
MBR: membrane bioreactor
MF: membrane filtration
SD: solar drier
SDB: sludge drying bed
SPAD: single-phase anaerobic digestion
ST: sludge thickening
TPD: two-phase digestion

Figure 3-1 and Table 3-3 show that Alternatives 1, 9, and 6 exhibited the highest B/C ratios and are the top three alternatives. Alternatives 1 and 6 are very similar but the latter includes an additional aerobic digestion step (two-phase digestion) to improve VS reduction and consequently reduce biosolids handling costs. A sensitivity analysis was performed to compare Alternatives 1 and 6 under following scenarios:

- *Scenario 1:* 30 percent increase in current biosolids hauling cost only. Under this scenario, a biosolids disposal cost of \$51.3/ton biosolids was used (\$39.5x1.3).
- *Scenario 2:* 10 percent increase in electricity cost only. Under this scenario, an electricity cost of \$0.165/kWh used (1.1X\$0.15/kWh).
- *Scenario 3:* 30 percent increase in current biosolids hauling cost and 10 percent increase in electricity cost.

The sensitivity analysis results are presented in Table 3-4.

TABLE 3-4
Sensitivity Analysis Scenarios for Alternative 1 and 6

	Scenario I (Increase in Biosolids Disposal Cost, \$/year)	Scenario II (Increase in Power Cost, \$/year)	Scenario III (Increase in Biosolids Disposal Cost and Power, \$/year)
Alternative 1 (Single-Phase Anaerobic Digestion)	47,000	1,300	48,300
Alternative 6 (Two-Phase Digestion)	37,000	10,000	47,000
Net O&M Cost Difference Between Alternatives 1 and 6, \$/year	+10,000	-8,700	+1,300
Net LCC Difference Between Alternatives 1 and 6, \$	+115,000	-100,000	+15,000

Table 3-4 indicates that Alternative 6 (CAS + membrane filtration + sludge thickening (WAS only) + two-phase digestion (anaerobic-aerobic) + sludge dewatering using sludge drying beds) can offer up to \$10,000 year O&M cost saving or \$115,000 LCC saving over Alternative 1 (CAS + membrane filtration + sludge thickening (WAS only) + single-phase anaerobic digestion + sludge dewatering using sludge drying beds) if biosolids hauling costs increase, but the reverse is true in the event that electricity costs increase. Therefore, there is not a significant difference between the two alternatives.

3.1 Recommendations

The objective of this TM was to determine the most suitable technology based on the B/C ratios developed for the treatment alternatives developed previously in this study. The B/C ratios showed that Alternative 1 (CAS+MF+ ST+SPAD+SDB) and Alternative 9 (MBR+ST+SPAD+SDB) exhibited the highest benefit scores among 16 treatment alternatives summarized. Although LCC for Alternative 1 is slightly lower (approximately 2 percent) than that for Alternative 9, the B/C scores were nearly identical for Alternative 1 and Alternative 9, which pointed to two equally beneficial treatment alternatives to meet the LCSD goals. The B/C ratios clearly indicate that the differences between Alternatives 1 and 9 are well within the error range of cost estimation, and both alternatives are equally

qualified. To move forward with the selection of one alternative for LCSD, additional steps such as further evaluation of the advantages of each alternative and obtaining further feedback from the plant operators were taken.

MBR has unique advantages over CAS, such as reducing the facility footprint (see Figures 3-2 and 3-3). Although superior effluent quality is not the major interest at this moment, MBR may be a better fit to meet stringent future recycle water regulations, which may include micro-pollutants (i.e., pharmaceuticals, personal care products, and endocrine disrupting compounds). Numerous research studies indicate that MBR systems are capable of removing a greater percentage of micro-pollutants compared to typical CAS systems coupled with membrane filtration as in Alternative 1. Microfiltration performance after the CAS system is heavily dependent on the sludge settling characteristics and the performance of the secondary clarifiers. The recent advancements in MBR design practices (i.e., cyclic air on/off) significantly lowered the MBR power requirements and made MBR power and carbon footprint competitive to the CAS systems.

LCSD is currently operating a submerged membrane filtration facility (ZeeWeed® Ultrafiltration) and a small MBR system (Zenogem). LCSD staff expressed concern about the ZeeWeed® membrane filtration system and its continued useful life due to mechanical failures such as membrane fiber failures, material corrosion, and increased repair needs for valves and actuators used in the membrane system. Therefore, the existing system has recurring maintenance costs at a much more frequent interval compared to typical tertiary membrane filtration facilities. LCSD, however, has had good success with the operation of the MBR system. It should be noted that the cost estimation in this TM assumed that the existing ZeeWeed® system will be expanded for a future phase with the minimum upgrades to the existing units. This was assumed considering the anticipated improvement in feedwater quality with the CAS implementation. However, if the maintenance and frequent repair needs are not reduced in the future, LCC (both labor and material costs) for the CAS system could be much higher than what this evaluation forecasted. In light of these and LCSD O&M staff feedback based on their operating experience with the two systems, Alternative 9 was identified as the most favorable option of the two.

Alternative 2 (CAS coupled with cloth media filtration) appears as the most economical alternative based on LCC, but it was found to have a much lower benefit score than Alternative 9 or Alternative 1. The main drawback of cloth media filters is its inability to produce high-quality effluent, which is critical for the performance and sizing of the downstream ultraviolet (UV) disinfection facilities. Changing the existing membrane filtration to cloth media or not implementing MBR would require upgrade and expansion of the existing UV system as well as re-validation of the UV system at 55 percent UV transmittance according to the National Water Research Institute (NWRI) and American Water Works Association Research Foundation (AWWARF) UV Guidelines. These upgrades and re-validation could be lengthy, cumbersome, and costly (cost for revalidation testing was not included in this evaluation).

Based on the foregoing evaluation and findings, it is recommended that the further evaluation for the facility plan be completed using Alternative 9 as the treatment alternative.

Currently, CH2M HILL is working on a scope to evaluate renewable energy options for LCSD. This evaluation will identify the capacity of renewable energy technology to meet

future energy demand of the plant, footprint requirement as well as state and federal incentives available for the renewable energy options, and payback calculations to evaluate the long-term benefits and ownership options for the renewable energy alternatives.

In addition, CH2M HILL will provide a summary of the current status of the California Renewable Portfolio Standards (RPS). Under RPS programs, energy utilities need to acquire Renewable Energy Credits (RECs) by providing renewables as part of their energy portfolio. If LCSD moves forward into negotiations with a renewable energy provider, it will be important to understand the value and ownership of the RECs associated with the project.

FIGURE 3-2
CAS Site Layout



FIGURE 3-3
MBR Site Layout



Appendix A
Cost Estimate Details for CAS

Headworks	Capital Cost, \$
Sitework	\$ 239,000
Concrete	\$ 860,000
Building	\$ 408,000
Metals	\$ 68,000
Equipment	\$ 3,609,000
Instrumentation & Controls	\$ 200,000
Mechanical	\$ 132,000
Electrical	\$ 90,000
Subtotal	\$ 5,606,000
Finishes Allowance (2%)	\$ 113,000
I&C Allowance (4%)	\$ 225,000
Mechanical Allowance (20%)	\$ 1,122,000
Electrical Allowance (4%)	\$ 225,000
Total	\$ 7,300,000

Headworks	O&M Cost, \$/year
Power	\$ 192,000
Maintenance (1% of the Capital Investment)	\$ 73,000
Total	\$ 265,000

Upgrading the Existing Primary Clarifiers	Capital Cost, \$
Metals	\$ 124,000
Equipment	\$ 560,000
Mechanical and Electrical	\$ 150,000
Subtotal	\$ 834,000
Finishes Allowance (2%)	\$ 12,000
I&C Allowance (2%)	\$ 12,000
Mechanical Allowance (5%)	\$ 30,000
Electrical Allowance (2%)	\$ 12,000
Total	\$ 900,000

New Primary Clarifiers	Capital Cost, \$
Sitework	\$ 194,000
Concrete	\$ 500,000
Metals	\$ 134,000
Equipment	\$ 720,000
Mechanical and Electrical	\$ 15,000
Subtotal	\$ 1,561,000
Finishes Allowance (2%)	\$ 63,000
I&C Allowance (4%)	\$ 63,000
Mechanical Allowance (20%)	\$ 157,000
Electrical Allowance (4%)	\$ 63,000
Total	\$ 1,910,000

Activated Sludge Basins, Mixers, and Diffuse Aeration System	Capital Cost, \$
Sitework	\$ 220,000
Concrete	\$ 1,700,000
Metals	\$ 195,000
Equipment	\$ 770,000
Instrumentation & Controls	\$ 262,000
Mechanical	\$ 410,000
Electrical	\$ 110,000
Subtotal	\$ 3,667,000
Finishes Allowance (3%)	\$ 111,000
I&C Allowance (5%)	\$ 184,000
Mechanical Allowance (8%)	\$ 294,000
Electrical Allowance (5%)	\$ 184,000
Total	\$ 4,440,000

Process Air Blowers	Capital Cost, \$
Sitework	\$ 9,000
Concrete	\$ 23,000
Building	\$ 177,000
Equipment	\$ 318,000
Instrumentation & Controls	\$ 105,000
Mechanical	\$ 607,000
Electrical	\$ 200,000
Subtotal	\$ 1,439,000
Finishes Allowance (2%)	\$ 29,000
I&C Allowance (3%)	\$ 44,000
Mechanical Allowance (5%)	\$ 72,000
Electrical Allowance (5%)	\$ 72,000
Total	\$ 3,095,000

Secondary Clarifiers	Capital Cost, \$
Sitework	\$ 550,000
Concrete	\$ 1,350,000
Metals	\$ 280,000
Equipment	\$ 870,000
Mechanical	\$ 25,000
Subtotal	\$ 3,075,000
Finishes Allowance (4%)	\$ 40,000
I&C Allowance (2%)	\$ 20,000
Mechanical Allowance (5%)	\$ 49,000
Electrical Allowance (4%)	\$ 40,000
Total	\$ 3,224,000

RAS/WAS Pump Station	Capital Cost, \$
Sitework	\$ 23,000
Concrete	\$ 79,000
Building	\$ 180,000
Equipment	\$ 225,000
Instrumentation & Controls	\$ 96,000
Mechanical	\$ 107,000
Electrical	\$ 100,000
Subtotal	\$ 810,000
Finishes Allowance (2%)	\$ 17,000
I&C Allowance (3%)	\$ 17,000
Mechanical Allowance (5%)	\$ 41,000
Electrical Allowance (5%)	\$ 17,000
Total	\$ 902,000

CAS (Includes Activated Sludge Basins, Aeration Blowers, Secondary Clarifiers, and RAS/WAS Pump Station)	O&M Cost, \$/year
Power	\$ 395,000
Maintenance (2% of the Capital Investment)	\$ 151,000
Total	\$ 546,000

UF System Expansion	Capital Cost, \$
Sitework	\$ 9,000
Concrete	\$ 57,000
Metals	\$ 7,000
Building	\$ 391,000
Equipment	\$ 1,443,000
Instrumentation and Control	\$ 37,000
Mechanical	\$ 194,000
Electrical	\$ 61,000
Subtotal	\$ 2,199,000
Finishes Allowance (2%)	\$ 44,000
I&C Allowance (4%)	\$ 88,000
Mechanical Allowance (5%)	\$ 110,000
Electrical Allowance (4%)	\$ 88,000
Total	\$ 2,530,000
TOTAL COST Including Upgrades and Repairs to the Existing System, \$	\$ 2,930,000

UF	O&M Cost, \$/year
Power	\$ 55,000
Chemicals	\$ 15,000
Membrane Replacement Cost	\$ 34,000
Repair and Maintenance	\$ 186,000
Total	\$ 290,000

Cloth Media Filtration	Capital Cost, \$
Sitework	\$ 10,000
Concrete	\$ -
Installed Equipment Cost	\$ 960,000
Subtotal	\$ 970,000
Finishes Allowance (2%)	\$ 20,000
I&C Allowance (3%)	\$ 30,000
Mechanical Allowance (8%)	\$ 78,000
Electrical Allowance (3%)	\$ 49,000
Total	\$ 1,147,000

Cloth Media Filtration	O&M Cost, \$/year
Power	\$ 1,000
Part Replacement Cost	\$ 41,000
Maintenance	\$ 6,000
Total	\$ 48,000

UV System with Membrane Filtration	Capital Cost, \$
Sitework	\$ -
Concrete	\$ -
Installed Equipment Cost	\$ 634,000
Subtotal	\$ 634,000
Finishes Allowance (2%)	\$ 13,000
I&C Allowance (3%)	\$ 20,000
Mechanical Allowance (8%)	\$ 51,000
Electrical Allowance (3%)	\$ 32,000
Total	\$ 750,000

UV System with Membrane Filtration	O&M Cost, \$/year
Power	\$ 66,000
Lamp, Sleeve, and Ballast Replacement	\$ 67,000
Total	\$ 133,000

UV System with Cloth Media Filtration	Capital Cost, \$
Sitework	\$ -
Concrete	\$ -
Installed Equipment Cost	\$ 1,100,000
Subtotal	\$ 1,100,000
Finishes Allowance (2%)	\$ 22,000
I&C Allowance (3%)	\$ 33,000
Mechanical Allowance (8%)	\$ 88,000
Electrical Allowance (3%)	\$ 55,000
Total	\$ 1,298,000

UV System with Cloth Media Filtration	O&M Cost, \$/year
Power	\$ 117,000
Lamp, Sleeve, and Ballast Replacement	\$ 94,000
Total	\$ 211,000

Sludge Thickening via Rotary Drum Thickener	Capital Cost, \$
Sitework	\$ 29,000
Concrete	\$ 87,000
Building	\$ 703,000
Metals	\$ 15,000
Equipment	\$ 465,000
Instrumentation & Controls	\$ 132,000
Electrical	\$ 130,000
Subtotal	\$ 1,561,000
Finishes Allowance (2%)	\$ 32,000
I&C Allowance (2%)	\$ 32,000
Mechanical Allowance (3%)	\$ 47,000
Electrical Allowance (2%)	\$ 32,000
Total	\$ 1,704,000

Sludge Thickening via Rotary Drum Thickener	O&M Cost, \$/year
Power	\$ 29,000
Polymer	\$ 17,000
Maintenance	\$ 30,000
Total	\$ 76,000

Sludge Thickening via Gravity Belt Thickener	Capital Cost, \$
Sitework	\$ 29,000
Concrete	\$ 87,000
Building	\$ 703,000
Metals	\$ 15,000
Equipment	\$ 787,000
Instrumentation & Controls	\$ 132,000
Electrical	\$ 130,000
Subtotal	\$ 1,883,000
Finishes Allowance (2%)	\$ 38,000
I&C Allowance (2%)	\$ 38,000
Mechanical Allowance (3%)	\$ 57,000
Electrical Allowance (2%)	\$ 38,000
Total	\$ 2,054,000

Sludge Thickening via Gravity Belt Thickener	O&M Cost, \$/year
Power	\$ 29,000
Polymer	\$ 20,000
Maintenance	\$ 35,000
Total	\$ 84,000

Anaerobic Digester Upgrades with CAS	Capital Cost, \$
Secondary Digester Upgrades	
Piping and Heat Exchanger	\$ 200,000
Insulation	\$ 80,000
Mixing System	\$ 130,000
Steel Cover	\$ 205,000
Subtotal	\$ 615,000
Installation	\$ 615,000
Total	\$ 1,230,000
Primary Digester Upgrades	
Primary Digester Steel Cover	\$ 125,000
Mixing System	\$ 121,000
Subtotal	\$ 246,000
Installation	\$ 246,000
Total	\$ 492,000
Project Total	\$ 1,722,000

Anaerobic Digestion with CAS	O&M Cost, \$/year
Power	\$ 13,000
Gas Cleaning and Maintenance	\$ 33,000
Total	\$ 46,000

Anaerobic Digester Upgrades with CAS+Cannibal	Capital Cost, \$
Secondary Digester Upgrades	\$ -
Piping and Heat Exchanger	\$ -
Insulation	\$ -
Mixing System	\$ -
Steel Cover	\$ -
Subtotal	\$ -
Installation	\$ -
Total	
Primary Digester Upgrades	\$ 125,000
Primary Digester Steel Cover	\$ 121,000
Mixing System	\$ 246,000
Subtotal	\$ 246,000
Installation	\$ 492,000
Total	\$ 492,000

Anaerobic Digestion with CAS+Cannibal	O&M Cost, \$/year
Power	\$ 5,000
Gas Cleaning and Maintenance	\$ 17,000
Total	\$ 22,000

Dewatering via Belt Filter Press	Capital Cost, \$
Sitework	\$ 39,000
Concrete	\$ 145,000
Building	\$ 1,025,000
Equipment	\$ 680,000
Instrumentation & Controls	\$ 157,000
Mechanical	\$ 123,000
Electrical	\$ 98,000
Subtotal	\$ 2,228,000
Finishes Allowance (2%)	\$ 45,000
I&C Allowance (2%)	\$ 45,000
Mechanical Allowance (3%)	\$ 67,000
Electrical Allowance (2%)	\$ 45,000
Total	\$ 2,430,000

Dewatering via Belt Filter Press	O&M Cost, \$/year
Power	\$ 15,000
Polymer	\$ 44,000
Maintenance	\$ 59,000
Total	\$ 118,000

Dewatering via Sludge Drying Beds	Capital Cost, \$
Sitework	\$ 100,000
HDPE Liner	\$ 408,000
Drainage System	\$ 473,000
Subtotal	\$ 981,000
Miscellaneous Allowance (10%)	\$ 98,100
Total	\$ 1,080,000

Dewatering via Sludge Drying Beds	O&M Cost, \$/year
Maintenance	\$ 41,000
Total	\$ 41,000

Dewatering via Solar Drier	Capital Cost, \$
Sitework	\$ 60,000
Concrete Slab	\$ 1,643,000
Equipment	\$ 3,300,000
Subtotal	\$ 5,003,000
Miscellaneous Allowance (5%)	\$ 251,000
Total	\$ 5,254,000

Dewatering via Solar Drier	O&M Cost, \$/year
Power	\$ 25,000
Service and Maintenance	\$ 23,000
Total	\$ 48,000

Break Tank Prior to UV System	Capital Cost, \$
Sitework	\$ 7,000
Concrete	\$ 312,000
Subtotal	\$ 319,000
Finishes Allowance (5%)	\$ 16,000
I&C Allowance (2%)	\$ 7,000
Mechanical Allowance (5%)	\$ 16,000
Electrical Allowance (2%)	\$ 7,000
Total	\$ 365,000

Upgrading Existing Zenogem with Concrete Tanks	Capital Cost, \$
Sitework	\$ 25,000
Concrete	\$ 325,000
Subtotal	\$ 350,000
Finishes Allowance (5%)	\$ 18,000
I&C Allowance (2%)	\$ 7,000
Mechanical Allowance (5%)	\$ 18,000
Electrical Allowance (2%)	\$ 7,000
Total	\$ 400,000

Appendix B
Cost Estimate Details for MBR

Headworks	Capital Cost, \$
Sitework	\$ 239,000
Concrete	\$ 860,000
Building	\$ 408,000
Metals	\$ 68,000
Equipment	\$ 3,609,000
Instrumentation & Controls	\$ 200,000
Mechanical	\$ 132,000
Electrical	\$ 90,000
Subtotal	\$ 5,606,000
Finishes Allowance (2%)	\$ 113,000
I&C Allowance (4%)	\$ 225,000
Mechanical Allowance (20%)	\$ 1,122,000
Electrical Allowance (4%)	\$ 225,000
Total	\$ 7,300,000

Headworks	O&M Cost, \$/year
Power	\$ 192,000
Maintenance (1% of the Capital Investment)	\$ 73,000
Total	\$ 265,000

Upgrading the Existing Primary Clarifiers	Capital Cost, \$
Metals	\$ 124,000
Equipment	\$ 560,000
Mechanical and Electrical	\$ 150,000
Subtotal	\$ 834,000
Finishes Allowance (2%)	\$ 12,000
I&C Allowance (2%)	\$ 12,000
Mechanical Allowance (5%)	\$ 30,000
Electrical Allowance (2%)	\$ 12,000
Total	\$ 900,000

New Primary Clarifiers	Capital Cost, \$	
Sitework	\$	194,000
Concrete	\$	500,000
Metals	\$	134,000
Equipment	\$	720,000
Mechanical and Electrical	\$	15,000
Subtotal	\$	1,561,000
Finishes Allowance (2%)	\$	63,000
I&C Allowance (4%)	\$	63,000
Mechanical Allowance (20%)	\$	157,000
Electrical Allowance (4%)	\$	63,000
Total	\$	1,910,000

Activated Sludge Basins, Mixers, and Diffuse Aeration System	Capital Cost, \$	
Sitework	\$	128,000
Concrete	\$	860,000
Metals	\$	141,000
Equipment	\$	774,000
Instrumentation & Controls	\$	242,000
Mechanical	\$	301,000
Electrical	\$	88,000
Subtotal	\$	2,534,000
Finishes Allowance (3%)	\$	77,000
I&C Allowance (5%)	\$	127,000
Mechanical Allowance (8%)	\$	203,000
Electrical Allowance (5%)	\$	127,000
Total	\$	3,068,000

MBR Process Air Blowers	Capital Cost, \$
Sitework	\$ 11,000
Concrete	\$ 28,000
Building	\$ 223,000
Equipment	\$ 412,000
Instrumentation & Controls	\$ 116,000
Mechanical	\$ 714,000
Electrical	\$ 265,000
Subtotal	\$ 1,769,000
Finishes Allowance (2%)	\$ 36,000
I&C Allowance (3%)	\$ 54,000
Mechanical Allowance (5%)	\$ 89,000
Electrical Allowance (5%)	\$ 89,000
Total	\$ 3,806,000

RAS/WAS Pump Station	Capital Cost, \$
Sitework	\$ 30,000
Concrete	\$ 98,000
Building	\$ 234,000
Equipment	\$ 453,000
Instrumentation & Controls	\$ 142,000
Mechanical	\$ 261,000
Electrical	\$ 122,000
Subtotal	\$ 1,340,000
Finishes Allowance (2%)	\$ 27,000
I&C Allowance (3%)	\$ 27,000
Mechanical Allowance (5%)	\$ 67,000
Electrical Allowance (5%)	\$ 27,000
Total	\$ 1,488,000

MBR System (Includes Activated Sludge Basins, Aeration Blowers, and RAS/WAS Pump Station, Air Scour and CIP System)	O&M Cost, \$/year
Power	\$ 512,000
Chemicals	\$ 15,000
Membrane Replacement	\$ 58,000
Maintenance (2% of the Capital Investment)	\$ 229,000
Total	\$ 814,000

UV System with MBR (Membrane Filtration)	Capital Cost, \$
Sitework	\$ -
Concrete	\$ -
Installed Equipment Cost	\$ 634,000
Subtotal	\$ 634,000
Finishes Allowance (2%)	\$ 13,000
I&C Allowance (3%)	\$ 20,000
Mechanical Allowance (8%)	\$ 51,000
Electrical Allowance (3%)	\$ 32,000
Total	\$ 750,000

UV System with MBR	O&M Cost, \$/year
Power	\$ 66,000
Lamp, Sleeve, and Ballast Replacement	\$ 67,000
Total	\$ 133,000

Sludge Thickening via Rotary Drum Thickener	Capital Cost, \$
Sitework	\$ 29,000
Concrete	\$ 87,000
Building	\$ 703,000
Metals	\$ 15,000
Equipment	\$ 465,000
Instrumentation & Controls	\$ 132,000
Electrical	\$ 130,000
Subtotal	\$ 1,561,000
Finishes Allowance (2%)	\$ 32,000
I&C Allowance (2%)	\$ 32,000
Mechanical Allowance (3%)	\$ 47,000
Electrical Allowance (2%)	\$ 32,000
Total	\$ 1,704,000

Sludge Thickening via Rotary Drum Thickener	O&M Cost, \$/year
Power	\$ 28,000
Polymer	\$ 14,000
Maintenance	\$ 30,000
Total	\$ 72,000

Sludge Thickening via Gravity Belt Thickener	Capital Cost, \$
Sitework	\$ 29,000
Concrete	\$ 87,000
Building	\$ 703,000
Metals	\$ 15,000
Equipment	\$ 787,000
Instrumentation & Controls	\$ 132,000
Electrical	\$ 130,000
Subtotal	\$ 1,883,000
Finishes Allowance (2%)	\$ 38,000
I&C Allowance (2%)	\$ 38,000
Mechanical Allowance (3%)	\$ 57,000
Electrical Allowance (2%)	\$ 38,000
Total	\$ 2,054,000

Sludge Thickening via Gravity Belt Thickener	O&M Cost, \$/year
Power	\$ 28,000
Polymer	\$ 18,000
Maintenance	\$ 35,000
Total	\$ 81,000

Anaerobic Digester Upgrades with MBR	Capital Cost, \$
Secondary Digester Upgrades	
Piping and Heat Exchanger	\$ 200,000
Insulation	\$ 80,000
Mixing System	\$ 130,000
Steel Cover	\$ 205,000
Subtotal	\$ 615,000
Installation	\$ 615,000
Total	\$ 1,230,000
Primary Digester Upgrades	
Primary Digester Steel Cover	\$ 125,000
Mixing System	\$ 121,000
Subtotal	\$ 246,000
Installation	\$ 246,000
Total	\$ 492,000
Project Total	\$ 1,722,000

Anaerobic Digestion with MBR	O&M Cost, \$/year
Gas Cleaning	\$ 30,000
Maintenance	\$ 16,000
Total	\$ 46,000

Anaerobic Digester Upgrades with MBR + Cannibal	Capital Cost, \$	
Secondary Digester Upgrades	\$	-
Piping and Heat Exchanger	\$	-
Insulation	\$	-
Mixing System	\$	-
Steel Cover	\$	-
Subtotal	\$	-
Installation	\$	-
Total		
Primary Digester Upgrades	\$	125,000
Primary Digester Steel Cover	\$	121,000
Mixing System	\$	246,000
Subtotal	\$	246,000
Installation	\$	492,000
Total	\$	492,000

Anaerobic Digestion with MBR + Cannibal	O&M Cost, \$/year	
Gas Cleaning	\$	15,000
Maintenance	\$	16,000
Total	\$	31,000

Dewatering via Belt Filter Press	Capital Cost, \$
Sitework	\$ 39,000
Concrete	\$ 145,000
Masonry	\$ 1,025,000
Equipment	\$ 680,000
Instrumentation & Controls	\$ 157,000
Mechanical	\$ 123,000
Electrical	\$ 98,000
Subtotal	\$ 2,228,000
Finishes Allowance (2%)	\$ 45,000
I&C Allowance (2%)	\$ 45,000
Mechanical Allowance (3%)	\$ 67,000
Electrical Allowance (2%)	\$ 45,000
Total	\$ 2,430,000

Dewatering via Belt Filter Press	O&M Cost, \$/year
Power	\$ 15,000
Polymer	\$ 44,000
Maintenance	\$ 59,000
Total	\$ 118,000

Dewatering via Sludge Drying Beds	Capital Cost, \$
Sitework	\$ 100,000
HDPE Liner	\$ 408,000
Drainage System	\$ 473,000
Subtotal	\$ 981,000
Miscellaneous Allowance (10%)	\$ 98,100
Total	\$ 1,080,000

Dewatering via Sludge Drying Beds	O&M Cost, \$/year
Maintenance	\$ 41,000
Total	\$ 41,000

Dewatering via Solar Drier	Capital Cost, \$
Sitework	\$ 60,000
Concrete Slab	\$ 1,643,000
Equipment	\$ 3,300,000
Subtotal	\$ 5,003,000
Miscellaneous Allowance (5%)	\$ 251,000
Total	\$ 5,254,000

Dewatering via Solar Drier	O&M Cost, \$/year
Power	\$ 25,000
Service and Maintenance	\$ 23,000
Total	\$ 48,000

Break Tank Prior to UV System	Capital Cost, \$
Sitework	\$ 7,000
Concrete	\$ 312,000
Subtotal	\$ 319,000
Finishes Allowance (5%)	\$ 16,000
I&C Allowance (2%)	\$ 7,000
Mechanical Allowance (5%)	\$ 16,000
Electrical Allowance (2%)	\$ 7,000
Total	\$ 365,000

Upgrading Existing Zenogem with Concrete Tanks	Capital Cost, \$
Sitework	\$ 25,000
Concrete	\$ 325,000
Subtotal	\$ 350,000
Finishes Allowance (5%)	\$ 18,000
I&C Allowance (2%)	\$ 7,000
Mechanical Allowance (5%)	\$ 18,000
Electrical Allowance (2%)	\$ 7,000
Total	\$ 400,000

Laguna County Sanitation District Wastewater Reclamation Plant Facilities Planning Implementation Plan

PREPARED FOR: Laguna County Sanitation District
 PREPARED BY: CH2M HILL
 DATE: January 25, 2009

Contents

Introduction and Objectives.....iii

1.0 Project Phasing..... 1-1

 1.1 Treatment Facilities Phasing..... 1-1

 1.2 Collection System Phasing..... 1-5

 1.3 Recycled Water System Phasing 1-5

2.0 Project Components, Mass Balances and Process Flow Diagram for Project Phases..... 2-1

 2.1 Phase I..... 2-1

 2.2 Phase II..... 2-6

3.0 Summary of Plant Upgrades and Cost Estimate for Project Phases 3-1

 3.1 Upgrades and Modifications for Each Project Phase 3-1

 3.2 Cost Estimates for Plant Upgrades for Project Phases 3-1

4.0 Rate Modeling and Project Financial Forecast..... 4-1

 4.1 Financial Analysis Approach..... 4-1

 4.2 Key Assumptions 4-1

 4.3 Results..... 4-3

5.0 Site Layout, Flow Conveyance, Implementation Schedule and Overall Considerations 5-1

 5.1 Site Layout and Flow Conveyance..... 5-1

 5.2 Implementation Schedule 5-4

 5.3 Other Considerations..... 5-5

Tables

1-1 LCSD WWRP Facilities Planning Priority Review of Existing Treatment Units

2-1 Flow Diversion Strategy for Low and High TDS Streams

- 3-1 Upgrade, Modification, and Expansion Needs for Phase I and Phase II of the Project
- 3-2 Cost Estimate Summary for Plant Upgrades for Phase I and Phase II
- 4-1 Allocations Between Existing and New Users for the Proposed Capital Improvements
- 5-1. Projected Plant Down town Requirements Due to Construction Activities

Figures

- 1-1 Projected Influent Flows to LCSD WWRP
- 1-2 Proposed Timeframes for Phase I and Phase II Plant Upgrades
- 1-3 Proposed Timeframe for Phase I and Phase II Plant Upgrades
- 2-1 Current Process Flow Diagram and Flow Management
- 2-2 Proposed Phase I Process Flow Diagram and Plant Upgrades
- 2-3 Process Flow Diagram and Current Flow Management
- 2-4 Phase I Mass Balance for BOD and Solids
- 2-5 Process Flow Diagram and Proposed Plant Upgrades for Phase II.
- 2-6 Phase II Flows and Mass Balance for BOD and Solids
- 5-1 Phase I Site Layout
- 5-2 Phase II Site Layout
- 5-3 Project Implementation Schedule

Introduction and Objectives

This document presents the recommended project implementation plan for Laguna County Sanitation District Wastewater Reclamation Plant facilities. A multi-criteria decision analysis was completed previously and presented in TM4. The analysis was conducted based on a monetary and a nonmonetary evaluation of the technology alternatives to identify the treatment option that would be most beneficial for LCSD. The analysis identified one conventional activated sludge (CAS) and one membrane bioreactor (MBR) alternative (Alternatives 1 and 9) as the best alternatives with virtually identical benefit to cost ratios. However, based on further evaluation of these two alternatives, and feedback from the District's Operations staff, the MBR technology (Alternative 9) was selected. The major treatment units for this MBR treatment process includes:

- Construction of activated sludge basins and membrane tanks
- Installation of a process aeration system, membrane cassettes, a membrane air scour system and ancillary membrane equipment
- Expansion of the existing UV system
- Construction of a new break tank ahead of the UV system
- Upgrade and expansion of the existing Zenogem MBR system
- Construction of a new sludge thickening facility using a rotary drum thickener
- Upgrade of existing secondary anaerobic digesters, and sludge dewatering via sludge drying beds

Due to current condition of the existing plant infrastructure, construction of a new headworks facility and two new primary clarifiers were also included in the cost analysis.

Although it was not included in benefit to cost analysis, additional cost analysis will be performed for financial modeling to include other facilities already in the Capital Improvement Planning of the District, including the new recycled water storage tanks (total of 4 in ultimate phase), an uninterrupted power source (UPS), a chlorination system to re-disinfect the long-term stored recycle water, new facilities for laboratory, garage and mechanical shop, and electrical upgrades and yard piping. The selected alternative will be further developed herein with consideration given to implementation steps such as projected flows, capacity phasing and funding.

The objectives of this implementation plan include the following:

- Establish project phasing
- Establish flow and solids mass balance, develop process flow diagram, and facility layout for the planning phases
- Identify project elements that will have impact before and during construction activities

- Develop cost estimate for the implementation plan elements and the costs for construction based on manufacturer quotes, recent project bids and market conditions
- Develop an implementation schedule

1.0 Project Phasing

1.1 Treatment Facilities Phasing

The projected average wastewater flows that will be generated within the service area of LCSD WWRP between 2010 and 2030 are illustrated in Figure 1-1 below. These flow projections are based on the Project Background TM (TM1).

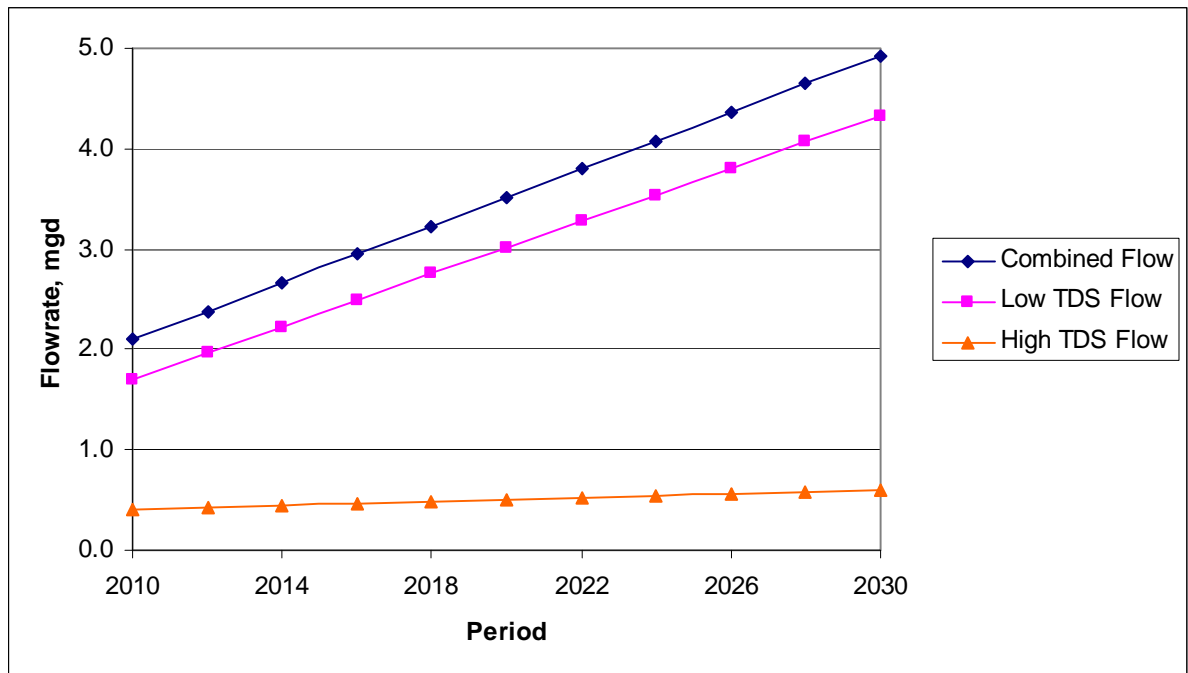

FIGURE 1-1
Projected Influent Flows to LCSD WWRP

LCSD WWRP is currently treating high and low TDS streams separately and will continue to provide separate treatment in the future, projecting that no significant increase is expected in high TDS flows in the future. The existing high TDS MBR treatment train at the WWRP is designed to treat up to 0.5 mgd flow. LCSD is planning to expand the MBR capacity to 0.6 mgd to treat additional flows that are expected in the future. Knowing that flow contribution of the high TDS stream is small compared to that of the low TDS stream, it is expected that the low TDS treatment capacity needs will be the basis for project phasing.

To aid in the project phasing evaluation, a set of criteria and scoring as presented in Table 1-1 were applied to the existing treatment units and plant facilities. The basis of the evaluation was a functionality review based on the performance, capacity and the physical condition of the existing facilities. Ultimately, any one of the unit treatment process with a corresponding 0 (zero) score was identified as a priority item that deserves immediate attention as part of facilities upgrade, whereas any unit treatment process with a score of 1 (one) or 2 (two) was identified as lower priority items, where no immediate attention is

needed to upgrade or expand these facilities. The findings of the cursory condition assessment conducted earlier under this study (TM2) were considered for this review.

Accordingly, the existing headworks, primary clarifiers and trickling filter have already approached the end of their useful lives, and priority needs to be given to replacing and/or upgrading these units. In addition, the existing trickling filter and secondary clarifier have no redundant units. The lack of redundancy raises a major concern for plant reliability and limits the operational flexibility. Therefore, priority needs to be given to replace and/or upgrade and expand the aged infrastructure and unit processes without redundant unit(s). Additionally, the plant staff has indicated that the existing ZeeWeed® Ultrafiltration system requires frequent repair and maintenance exceeding the originally anticipated routine repair and maintenance needs. These needs mainly include frequent repair of malfunctioning valves and actuators. The plant staff also indicated that the ultrafiltration trains are producing much lower filtrate flows than their projected capacities. This indicates that the capacity of the existing ultrafiltration system is actually lower than 3.2 mgd, which may require upgrade sooner than initially thought. LCSD has a plan for replacing all the membrane modules by July 2011. Replacing membranes in the ZeeWeed® Ultrafiltration System may improve productivity and restore plant capacity subjected to actual performance following completion of the upgrades. In the rate model, the existing ultrafiltration system was assumed to be replaced with MBR system under the initial phase (Phase I) upgrades. Depending upon rate model findings and project financial, the proposed replacement can be done in Phase II.

The existing sludge drying beds are not lined which has raised concerns and will likely be required to be upgraded to meet regulatory requirements. As a result, immediate action for proper lining of the sludge drying beds could be included as a priority item under this plan. LCSD will make the final decision for including this in priority item list or implementing this during Phase II upgrades.

According to Table 1-1, the upgrade and expansion of the existing high TDS MBR, high TDS RO, UV disinfection system, and anaerobic digestion can be done under the Phase II of the facilities expansion.

TABLE 1-1
 LCSD WWRP Facilities Planning Priority Review of Existing Treatment Units

Criteria	Headworks	Primary Clarifiers	Trickling Filter	Secondary Clarifier	ZeeWeed® Ultrafiltration System	High TDS MBR System	High TDS RO System	UV Disinfection	Anaerobic Digestion	Sludge Drying
Aging-Condition	0	0	0	1	1	1	2	2	1	2
Repair and Maintenance Requirement	2	1	2	2	0	2	2	2	2	2
Capacity	1	2	1	1	1	2	2	2	2	2
Performance	1	1	1	1	1	2	2	2	1	2
Reliability	1	2	0	0	2	2	2	2	2	2
Regulatory Concerns	2	2	2	1	2	2	2	2	2	0

0 = not acceptable, does not meet one or more parameters presented in the table, requires immediate attention-first priority

1 = still meets all the criteria presented in the table currently or in near future (till 2014), deserves secondary priority

2 = meets all the expectations and does not require attention in near future, deserves tertiary priority

In the light of the flow projections and Table 1-1 findings, a phasing approach was developed and presented in Figure 1-2.

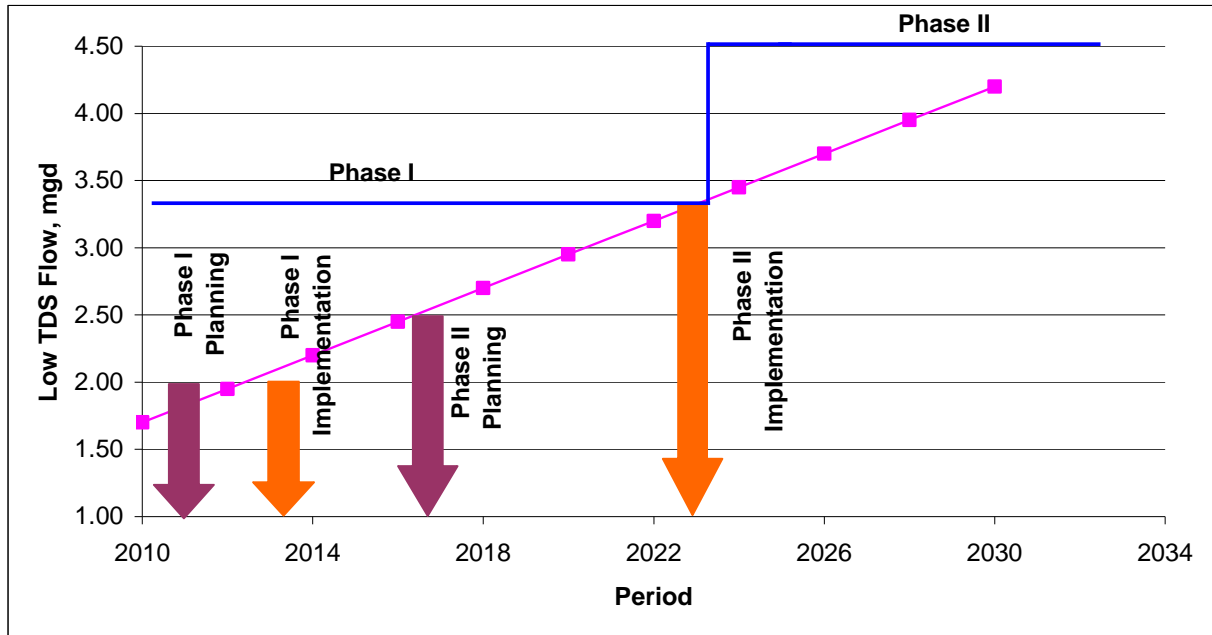

FIGURE 1-2
Proposed Timeframes for Phase I and Phase II Plant Upgrades

A two-phase approach is appropriate considering the size of the facility. As can be seen from Figure 1-2, it is suggested that the initial project phase (Phase I) activities start as early as possible. The reason for such urgency is primarily due to the need for replacing aged infrastructure and concerns related to the available capacity of the existing ultrafiltration facility as mentioned previously. According to this approach, the Initial Phase with a low TDS liquid treatment capacity of approximately 3.3 mgd (blue line in Figure 1-2) will be completed before 2014. The 3.3 mgd is the upper limit of the low TDS flow that can be treated without expanding the existing UV system capacity and was estimated using liquid treatment mass balance presented in Figure 2-4. The plant low TDS liquid capacity will be expanded to 4.5 mgd in Phase II by 2023.

According to the State Water Resources Control Board (SWRCB) guidelines, it is necessary to plan the next phase of plant expansion once 75% of the plant design capacity is reached. For the year 2017, the average low TDS flow is projected to be 2.5 mgd which is approximately 75% of the proposed Phase I capacity. The Phase II planning, therefore, needs to be started by 2017 and the necessary plant upgrades/expansions need to be completed by 2024.

A peaking factor of 2.4 (established in Project Background TM, TM1) was applied to the average flows to project the peak flows (sustained 1 to 2 hrs). Since the peak flows are equalized following the preliminary treatment and knowing that the plant has enough flow equalization capacity, these peak flows were mainly applied to size the headworks facilities. Figure 1-3 shows the projected peak flowrates and existing headworks capacity. According to Figure 1-3, the existing headworks capacity is approximately 6.0 mgd (dictated by the capacity of existing grit removal facility) that can handle the projected peak flow rates

occurring over the next three years till 2013, indicating the need for expansion. The flow rates exceeding 6 mgd will reduce retention time in grit removal chamber to a level that is not sufficient to effectively remove grit from the wastewater. Inefficient grit removal will cause grit accumulation in downstream process over the year which will reduce the effective volume of process tanks and basins. Volume reductions caused by grit accumulation are frequently observed in anaerobic digesters as anaerobic digesters are emptied for cleaning. More importantly, inadequate grit removals can damage membrane fibers and cause severe integrity problems. Therefore, both the level of aging and capacity of the grit removal systems indicate that the Phase I upgrades need to be completed by 2013, which is possible with expedited planning and scheduling.

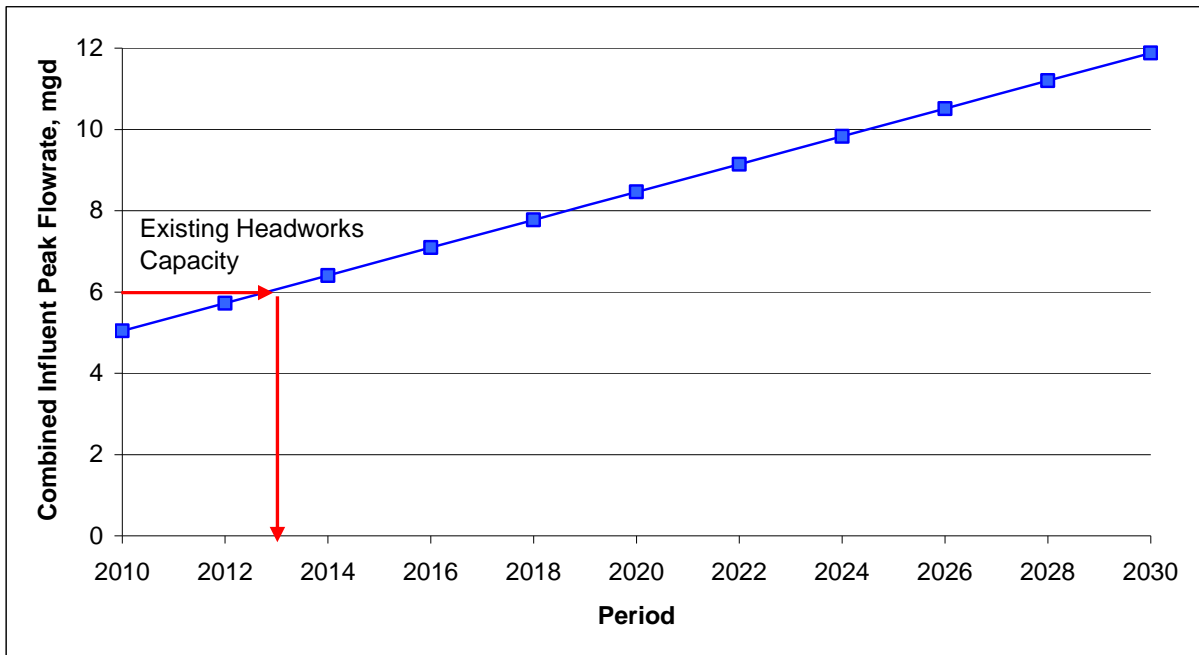

FIGURE 1-3
Proposed Timeframe for Phase I and Phase II Plant Upgrades

The phasing approach presented above was applied to the financial modeling and the results are further discussed in Section 4.

1.2 Collection System Phasing

The collection system phasing is not included in this evaluation per project scope. The collection system upgrades will be conducted per Sewer Master Plan (2007).

1.3 Recycled Water System Phasing

The recycled water average daily demand, water storage requirements and necessary acreage for row crops and/or pasture irrigation were identified and presented in a previous report titled "Feasibility Study of Treated Wastewater Discharge Options" (CH2M HILL, 2008). According to this report, LCSD will continue to produce recycled water and develop the necessary infrastructure and recycled water pipeline alignments to serve potential

customers (i.e., Santa Maria Country Club, Rancho Maria Golf Course, Sutti Farm, etc.). The infrastructure upgrades include new conveyance pipelines to the new customers, and increasing the seasonal storage capacity to 450 MG. LCSD is currently adding a 1-MG water storage tank to allow short-term storage of recycled water for high end users. It appears that most of the upgrades for the recycled water system upgrades can be implemented during Phase II treatment facility upgrades. The Class 5 estimate for recycled water system upgrades presented in Feasibility Study was \$20.6 M (according to May 2008 prices). This value included the construction costs for three 1-MG short-term storage tanks, project markups and contingencies. LCSD is currently constructing one 1-MG storage tank. Three storage tanks will be added in the future. The recycled water system cost with adjustments will be including in financial evaluation. The adjustments will consist of deduction of the storage tank cost from the Feasibility Study cost value, and addition of the three storage tank costs obtained from LCSD as one line item.

2.0 Project Components, Mass Balances and Process Flow Diagram for Project Phases

The TM 4 identified an MBR based secondary treatment technology as the most feasible treatment alternative for LCSD. One additional benefit of implementing MBR is that it can reliably meet nitrogen discharge requirements with little modifications (i.e., increasing anoxic zone volume, increasing capacity of nitrate recirculation pumps), if a portion of treated wastewater is discharged into a creek in future. LCSD is considering this discharge option to avoid costly investment of upgrading its recycle storage and distribution system. This requires NPDES to replace the existing waste discharge requirement (WDR).

As described previously, the selected alternative will include primary clarification, MBR based biological treatment (also combines membrane filtration), UV disinfection, sludge thickening, single-phase anaerobic digestion, and sludge drying beds. Based on project objectives and water quality requirements, it was determined that it is beneficial to operate WWRP with the primary clarifiers which reduce the size of the secondary treatment system and offer O&M savings due to reduced aeration requirements. The existing treatment facility has two primary clarifiers, each with a diameter of 65 ft, which have aged and require either replacing existing clarifiers with the new ones or replacing existing clarifier drives, bridges, influent risers and baffles and scraper mechanisms. Replacing primary clarifiers with the new ones is more costly but allows for combining all unit treatment processes in one new location, simplifying the plant hydraulics and enhancing flow management. The implementation plan is developed assuming replacement of the existing clarifiers.

2.1 Phase I

Currently raw sewage first enters the grit chamber and depending upon electrical-conductivity readings the flow is conveyed to either the high or the low TDS treatment train. Under low-flow conditions, when electrical conductivity readings are low, flow is routed to screening followed by primary clarification. During high flow, low TDS pond water is sent downstream of the weir whereas high TDS water is sent to the high TDS pond (all water from 5 pm to 10 pm). As high flow subsides, incoming raw wastewater goes over the weir to screen and is pumped to the primary clarifiers. Flow from the high TDS pond is treated in a separate treatment train (Figure 2-1). As can be seen from the existing process flow diagram, the current flow management in the headworks is complex.

As part of the Phase I upgrade, a new headworks facility will be built on the southeast corner of the existing treatment plant site. The new headworks facility will include an influent pump station followed by screening and grit removal facilities in sequence. The Phase I capacity of headworks will be 9.5 mgd which will handle projected peak wet weather flows until 2023. The relatively new bar screen used in the existing headworks will be relocated and used in the new structure. An additional pump will be added and one

screen (if needed) will be placed into the bypass channel to increase headworks capacity to approximately 12.0 mgd in the ultimate project phase.

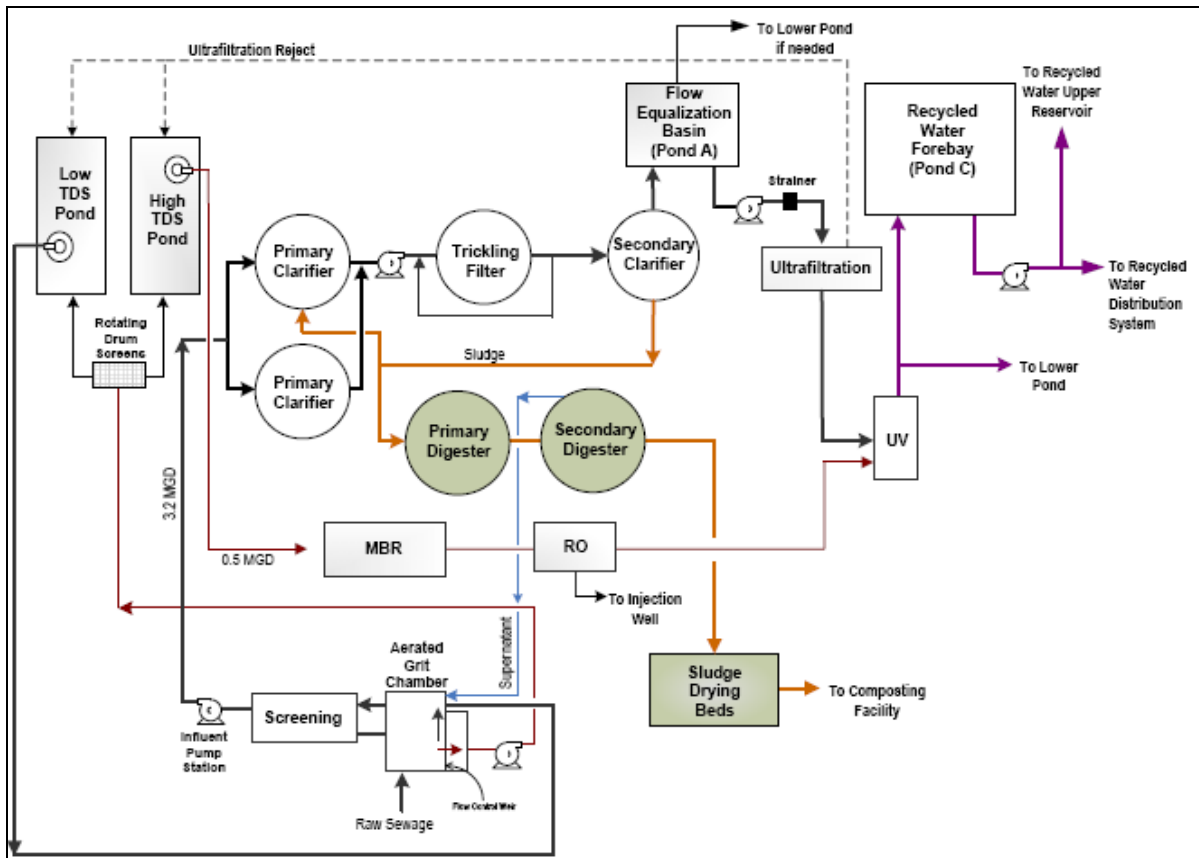

FIGURE 2-1
Current Process Flow Diagram and Flow Management

In the new headworks, all streams (either low or high TDS) will pass through screening and grit removal. An electrical-conductivity (EC) meter will be used to divert flow high and low TDS treatment trains. Table 2-1 summarizes flow diversion strategy based on EC readings and flow rates. The flow conditions will be decided using a pre-determined set point for water depth in screening or grit removal channel.

TABLE 2-1
Flow Diversion Strategy for Low and High TDS Streams

EC Reading	Flow	Action
Low	Low	Divert flow to the primary clarifiers for low TDS treatment.
Low	High	Divert flow to the low TDS ponds and subsequently return to the primary clarifiers when peak flow subsides.
High	Low	Divert flow to the high TDS pond and feed the existing Zenogem MBR system from the high TDS pond.
High	Low	Divert flow to the high TDS pond and feed the existing Zenogem MBR system from the high TDS pond.

Phase I upgrade requirements and flow management are depicted in the process flow diagram (Figure 2-2).

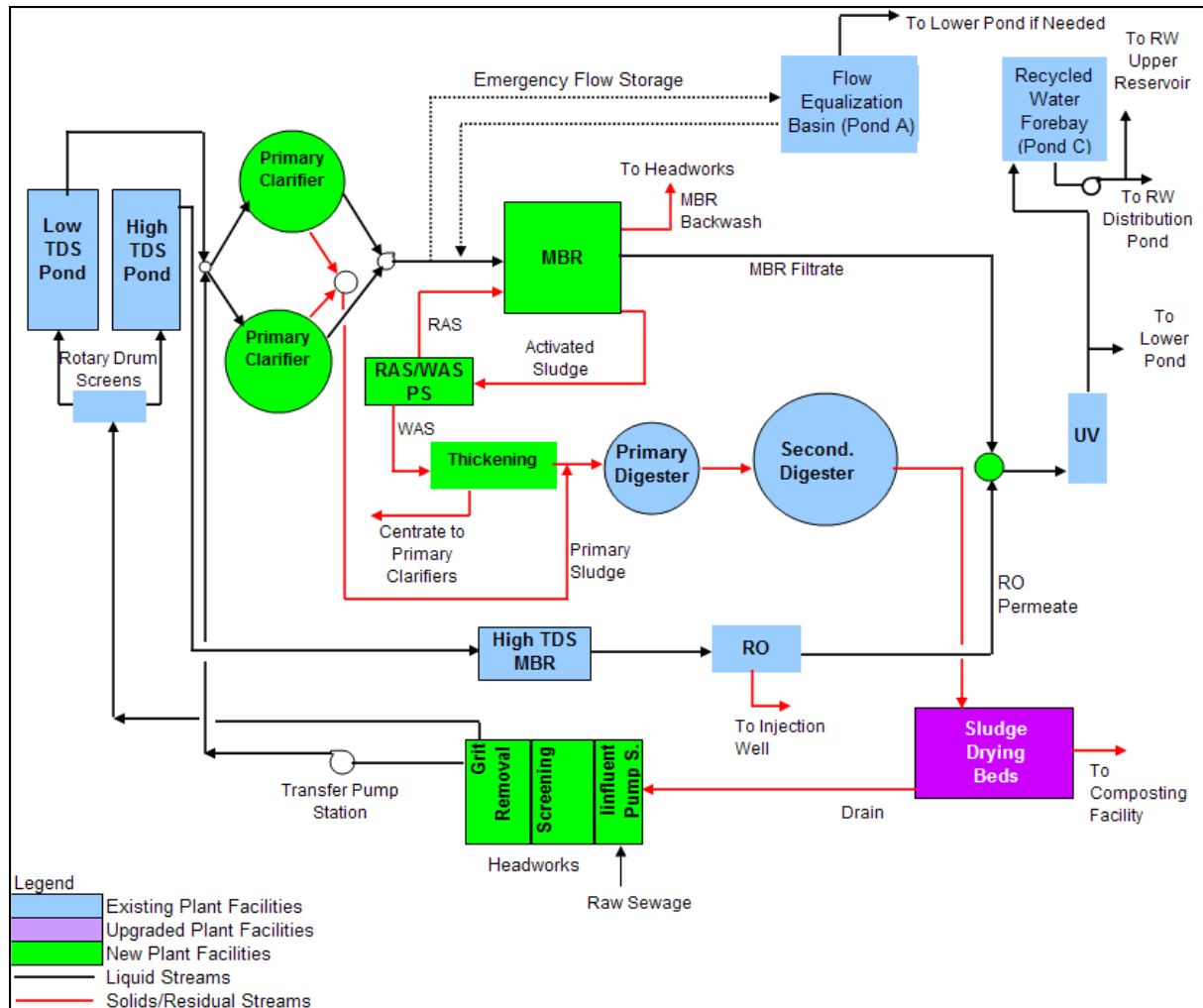

FIGURE 2-2
Proposed Phase I Process Flow Diagram and Plant Upgrades

Two new 75-ft-diameter primary clarifiers are included in Phase I plant upgrades. The sludge collected from the primary clarifiers will be blended with thickened waste activated sludge prior to anaerobic digestion. The clarified effluent from primary clarifiers will normally enter the MBR system for secondary and tertiary treatment. The flexibility is given to allow temporary storage of primary clarified wastewater in flow equalization basin (Pond A) under emergency conditions. Although it is not shown in Figure 2-1, Pond B and C can also be used to expand equalization capacity at the treatment plant. However, lining is required for using these ponds as equalization basins. The lining cost for Ponds B and C was not included in this evaluation.

The MBR system in Phase I will include activated sludge tanks and external membrane tanks, to treat an average flow of up to 3.3 mgd in the first phase and up to 4.5 mgd in the ultimate phase. Diurnal flow fluctuations will be dampened in the low TDS ponds and the MBR system itself by providing extra membrane modules. The peak flows that are not

equalized in the low TDS ponds will be equalized in the flow equalization pond (Pond A). An anoxic zone will be included in each activated sludge basin and serve as an anoxic selector to improve sludge filterability and nutrient removal. If creek discharge is considered in the near future, anoxic zone volumes and internal mixed liquor recirculation (nitrate recirculation) pump capacities should be increased to meet the nitrogen requirement. Internal mixed liquor recirculation pumps will convey nitrate-rich effluent from the end of aerobic zone to entrance section of anoxic zone to create an anoxic environment in the entrance section of activated sludge basins as presented in Figure 2-3. The return activated sludge (RAS)/waste activated sludge (WAS) pump station will deliver RAS to the head of the aeration basin and WAS to the sludge thickening. RAS pumps are designed to handle four times of the plant flowrate ($4xQ$) to avoid accumulation of solids in the membrane tanks.

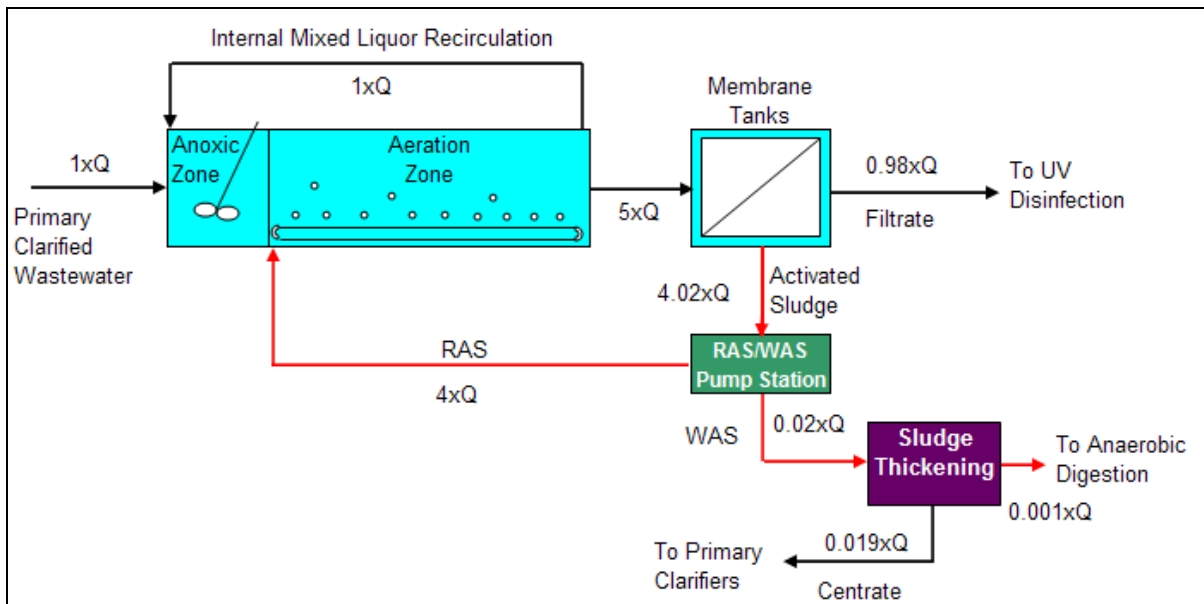

FIGURE 2-3
Process Flow Diagram and Current Flow Management

The filtrate (permeate) from MBR systems will enter a break tank prior to the UV disinfection. The sludge thickening via a rotary drum thickener will increase solids content of the sludge from about 1% to approximately 6% before the thickened sludge is sent to the anaerobic digesters. Thickening will reduce the sludge volume thereby significantly increasing the hydraulic retention time (HRT) of digestion. In addition, thickening of the sludge gives LCSD flexibility to implement anaerobic digester upgrades in Phase II. Lining of the sludge drying beds to minimize ground water contamination concerns is recommended as part of Phase I upgrades.

Solids and BOD mass balances for Phase I design flows (3.3 mgd for low TDS train and 0.5-mgd high TDS train) are presented in Figure 2-4. The proposed Phase I upgrades require LCSD to renew waste discharge requirement (WDR). The upgrade requirements for each phase are presented in Table 3-1.

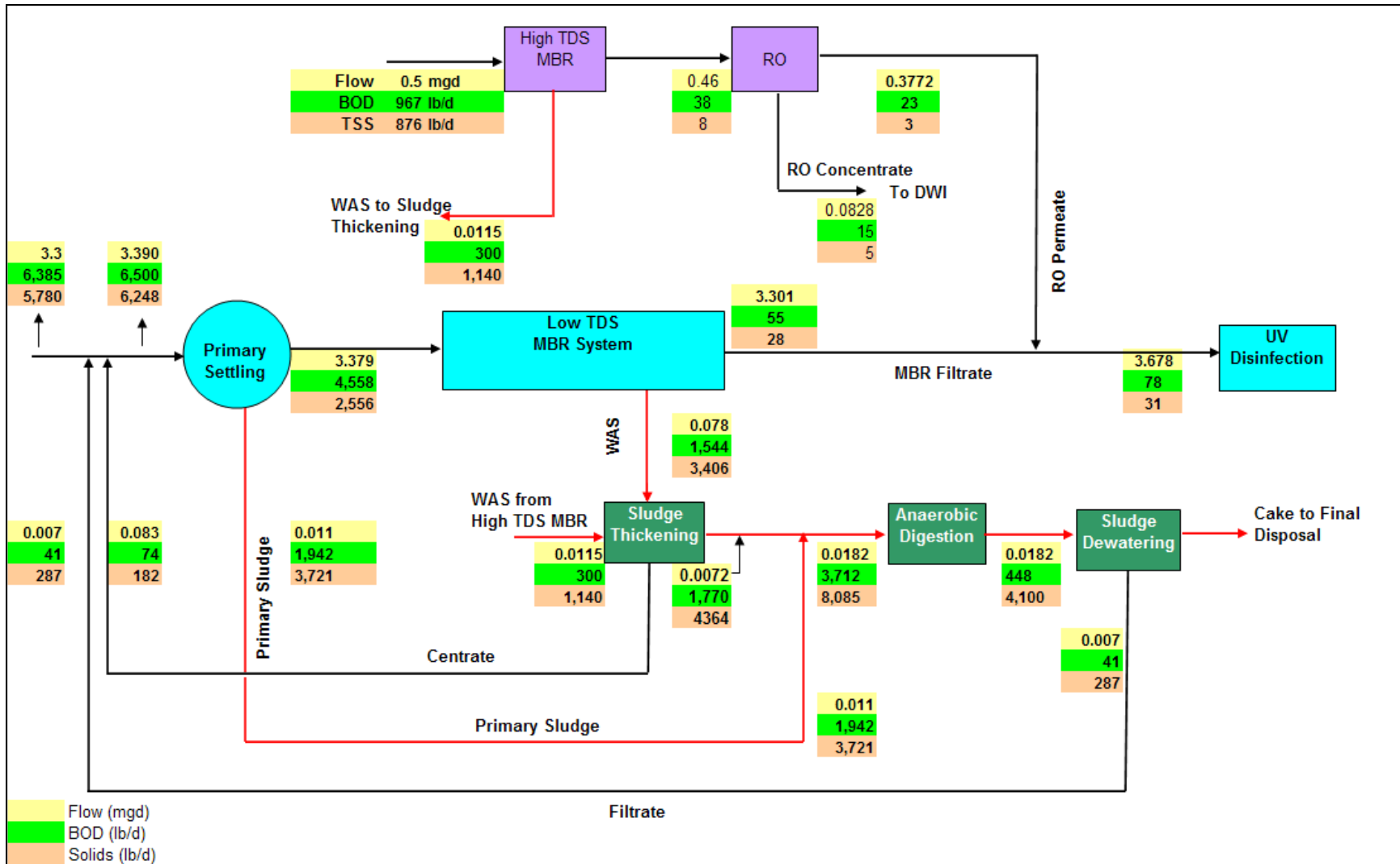

FIGURE 2-4
Phase I Mass Balance for BOD and Solids

2.2 Phase II

Because LCSD will continue to provide separate treatment for the low and high TDS streams in Phase II, the expansion and upgrade needs for low and high TDS treatment streams were estimated using design flows of 4.5 and 0.6 mgd (total of 5.1 mgd), respectively. The upgrade needs for the common treatment facilities such as UV disinfection, thickening and anaerobic digestion were estimated using combined flow from the two streams. A design peak flow rate of 12.0 mgd was used for headworks facility expansion at Phase II. The proposed upgrades for Phase II are illustrated in Figure 2-5.

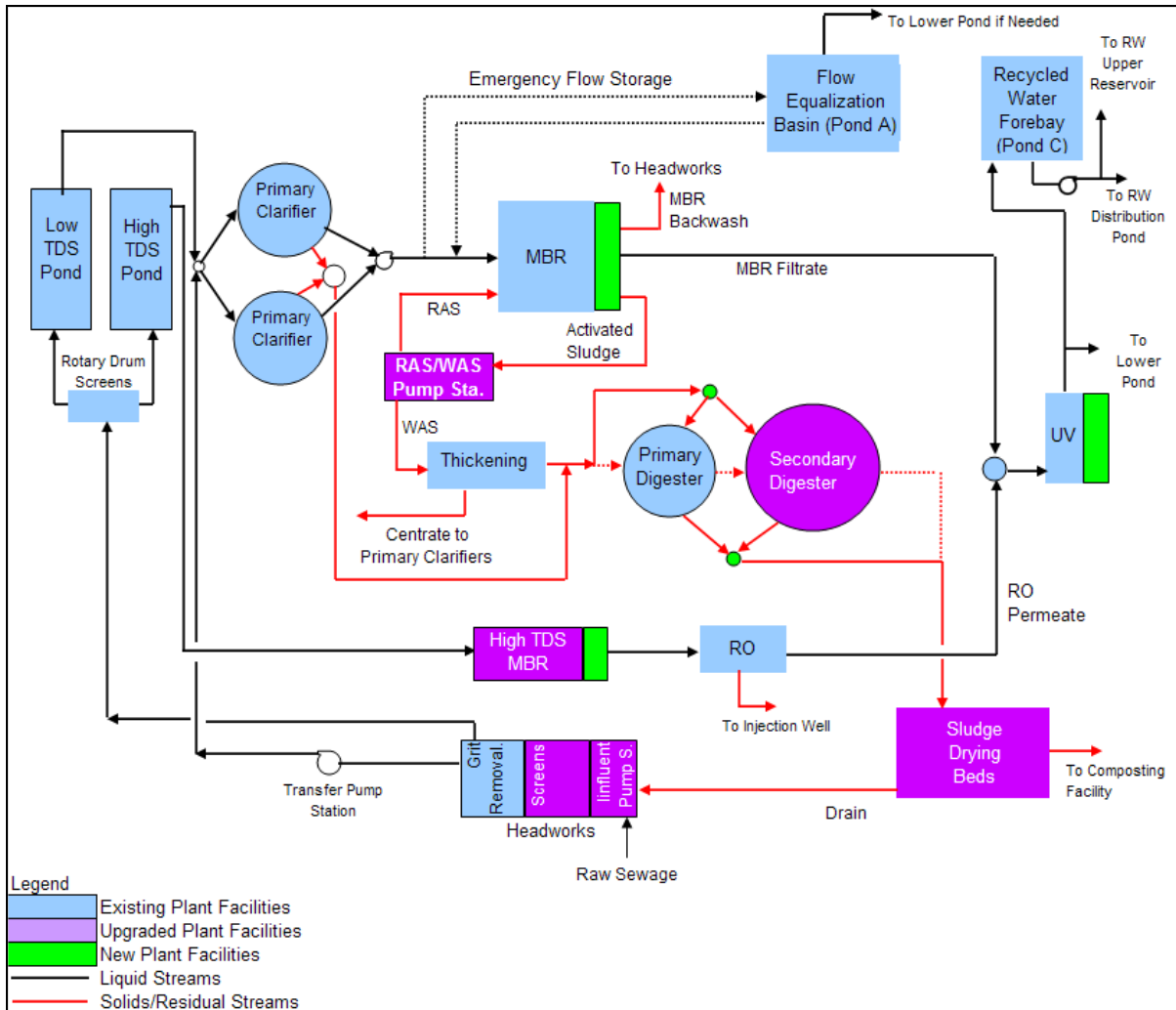

FIGURE 2-5
Process Flow Diagram and Proposed Plant Upgrades for Phase II.

According to Figure 2-5, the major upgrades for Phase II include adding new treatment trains to the low and high TDS MBR and UV facilities. The Phase II upgrades also include converting secondary digester to a primary digester by adding a mechanical mixer and heat exchanger and modifying piping arrangement to allow operation of digesters in parallel mode. New equipment will be added to increase the capacity of the headworks structure and RAS/WAS pumping station. Lining of sludge drying beds will be completed in

Phase II. A detailed summary of plant upgrades in each of the project phase is given in Table 3-1. Figure 2-6 presents design flows and solids and BOD mass balances for key liquid and solids treatment processes. The flows and mass balances are based on 0.6 and 4.5 mgd flowrates for high and low TDS liquid treatment streams.

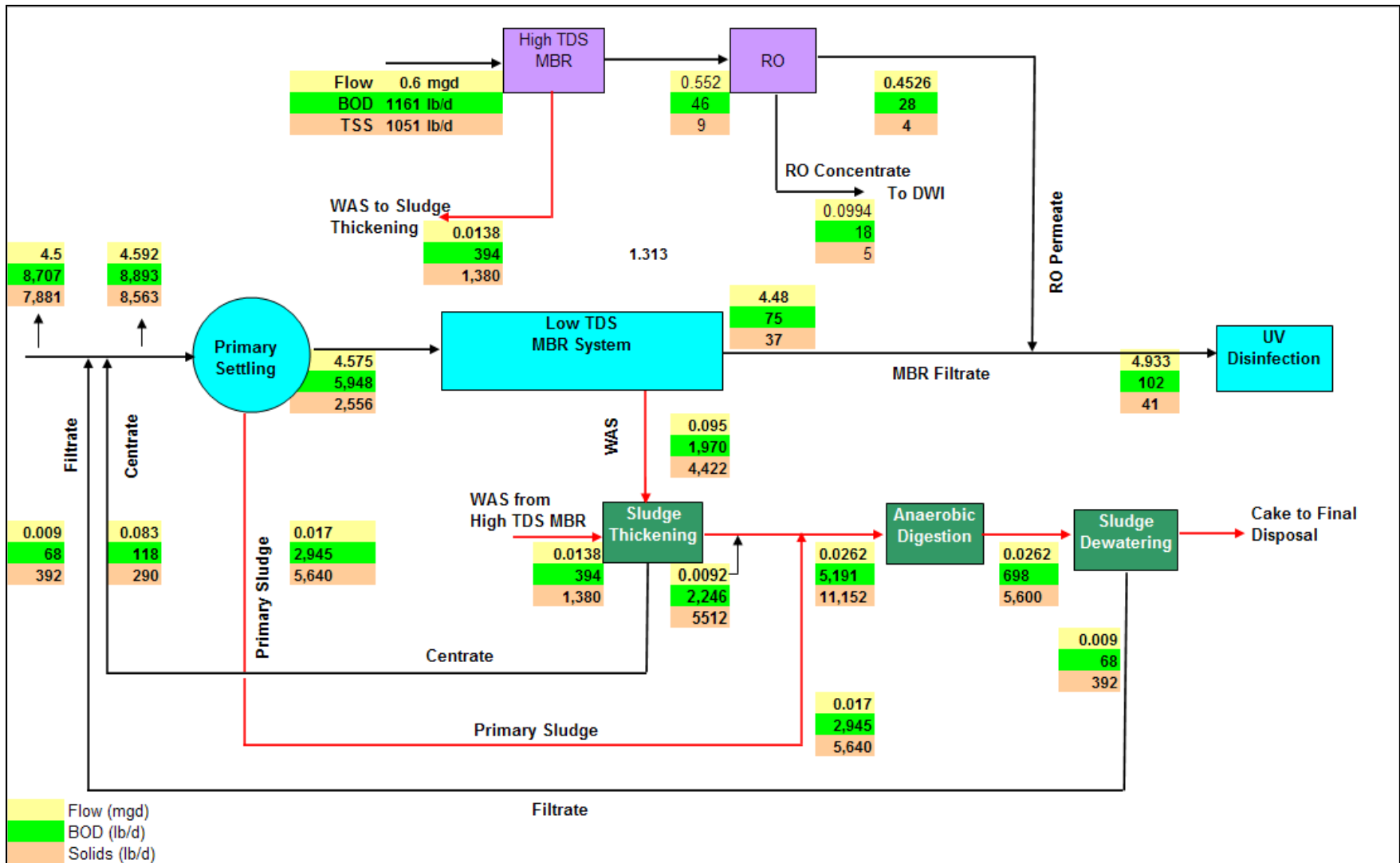

FIGURE 2-6
Phase II Flows and Mass Balance for BOD and Solids

3.0 Summary of Plant Upgrades and Cost Estimate for Project Phases

3.1 Upgrades and Modifications for Each Project Phase

The upgrade and expansion requirements were briefly discussed and illustrated in Section 2. Table 3-1 summarizes the existing facilities and upgrade needs for each phase of the project. Phase II upgrades and expansions presented in Table 3-1 are the additions to those upgrades to be already completed in Phase I.

3.2 Cost Estimates for Plant Upgrades for Project Phases

Cost estimates were developed by obtaining budgetary-level equipment costs from the equipment suppliers and calculating facility costs using CH2M HILL's cost estimating methodology (CPES) for projects of similar type and size.

The Class 5 cost estimates developed for this analysis provide a relative comparison of the treatment alternatives and are considered "order of magnitude" estimates. An order of magnitude cost estimate is defined as "an approximate estimate made without detailed engineering data." The Association for the Advancement of Cost Engineering (AACE) International defines order-of-magnitude costs as *Class 5* cost estimates without detailed engineering data. Examples of order-of-magnitude costs include: (1) an estimate from cost capacity curves, (2) an estimate using scale-up or scale-down factors, and (3) an approximate ratio estimate. The estimates shown, and any resulting conclusions on project financial or economic feasibility or funding requirements, have been prepared to guide project evaluation and implementation from the information available at the time of cost estimation. The expected accuracy ranges for a Class 5 cost estimate are -15 to -30 percent on the low side and +20 to +50 percent on the high side. The final costs of the project and resulting feasibility will depend on actual labor and material costs, competitive market conditions, actual site conditions, final project scope, implementation schedule, continuity of personnel and engineering, and other variable factors.

Capital cost, herein, reflects construction costs for the facilities and do not include engineering and design or legal fees. The following markups and contingencies were included in the facility costs:

- Mobilization: 10%
- Bond/Permits and Insurance: 3.5%
- Contractors Overheads: 15%
- Contractor Profit: 8%
- Project Contingency: 25%

TABLE 3-1
Upgrade, Modification, and Expansion Needs for Phase I and Phase II of the Project

Unit Treatment Process	Existing Facilities	Upgrade/Modification/ Expansion Needs	
		Phase I	Phase II
Headworks	Existing headworks is old (50 years) and already approached its useful life. A brand new headworks facility including influent pumps, screening and grit removal is recommended.	<p>New structure</p> <p><u>Influent Pumps:</u></p> <p>Large Pumps Number of Pumps: 2 (1 duty+1 standby) Capacity, each= 4 mgd Total Dynamic Head (TDH) = 90 Drive: Variable frequency drive (VFD)</p> <p>Small Pump Number of Pump: 1 Capacity of Pump=1.5 mgd TDH=90 ft</p> <p><u>Screening and Grit Removal:</u></p> <p>Relocate and use the existing Huber step screen and conductivity meter. Add one mechanical screen (12.5 mgd) with a bypass channel Add one grit removal with a capacity of 12.5 mgd.</p>	Add one influent pump with a capacity of 4.0 mgd.
Primary Settling Tanks	Two primary settling tanks each with a diameter of 65 ft. Condition of the primary clarifier mechanisms is bad due to significant corrosion. Concrete of primary clarifiers look OK (may require more detailed evaluation to determine condition of the concrete structure). The condition of underneath piping is unknown. Building new primary clarifiers make flow management easy and perform better treatment when one unit out of service (due to increased clarification area)	Add two new primary clarifiers with 75 ft diameter and 16 ft Side water depth (SWD).	None

TABLE 3-1
Upgrade, Modification, and Expansion Needs for Phase I and Phase II of the Project

Unit Treatment Process	Existing Facilities	Upgrade/Modification/ Expansion Needs	
		Phase I	Phase II
Flow Storage Basins	One at 2 MG (Low TDS Pond) One at 1 MG (High TDS Pond) Pond A (9 MG), B and C	None. Capacity of each basin is adequate to handle diurnal peak flows. For wet weather flows use Pond A, B and C. Connect Pond A, B and C.	None. Capacity of each basin is adequate to handle diurnal peak flows.
Activated Sludge Basins	None	Add three activated sludge basins (trains) Volume of Each Basin = 0.30 MG (approximately) Total Volume = 0.90 MG Dimension of Each Basin: Length=135 ft Width=15 ft SWD=20 ft Furnish each basin with anoxic zone, anoxic mixer, fine bubble diffuse air system and mixed liquor recycle pumps.	Add one train at 0.3 MG Dimension of Each Basin: Length=135 ft Width=15 ft SWD=20 ft Furnish the basin with anoxic zone, anoxic mixer and fine bubble air diffusers.
Aeration Blowers	None	Add 2 (1 duty+1 standby) 375 HP multi-stage centrifugal blowers for process air and mixing. Type of Blowers: Multi-stage centrifugal Capacity of Blower, each=6,000 scfm	None
MBR System (Design is based on GE-Zenon ZeeWeed® 500 d membranes)	None	Add three membrane trains (tanks) (Based on GE-Zenon 500 d membranes) Number of cassettes installed per train=5 Number of cassettes space available per train=6 Total cassettes installed=15 Number of modules installed per	Add one membrane train Number of cassettes installed per train=5 Number of cassettes space available per train=6 Total additional cassettes installed=5 Total cassettes installed (Phase I +Phase II)=20 Number of modules installed per

TABLE 3-1
Upgrade, Modification, and Expansion Needs for Phase I and Phase II of the Project

Unit Treatment Process	Existing Facilities	Upgrade/Modification/ Expansion Needs	
		Phase I	Phase II
		cassettes=48 Total number of modules installed=720 Net Flux at Average Daily Flow=12.9 gfd Each membrane tank dimension: Length=42 ft Width=11 ft SWD=13 ft Footprint of the facility: Membrane tanks: 33 ft x 47 ft Membrane permeate pumps: 48 ft x 19 ft CIP system, blowers and control panel: 48 ft x 18 ft	cassettes=48 Total additional modules installed=240 Net Flux at Average Daily Flow=12.4 gfd Total modules installed (Phase I + Phase II)=920 Each membrane tank dimension: Length=42 ft Width=11 ft SWD=13 ft Footprint of the facility (Phase I+Phase II): Membrane tanks: 44 ft x 47 ft Membrane permeate pumps: 48 ft x 19 ft CIP system, blowers and control panel: 48 ft x 18 ft
RAS/WAS/ Pump Station	None	Build a RAS/WAS Pump Station <u>RAS Pumps:</u> Add 2 (1 duty+1 standby) RAS pumps Capacity of each RAS pump= 9,800 gpm Total dynamic head (TDH), each=20 ft Drive=Variable frequency drive (VFD) <u>WAS Pumps:</u> Add 2 (1 duty+1 standby) RAS pumps Capacity of each RAS pump= 400 gpm Total dynamic head (TDH), each=25 ft Drive=Variable frequency drive (VFD)	Add 1 RAS pump with similar size.

TABLE 3-1
Upgrade, Modification, and Expansion Needs for Phase I and Phase II of the Project

Unit Treatment Process	Existing Facilities	Upgrade/Modification/ Expansion Needs	
		Phase I	Phase II
UV System	Medium pressure UV system with four banks	Add a break tank (9,300 cubic feet, 22 ft diameter, 27 ft SWD) between membrane filtration and UV disinfection system to operate UV system at nearly constant flow The rated capacity of the existing UV system is 3.7 mgd which is sufficient to treat Phase I flows.	Add two new UV banks. Upgrade electrical and control system.
Rotary Drum Thickener for WAS Thickening	None	Add one rotary drum thickener and polymer feed system. House rotary drum thickener and chemical feed system under a canopy.	None
Anaerobic Digestion	One 39 ft mesophilic digester (primary digester) One 55 ft sludge holding and decanting tank (secondary digester; no temperature or mixing provided)	None. (However, if the project budget allows, it is recommended that LCSD consider implementing Phase II upgrades at Phase I.	Convert secondary digester to primary digester by adding one 7.5 HP linear motion mixer and one spiral heat exchanger with a hot water capacity of 120 gpm.
Sludge Drying Beds	Approximately 240,000 sq-ft area available for sludge dewatering. This area is not lined.	Install HDPE liner and drain system to area of approximately 125,000 sq-ft	Install additional 60,000 sq-ft of HDPE liner and expand the drain system.
Break Tank Before UV Disinfection	None	Included under UV disinfection improvements.	Included under UV disinfection improvements.
High TDS MBR System (Zenogem)	0.5 mgd Zenogem MBR system that includes two package process trains housed in steel tanks and associated equipment and two break tanks	None	Replace existing Zenogem steel tanks with concrete tanks and add 0.1 mgd package train to handle future flows.
Yard Piping, Flow Rerouting and Electrical Upgrades for the New Plant Facilities	None	Phase I upgrades cover all major modifications (i.e., adding new piping, flow collections and distribution structures and electrical upgrades).	Sludge flow distribution and collection piping from anaerobic digesters.
Recycle Water Storage Tanks	None	One 1.0 MG steel storage tank is currently under construction. LCSD is planning to add one 1.0 MG tank as part of Phase I upgrade. Dimension of Each Tank:	Add two 1.0 MG steel storage tanks. Dimension of Each Tank: Diameter=75 ft SWD=30 ft

TABLE 3-1
Upgrade, Modification, and Expansion Needs for Phase I and Phase II of the Project

Unit Treatment Process	Existing Facilities	Upgrade/Modification/ Expansion Needs	
		Phase I	Phase II
		Diameter=75 ft SWD=30 ft	
Long-Term Recycle Water Storage and Recycled Water Distribution System	300-MG upper reservoir (lower ponds)		Expand capacity to 450-mgd. Expand recycled water distribution system per CH2M HILL report "Feasibility Study of Treated Wastewater Disposal Options" CH2M HILL May 2008). If LCSD elects to creek discharge in the future, no additional upgrade is needed for expanding storage and recycled water distribution system. Under this condition, no cost should be allocated for this upgrade.
Re-disinfect Long-term Stored Recycled Water for High End Users	None	Add a chlorination system to allow re-disinfection of long-term stored recycle water for high end users as necessary. The system will include chlorine storage, day tank and two metering pumps (one duty+one standby) for chlorine injection.	None
Backup Generator	One diesel generator (sized to run the old plant). This generator needs to be replaced considering diesel emission concerns.	Include a new natural-gas-powered generator to power essential process facilities (i.e., influent pump station, membrane air scour system, and recirculation pumps)	Expand capacity to meet Phase II power requirement.
Uninterrupted Power Supply (UPS)	None	Include a UPS system with a capacity of 20-30 kW to allow uninterrupted operation of PLCs and control systems during power surges.	Increase capacity
New Laboratory, Shop and Garage (Optional)	Existing facility has a small laboratory, shop and garage. LCSD is looking for a larger lab facility and new shop and garage	Include a new laboratory building, shop and garage. Cost is based on similar size projects.	None

Operation and maintenance cost items including chemicals, power, sludge hauling and disposal costs were calculated based on the unit costs obtained from LCSD as summarized previously in TM 3. Membrane replacement, parts replacement and maintenance costs were obtained from CPES and the equipment suppliers. A 20-year life cycle cost (LCC), which is the total cost of ownership of equipment or technology, including its cost of acquisition, operation and maintenance was estimated for each phase of the project. Table 3-2 presents capital, O&M and 20-year LCC (at 6 percent discount rate) for each phase of the project. The potential electricity purchase offset benefit due to biogas to energy was not included in the O&M cost estimates, since more upgrades in anaerobic digesters, gas treatment and handling system are necessary to realize such benefits. Due to cost and performance related concerns of LCSD, only a limited capital investment was allocated for upgrading the digestion and gas handling system and potential benefits were consequently ignored. The cost values presented in Table 3-2 were used for developing the financial models. The financial model that is summarized in Section 4 of this TM also includes recycled water sales revenues. It should be noted that implementation of creek discharge will eliminate cost associated with upgrading the recycled water storage and distribution system.

TABLE 3-2
Cost Estimate Summary for Plant Upgrades for Phase I and Phase II

	Phase I (\$)	Phase II ¹ (\$)	Phase I + Phase II ² (\$)
New Headworks Facility	5,440,000	1,860,000	7,300,000
Primary Clarifiers	1,910,000	-	1,910,000
Activated Sludge Basins	2,540,000	460,000	3,000,000
Aeration Blowers	3,806,000	-	3,806,000
MBR Tanks	5,740,000	1,867,000	7,607,000
RAS/WAS Pump Station	1,213,000	275,000	1,488,000
Break Tank Between MBR and UV System	370,000	-	370,000
Expand Existing UV System		750,000	750,000
Replace Existing Zenogem Tanks with Concrete Tanks (Rehabilitation)		400,000	400,000
Expand Existing Zenogem System for Added Salt Flow	750,000	-	750,000
Sludge Thickening via Rotary Drum Thickening	1,704,000		1,704,000
Anaerobic Digester Improvements		1,425,000	1,425,000
Dewatering Using Existing Sludge Drying Beds	730,000	350,000	1,080,000
Subtotal for Process Upgrades, \$	23,453,000	8,137,000	31,590,000
Yard Piping and Electrical (10% of the Subtotal)	2,346,000	814,000	3,160,000
Process Upgrades Total, \$	25,799,000	8,951,000	34,750,000
Other Upgrades			-

TABLE 3-2
Cost Estimate Summary for Plant Upgrades for Phase I and Phase II

	Phase I (\$)	Phase II ¹ (\$)	Phase I + Phase II ² (\$)
Recycle Water Storage Tanks	700,000	1,400,000	2,100,000
Recycled Water Distribution System	430,000	8,657,000	9,087,000
Re-disinfection of Long-term Stored Recycle Water	320,000		320,000
Emergency Power Generator System	140,000	80,000	220,000
UPS for New Plant	120,000	40,000	160,000
Garage, Shop and New Lab		700,000	700,000
Total for Other Upgrades	1,710,000	10,877,000	12,587,000
Total Capital Cost without Markups and Contingencies	28,334,000	19,003,000	47,337,000
Markups and Contingencies			
Mobilization, 10% of the Subtotal	2,834,000	1,901,000	4,734,000
Bond, Permit and Insurance, 3.5% of the Subtotal	992,000	666,000	1,657,000
Contractor Overheads, 15% of the Subtotal	4,251,000	2,851,000	7,101,000
Contractor Profit, 8% of the Subtotal	2,267,000	1,521,000	3,787,000
Project Contingency, 25% of the Subtotal	7,084,000	4,751,000	11,835,000
TOTAL CAPITAL COST, \$	45,762,000	30,693,000	76,451,000
O&M Cost³, \$/year			
Headworks, \$/year	190,000	265,000	265,000
MBR System (Includes primary clarifiers, activated sludge tanks, activated sludge system mixing and fine bubble diffuse aeration system, aeration blowers, internal mixed liquor recycle pumps, membrane tanks, membrane air scour system, CIP, RAS/WAS Pump Station)	632,000	814,000	814,000
UV System	102,000	133,000	133,000
Sludge Thickening	68,000	72,000	72,000
Anaerobic Digestion	46,000	150,000	150,000
Sludge Drying Beds	31,000	41,000	41,000
Recycle Water Distribution System (projections are based on Feasibility Study of Treated Wastewater Disposal Options, CH2M HILL May 2008)	174,000	260,000	260,000
Sludge Hauling	99,000	151,000	151,000
Total O&M Cost, \$/year	1,342,000	1,886,000	1,886,000

TABLE 3-2
 Cost Estimate Summary for Plant Upgrades for Phase I and Phase II

	Phase I (\$)	Phase II¹ (\$)	Phase I + Phase II² (\$)
Total O&M Cost Including 10% Contingency, \$/year	1,477,000	2,075,000	2,075,000
20-Year LCC, \$	62,703,000	54,493,000	100,251,000

¹ Capital cost associated with the additional upgrades/improvements that to be completed under Phase II.

² Sum of the capital costs associated with Phase I and Phase II.

³ LCSD is considering implementation of the solar power at the WWRP in the near future. When implemented, it will considerably reduce the O&M cost associated with the power.

4.0 Rate Modeling and Project Financial Forecast

The evaluation of the treatment alternatives was based on an economic analysis using a 20-year life cycle cost. This approach is appropriate for comparing alternatives, but once alternatives have been evaluated, the financial impacts of the selected alternative should be estimated. To estimate these impacts, a financial model was developed. The financial model calculates user charges for the next several years and also calculates the connection fee based on the costs allocated to new users. The financial model was developed to rapidly evaluate the financial impacts from changing capital improvements, varying rates of growth, financing costs for improvements, as well as many other financial assumptions.

4.1 Financial Analysis Approach

Unlike the life cycle cost analysis, the financial analysis is sensitive to the timing of projects. As such, there are competing goals for the utility. The key purpose of the master plan is to evaluate what facilities are needed to meet the growth estimated by the local general and community plans. As such, the master plan perspective is over the next 20 years. The financial analysis has a near term perspective – it focuses on what user charges need to be over the next few years to meet financial obligations. Therefore, if growth does not occur as soon as projected in the general plans, projects can be delayed until growth resumes.

The financial analysis is also impacted by those capital projects that are not directly influenced by the master plan decisions, and were excluded from the life cycle cost analysis. The rate model was developed to give the District the ability to vary the timing of capital costs and how they are financed, as well as varying different levels of reserves. The model allocates costs using a cost of service approach, similar to the existing model used by the District.

Capital costs are the responsibility of both existing and future users. Those improvements that are needed if there is no growth are allocated to existing users. Improvements that are needed to increase capacity for new users are allocated to new users. Many projects serve both existing and new users, and have costs shared proportionally to the capacity that is provided to each group and the benefit of the existing users. In the rate model, the capital improvements not only show when the capital costs will be incurred, but they show the allocation of costs between existing and future users. Costs allocated to existing users are recovered from user charges, while costs allocated to new users are recovered from connection fees.

4.2 Key Assumptions

While there are many inputs to the financial model that will have some impact on the user charges and connection fees, the variables with the most impact include the assumed growth rate of new development, which impacts the time of the capital improvements, and

the allocation of costs between existing and future users. In the initial analysis of the financial impacts of the master plan improvements, necessary user charge impacts would have taken place over the next few years. However, if we postponed improvements until they were needed, user charge impacts could be delayed for several years. Table 4.1 shows the allocation between existing and new users for the proposed capital improvements. It should be noted that the upgrade costs presented in Table 4-1 include contractor markups and contingencies defined in Section 3.2.

TABLE 4-1

Allocations Between Existing and New Users for the Proposed Capital Improvements

Project	Capital Improvement Plan			Total Project Cost (2010 dollars)
	Upgrade		Expansion	
	Pay-as-You-Go	Debt Servicing	Connection Fees	
Solids Handling Expansion	0%	0%	100%	0
Prim Dig Dome Replace	100%	0%	0%	212,000
Stubbs/Waller Lift Station	0%	100%	0%	1,838,900
Center Column S. Prim Clarifier	100%	0%	0%	0
Heavy Equipment Replacement	100%	0%	0%	1,487,500
Operation Building Expansion	50%	0%	50%	354,000
Major Pump Replacements	100%	0%	0%	499,400
Major Electrical Comp Replace	100%	0%	0%	337,900
Sewer System Repair/Replacement	0%	100%	0%	4,836,000
Generator Replacement	100%	0%	0%	159,000
Recycled Water Distr. Expansion Rancho Maria	0%	0%	100%	2,184,000
MBR Upgrade/Expansion				
New Headworks Facility	0%	75%	25%	11,790,000
New Two PCs (each with 75 ft)	0%	100%	0%	3,085,000
Activated Sludge Basins	0%	85%	15%	4,845,000
Aeration Blowers	0%	100%	0%	6,147,000
MBR Tanks	0%	75%	25%	12,286,000
RAS/WAS Pump Station	0%	85%	15%	2,403,000
Break Tank Between MBR and UV System	0%	100%	0%	598,000
Expand Existing UV System	0%	0%	100%	1,211,000
Replace Existing Zenogem Tanks with Concrete Tanks	0%	100%	0%	0
Expand Existing Zenogem System	0%	100%	0%	1,211,000
Sludge Thickening	0%	100%	0%	2,752,000
Anaerobic Digester Improvements	0%	0%	100%	2,302,000

TABLE 4-1

Allocations Between Existing and New Users for the Proposed Capital Improvements

Project	Capital Improvement Plan			Total Project Cost (2010 dollars)
	Upgrade		Expansion	
	Pay-as-You-Go	Debt Servicing	Connection Fees	
Dewatering Using Existing Sludge Drying Beds	0%	70%	30%	1,744,000
Yard Piping and Electrical (10% of the Subtotal)	0%	75%	25%	5,104,000
Recycle Water Storage Tanks	0%	50%	50%	3,300,000
Recycled Water Distribution System	0%	5%	95%	12,492,000
Chlorinating Stored Recycle Water	0%	100%	0%	517,000
Emergency Power Generation System	0%	60%	40%	350,000
UPS for New Plant	0%	75%	25%	256,000
Garage, Shop and New Lab	0%	0%	100%	1,131,000

4.3 Results

Based on the cost allocation shown in Table 4.1 and the value of the existing infrastructure that would be used by new users, the connection fee would need to rise to \$6,200. This increase from the existing connection fee is due to significant escalation in construction costs that was substantially greater than the consumer price index over the past several years. It also reflects costs for a new recycled water distribution system.

User charges would expect to see an increase of approximately ten percent a year for the next four years to generate the funds needed to finance construction starting in 2012-2013. There would also need to be another significant increase when the second phase of construction begins, anticipated to be 2018. A portion of these rate increases stem from having to loan funds to the capacity expansion reserves to pay for the future users' share of improvements. Slow growth results in there not being enough funds on hand in the capacity expansion reserves. Future connection fees will be used to repay the capital replacement reserve, which will offset future rate increases.

5.0 Site Layout, Flow Conveyance, Implementation Schedule and Overall Considerations

5.1 Site Layout and Flow Conveyance

Site layouts were developed for the two implementation phases of the project. The facility site layouts of the unit treatment processes in accordance with the process flow diagrams presented earlier in this TM are illustrated in Figure 5-1 and 5-2. With the exception of flow storage, equalization basins, and common unit treatment processes such as UV disinfection and anaerobic digesters, all low TDS unit treatment processes will be new and built in the southeastern corner of the existing plant site. As can be seen, from the Figures 5-1 and 5-2, the vehicles and temporary storage facilities located near the existing Zenogem MBR can be removed from the plant site and new treatment facilities will be built in those areas.

High TDS treatment processes will remain in their current location with upgrades (i.e., replacement of existing tanks, addition of a small MBR train with a capacity of 100,000 gal/day). No expansion of the UV disinfection system is required for Phase I, and it will be expanded in Phase II by adding one UV train to the existing in the current location. Existing sludge drying beds need to be lined properly to minimize groundwater contamination. The lining requirement for each phase of the project is shown in Figures 5-1 and 5-2.

Currently, pumping is the main driving force for transferring flows among the existing unit treatment processes. The target is to minimize the amount of pumping to reduce O&M cost and carbon footprint of the facility for each phase of the project. Considering flat nature of the area and the hydraulics of the treatment processes, the facility layout and cost estimates developed in this TM assume that the flow will be carried out by pumping most of the time and the cost associated with process piping was assumed as 10% of the total facility cost. Actual pipe sizes, pipe material and pumping requirements will be determined during design phase of the project. Use of gravity over pumping may offer some savings on the O&M cost and increases plant reliability. On the other hand, it will have little impact on the proposed plant site-layout which was already planned to minimize flow transfers between.



FIGURE 5-1
Phase I Site Layout



FIGURE 5-2
Phase II Site Layout

Building a new facility to replace the aging units on a separate part of the existing plant site will greatly ease construction activities and reduce plant down periods during construction. The construction of facilities that do not interfere with the current plant operation includes:

- Primary clarifiers
- Activated sludge basins
- Aeration blowers
- MBR systems (MBR tanks and all associated ancillary equipment)
- RAS/WAS Pump Station
- Sludge thickener
- Sludge drying bed lining

Table 5-1 presents unit processes that require minor to moderate shutdowns at the existing plant during plant upgrades. Actual down periods may vary depending on the availability of resources to complete the activities.

TABLE 5-1.
Projected Plant Down town Requirements Due to Construction Activities

	Projected Downtime Requirement Associated with Upgrade Activity/Phase	Reason for the Shutdowns
		Relocating the step screen and electrical conductivity meter
Headworks	Moderate/Phase I	Tie-in to the existing sewer trunk lines Tie-in to the existing low and high TDS ponds
Flow Equalization Basin	Minor/Phase I	Tie-in to flow equalization facility
Break Tank Prior to the Existing UV System	Minor/Phase I	Tie-in break tank to the existing UV system
UV System	Minor/Phase II	Flow modifications between the trains
High TDS MBR Expansion	Minor/Phase II	Flow split between old and new trains
Anaerobic Digesters	Minor/Phase II	Flow split and collection

The site layout was developed recognizing future expansion. Pipelines and conduits should be located sufficiently far away from the future structure excavations to avoid costly sheeting and shoring for the support.

5.2 Implementation Schedule

A preliminary project implementation schedule was developed for the WWRP as illustrated in Figure 5-3. For implementation of the project, the key milestone that needs to be reached is the start and completion of the preliminary design of the facilities. Preliminary design of this type of facilities satisfies the “project definition” requirements for equipment selection and permitting and environmental documentation. A quick start with very aggressive

project scheduling is essential to meet that goal. Once these steps are completed, permitting and environmental documentation, equipment selection, final design, contractor selection and construction activities can be completed. The schedule highlights a traditional design/construction delivery method that incorporates the environmental documentation. Alternative delivery methods can be implemented to shorten the Phase I schedule and bring the facilities on-line earlier than shown in Figure 5-3.

5.3 Other Considerations

The WWRP has reliable electrical power and telephone communication. The LCSD needs to contact with Pacific Gas and Electric to show the projected power consumption for future plant upgrades to determine additional transformer capacity and upgrade needs. The current emergency power generator is diesel powered and has capacity to power the current plant facilities. Considering the limited capacity and stringent current air quality requirements that prohibit use of a diesel-power generator, a new natural-gas-powered generator will be installed as part of the Phase I upgrades. In addition, control panels and communicating personal computers (PCs) will be furnished with uninterrupted power source (UPS). The WRP has currently limited water sources for lavatory use and drinking (i.e., a well and bottled water provide water for lavatory use and drinking water). The proposed WWTP upgrades, however, will not significantly increase water demand in the plant. In proposed MBR system, for instance, the cleaning of membrane (backwashing membranes) will be accomplished using produced filtrate which will be stored in a filtrate tank. WRP's distance from the residential areas significantly minimizes potential olfactory issues. Proper specification of equipment and sound-absorbing enclosures or isolation will be provided for noise control in future plant facilities (i.e., blowers, pump station). With the exception of sludge thickening and activated sludge basins, no new facility with potential odor generation will be added. To minimize odor generation, activated sludge system will be operated with sufficient dissolved oxygen (i.e., no less than 2.0 mg/L) and fresh sludge will be applied to the thickener.

Existing UV system is currently operated a typical UV dose of 200 mJ/cm² or higher according to CDPH requirements. However, current UV dose is much higher than the design UV doses (i.e., 80 mJ/cm²) stated in the NWRI UV guidelines. This high UV dose was recommended by CDPH to ensure adequate disinfection based on the outcome of the UV validation testing study performed in 2005. The flow fluctuations in ZeeWeed® system and degree of secondary treatment provided at the WRP during validation testing were the two potential factors that influenced validation testing outcome. It is expected that the proposed upgrades (i.e., a break tank ahead of UV system and better treatment with MBR) may dramatically improve UV disinfection performance and allow operation of UV system with UV doses that are expected to be at or much closer to the suggested design doses. It is recommended that LCSD communicate with CDPH to review UV operating requirements when break tank is installed. Although revalidation of the UV system may be needed by CDPH and it requires allocation of some money for the testing, the revalidated UV system may offer better value in long run in reducing O&M cost.

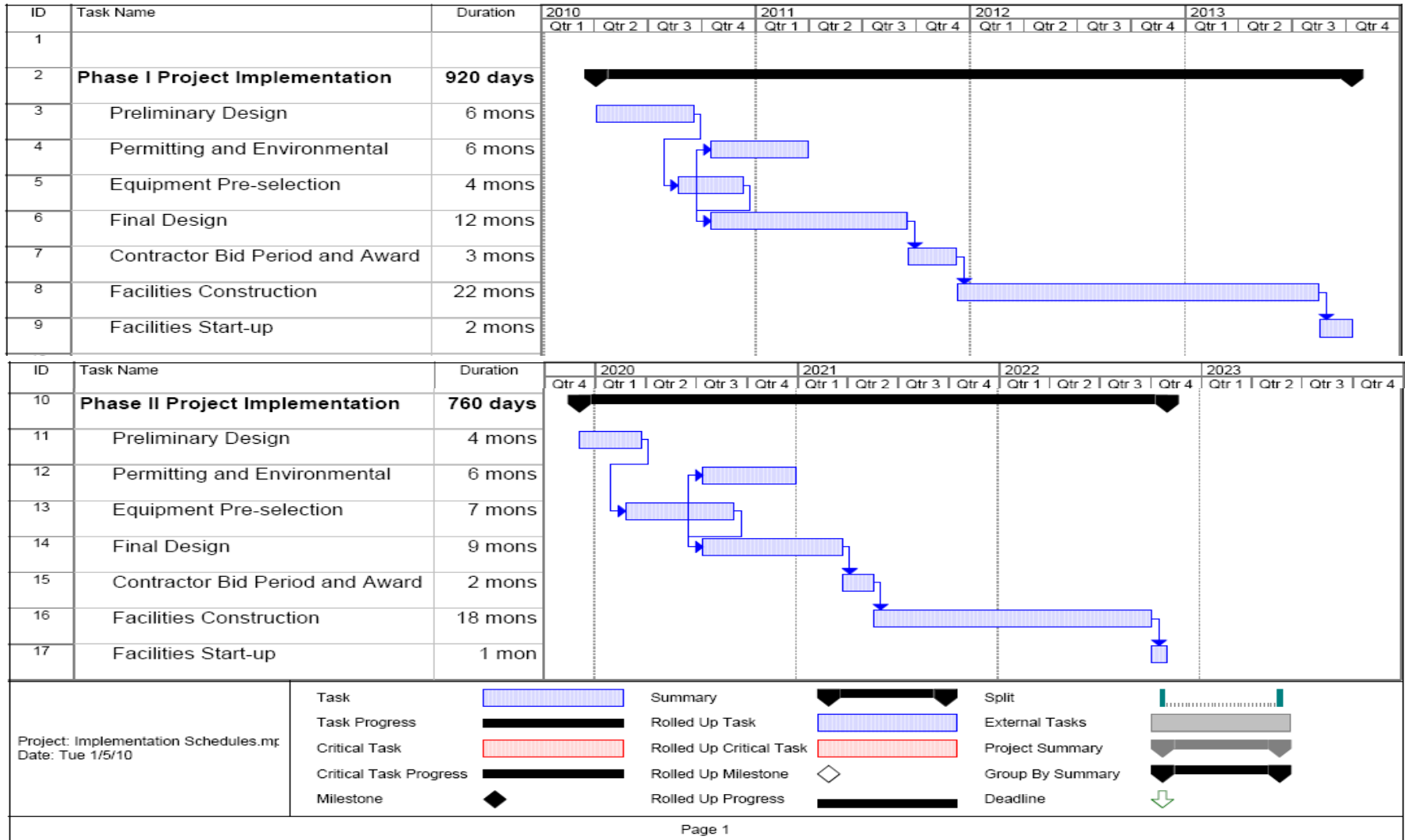

FIGURE 5-3
Project Implementation Schedule

Numerous permits (i.e., building and grading permits, floodplain analysis) may be required. For floodplain analysis, the first task is to determine whether or not the property is located in a Federal Emergency Management Agency (FEMA) designated floodplain. This can be done by reviewing the FIRMs on FEMA's Website¹. If the property is located in a FEMA designated 100-year floodplain, a floodplain study needs to be performed to assess the impacts of the project on the 100-year floodplain. This study consists of the following steps:

1. Review and research available hydrologic and hydraulic information from FEMA, USACE, City, County, and the local Flood Control District.
2. Evaluate the hydrologic information available to determine the 100-year flow rate for the affected river. If no hydrology information is available, a hydrology study will need to be performed to determine the 100-year flow rate.
3. Perform hydraulic analysis of the river for the existing and proposed project conditions. This generally consists of preparing a HEC-RAS model of the river and associated floodplain area and then running the model and evaluating the model output for the existing and proposed conditions.
4. Determine the impact, if any, on the floodplain and complete a Letter of Map Revision (LOMR), if necessary. If, based on the hydraulic analysis, physical changes to the floodplain will result due to the proposed project and they also change the flood hazard information shown on the effective FIRM, a LOMR must be requested from FEMA through the Local Floodplain Administrator. The Local Floodplain Administrator is either the City or the County, if the project is located in an unincorporated area. As soon as practicable, but not later than 6 months after the date such information becomes available, the Local Floodplain Administrator must notify FEMA of the changes by submitting technical or scientific data in accordance with 44 CFR 65.3. The request must be accompanied by the appropriate portions of the MT-2 application forms package, titled *Revisions to National Flood Insurance Program Maps* (FEMA Form 81-89 Series), and the required supporting information. In certain situations, a Conditional Letter of Map Revision (CLOMR) may also be required. It generally takes 6 to 9 months to process a CLOMR or LOMR with FEMA.

An NPDES permit is required, if creek discharge is considered in the near future. It is imperative that all of the permits be identified during the planning process and a time line and list of requirements for each be established. This will be the roadmap for project implementation.

¹<http://www.msc.fema.gov/webapp/wcs/stores/servlet/FemaWelcomeView?storeId=10001&catalogId=10001&langId=-1>

Evaluation of Current Energy and Greenhouse Gas Regulations

PREPARED FOR: Laguna County Sanitation District
PREPARED BY: CH2M HILL
DATE: July 19, 2010

The Laguna County Sanitation District (the District or LCSD) owns property near and adjacent to the wastewater reclamation plant (WWRP) that could be used to co-locate renewable energy production facilities. The District has been approached by representatives from the solar energy industry about the potential use of the land. As a high-energy user, the WWRP could benefit from alternative energy sources. To this end, the District would like to explore current regulations governing renewable energy and the potential benefits of developing alternative energy projects at the WWRP. In addition, the District is interested in any economic benefits that might be associated with a new alternative energy source.

In 2006, the California State Legislature signed the Global Warming Solutions Act (AB 32). This law requires the California Air Resources Board (CARB) to design and implement emission limits, energy regulations, and other measures such that statewide greenhouse gas (GHG) emissions are reduced in a technologically feasible and cost-effective manner to 1990 levels by 2020.

This Technical Memorandum (TM) provides an overview of GHG regulations that may affect the WWRP, based on the primary GHG emissions sources at the existing plant and estimated sources, based on the future plant recommendations described in the Wastewater Master Plan. This TM also describes the current status of California's Renewable Portfolio Standards (RPS), Renewable Electricity Standard (RES), and other relevant energy policies. This summary is intended to assist LCSD in considering its options regarding renewable energy development.

This TM focuses on GHG and energy regulations in California because California is leading the way nationally with respect to climate change and renewable energy policy. It will be important to track development of federal regulations and legislation on climate change and energy. However, it does not appear that federal policies will move forward on the same timescale that California is moving on, and California policies are likely to be more stringent and/or far-reaching. Therefore, a focus on California policy likely provides a solid framework for compliance and revenue opportunities with any federal programs that may roll out in the future.

Status of California Greenhouse Gas Regulations

Mandatory Reporting

In 2007, CARB adopted a Mandatory Reporting Regulation for GHG, and that regulation took effect in January 2009. The regulation requires facilities with combustion-related GHG emissions greater than 25,000 metric tons of carbon dioxide (CO₂) per year to report their emissions through CARB's reporting tool. Biomass emissions, or those emissions resulting from the combustion of biogases such as landfill and digester gas, count toward the threshold but are reported in a category separate from GHG. Reporting is also currently required for facilities that operate cogeneration systems that have 1-megawatt (MW) or greater power rating and emit more than 2,500 tons of CO₂ per year. Reporting facilities must have their report verified by a certified third party.

CARB is currently working on revisions to the regulation to align with the federal Mandatory Reporting Regulation (Title 40, Parts 86, 87, 89, et al., Mandatory Reporting of Greenhouse Gases, of the *Code of Federal Regulations*), adopted by the U.S. Environmental Protection Agency in 2009, and to support CARB's cap and trade program (in late 2009, CARB released its Cap and Trade Preliminary Draft Regulation, and an updated draft is imminent). Draft amendments to the Mandatory Reporting Regulation were discussed at a recent workshop in Sacramento. The changes in process with the greatest potential impacts to wastewater agencies are as follows:

- CARB is proposing to lower the reporting threshold for stationary combustion from 25,000 metric tons per year of CO₂ to 10,000 tons per year of carbon dioxide equivalent (CO₂e), including both biomass and fossil fuel emissions. This change includes using CO₂e emissions rather than CO₂ emissions for the reporting threshold.
- CARB is proposing that the verification requirements apply only to entities that have compliance obligations under California's cap and trade program (which is discussed in the next section). As currently drafted, only those facilities with fossil fuel emissions greater than 25,000 tons CO₂e per year will be subject to cap and trade; therefore, those are the only facilities that will have to pay for external verification. Agencies with emissions less than 25,000 tons per year will not be required to conduct verification.
- CARB is proposing to do away with the cogeneration category and electricity-generating facilities that are not required to report under Title 40, Part 75, of the *Code of Federal Regulations*. Therefore, if an entity currently reports because it has a cogeneration or electric generating facility that is greater than 1 MW and emits less than 2,500 tons of CO₂ per year, it will no longer have to report if its combustion emissions are less than 10,000 tons CO₂e per year. If combustion emissions are greater than 10,000 tons CO₂e per year, the entity will report as a stationary combustion source (see first bullet).

The proposed changes would begin for reporting year 2011 (to be filed in 2012). Current reporting requirements would remain through the 2010 emissions report (filed in 2011). The revised regulation is scheduled to move forward in parallel with California's cap and trade regulation, with adoption slated for October 2010.

The reporting program and the cap and trade program are focused only on combustion emissions at this time. While wastewater facilities are not specifically exempt from these

regulations, they are reporting as industrial combustion sources. GHG emissions from wastewater process units are not yet understood well enough for regulatory purposes. Research is ongoing through the Water Environment Research Foundation (WERF) and others into the emissions from wastewater process units, but further research needs to be done before these GHG emissions can be reliably reported or regulated.

More information on California's mandatory reporting program and the proposed changes is available online at <http://www.arb.ca.gov/cc/reporting/ghg-rep/ghg-rep.htm>.

Cap and Trade

On November 24, 2009, CARB released its Cap and Trade Preliminary Draft Regulation, and an updated draft is expected any day. Cap and trade is a market-based regulatory framework in which regulated entities are given "allowances" for their CO₂ emissions. To meet compliance obligations, regulated parties can reduce their own emissions, purchase allowances from other entities within the cap, or purchase "offsets" or emission reductions made by entities outside the cap.

Stationary combustion facilities that emit more than 25,000 tons of CO₂e per year would be regulated under the cap. The draft regulation contains a provision to exclude biomass emissions from compliance obligations under cap and trade, and this exclusion is expected to remain in the next draft. This means that emissions from combustion of digester or landfill gas would not count toward the threshold of 25,000 tons of CO₂e per year. Process emissions are not regulated at this time.

Offsets can be generated by facilities outside the cap, such as wastewater agencies. The offset provisions of the California cap and trade program are still being developed. In general, offsets must be as follows:

- Real – reflect actual emission reductions/removals
- Additional – beyond what otherwise have happened
- Quantifiable – reliably measured or estimated
- Verifiable – easily monitored and verifiable
- Permanent – irreversible or backed up by a guarantee
- Enforceable – backed up by contracts, legal requirements and official registration requirements

To qualify under the California program, offset projects will need to follow pre-established protocols developed by organizations such as the Climate Action Reserve or Clean Development Mechanism, or protocols developed and approved by CARB. The wastewater community (through the California Wastewater Climate Change Group) is currently working with CARB staff to identify protocols that should be developed to facilitate projects by wastewater agencies. Examples of potential protocols that CARB may develop include carbon sequestration through land application of biosolids, and fossil fuel avoidance through displacement of fossil fuel fertilizers by biosolids land application. It is important to keep in mind that just reducing GHG emissions at a facility does not generally constitute a

carbon offset. Rather, offsets are granted to specific projects developed under established protocols.

While voluntary carbon markets do exist currently, the California market will really take shape once the offset provisions of the cap and trade regulation are established. Without regulatory clarity, it is difficult to estimate the value of a compliance-based carbon offset in California until regulation is promulgated. However, one can look to the current state of the voluntary carbon markets. The best available market data from *Bloomberg New Energy Finance* (March 29, 2010) shows low price levels for voluntary emission reductions (VERs) trading in the range of \$1 to \$4 per ton of CO₂e. The low prices are attributable to the recent economic downturn and a supply glut of VERs driving down prices in the near-term horizon.

The latest information on the California draft cap and trade regulation is available online at <http://www.arb.ca.gov/cc/capandtrade/capandtrade.htm>. The public release of the final draft cap and trade regulation is planned for September 2010, with Board adoption in October. The cap and trade program would be launched in the beginning of 2012. This adoption timeframe may be delayed as a result of the intense political debate surrounding this program and AB 32 overall, but CARB staff has not indicated publicly that they will deviate from this schedule.

LCSD Emissions and Comparison to Thresholds

GHG emissions were estimated for CO₂, methane (CH₄), and nitrous oxide (N₂O) emissions, based on the methodologies and emission factors in the California mandatory reporting of GHG emissions regulation in Title 17 (Regulation), Subchapter 10, Article 2, Sections 95100 to 95133, of the *California Code of Regulations* (CCR).¹ Emissions were estimated for combustion of natural gas, digester gas, and diesel for three scenarios: current (2009), Phase I, and Phase II. Table 1 summarizes the CO₂e emission estimates; the emissions shown are much lower than the proposed reporting threshold of 10,000 metric tons of CO₂e per year; therefore, the facility would not be required to report emissions to CARB, based on the current methodologies and emission factors.

TABLE 1
Summary of Estimated Greenhouse Gas Emissions

Scenario	CO ₂ Biomass (metric tons per year)	CO ₂ e (metric tons per year)
Current	593	611.06
Phase I	973	611.24
Phase II	1,424	611.45

Note: CO₂ emissions from digester gas combustion are reported separately and not included in the CO₂e emissions.

CO₂ = carbon dioxide

CO₂e = carbon dioxide equivalent

¹ Title 17, Public Health, Division 3. Air Resources, Chapter 1. Air Resources Board, Subchapter 10 Climate Change.

Current

The natural gas, digester gas, and diesel fuel used at the WWRP in 2009 were used to estimate emissions for the current scenario. The current scenario assumes 101,129 therms per year of natural gas; 7,447 gallons of diesel fuel; and 9.1 million standard cubic feet per year (MMscf/yr) of digester gas.

Future Under Master Plan

For Phase I and Phase II, the current natural gas and diesel fuel use, along with the proposed digester gas projections, were used to estimate emissions. Phase I assumes a digester gas production rate of 14.97 MMscf/yr, and Phase II assumes a rate of 21.9 MMscf/yr. The CO_{2e} emissions slightly increase between Phase I and Phase II because only the CH₄ and N₂O from digester gas combustion would be counted toward the proposed reporting threshold of 10,000 metric tons CO_{2e}/yr.

Status of California Renewable Energy Policy

Renewable Portfolio Standard and CPUC Decision on Tradable Renewable Energy Credits

Under its existing RPS, California requires electric utilities to generate at least 20 percent of their electric power from renewable sources. Utilities must generate the renewable power themselves, or furnish renewable energy credits (RECs) that demonstrate that they have purchased renewable energy from an independent generator. Under current policy, RECs are bundled with the energy. This means that a distributed renewable power generator such as a wastewater agency must sell the energy and the REC together to the buyer. For example, if LCSD were to generate renewable energy using biogas or solar panels and use it onsite, the District would not be able to sell RECs associated with that energy. If LCSD were to sell renewable power to the grid, it would sell the power and the REC to the same electric utility under one bundled contract.

A recent proposed decision by the California Public Utilities Commission (CPUC), Decision 10-03-021, would create a market for tradable RECs. In the bundled REC case, the renewable energy generator must sell the energy and the REC to the same buyer (the electric utility); in a tradable REC case, the generator can sell the energy to the utility while selling the associated REC to any willing buyer. The buyer may be another utility or an independent broker or other third party. In a tradable REC market, LCSD could sell RECs for biogas or solar energy that it generates and uses onsite. If excess energy were generated and sold to the grid, the energy could be sold to the electric utility while the REC is sold to the highest bidder. Only new power generation added after the policy takes effect would be eligible (there would not be RECs associated with existing biogas energy facilities, for example).

The proposed CPUC decision on tradable RECs contains some controversial components. It states that no more than 25 percent of the megawatt-hours (MWh) used by the state's investor-owned utilities (IOUs)—Pacific Gas & Electric, Southern California Edison, and San Diego Gas & Electric—to meet annual procurement targets may be in the form of tradable RECs. The proposed decision also caps the price per REC for the IOUs at \$50. This usage limit and price collar would terminate at the end of 2011. The decision also defines all

out-of-state RECs as tradable RECs subject to these limitations. This decision has provoked considerable controversy related the issue of how out-of-state RECs should be treated, and outcry from IOUs on the limitations in the proposal. In light of this controversy, CPUC voted to stay the decision on May 6, 2010. CPUC proposed to go back to the drawing board to revisit the issues.

From the California wastewater perspective, the best outcome would be for a tradable REC market to be created that limits out-of-state RECs (to avoid flooding the market with cheap RECs) but not RECs generated in-state. This would enable distributed renewable energy providers such as wastewater agencies to sell their RECs to the highest bidder, yet not have the market diluted by out-of-state generators, driving down prices.

LCSD should continue to track developments on this issue and future proposals by CPUC.

Renewable Electricity Standard

In Executive Order S-21-09, California Governor Arnold Schwarzenegger directed CARB to adopt a regulation by July 31, 2010, requiring the state's energy utilities to meet a 33 percent renewable energy target by 2020. This program would be layered on top of the existing RPS. Given the higher targets, electric utilities will have increased incentive to purchase RECs, which should drive up the prices.

CARB released their Final Draft Regulation for the RES on June 2, 2010. The draft and supporting information is available online at <http://www.arb.ca.gov/regact/2010/res2010/res2010.htm>. A public hearing to consider adoption of this regulation is scheduled for July 22-23, 2010. According to the draft, under the RES, RECs can be traded or banked for up to 3 years. It will be important to track how this regulation evolves in order to understand the opportunities for LCSD with respect to revenue from renewable energy generation.

Current Value of RECs

A REC is a unique commodity that fundamentally is intertwined with the market price of non-renewable power. The price is essentially the difference between the long-term cost of producing renewable energy and the wholesale power price. One interesting conclusion from recent analysis by *Bloomberg New Energy Finance* is that, over the long run, the price of RECs should eventually fall as wholesale power prices are likely to rise over time and the cost of renewable energy falls.

As Figure 1 shows, recent scenario analysis suggests that most REC markets, including California, will achieve a peak price before 2016 (for California around \$45 per kilowatt-hour [kWh]) and then continue on a slow decline (below \$10 per kWh in California). REC prices will likely remain highly volatile in the short run. A lack of trading across markets means that a major project or imbalance in one utility's procurement could push the spot REC price to near zero or the price cap relatively quickly.

FIGURE 1
 Renewable Energy Credit Price Projections to 2030
 Source: Bloomberg New Energy Finance 2010

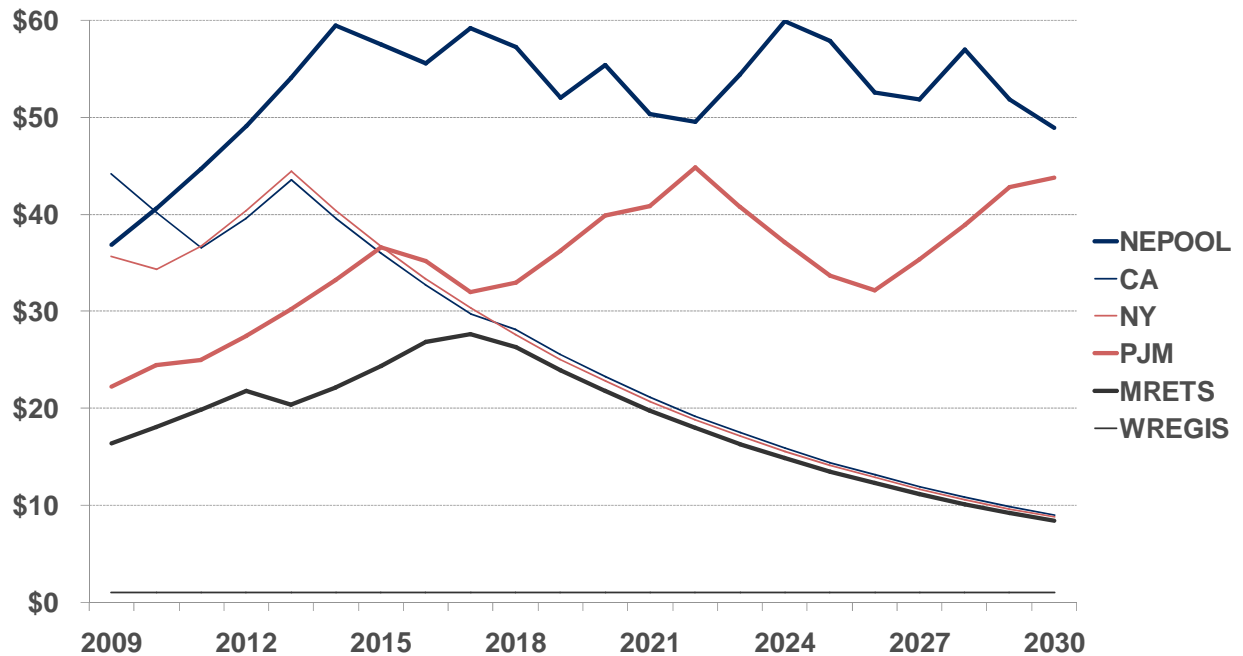

CA = California
 MRETS = Midwest Renewable Energy Tracking System (MRETS)
 NEPOOL = New England Power Pool
 NY = New York
 PJM = PJM Inc's Generation Attribute Tracking System
 WREGIS = Western Renewable Energy Generation Information

Furthermore, political and regulatory uncertainty can wreak havoc on REC prices. Policies at the federal level could boost demand for renewables, pushing REC prices up. Downside risk is associated primarily with policies or grid upgrades that could remove supply constraints on cheaper renewable in the short term. Additionally, large-scale transmission projects that cross market boundaries could flood the market and depress REC prices.

Feed-in Tariff

In Decisions 07-07-027 and 08-09-033, CPUC provided for tariffs, or standard contracts, for electric utilities' bundled purchase of RPS-eligible power generation located at public water and wastewater facilities and other customers. This "feed-in tariff" allows water and wastewater agencies to sell renewable power to the electric utility at a pre-defined premium rate. Wastewater agencies may sell to the utility either the full output of the energy generation facility (energy and RECs) or only the excess (energy and RECs) not used for onsite consumption. If an agency sells excess energy only, the RECs associated with the energy used onsite remain with the wastewater agency.

This tariff is limited to projects of not more than 1.5 MW in size and is not available for facilities that have participated in the California Solar Initiative, Self-Generation Incentive Program, or other ratepayer-funded generation incentive program.

Summary of Current Renewable Energy Funding Opportunities

Table 2 compares the various funding opportunities administered by CPUC.

TABLE 2
Renewable Energy Funding Opportunities Administered by CPUC

	Feed-In Tariffs	California Solar Initiative	Self-Generation Incentive Program	Renewable Portfolio Standard Program
Open to all renewable resources	X			X
Open to solar facilities	X	X		X
Open to wind and biogas	X		X	X
Facilities over 1.5 MW in total system size		X Rebates only for first 1 MW of generation	X Rebates only for first 1 MW of generation	X
Facilities under 1.5 MW in system size	X	X	X	
Financial Incentives Available		X Solar Only	X Wind/Biogas Only	
Renewable Energy Credits transfer to utilities per contract terms	X ***			X
Renewable Energy Credits retained by system owner		X See D.07-01-018	X See D.05-05-011	
Customers able to use "net metering" tariffs		X	X	

*** = Renewable Energy Credits transfer to the utilities only for the energy sold to the utilities. If some energy is used on site under the Net Sales approach, the applicable Renewable Energy Credits stay with the system owner.

MW = megawatts

Conclusions

The marketplaces for carbon offsets and renewable energy are rapidly evolving in California. For wastewater utilities, the renewable energy market provides more immediate opportunities than the carbon market. As LCSD contemplates its path forward with respect to developing new GHG reduction and/or renewable energy projects, it will be important to weigh the various funding and revenue opportunities, recognizing that, as policies change, the incentives and challenges may change.