

LAW OFFICE OF MARC CHYTILO, APC

ENVIRONMENTAL LAW

November 2, 2017

Mr. Steve Hudson, District Director
California Coastal Commission
South Central Coast District
89 South California Street, Suite 200
Ventura, CA 93001

By email to Steve.Hudson@coastal.ca.gov

RE: California Red-Legged Frogs in Coastal Zone at Tajiguas Landfill – Implications for Proposed Tajiguas Resource Recovery Project

Dear Mr. Hudson:

This office represents the Gaviota Coast Conservancy (GCC), a non-profit organization dedicated to preserving the environment and rural character of the Gaviota Coast. The County of Santa Barbara owns and operates the Tajiguas Landfill in a coastal canyon on the Gaviota Coast. A portion of the landfill is located within the Coastal Zone on agriculturally zoned land not authorized for landfill use. In a letter dated August 18, 2017 we alerted Commission Staff to a number of ongoing coastal permitting issues at the Landfill, as well as the proposed revision to the Tajiguas Resource Recovery Project (TRRP). Since then it has come to our attention that for the first time this year, federally threatened California red-legged frogs (CRLF) were observed in the Coastal Zone portion of the landfill. Discussed below, the TRRP may impact these protected amphibians by extending Landfill operations into the nighttime hours when adult CRLF are active, by routing project traffic adjacent to habitat utilized by CRLF and across their dispersal corridors and by extending the duration of impacts to CRLF by 8-10 additional years.

The Santa Barbara County Board of Supervisors is poised to approve a the Revised Tajiguas Resource Recovery Project (“TRRP 2.0”) on November 14th. The County is not pursuing any coastal permitting for the TRRP. The County has not analyzed the TRRP’s consistency with the Local Coastal Plan (LCP) including Coastal Land Use Plan (CLUP) policies protecting biological resources, and has not analyzed whether the TRRP may impact CRLF in the Coastal Zone. We encourage Commission Staff to weigh in at the County on this important issue and request that the County, at a minimum: 1) include all unpermitted development associated with the TRRP in the coastal zone (roads, green waste pad, grading, etc.) as part of the TRRP Project Description and process permits in accordance with the LCP (CLUP and Coastal Zoning Ordinance (CZO)); 2) perform current comprehensive surveys of all environmentally sensitive habitat and biological resources in the coastal zone portion of the Tajiguas Landfill, including CRLF; and 3) propose specific management programs, mitigation measures, restoration actions, and other actions to abate and address continuing resource damage to the natural resources in the coastal zone at Tajiguas Landfill.

LAW OFFICE OF MARC CHYTILO
P.O. Box 92233 • Santa Barbara, California 93190
Phone: (805) 682-0585 • Fax: (805) 682-2379
Email(s): marc@lomcsb.com (Marc); ana@lomcsb.com (Ana)

1. CRLF at Tajiguas Landfill

CRLF was listed federally as Threatened under the Endangered Species Act in 1996 (61 Federal Register 25813) and is a California species of special concern. Areas that support CRLF are environmentally sensitive habitat under the LCP. (See CCC Staff Report for Arco Dos Pueblos Golf Links, p. 24 – available at <https://documents.coastal.ca.gov/reports/2002/6/M6.5-6-2002.pdf>.) CRLF are present in Arroyo Quemado and Arroyo Hondo, and the Landfill is within a dispersal corridor between these two known locations. (Addendum, p. 68; available at <https://cosantabarbara.app.box.com/s/was6qpu0xz67zghryvsgzyzxethqzlmj>.) The adjacent Arroyo Quemado watershed including 2.0 acres proposed to be graded for the new ADF is part of the federally designated Critical Habitat for CRLF (Unit STB-6, included in 2010, Federal Register 12816.)

CRLF have been observed in the inland area of the Landfill site for decades. Prior to the Tajiguas Landfill Reconfiguration and Baron Ranch Restoration Project in 2009, breeding habitat existed along Pila Creek in the inland portion of the landfill. The 2009 Reconfiguration Project put Pila Creek into a culvert, and extended the landfill's waste footprint over the buried Pila Creek, which eliminated the in-channel sedimentation basins where CRLF had been breeding. 18 adult and nearly 3,000 larval and metamorph CRLFs found in the upper portion of Pila Creek were captured and translocated to Arroyo Quemado on Baron Ranch per the 2008 CRLF Management Plan required as mitigation for the Landfill Reconfiguration Project. The translocation effort was largely unsuccessful; following the translocation, numerous tagged CRLF adults returned to the Landfill site, and a year after translocation, no tagged adults were observed in Arroyo Quemado. (Exhibit 1, 2010 Baron Ranch CRLF Monitoring Report, p. 4.)

Within the Coastal Zone, Pila Creek flows through a buried concrete channel, and it was previously assumed that no aquatic habitat for CRLF existed in the Coastal Zone on the Landfill site. However, on February 13, 2017, 2 adult CRLF males were observed in the South Sedimentation Basin in the Coastal Zone, at the toe of the landfill and east of the now-buried Pila Creek. (Exhibit 2, County-FWS email, 2/14/17.) On February 20, 2017, after the County secured an amendment to its 2009 Landfill Reconfiguration Biological Opinion expanding coverage over the South Sedimentation Basin (see Exhibit 3, County email 2/14/17), one adult CRLF female was captured in the South Sedimentation Basin and translocated to Arroyo Quemado. (Exhibit 4, County-FWS email, 2/21/17.) On February 22, 2017, one adult CRLF was observed in the South Sedimentation Basin, but eluded capture. (Exhibit 5, County email, 2/23/17.) On February 27, 2017, while searching for the frog observed on February 22, 10 additional adult frogs (5 males, 4 females, and 1 juvenile) were observed in the concrete culvert/channel that the Sedimentation Basin discharges into. (Exhibit 6, County email, 2/28/17.) On April 13, 2017 another adult male – described as a “frequent flyer” that was captured in the same location on February 22nd, was observed in the vicinity of the South

Sedimentation Basin and was translocated again to Baron Ranch. (Exhibit 7, County email, 4/14/17.)

The County installed the South Sedimentation Basin in 2001 without permits or environmental review, based on the County's internal determination that the proposed sedimentation basin and associated facilities are part of the ongoing and routine landfill operations that began prior to the Coastal Act and the California Environmental Quality Act (CEQA). (Exhibit 8, Public Works Memo 1/23/01.) Note that the County has failed to secure a Vested Rights Determination under Coastal Act § 30608, despite Coastal Commission staff's direction that they do so as part of the 2002 environmental review and permitting process to define the scope of any such vested rights. (See Exhibit 4 to GCC's letter to Coastal Commission dated August 18, 2017.) The approximately 600 square foot concrete lined basin is located at the southern end of the Landfill and collects stormwater runoff from a 75-acre portion of the Landfill (with a sediment storage capacity of approximately 860 cubic feet). (*Id.*). As our August 18, 2017 letter points out, this is but one example of the County's failure to secure coastal permitting and perform environmental review for Landfill development in the Coastal Zone.

2. TRRP 2.0 Implications for CRLF

The County initially proposed to construct a new 120,100 square foot enclosed industrial trash sorting and processing facility including a Materials Recovery Facility (MRF) and Anaerobic Digestion Facility (ADF) at the Landfill. The County approved the TRRP in December 2016, but later discovered a discrepancy in the Coastal Zone boundary that disclosed that the ADF was proposed to be located partially within the Coastal Zone. After Coastal Commission Mapping Staff categorically denied the County's request for a boundary adjustment, the County sought to redesign the TRRP to avoid the Coastal Zone. TRRP 2.0 differs from the TRRP previously approved by the Board in 2016 several respects, but most notably it relocates the ADF outside of the Coastal Zone and onto the adjacent Baron Ranch, a County-owned property used for agriculture and public recreation (the Baron Ranch Trail). The County asserts that only minor changes to the Final Subsequent Environmental Impact Report (FSEIR) prepared for the TRRP are necessary to comply with CEQA, and has prepared a CEQA Addendum for the TRRP 2.0.

GCC and others have argued to the County that changed circumstances since the FSEIR's preparation require additional environmental review. The Coastal Zone boundary discrepancy is one changed circumstance that creates new potentially significant land use impacts associated with use of unauthorized Coastal Zone development. A second changed circumstance is the recent CRLF observations, both in the Coastal Zone, and at significantly increased numbers in the inland area.

The introduction of nighttime activities at the Landfill as part of the TRRP carries the potential to significantly and directly impact CRLF by nighttime vehicle and equipment operations crushing transient frogs, who typically engage in dispersal movements at night and during rainy periods. The FSEIR concluded this impact (BIO-12) is less than significant based on the low numbers of CRLF observed at the Landfill and the belief there had been removal of all breeding habitat at Pila Creek and there were no CRLF present at the South Sedimentation Basin. The 2016 FSEIR provided “removal of all breeding habitat was conducted as part of the Reconfiguration Project, and very few California red-legged frogs have been observed at the landfill since April 2012.” (FSEIR p. 4.3-42, http://resourcerecoveryproject.com/media/Final%20EIR%20Documents%20vol%201/4.3_Biological%20Resources.pdf.) Significantly, the FSEIR relied largely on its Appendix E, the Biology Technical Report, which is dated September 2013. The FSEIR assumed that “due to the disturbed and relatively barren nature of the landfill site and lack of breeding habitat, California red-legged frogs are not expected to inhabit the landfill, including proposed facility sites.” (*Id.*) The FSEIR nonetheless concluded that California red legged frogs may be present while making overland dispersal movements, which typically occur at night and/or during or following rain events, and accordingly found Impact BIO-12 to be significant but mitigable. (*Id.*)

The Mitigation Measure for CRLF (BIO-6) addresses other impacts and does not address impacts associated with the newly-discovered presence of CRLF in the southern portion of the landfill, and actually restricts night-time vehicle access to the area of the landfill south of the MRF and ADF. (*See id.*, p. 4.3-44.) The new information on CRLF locations, combined with the revisions to the TRRP necessitating additional vehicular traffic impacts CRLF survival from: 1) vehicle travelling on the main road immediately adjacent to the South Sedimentation Basin; and 2) from new vehicles transiting the CRLF’s dispersion pathways between the South Sedimentation Basin, other parts of the Tajiguas Landfill, the Pila Creek sedimentation basins, Arroyo Hondo Creek and Arroyo Quemada Creek on Baron Ranch.

Since the FSEIR was finalized in 2016, there has been a considerable increase in the number of CRLF observed at the landfill. The SEIR Addendum, dated 8/10/17 reports that in 35 focused CRLF surveys at the Landfill completed since December 2015 “a total of 21 CRLFs were observed in water/drainage features at the southern end of the Landfill and in the back canyon area of the Landfill.” (Addendum p. 69.) At least 14 of the frogs were observed in the Southern Sedimentation Basin in the Coastal Zone. (*See Exhibits 2-7.*) However, the Addendum simply concludes that because motor vehicle activity would not change with the TRRP 2.0, the “impacts on the dispersal of transient CRLF would not change relative to the prior analysis in the certified Final SEIR.” (Addendum, p. 71.) The Addendum proposes no new or changed mitigation for CRLF.

Contrary to the statement in the Addendum, recently observed CRLF in the southern portion of the Landfill will be exposed to vehicle traffic along roadways in the Coastal Zone including the current circuitous route across the Landfill face that was constructed in the Coastal

Zone in between 2003 and 2007 apparently without coastal permits or environmental review (which appears to be associated with the relocation of the green waste processing area from the inland area to the Coastal Zone during this period). (*See* Exhibit 9, Public Health Department Letter re: Amendments to JTD, attached maps.) The TRRP would extend operations at Tajiguas Landfill for 8-10 years, adding 8-10 years of new impacts to CRLF and other coastal resources. Impacts to CRLF in this area are not addressed in the FSEIR or Addendum. The CRLF Management Plan only covers the Reconfiguration Project and will cease to apply once that project is completed (*See* TRRP FSEIR p. 4.3-36.) It thus has no treatment of the TRRP's impacts upon resident and transient CRLFs.

Due to these impacts on CRLF and CRLF habitat, the TRRP 2.0 is inconsistent with the County's LCP, including (but not limited to) the following policies:

CLUP Policy 2-11, requiring that all development adjacent to ESHA "shall be regulated to avoid adverse impacts on habitat resources" and specifying that "regulatory measures include, but are not limited to, setbacks, buffer zones, grading controls, noise restrictions, maintenance of natural vegetation, and control of runoff". (CLUP p. 18)

Coastal Act § 30240 (incorporated into the CLUP via Policy 1-1, CLUP p. 11) providing that "environmentally sensitive habitat areas shall be protected against any significant disruption of habitat values, and only uses dependent on such resources shall be allowed within such areas" and that "development in areas adjacent to environmentally sensitive habitat areas and parks and recreation areas shall be sited and designed to prevent impacts which would significantly degrade such areas, and shall be compatible with the continuance of such habitat areas." (CLUP p. 116.)

CLUP Policy 9-1, requiring that all projects affecting an environmentally sensitive habitat area shall be found to be in conformity with the applicable habitat protection policies of the land use plan, and that the development and grading plans show the precise location of the habitat(s) potentially affected. (CLUP p. 120.)

3. Conclusion

While there are a number of unresolved Coastal Act issues surrounding the Tajiguas Landfill, the new information establishing the presence of CRLF in the coastal zone and direct project impacts, GCC implores the Coastal Commission to immediately communicate concerns for the CRLF and environmentally sensitive habitat to the County in advance of the November 14 hearing by the Board of Supervisors to approve the revised TRRP.

Mr. Steve Hudson, California Coastal Commission
November 2, 2017
Page 6

Sincerely,

LAW OFFICE OF MARC CHYTILO, FOR THE
GAVIOTA COAST CONSERVANCY



Ana Citrin
Marc Chytilo

Exhibits:

- Exhibit 1, 2010 Baron Ranch CRLF Monitoring Report
- Exhibit 2, County-FWS email, 2/14/17
- Exhibit 3, County email 2/14/17
- Exhibit 4, County-FWS email, 2/21/17
- Exhibit 5, County email, 2/23/17
- Exhibit 6, County email, 2/28/17
- Exhibit 7, County email, 4/14/17
- Exhibit 8, Public Works Memo 1/23/01
- Exhibit 9, Public Health Department Letter re: Amendments to JTD

CC: Jack Ainsworth, Executive Director
Shana Gray, District Supervisor, South Central Coast
Deanna Christensen, Supervising Coastal Program Analyst
Aaron McLendon, Deputy Chief of Enforcement
Molly Troup, Enforcement Analyst



Environment

Prepared for:
County of Santa Barbara
Santa Barbara, CA

Prepared by:
AECOM
Camarillo, CA

March 2011

2010 Baron Ranch California Red-legged Frog Monitoring Report



Environment

Prepared for:
County of Santa Barbara
Santa Barbara, CA

Prepared by:
AECOM
Camarillo, CA

March 2011

2010 Baron Ranch California Red-legged Frog Monitoring Report

A handwritten signature in black ink that reads "Julie Niceswanger Hickman". The signature is written in a cursive style.

Prepared By Julie Niceswanger Hickman

A handwritten signature in blue ink that reads "Wayne Vogler". The signature is written in a cursive style.

Reviewed By Wayne Vogler

Contents

1.0 Introduction.....	1
2.0 Arroyo Quemado Monitoring Methods.....	3
3.0 Results.....	4
4.0 Discussion	10
5.0 Conclusion	11
6.0 References	13

List of Tables

Table 1. California Red-legged Frogs Translocated from the Tajiguas Landfill to Arroyo Quemado in 2009	2
Table 2. Survey Conditions	4
Table 3. California Red-legged Frogs Captured and PIT-Tagged in Arroyo Quemado in 2010	5
Table 4. California Red-legged Frog Observations and Density by Survey Length	7
Table 5. California Red-legged Frog Observations in Study Pools for 2010 Winter and Summer Surveys	8
Table 6. California Red-legged Frog Capture Rates	9
Table 7. Incidental Wildlife Observations	9

List of Figures

- Figure 1. Site Location Map
- Figure 2. Arroyo Quemado Study Pools
- Figure 3. Arroyo Quemado 2010 Survey Extents
- Figure 4. Arroyo Quemado Winter 2010 Survey Results
- Figure 5. Arroyo Quemado Summer 2010 Survey Results

1.0 Introduction

The County of Santa Barbara initiated the California red-legged frog (*Rana draytonii*) translocation activities for the permitted Tajiguas Landfill Reconfiguration and Baron Ranch Restoration Project (Project) on July 25, 2009 (File No. 200801191-JSM). As part of the Project, California red-legged frogs were translocated to Arroyo Quemado on the Baron Ranch. The approved Project involves a modification (reconfiguration) of a portion of the approved and permitted waste footprint of the Tajiguas Landfill that eliminates two manmade in-channel sedimentation basins that supported a breeding population of California red-legged frogs. The reconfiguration does not change the landfill's permitted disposal capacity.

The following report summarizes the California red-legged frog monitoring activities within the Arroyo Quemado watershed on the Baron Ranch as outlined in the *California Red-legged Frog Management Plan* (ERA 2008) and the U.S. Fish and Wildlife Service *Biological Opinion* (8-8-09-F-50R) issued for the Project. This report covers Baron Ranch monitoring activities conducted from January 2010 through July 2010. The purpose of the monitoring as stated in the plan is to assess the success of the translocation efforts and the population of California red-legged frogs at Baron Ranch after the restoration activities and to assess the productivity of specific pools to determine the general health of the Baron Ranch population. A complete summary of all activities and protection measures associated with the Project are presented in the 2009 and 2010 Annual Mitigation and Monitoring Reports prepared by the County of Santa Barbara. Figure 1 depicts the general vicinity of the Baron Ranch and Arroyo Quemado watershed.

The Baron Ranch California red-legged frog monitoring surveys were conducted to monitor the population of California red-legged frogs in the southern portion of the Arroyo Quemado watershed following translocation activities at the Tajiguas Landfill and restoration activities at the Baron Ranch. Initial restoration activities within the Arroyo Quemado watershed were conducted in the summer of 2009 prior to any translocation activities. Restoration included the creation of three new pool structures within Arroyo Quemado and bank stabilization and wetland creation in two areas near the Arroyo Quemado bridge. Subsequently, in July of 2009, translocation of California red-legged frogs from the Tajiguas Landfill sedimentation basins to established pools in Arroyo Quemado was initiated and was completed by November of the same year. Fifteen pools were used for translocation activities based on their suitability to sustain California red-legged frogs and their accessibility. The three in-channel pool structures did not have adequate habitat requirements, i.e. adequate water, to function as translocation pools in 2009. Later in fall 2009, a 1.7 acre wetland restoration (seepage marsh) was also completed west of Arroyo Quemado in the area of a former quarry.

This is the first year of monitoring following the described translocation activities for the Project. This monitoring study establishes a repeatable protocol to allow a comparative analysis of the resident population and the translocated individuals to assess three goals: 1) provide a comparative analysis of the entire population as the restoration actions proceed within the watershed; 2) provide a specific protocol to assess the productivity within designated study pools; and 3) attempt to track the translocated individuals from the Tajiguas Landfill.

By repeating the monitoring protocol in subsequent years and comparing the observations, three hypothesis can be tested relative to the stated goals. The first hypothesis is that as restoration activities proceed the increased quality of upland foraging habitat will have a positive impact on the population of California red-legged frogs and an increase in the size of the population will be observed. The second hypothesis is that the translocated California red-legged frogs are now using

the Arroyo Quemado watershed. By using the first year of data and repeating the survey yearly with the established protocol, the subsequent comparative analysis can test the three hypotheses.

As individual adult frogs were translocated to Arroyo Quemado in 2009, each was injected with a passive integrated transponder tag (PIT-tag). This occurred only under the supervision of Russell Smith, who was the only biologist approved to independently PIT-tag California red-legged frogs on the Project. However, as Mr. Smith was not available for all of the subsequent Tajiguas Landfill surveys, several individual frogs were moved without being marked with PIT-tags. Photographs were taken of the patterns on the hind legs of frogs translocated but not PIT-tagged allowing for identification of returning frogs to the Tajiguas Landfill. This method however was not deemed practical for the Arroyo Quemado monitoring and was only used to identify returning individuals to the Tajiguas Landfill. Table 1 lists the PIT-tagged individuals translocated from the Tajiguas Landfill.

Table 1. California Red-legged Frogs Translocated from the Tajiguas Landfill to Arroyo Quemado in 2009

Capture Location	Capture Date	PIT-tag #	Age	Sex	SV (cm)	Wt. (g)	Relocation Site
Southern Basin	25-Jul-2009	040-106-597	A	F	11.8	194	Pool 4
Southern Basin	25-Jul-2009	040-088-316	A	F	12	154	Pool 5
Southern Basin	25-Jul-2009	040-099-859	A	F	11.5	114	Pool 5
Southern Basin	25-Jul-2009	040-067-786	A	F	11.5	134	Pool 4
Southern Basin	25-Jul-2009	040-063-330	A	F	11	186	Pool 3
Southern Basin	25-Jul-2009	040-096-625	A	M	9	110	Pool 3
Southern Basin	25-Jul-2009	040-090-823	A	M	9	128	Pool 4
Southern Basin	25-Jul-2009	040-069-545	A	M	9	126	Pool 4
Southern Basin	25-Jul-2009	040-064-528	A	F	12.5	274	Pool 5
Southern Basin	25-Jul-2009	040-073-838	A	F	13	272	Pool 3
Southern Basin	25-Jul-2009	040-066-887	A	M	9.5	118	Pool 5
Southern Basin	25-Jul-2009	040-084-545	A	F	8.9	72	Pool 5
Southern Basin	26-Jul-2009	040-094-280	A	M	9.5	132	Pool 1
Southern Basin	26-Jul-2009	040-083-545	A	M	9.5	130	Pool 6
Notes: cm = centimeters g = grams							
SV = snout to vent length Wt. = weight							
A = Adult F = Female M = Male							

2.0 Arroyo Quemado Monitoring Methods

To assess the population of California red-legged frogs in Arroyo Quemado, two sets of surveys were conducted: a winter survey and a summer survey. The winter survey was targeted during the breeding season to primarily detect adults, although first year metamorphs were also observable and recognizable during this period. The summer survey was scheduled in late July to detect tadpoles as well as juveniles and adults. Metamorphs is a term used to describe the recently metamorphosed tadpoles. Juveniles are defined as frogs that are approaching adult size but have not yet reached sexual maturity and can be the metamorphs that have survived since the last summer. However, it is difficult to assess age based on size in amphibians and these could also be small frogs that are more than a year old. Both surveys were conducted at night starting at least one-half hour after sunset. Dipnets, flashlights, headlamps, and binoculars were used to identify amphibians while walking quietly through the stream and looking under banks, boulders, and vegetation.

Surveys collected two types of locality information: a population count of all California red-legged frogs encountered and a specific study of identified pools. This study focused on the 15 pools identified for translocation activities and 1 additional pool, Pool 15, which was dry at the time of translocation but is frequently used by California red-legged frogs during the winter, spring, and early summer months. Figure 2 depicts the study pool locations within Arroyo Quemado.

Seventeen additional adult California red-legged frogs captured from the study pools were marked with PIT-tags during the January winter survey as described in the *California Red-legged Frog Management Plan*. The objective of this additional PIT-tagging was to monitor survivorship and movements of resident individuals. However after the January surveys, the U.S. Fish and Wildlife Service determined that since the translocation activities were complete and PIT-tagging had demonstrated that translocated frogs were moving back to the Tajiguas Landfill, that no additional PIT-tagging was warranted under the Project Biological Opinion (e-mail correspondence from David Simmons dated February 24, 2010). Therefore, no further PIT-tagging was conducted after the January surveys. The PIT-tagging that was completed on the resident frogs may provide some limited data regarding movement and survivorship.

For each survey, biologists recorded the start time, end time, and weather conditions. Each adult frog captured and PIT-tagged was weighed and measured. Capture and release times were recorded. In addition, the gender was determined for each frog captured. Only adults were marked with PIT-tags. When juvenile frogs were captured, the gender was typically recorded as unknown as sexual dimorphism is not distinguishable in immature frogs, and these frogs were released without tags. Mr. Smith is the only biologist on this Project who is authorized to independently PIT-tag the frogs. Mr. Smith either inserted the PIT-tags or directed Ms. Julie Niceswanger Hickman, who was also authorized to mark with PIT-tags under the supervision of Mr. Smith.

Locations of captured individuals were recorded as either a study pool location or an incidental location between the study pool locations. Adult frogs were only PIT-tagged when captured from the identified study pools. Attempts were made to capture any adult California red-legged frog encountered to determine gender and potentially its PIT-tag number.

3.0 Results

Surveys were conducted January 27, 28 and 29, March 9, and April 26, 2010 for the winter survey. Surveys were conducted July 20, 21, and 22, 2010 for the summer survey. Figure 3 depicts the survey extents for the winter and summer surveys. Survey conditions and personnel are summarized in Table 2. No significant physical changes in the designated study pools were observed from the initial establishment in fall of 2009. In addition to the 14 translocated California red-legged frogs PIT-tagged in 2009, 17 individuals were PIT-tagged from Arroyo Quemado during the January survey period. Information detailing the PIT-tag number and location of capture is detailed in Table 3. For purposes of this study, additional individuals PIT-tagged from Arroyo Quemado are referred to as resident frogs as compared to translocated frogs.

A repeat observation of one previously PIT-tagged resident California red-legged frog was made during the January survey. The March survey repeated a previously surveyed area and two previously PIT-tagged resident California red-legged frogs were recaptured during the March survey (Table 3). The individual captured during the January survey was found in study pool 5; its original capture pool. One of the individuals captured during the March survey was found in its original capture pool (pool 3) and the other was recaptured in the next closest pool downstream from the original capture pool. No translocated California red-legged frogs from the Tajiguas Landfill were recaptured during 2010 monitoring surveys in Arroyo Quemado.

Table 2. Survey Conditions

Date	Authorized Biologist*	Survey Time	Weather Conditions: Temperature, Wind, Cloud cover
27-Jan-2010	RS, JN, RC, WV, CD	20:00-23:30	50°F, calm, clear
28-Jan-2010	RS, JN, CD	19:00-22:45	54°F, calm, 10-15% clouds
29-Jan-2010	RS, JN, CD, RC	18:00-23:00	43°F, calm, clear
09-Mar-2010	RS, JN,	19:00-23:00	52°F, 5-10 mph, clear
26-April-2010	JN, AB, CR, MC, SH	21:00-23:15	58°F, calm, clear
20-Jul-2010	RS, JN	20:30-23:45	58°F, calm, clear
21-Jul-2010	RS, JN	20:30-00:30	58°F, calm, clear
22-Jul-2010	RS, JN	20:30-00:00	60°F, calm, clear
*AB – Adam Backlin, USGS, CD – Carl Demetropoulos, AECOM, CR – Carlton Rochester, USGS, JN – Julie Niceswanger Hickman, AECOM, MC – Mark Canfield, USGS, RC – Rob Conohan, AECOM, RS – Russell Smith, AECOM, SH – Stacie Hathaway, USGS, WV – Wayne Vogler, AECOM			Notes: °F = degrees Fahrenheit mph = miles per hour

Table 3. California Red-legged Frogs Captured and PIT-Tagged in Arroyo Quemado in 2010

Capture Location	Capture Date	PIT-tag Number	Age	Sex	SV (cm)	Wt. (g)	Recapture Date	Recapture Location	
Baron Pool 5	22-Oct-2009	040-082-097	A	F	-	194	20-Jul-2010	Baron Pool 5	
Baron Pool 5	27-Jan-2010	040-060-048	A	F	9.0	74	-		
Baron Pool 5	27-Jan-2010	040-086-846	A	F	10.0	116	-		
Baron Pool 8	27-Jan-2010	040-093-018	A	F	7.5	70	-		
Baron Pool 11	27-Jan-2010	040-099-020	A	M	8.5	65	-		
Baron Pool 12	27-Jan-2010	040-106-309	A	F	8.5	63	-		
Baron Pool 11	28-Jan-2010	040-097-023	A	F	8.0	50	-	-	
Baron Pool 13	28-Jan-2010	040-083-081	A	F	7.0	50	-		
Baron Pool 13	28-Jan-2010	040-081-125	A	F	9.0	65	-	-	
Baron Pool 13	28-Jan-2010	040-080-015	A	F	8.0	62	-	-	
Baron Pool 15	28-Jan-2010	040-623-827	A	M	9.5	82	-	-	
Baron Pool 3	29-Jan-2010	040-613-288	A	F	10.5	136	09-Mar-2010*	Baron Pool 3	
Baron Pool 3	29-Jan-2010	040-599-792	A	F	11.5	146	09-Mar-2010*	Baron Pool 4	
Baron Pool 3	29-Jan-2010	040-626-280	A	F	10.5	90	-	-	
Baron Pool 4a	29-Jan-2010	040-611-541	A	F	9.0	76	-	-	
Baron Pool 4b	29-Jan-2010	040-630-022	A	F	8.0	64	-	-	
Baron Pool 7	29-Jan-2010	040-609-365	A	F	7.5	64	-	-	
*Repeat of Winter Survey pools during Winter Survey. Frogs marked during Winter Survey recaptured during Winter Survey.					Notes: SV = snout to vent length cm = centimeters Wt. = weight g = grams A = Adult F = Female M = Male				

All California red-legged frogs observed were recorded during each survey. Figures 4 and 5 depict the observation results for winter and summer surveys respectively. Table 4 presents a summary of the survey extents and the number of frogs observed within each extent. A total of 49 adults, 5 juveniles and 22 metamorphs were observed during the winter surveys. Summer survey observations were higher for adults and juveniles with a total of 71 adults and 22 juveniles observed however, only 4 metamorphs were observed. Tadpoles were observed in two pools; pool 4 and an incidental pool between pools 1 and 6 during the summer survey. The highest density of frogs during the winter survey was recorded during the March survey within the survey extent between Pool 6 and Pool 1. The highest density of frogs during the summer survey was recorded during the July 22, 2010 survey within the survey extent between Pool 6 and Pool 1. Additionally, the area between the Arroyo Quemado Bridge and Pool 4 also had a high density of frogs. There was a higher observable density of adult frogs observed within Arroyo Quemado during the summer months than the winter months however the difference is not considered statistically significant (t-test *p-value* = 0.11). Statistically significant results are assumed to have a t-test *p-value* equal to 0.05 or less.

The number of individuals observed in each study pool is presented in Table 5. The highest number of adult and juvenile frogs was observed in Pool 4a/b during the summer survey where a combined total of 11 frogs were observed. Pool 1 also had a high number of frogs with a combined total of 7 adult and juvenile frogs recorded. Additionally, during the winter survey 5 frogs were observed in Pool 1. The difference in the numbers of frogs recorded in the study pools was not statistically significant between the survey periods (t-test *p-value* = 0.36).

The frogs classified as juvenile are individuals that have not yet reached sexual maturity and could also be called sub-adults. They appear smaller than the average adult frogs and do not demonstrate any observable characteristics to distinguish their gender. Individuals in this classification are likely less than a year old and may be metamorphs from the previous year. As previously stated immature frogs may also be older than a year due to slower growth rates. Juveniles were only recorded from one study pool during the winter survey, Pool 2. The summer survey yielded several pools where juveniles were recorded (Table 5).

Capture rates are presented in Table 6 for both survey seasons. Surveyors captured an average of 58% of the frogs observed during the winter surveys and an average of 53% of the frogs observed during the summer surveys. Although the percentages for capture are variable by season the difference in seasons is not considered statistically significant (t-test *p-value* = 0.37).

Table 4. California Red-legged Frog Observations and Density by Survey Length

Survey Season	Date	Survey Length (feet)	California Red-legged Frogs Observed				Density of Adults & Juveniles Distance/# frogs
			Adults	Juveniles	Metamorphs	Tadpoles	
Winter	27-Jan-2010	1470	12	0	4	0	1 frog every 122 feet
	28-Jan-2010	1696	10	0	9	0	1 frog every 169 feet
	29-Jan-2010	1888	11	0	3	0	1 frog every 172 feet
	09-Mar-2010*	1093	8	0	6	0	1 frog every 137 feet
	26-April-2010** Team 1	1843	8	5	0	0	1 frog every 142 feet
	Totals*	7990	49	5	22	0	1 frog every 166 feet
Summer	20-Jul-2010	1658	13	0	0	0	1 frog every 127 feet
	21-Jul-2010	2671	25	5	0	yes	1 frog every 89 feet
	22-Jul-2010	2222	33	17	4	yes	1 frog every 44 feet
	Totals	6551	71	22	4	yes	1 frog every 70 feet
<p>*AECOM surveyors repeated a portion of Winter Survey area between the Baron Ranch Bridge and Pool 6 to attempt to detect tagged individuals on March 9, 2010. Repeated survey area is not included in the total numbers above or in the statistical analysis presented. Results of the repeat survey between the Arroyo Quemado Bridge and Pool 6: 20 adults, and 5 metamorphs were observed within 1820 feet surveyed for a density of 1 frog every 91 feet.</p> <p>**USGS Team 2 repeated a portion of the Winter Survey area between Pool 1 and Pool 15 to collect tissue samples on April 26, 2010. Distance surveyed was 3256 feet, 15 adults, 1 metamorph, and no tadpoles were observed. The density of frogs was 1 frog every 217 feet. This information is not included in the total numbers above or the statistical analysis.</p>							

Table 5. California Red-legged Frog Observations in Study Pools for 2010 Winter and Summer Surveys

Pool Number	2010 Winter Survey CRLF Observed				Partial Repeat 2010 Winter Survey Adult & Juvenile Observations		2010 Summer Survey CRLF Observed			
	Adults	Juveniles	Metamorphs	Tadpoles	AECOM	USGS	Adults	Juveniles	Metamorphs	Tadpoles
Baron Pool 1	5	0	0	0	-	-	5	2	1	0
Baron Pool 2	1	2	0	0	-	-	3	1	0	0
Baron Pool 3	3	0	0	0	2	0	1	0	0	0
Baron Pool 4	0	0	0	0	2	0	4	2	0	yes
Baron Pool 4a/4b	3	0	0	0	6	0	7	4	1	0
Baron Pool 5	3	0	0	0	-	-	1	0	0	0
Baron Pool 6	0	0	0	0	1*	0	1	2	0	0
Baron Pool 7	4	0	0	0	1	0	1	0	0	0
Baron Pool 8	1	0	0	0	-	-	0	0	0	0
Baron Pool 9	0	0	0	0	-	-	1	0	0	0
Baron Pool 10	0	0	0	0	-	-	0	0	0	0
Baron Pool 11	3	0	0	0	-	-	3	0	0	0
Baron Pool 12	1	0	1	0		-	0	0	0	0
Baron Pool 13	3	0	0	0	-	-	3	0	0	0
Baron Pool 14	0	0	0	0	-	-	0	0	0	0
Baron Pool 15	3	0	0	0	-	-	4	0	0	0
Totals	32	2	1	0	12	0	45	11	2	-

** 1 metamorph observed at Pool 6.

Table 6. California Red-legged Frog Capture Rates

Survey Season	Survey Date	Total Adults Detected	Total Captured	% Captured
Winter	27-Jan-2010	12	5	42%
	28-Jan-2010	10	5	50%
	29-Jan-2010	11	6	55%
	09-Mar-2010	28	18	64%
	26-April-2010	13	10	77%
Summer	20-Jul-2010	13	8	62%
	21-Jul-2010	30	13	43%
	22-Jul-2010	50	27	54%

Incidental wildlife observations are presented in Table 7. Incidental species were recorded at discrete locations during the surveys: barn owl (*Tyto alba*), grey fox (*Urocyon cinereoargenteus*), slender salamander (*Batrachoseps attenuates*), and southwestern pond turtle (*Emys marmorata*). Additionally, pacific treefrogs (*Pseudacris regilla*), raccoon (*Procyon lotor*) tracks, and striped skunk (*Mephitis mephitis*) odor and tracks were all observed in the drainage. Additionally, a dead deer which may have been a mountain lion (*Puma concolor*) cache, was also observed near Pool 14. No bullfrogs (*Lithobates catesbeianus*) were observed during any survey.

Table 7. Incidental Wildlife Observations

Date	Location	Common Name (<i>Genus species</i>)	Special Status
27-Jan-2010	Pool 11	barn owl (<i>Tyto alba</i>)	None
29-Jan-2010	Near Pool 4a/b	grey fox (<i>Urocyon cinereoargenteus</i>)	None
9-Mar-2010	Upstream of Pool 2	slender salamander (<i>Batrachoseps attenuates</i>)	None
9-Mar-2010	Between Pool 4a/b and Pool 7	2 southwestern pond turtles (<i>Emys marmorata</i>)	California species of special concern
22-Jul-2010	Near Pool 7	3 barn owl fledglings	none
All surveys	ubiquitous	Pacific treefrog (<i>Pseudacris regilla</i>)	none
Multiple	multiple	raccoon (<i>Procyon lotor</i>)	none
27-Jan-2010	Pool 14	Mountain lion (sign) (<i>Puma concolor</i>)	none
28-Jan-2010	Between Arroyo Quemado bridge and Pool 7	striped skunk (<i>Mephitis mephitis</i>)	none

4.0 Discussion

No California red-legged frogs that were PIT-tagged and translocated from the Tajiguas Landfill were recaptured during 2010 monitoring surveys in Arroyo Quemado. However, several of the translocated individuals were recaptured at the in-channel sedimentation basin(s). These recaptures occurred periodically until mid-March of 2010 and are summarized in the annual monitoring reports for 2009 and 2010 for the Tajiguas Landfill Reconfiguration and Baron Ranch Restoration Project. Three of the marked individuals translocated in 2009 were captured at the Landfill on the same nights of the Baron Ranch winter monitoring surveys. The translocated frogs were moving from Arroyo Quemado during the first winter season after translocation as evidenced by their subsequent recaptures at the Landfill. Not all of the marked translocated individuals were redetected at the Landfill. Of the 14 translocated individuals marked, 7 different individuals were redetected at the Landfill (one up to three times) and then translocated again to the designated pools in Arroyo Quemado. It is known that California red-legged frogs use varying habitats throughout the year and may use some areas for foraging and move to others during the breeding season (Fellers and Kleeman 2007). The movements back to the Landfill where deep sedimentation basins were present and suitable for breeding can explain the return movements. These basins have since been removed as a part of the project's construction activities. The remaining 7 translocated individuals that were never recaptured may still be in Arroyo Quemado.

Although no translocated individuals were detected in Arroyo Quemado, a small number of resident Arroyo Quemado individuals were detected following PIT-tagging. Of the 17 resident individuals marked, only three were re-detected (a rate of 17.6%). The overall number of translocated individuals re-detected since translocation is much higher, 50%. These re-detected individuals were found returning to the landfill after translocation.

Although all California red-legged frogs detected during the surveys were recorded, only an average of 58% and 53% of the observed frogs were captured during the winter and summer surveys respectively. Individuals react differently when approached and will evade capture quickly as the headlamp illuminates the area and surveyors approach. This phenomenon was also reported by Fellers and Keeman in their 2007 study where they postulated a high presence of predators created a tendency for frogs to be wary. This may be the case in Arroyo Quemado as predators were recorded during surveys and are likely foraging in the watershed regularly. Regardless of the reason for non-captures, it leaves to question whether uncaptured frogs may have been some of the PIT-tagged individuals. It may therefore be advantageous to conduct additional surveys to recapture and identify the relatively low number of individuals that were marked.

The density of California red-legged frogs (adults and juveniles) observed was higher during the summer survey however, the difference between the summer and winter surveys was not statistically significant. California red-legged frogs move more during the rainy winter months as has been reported previously (Bulger et.al 2003, Fellers and Kleeman 2007). The frogs tend to stay closer to the water sources during the summer months and range further during the breeding season or fall and winter months.

There was not a significant difference in the number of California red-legged frogs observed in the study pools between surveys. However, the study pools give a definitive location to allow repeated surveys to compare over time. Although this study only represents one year of sampling data, the study pools were relatively constant during the first year of study.

A survey of Arroyo Quemado was conducted in February 2008 by the same lead surveyors of this study (ERA 2008). The 2008 survey found 114 frogs over 1.8 miles or 9504 feet for a density of 1 frog every 83 feet. The survey was conducted over the same general area but covered a longer survey extent than this study. The density result of the 2008 estimate is similar to the observed densities of the current study.

5.0 Conclusion

The identified study pools provide a repeatable sampling point to allow collected data to be compared over the duration of the monitoring. Additionally, by comparing the density of individuals observed for each of the survey extents there is also a standardized method of comparison as future surveys collect additional information. This first year of information should be considered a biased baseline year and one additional year of baseline information should be collected. The second year of monitoring should therefore be completed in 2011; a year without any translocation activities. Subsequent years can then draw conclusions based on comparisons. This will allow for a more robust baseline dataset and will also provide a comparison for the 2010 data which followed translocation activities.

Future surveys should also document any changes in the study pools during each survey period. Pools may fluctuate based on the amount of seasonal precipitation, sediment, logs that move through the system, or other obstructions that move and change the depth or size of pools. During this monitoring period the pools were relatively stable and the observed California red-legged frog population within the pools was also stable. Although differences in the number of observed adults and juveniles in each pool were recorded between the winter and summer survey, the difference is not considered statistically significant. Based on this first year of information it appears that Arroyo Quemado is relatively stable and that the population within the pools is also stable.

There is currently not enough information to determine if the restoration activities to date have contributed to an increase in the observed population within Arroyo Quemado (hypothesis number one). The difference in the density of California red-legged frog adults and juveniles, although higher in the summer, was not statistically significant between the seasons. The observed density during the 2008 survey was also similar to the observed density during the 2010 surveys. As the restoration proceeds additional monitoring will be needed to answer hypothesis number 1.

A higher number Juveniles were observed during the summer surveys than the winter surveys. This may be a result of the relocated metamorphs from 2009 maturing to a size where they are detectable. Because this is the first year of conducting this monitoring study there is not enough information to determine if the observed number of juveniles is high or low for this watershed. By comparing the next set of sampling information, a conclusion about whether the number of juveniles observed was significant could answer the question of how the translocation activities influenced the population.

From the survey results in Arroyo Quemado for the 2010 monitoring it is not clear where the translocated individuals from the Tajiguas Landfill may be residing. No translocated individuals were located in Arroyo Quemado during the surveys; although three individuals were translocated on the nights of the surveys and movements continued through Mid-March to the Tajiguas Landfill. It was hypothesized that translocated individuals would be detected during the summer survey. However,

this was not the case. Translocated individuals have eluded further detection and may still be residing in the Arroyo Quemado watershed leaving hypothesis number two in question.

To date, only one PIT-tagged and translocated individual has been found deceased. The disposition of the remaining 13 marked translocated frogs is still unknown. They may still be residing in the Arroyo Quemado drainage and were either not detected during the surveys and/or evaded capture. There is also the possibility that these individuals traveled to the next watershed to the west, Arroyo Hondo, or potentially to the east as these watersheds are within the known distance that California red-legged frogs may travel. Individuals do react to evade predators and have been reported to be quicker to flee in watersheds that have a high number of predators. Having been captured, PIT-tagged, and then relocated may make the marked individuals more likely to evade further capture. However, these individuals may be found in Arroyo Quemado during future surveys.

6.0 References

- Bulger, J.B., N.J. Scott, and R.B. Seymour. 2003. Terrestrial activity and conservation of adult California red-legged frogs (*Rana aurora draytonii*) in coastal forests and grasslands. *Biological Conservation* 110 (2003): 85-95.
- Ecosystems Restoration Associates. 2007. Baron Ranch California Red-legged Frog Habitat Assessment. September. 14 pp + appendices.
- _____. 2008. Baron Ranch: California Red-legged Frog Survey Report and Population Estimate. July 2008.
- _____. 2008. California Red-legged Frog Management Plan for the Tajiguas Landfill Reconfiguration and Baron Ranch Restoration Project, Santa Barbara County. July 2008.
- Fellers, G.M., Kleeman, P.M. 2007. California red-legged frog (*Rana draytonii*) movement and habitat use: implications for conservation. *Journal of Herpetology*, Vo. 41 No. 2, pp. 276-286.
- U.S. Fish and Wildlife Service. 2009. Reinitiated Biological Opinion for the Tajiguas Landfill Reconfiguration Project, Santa Barbara County, (File No. 200801191-JWM)(8-8-09-F-50R). October 9, 2009.
- _____. 2009a. Letter concerning Hazardous Materials and the California Red-legged Frog Tadpole Relocation Plans for the Tajiguas Landfill Reconfiguration Project, Santa Barbara County (8-8-09-F/C). July 9.
- _____. 2009b. Biological and Conference Opinions for the Tajiguas Landfill Reconfiguration and Baron Ranch Restoration Project, Santa Barbara County (File No. 20081191-JWM)(8-8-09F/C-7) June 12.
- U.S. Army Corps of Engineers. 2009. Section 404 Individual Permit, Permit Number SPL-2008-01191-JWM.

Figures



Path: J:\Client\Projects\County of Santa Barbara\60146344-Baron_CRLF_Surveys\Graphics\GIS\figure1.mxd

AECOM
AECOM ENVIRONMENT
 1220 AVENIDA ACASO
 CAMARILLO, CALIFORNIA 93012
 PHONE: 805.388.3775
 FAX: 805.388.3577
 WEB: [HTTP://WWW.AECOM.COM](http://www.aecom.com)

SITE LOCATION MAP		
BARON RANCH CRLF MONITORING COUNTY OF SANTA BARBARA		
DRAWN BY:	DATE:	PROJECT NUMBER:
M. Scop	3/18/2011	60146344

FIGURE NUMBER:
1
SHEET NUMBER:
1 of 1

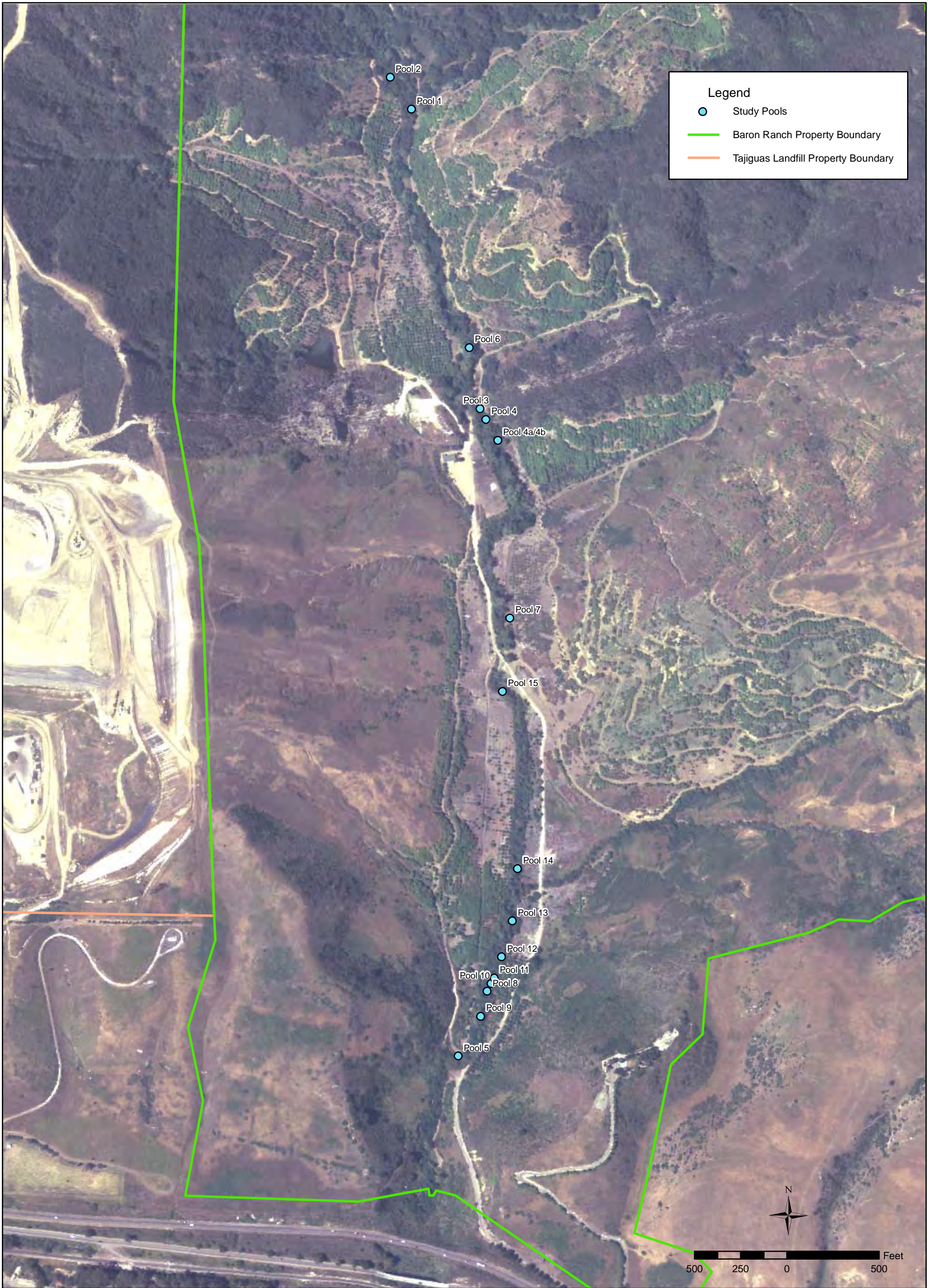

Aerial Photo:
California Spatial Information Library, NAIP, 2005 Santa Barbara County.

SHEET NUMBER:
X

FIGURE NUMBER:
2

ARROYO QUEMADO STUDY POOLS		
BARON RANCH CRLF MONITORING COUNTY OF SANTA BARBARA		
SCALE:	DATE:	PROJECT NUMBER:
AS SHOWN	3/18/2011	60146344

AECOM

AECOM
1220 AVENIDA ACASO
CAMARILLO, CALIFORNIA 93012
PHONE: (805) 388-3775
FAX: (805) 388-3577
WEB: HTTP://WWW.AECOM.COM

DESIGNED BY:	REVISIONS:			
	NO:	DESCRIPTION:	DATE:	BY:
J. Niceswanger				
DRAWN BY:				
M. Scop				
CHECKED BY:				
J. Niceswanger				
APPROVED BY:				
J. Niceswanger				

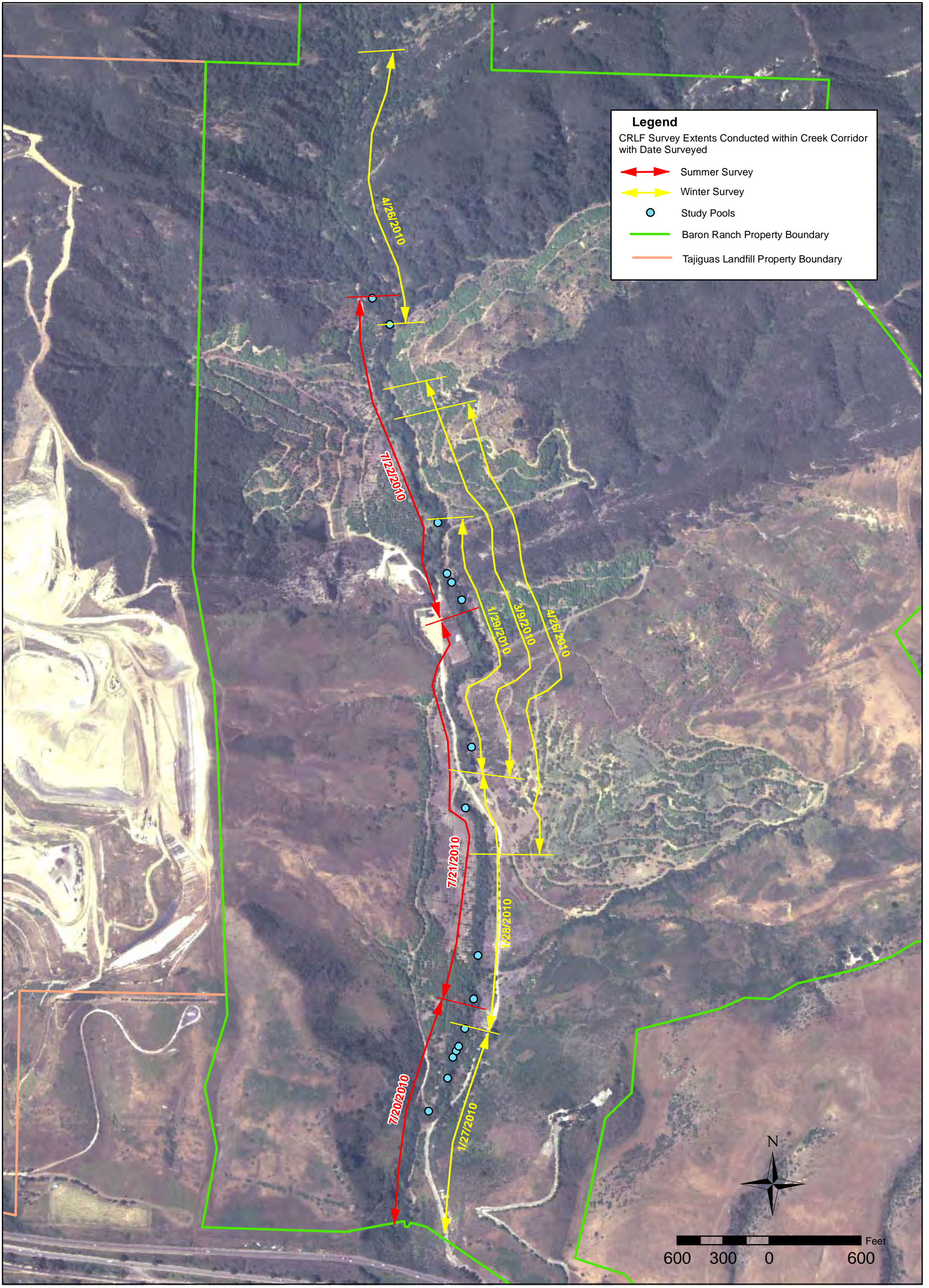

Aerial Photo: California Spatial Information Library, NAIP, 2005 Santa Barbara County.

SHEET NUMBER:	3
FIGURE NUMBER:	X

ARROYO QUEMADO SURVEY EXTENTS		
BARON RANCH CRLF MONITORING COUNTY OF SANTA BARBARA		
SCALE:	DATE:	PROJECT NUMBER:
AS SHOWN	3/18/2011	60146344

AECOM
1220 AVENIDA ACASO
CAMARILLO, CALIFORNIA 93012
PHONE: (805) 388-3775
FAX: (805) 388-3577
WEB: HTTP://WWW.AECOM.COM

DESIGNED BY:	REVISIONS:		
	NO:	DESCRIPTION:	DATE:
J. Niceswanger			
DRAWN BY:			
M. Scop			
CHECKED BY:			
J. Niceswanger			
APPROVED BY:			
J. Niceswanger			

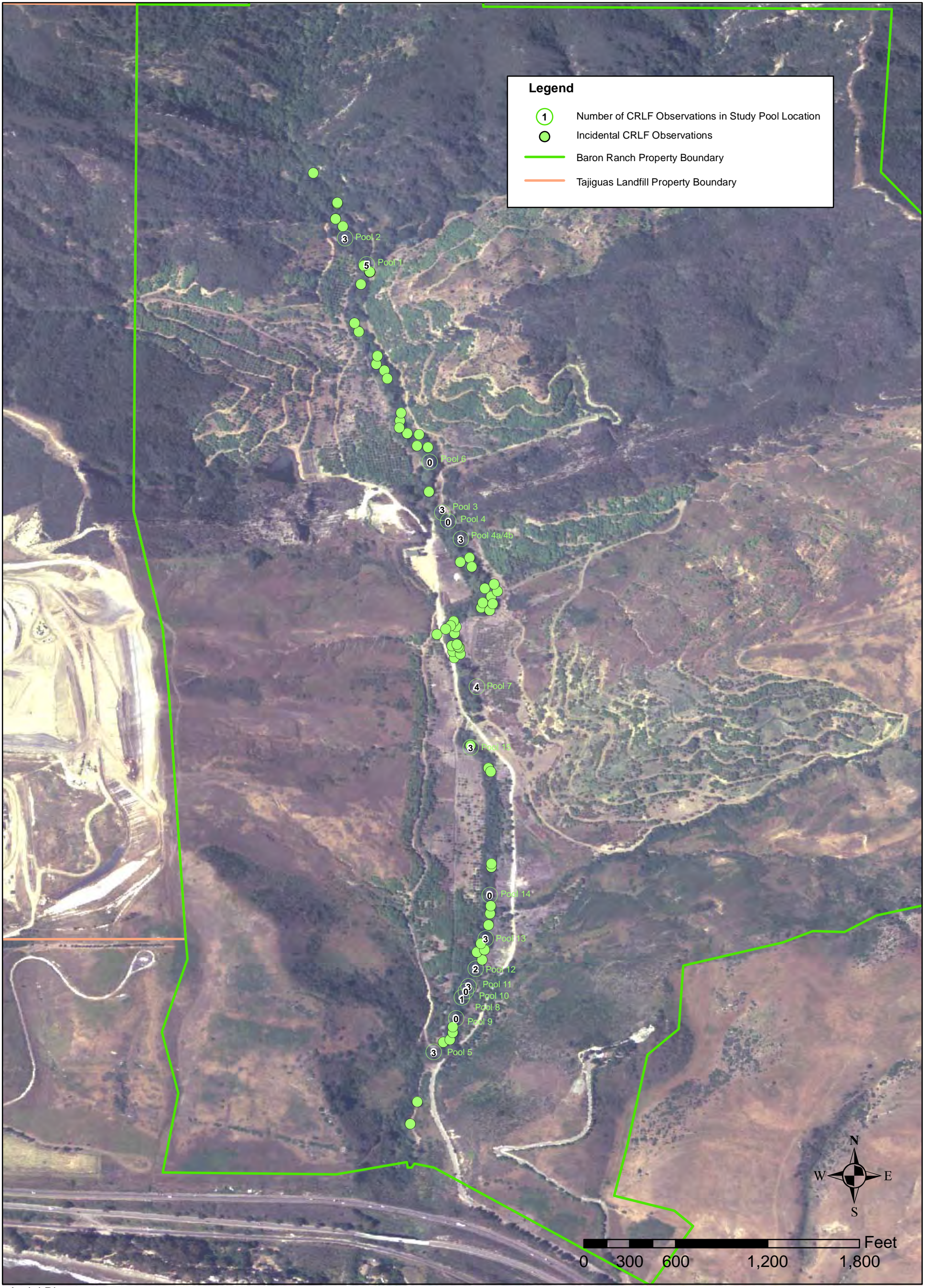

Legend

- ① Number of CRLF Observations in Study Pool Location
- Incidental CRLF Observations
- Baron Ranch Property Boundary
- Tajiguas Landfill Property Boundary

Aerial Photo: California Spatial Information Library, NAIP, 2005 Santa Barbara County.

SHEET NUMBER:
X

FIGURE NUMBER:
4

ARROYO QUEMADO WINTER 2010 SURVEY RESULTS		
BARON RANCH CRLF MONITORING COUNTY OF SANTA BARBARA		
SCALE:	DATE:	PROJECT NUMBER:
AS SHOWN	3/18/2011	60146344

AECOM
 1220 AVENIDA ACASO
 CAMARILLO, CALIFORNIA 93012
 PHONE: (805) 388-3775
 FAX: (805) 388-3577
 WEB: HTTP://WWW.AECOM.COM

DESIGNED BY:	REVISIONS:			
	NO:	DESCRIPTION:	DATE:	BY:
J. Niceswanger				
DRAWN BY:				
M. Scop				
CHECKED BY:				
J. Niceswanger				
APPROVED BY:				
J. Niceswanger				

Path: J:\Client-Projects\County_of_Santa_Barbara\60146344-Baron_CRLF_Surveys\Graphics\GIS\figure4-winter_survey_results.mxd

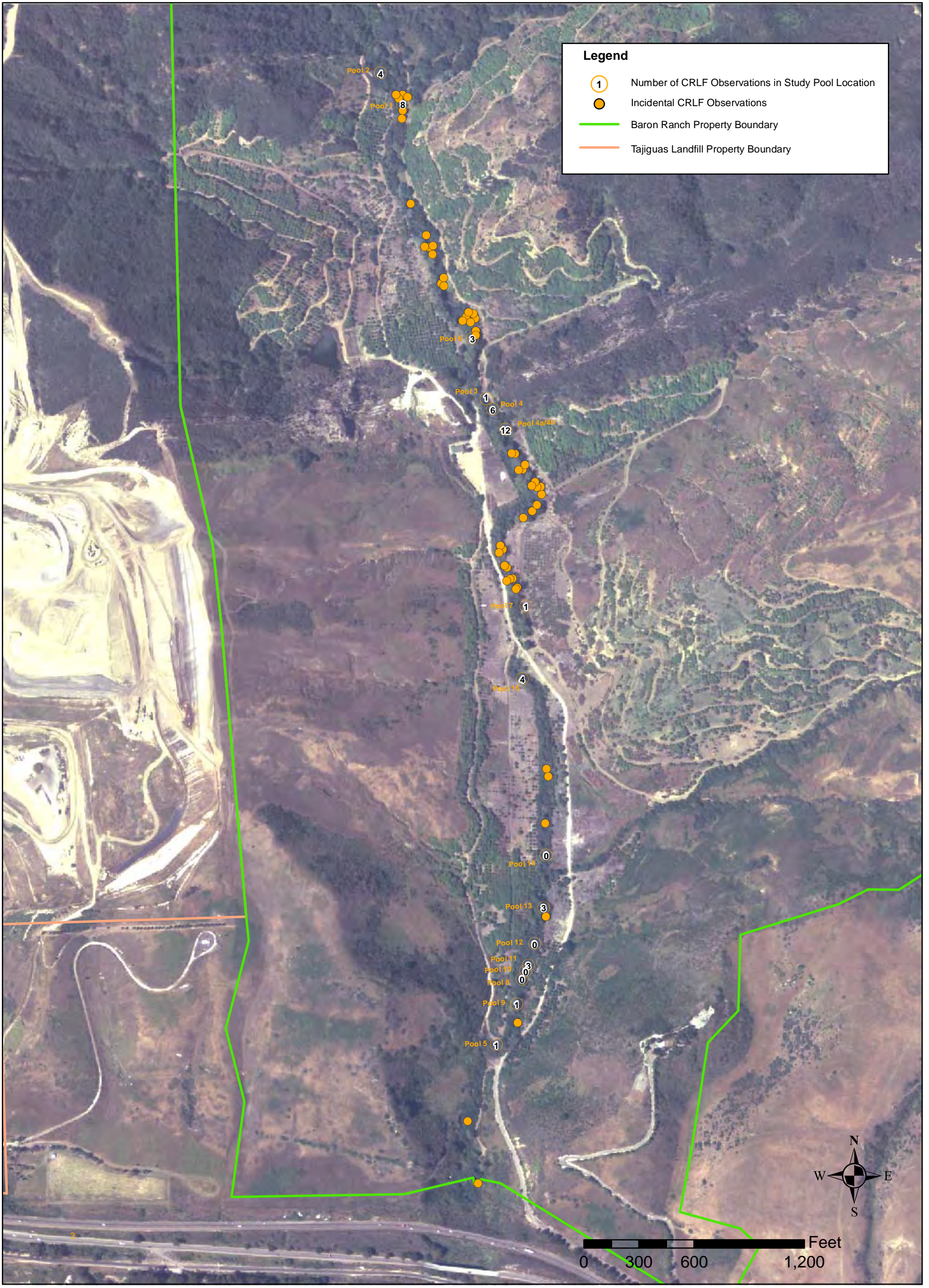

Legend

- ① Number of CRLF Observations in Study Pool Location
- Incidental CRLF Observations
- Baron Ranch Property Boundary
- Tajiguas Landfill Property Boundary

Aerial Photo: California Spatial Information Library, NAIP, 2005 Santa Barbara County.

SHEET NUMBER:
X

FIGURE NUMBER:
5

ARROYO QUEMADO SUMMER 2010 SURVEY RESULTS

BARON RANCH CRLF MONITORING
COUNTY OF SANTA BARBARA

SCALE:	DATE:	PROJECT NUMBER:
AS SHOWN	3/18/2011	60146344

AECOM

AECOM
1220 AVENIDA ACASO
CAMARILLO, CALIFORNIA 93012
PHONE: (805) 388-3775
FAX: (805) 388-3577
WEB: HTTP://WWW.AECOM.COM

DESIGNED BY:	REVISIONS:			
J. Niceswanger	NO:	DESCRIPTION:	DATE:	BY:
DRAWN BY:				
M. Scop				
CHECKED BY:				
J. Niceswanger				
APPROVED BY:				
J. Niceswanger				

From: [Leipner, Joddi](#)
To: ["Chris_Dellith@fws.gov"](mailto:Chris_Dellith@fws.gov)
Cc: [Ken Gilliland \(kgilliland@PADREINC.com\)](mailto:Ken_Gilliland@PADREINC.com); [Schleich, Mark](#)
Bcc: [Leipner, Joddi](#); [Gonzales-Knight, Jeanette](#)
Subject: Tajiguas Landfill CRLF Observations
Date: Tuesday, February 14, 2017 9:23:03 AM
Importance: High

Hi Chris,

David Simmons was our primary contact regarding California red-legged frog issues at the Tajiguas Landfill but I know he is now working back east. We had also been in touch with you in the past about CRLF at the landfill and Baron Ranch. I wanted to reach out to you because during a survey last night by our USFWS approved biologist (Ken Gilliland), 2 adults and 1 juvenile was observed at the landfill. We have a biological opinion for the landfill reconfiguration project that allows us to translocate the individuals to pools on Baron Ranch. The juvenile was captured in the reconfiguration area and translocated to Baron however, the two adults were not within the reconfiguration project area, but were observed in another sedimentation basin in the southern area of the landfill. We had never observed CRLF in this area before. We would like to discuss options with you regarding the two individuals. Are you available for a conference call today with Ken and me?

Thank you,

Joddi

Joddi Leipner
Senior Engineering Environmental Planner
Resource Recovery and Waste Management
130 E. Victoria Street, Suite 100
Santa Barbara, CA 93101
(805) 882-3614

EXHIBIT 2

From: [Leipner, Joddi](#)
To: [Spier, Travis](#); [Curtis, Todd](#); [Dimock, Ed](#); [Gonzales-Knight, Jeanette](#); [Cragin, Imelda](#); [Hancock, John](#)
Cc: [Schleich, Mark](#)
Subject: FW: Tajiguas landfill (UNCLASSIFIED)
Date: Wednesday, February 15, 2017 4:00:37 PM
Importance: High

FYI, in order to address CRLF issues in the south basin we have had to amend our 404 permit and our BO to include the south sedimentation basin as an aquatic feature regulated by the Army Corps of Engineers under our construction permit for the landfill reconfiguration project. As construction activities for the reconfiguration project are planned to possibly be finished this next summer we will in the very near future need to discuss CRLF management issues post construction.

Joddi

Joddi Leipner
Senior Engineering Environmental Planner
Resource Recovery and Waste Management
130 E. Victoria Street, Suite 100
Santa Barbara, CA 93101
(805) 882-3614

From: Dellith, Chris [mailto:chris_dellith@fws.gov]
Sent: Wednesday, February 15, 2017 3:14 PM
To: Szijj, Antal J CIV USARMY CESPL (US)
Cc: Schleich, Mark; Leipner, Joddi; Rick Farris; Thogerson, Collette
Subject: Re: Tajiguas landfill (UNCLASSIFIED)

Hi Antal,

With this email, we are amending the biological opinion (8-8-09-F-50R) to incorporate the additional detention basin at the southern region of the Tajiguas landfill into the project description for the facility as a Corps jurisdictional aquatic feature. Including this additional area in the project description and baseline does not go beyond or result in effects not considered in the biological opinion. We understand that all terms and conditions, as well as, minimization measures, including relocating California red-legged frogs out of harm's way, will continue to be implemented. Therefore, the affects analysis in the biological opinion valid and reinitiation of formal consultation is not required at this time. If you have any questions please contact me or Collette Thogerson (copied).

Sincerely,
Chris

On Wed, Feb 15, 2017 at 2:49 PM, Szijj, Antal J CIV USARMY CESPL (US) <Antal.J.Szijj@usace.army.mil> wrote:
CLASSIFICATION: UNCLASSIFIED

Rick/Chris,
Reference is made to your biological opinion (no 8-8-09-F-50R) issued to address adverse effects to California red-legged frog resulting from our issuance of a permit authorizing the discharge fill material into waters of the U.S., in association with the expansion of the Tajiguas Landfill in Santa Barbara County. At the request of Santa Barbara County Resource

Recovery and Waste Management an additional detention basin will be incorporated into the project description for the facility as a jurisdictional aquatic feature. The Corps will likely amend our permit or issue a separate authorization to address future maintenance of this basin.

Recent surveys have indicated CRLF individuals have occupied this basin which may be threatened with heavy runoff in predicted rainfall later this week. The permittee is requesting their biologists be authorized to handle these CRLF and relocate them in the same manner as has been conducted in other areas in association with the expansion project.

The Corps believes the relocation activities in this basin, if included in the BO, would not materially change the conclusions of the BO. All terms and conditions would continue to be implemented in association with our federal action, which is ongoing at this time. I hereby request your concurrence with this determination.

Please call or email me if you have any questions.

Antal

Antal Szijj
Team Lead
Regulatory Division, Ventura Field Office
2151 Alessandro Dr., Suite 110
Ventura, CA 93001
U.S. Army Corps of Engineers, Los Angeles District
antal.j.szijj@usace.army.mil

Office: (805) 585-2147

visit our website at: <http://www.spl.usace.army.mil/Missions/Regulatory.aspx>

Assist us in better serving you!

You are invited to complete our customer survey, located at the following link:

http://corpsmapu.usace.army.mil/cm_apex/f?p=regulatory_survey

Note: If the link is not active, copy and paste it into your internet browser.

-----Original Message-----

From: Leipner, Joddi [mailto:Jleipner@cosbpw.net]

Sent: Wednesday, February 15, 2017 1:46 PM

To: Szijj, Antal J CIV USARMY CESPL (US) <Antal.J.Szijj@usace.army.mil>

Cc: Schleich, Mark <Schleich@cosbpw.net>; Chris_Dellith@fws.gov

Subject: [EXTERNAL] RE: Emailing - Pages from Final SEIR vol 1.pdf (UNCLASSIFIED)

Importance: High

Hi Antal,

Per our discussion, please see attached. We are requesting that our south sedimentation basin be covered as waters of the US and within the project covered by ACOE Permit # SPL-2008-

01191-JWM and USFWS BO # (File No. 200801191-JWM)(8-8-09-F-50R). As per my call with Chris Dellith of the USFWS, they will need an email from ACOE that states that you do not feel that the effects of adding the new area goes beyond the effect analyzed in the BO and that all terms, conditions and measures will continue to be implemented and that you request they amend the BO to include the new area. Please include me and the following individuals in the cc on the email to Chris.

chris_dellith@fws.gov
collette_thogerson@fws.gov
Rick_Farris@r1.fws.gov
Schleich@cosbpw.net

Thank you for all your help and please call me if you need anything further.

Joddi

Joddi Leipner
Senior Engineering Environmental Planner
Resource Recovery and Waste Management
130 E. Victoria Street, Suite 100
Santa Barbara, CA 93101
(805) 882-3614

-----Original Message-----

From: Szijj, Antal J CIV USARMY CESPL (US) [mailto:Antal.J.Szijj@usace.army.mil]
Sent: Wednesday, February 15, 2017 12:32 PM
To: Leipner, Joddi
Subject: RE: Emailing - Pages from Final SEIR vol 1.pdf (UNCLASSIFIED)

CLASSIFICATION: UNCLASSIFIED

Hi Jodi,

We can include this area in our scope. It would help if you could fill out the attached form as much as possible which is basically you as the applicant/permittee stipulating that the site in question (the basin) is water of the U.S.

Antal

Antal Szijj
Team Lead
Regulatory Division, Ventura Field Office
2151 Alessandro Dr., Suite 110
Ventura, CA 93001
U.S. Army Corps of Engineers, Los Angeles District antal.j.szijj@usace.army.mil

Office: (805) 585-2147

visit our website at: Blocked<http://www.spl.usace.army.mil/Missions/Regulatory.aspx>

Assist us in better serving you!

You are invited to complete our customer survey, located at the following link:
Blockedhttp://corpsmapu.usace.army.mil/cm_apex/f?p=regulatory_survey

Note: If the link is not active, copy and paste it into your internet browser.

-----Original Message-----

From: Leipner, Joddi [mailto:Jleipner@cosbpw.net]

Sent: Wednesday, February 15, 2017 12:08 PM

To: Szijj, Antal J CIV USARMY CESPL (US) <Antal.J.Szijj@usace.army.mil>

Subject: [EXTERNAL] Emailing - Pages from Final SEIR vol 1.pdf

Importance: High

Hi Antal,

Here is the aerial from the EIR. The red outlined area is the general area of the reconfiguration project work. The yellow circle is the area of the south sedimentation basin. Both basins discharge into Pila Creek.

Joddi

Joddi Leipner

Senior Engineering Environmental Planner

Resource Recovery and Waste Management

130 E. Victoria Street, Suite 100

Santa Barbara, CA 93101

(805) 882-3614

CLASSIFICATION: UNCLASSIFIED

CLASSIFICATION: UNCLASSIFIED

--

=====
=====

Chris Dellith, Senior Fish & Wildlife Biologist
U.S. Fish & Wildlife Service
Ventura Field Office
2493 Portola Road, Suite B
Ventura CA. 93003
(805) 644-1766, Ext. 227
chris_dellith@fws.gov



Visit us on the web: <http://ventura.fws.gov>
"Like" us on [Facebook!](#)

From: [Leipner, Joddi](#)
To: "[Dellith, Chris](#)"; "[Szijj, Antal J CIV USARMY CESPL \(US\)](#)"
Cc: [Schleich, Mark](#); "[Rick Farris](#)"; "[Thogerson, Collette](#)"; "[Ken Gilliland \(kgilliland@PADREINC.com\)](#)"
Bcc: [Leipner, Joddi](#)
Subject: RE: Tajiguas landfill (UNCLASSIFIED)
Date: Tuesday, February 21, 2017 9:10:12 AM

Hi Chris,

Ken complete a survey last night (2/20/17) and one adult female CRLF with a total length of 10cm was captured in the southern basin and translocated to pool 9 at Baron Ranch. No other CRLF or egg masses were observed.

Joddi

Joddi Leipner
Senior Engineering Environmental Planner
Resource Recovery and Waste Management
130 E. Victoria Street, Suite 100
Santa Barbara, CA 93101
(805) 882-3614

From: Leipner, Joddi
Sent: Friday, February 17, 2017 2:08 PM
To: 'Dellith, Chris'; 'Szijj, Antal J CIV USARMY CESPL (US)'
Cc: Schleich, Mark; 'Rick Farris'; 'Thogerson, Collette'; 'Ken Gilliland (kgilliland@PADREINC.com)'
Subject: RE: Tajiguas landfill (UNCLASSIFIED)
Importance: High

Hi Chris,

We would like to add the following biologist, Zackary Abbey, from Padre Associates to our list of approved biologists to independently survey, capture, and translocate CRLF under our Biological Opinion for the Tajiguas Landfill (8-8-09-F-50R). His qualifications are attached. Also I was advised by our biologist, Ken Gilliland, that he is going to survey and attempt to translocate the two frogs observed at the landfill sedimentation basin on Monday night.

Joddi

Joddi Leipner
Senior Engineering Environmental Planner
Resource Recovery and Waste Management
130 E. Victoria Street, Suite 100
Santa Barbara, CA 93101
(805) 882-3614

From: Leipner, Joddi
Sent: Thursday, February 16, 2017 11:29 AM

To: 'Dellith, Chris'; Szijj, Antal J CIV USARMY CESPL (US)
Cc: Schleich, Mark; Rick Farris; Thogerson, Collette; Ken Gilliland (kgilliland@PADREINC.com)
Subject: RE: Tajiguas landfill (UNCLASSIFIED)
Importance: High

Hi All,

Just to keep you informed, I am passing along info I received from our biologist (Ken Gilliland) this morning. Ken and another Padre biologist attempted to capture the two frogs observed in the basin last night (2/15/17), but due to safety concerns they were unsuccessful. According to Ken, there is between a 3.5 to 4-foot deep accumulation of sticky and soupy mud in the basin that prevented accessing areas of the basin where the CRLF were observed. Walking within the basin was incredibly difficult and there was a high risk of losing footing and becoming stuck or submerged in the mud. Additionally, the CRLF were very weary of his approach and quickly swam away. The CRLF were observed along the edge of a 6 to 8-inch deep lens of surface water that has accumulated in the center of the basin above the mud. The lens of surface water was a minimum of 4-feet laterally from the sloped sides of the basin. Ken believes that the safest and most effective path forward is to allow the storms forecasted over the next few days to pass and attempt to capture the CRLF on Sunday night (2/19/17). He is planning on using a boat to safely access all areas of the basin while water is in the basin.

Joddi

Joddi Leipner
Senior Engineering Environmental Planner
Resource Recovery and Waste Management
130 E. Victoria Street, Suite 100
Santa Barbara, CA 93101
(805) 882-3614

From: Dellith, Chris [mailto:chris_dellith@fws.gov]
Sent: Wednesday, February 15, 2017 3:14 PM
To: Szijj, Antal J CIV USARMY CESPL (US)
Cc: Schleich, Mark; Leipner, Joddi; Rick Farris; Thogerson, Collette
Subject: Re: Tajiguas landfill (UNCLASSIFIED)

Hi Antal,

With this email, we are amending the biological opinion (8-8-09-F-50R) to incorporate the additional detention basin at the southern region of the Tajiguas landfill into the project description for the facility as a Corps jurisdictional aquatic feature. Including this additional area in the project description and baseline does not go beyond or result in effects not considered in the biological opinion. We understand that all terms and conditions, as well as, minimization measures, including relocating California red-legged frogs out of harm's way, will continue to be implemented. Therefore, the affects analysis in the biological opinion valid and reinitiation of formal consultation is not required at this time. If you have any questions please contact me or Collette Thogerson (copied).

Sincerely,
Chris

On Wed, Feb 15, 2017 at 2:49 PM, Szijj, Antal J CIV USARMY CESPL (US)
<Antal.J.Szijj@usace.army.mil> wrote:
CLASSIFICATION: UNCLASSIFIED

Rick/Chris,

Reference is made to your biological opinion (no 8-8-09-F-50R) issued to address adverse effects to California red-legged frog resulting from our issuance of a permit authorizing the discharge fill material into waters of the U.S., in association with the expansion of the Tajiguas Landfill in Santa Barbara County. At the request of Santa Barbara County Resource Recovery and Waste Management an additional detention basin will be incorporated into the project description for the facility as a jurisdictional aquatic feature. The Corps will likely amend our permit or issue a separate authorization to address future maintenance of this basin.

Recent surveys have indicated CRLF individuals have occupied this basin which may be threatened with heavy runoff in predicted rainfall later this week. The permittee is requesting their biologists be authorized to handle these CRLF and relocate them in the same manner as has been conducted in other areas in association with the expansion project.

The Corps believes the relocation activities in this basin, if included in the BO, would not materially change the conclusions of the BO. All terms and conditions would continue to be implemented in association with our federal action, which is ongoing at this time. I hereby request your concurrence with this determination.

Please call or email me if you have any questions.

Antal

Antal Szijj
Team Lead
Regulatory Division, Ventura Field Office
2151 Alessandro Dr., Suite 110
Ventura, CA 93001
U.S. Army Corps of Engineers, Los Angeles District
antal.j.szijj@usace.army.mil

Office: (805) 585-2147

visit our website at: <http://www.spl.usace.army.mil/Missions/Regulatory.aspx>

Assist us in better serving you!

You are invited to complete our customer survey, located at the following link:

http://corpsmapu.usace.army.mil/cm_apex/f?p=regulatory_survey

Note: If the link is not active, copy and paste it into your internet browser.

-----Original Message-----

From: Leipner, Joddi [mailto:Jleipner@cosbpw.net]

Sent: Wednesday, February 15, 2017 1:46 PM
To: Szijj, Antal J CIV USARMY CESPL (US) <Antal.J.Szijj@usace.army.mil>
Cc: Schleich, Mark <Schleich@cosbpw.net>; Chris_Dellith@fws.gov
Subject: [EXTERNAL] RE: Emailing - Pages from Final SEIR vol 1.pdf (UNCLASSIFIED)
Importance: High

Hi Antal,

Per our discussion, please see attached. We are requesting that our south sedimentation basin be covered as waters of the US and within the project covered by ACOE Permit # SPL-2008-01191-JWM and USFWS BO # (File No. 200801191-JWM)(8-8-09-F-50R). As per my call with Chris Dellith of the USFWS, they will need an email from ACOE that states that you do not feel that the effects of adding the new area goes beyond the effect analyzed in the BO and that all terms, conditions and measures will continue to be implemented and that you request they amend the BO to include the new area. Please include me and the following individuals in the cc on the email to Chris.

chris_dellith@fws.gov
collette_thogerson@fws.gov
Rick_Farris@r1.fws.gov
Schleich@cosbpw.net

Thank you for all your help and please call me if you need anything further.

Joddi

Joddi Leipner
Senior Engineering Environmental Planner
Resource Recovery and Waste Management
130 E. Victoria Street, Suite 100
Santa Barbara, CA 93101
(805) 882-3614

-----Original Message-----

From: Szijj, Antal J CIV USARMY CESPL (US) [mailto:Antal.J.Szijj@usace.army.mil]
Sent: Wednesday, February 15, 2017 12:32 PM
To: Leipner, Joddi
Subject: RE: Emailing - Pages from Final SEIR vol 1.pdf (UNCLASSIFIED)

CLASSIFICATION: UNCLASSIFIED

Hi Jodi,

We can include this area in our scope. It would help if you could fill out the attached form as much as possible which is basically you as the applicant/permittee stipulating that the site in question (the basin) is water of the U.S.

Antal

Antal Szijj
Team Lead

Regulatory Division, Ventura Field Office
2151 Alessandro Dr., Suite 110
Ventura, CA 93001
U.S. Army Corps of Engineers, Los Angeles District antal.j.szijj@usace.army.mil

Office: (805) 585-2147

visit our website at: Blocked<http://www.spl.usace.army.mil/Missions/Regulatory.aspx>

Assist us in better serving you!

You are invited to complete our customer survey, located at the following link:

Blockedhttp://corpsmapu.usace.army.mil/cm_apex/f?p=regulatory_survey

Note: If the link is not active, copy and paste it into your internet browser.

-----Original Message-----

From: Leipner, Joddi [mailto:Jleipner@cosbpw.net]

Sent: Wednesday, February 15, 2017 12:08 PM

To: Szijj, Antal J CIV USARMY CESPL (US) <Antal.J.Szijj@usace.army.mil>

Subject: [EXTERNAL] Emailing - Pages from Final SEIR vol 1.pdf

Importance: High

Hi Antal,

Here is the aerial from the EIR. The red outlined area is the general area of the reconfiguration project work. The yellow circle is the area of the south sedimentation basin. Both basins discharge into Pila Creek.

Joddi

Joddi Leipner

Senior Engineering Environmental Planner

Resource Recovery and Waste Management

130 E. Victoria Street, Suite 100

Santa Barbara, CA 93101

(805) 882-3614

CLASSIFICATION: UNCLASSIFIED
CLASSIFICATION: UNCLASSIFIED

--

=====

Chris Dellith, Senior Fish & Wildlife Biologist
U.S. Fish & Wildlife Service
Ventura Field Office
2493 Portola Road, Suite B
Ventura CA. 93003
(805) 644-1766, Ext. 227
chris_dellith@fws.gov



Visit us on the web: <http://ventura.fws.gov>
"Like" us on [Facebook!](#)

From: [Leipner, Joddi](#)
To: [Spier, Travis](#); [Curtis, Todd](#); [Dimock, Ed](#); [Hancock, John](#)
Cc: [Gonzales-Knight, Jeanette](#); [Cragin, Imelda](#); [Schleich, Mark](#)
Bcc: [Leipner, Joddi](#)
Subject: RE: TJ Survey 2/22/17
Date: Thursday, February 23, 2017 12:58:12 PM

Hi All,

The depth of water in the basins is correct. Ken and another biologist (for safety) will go out after the next rain event (Monday night) to try and translocate the CRLF observed in the southern basin.

Joddi

Joddi Leipner
Senior Engineering Environmental Planner
Resource Recovery and Waste Management
130 E. Victoria Street, Suite 100
Santa Barbara, CA 93101
(805) 882-3614

-----Original Message-----

From: Leipner, Joddi
Sent: Thursday, February 23, 2017 10:45 AM
To: Spier, Travis; Curtis, Todd; Dimock, Ed; Hancock, John
Cc: Gonzales-Knight, Jeanette; Cragin, Imelda; Schleich, Mark
Subject: TJ Survey 2/22/17

Hi All,

Results from the survey last night. I'm confirming Ken's information regarding the depth of water in the basins. I'm no:

Hi Joddi,

1 adult CRLF observed in Southern Basin. Safety concerns prevented a capture attempt. No CRLF egg masses observed. I will check on Zack's availability and will call tomorrow to discuss capture plan.

Approximately 12' of surface water in northern basin, 8' of surface water in the southern basin, 2" to 8" of surface water in the in-channel area from water flowing out of the northern basin culvert and Pila Creek, 18" of surface water downstream of the spillway, up to 2' of surface water in Pila Creek. 50F with 5-8 mph winds observed during the survey. Skimmers in northern basin are down. Skimmers are up in the Southern basin and there should be enough water to use a boat for the capture attempt.

Thanks,

Ken

Joddi Leipner
Senior Engineering Environmental Planner Resource Recovery and Waste Management
130 E. Victoria Street, Suite 100
Santa Barbara, CA 93101
(805) 882-3614

From: [Leipner, Joddi](#)
To: [Curtis, Todd](#); [Dimock, Ed](#); [Hancock, John](#); [Schleich, Mark](#)
Cc: [Cragin, Imelda](#); [Gonzales-Knight, Jeanette](#); "[Ken Gilliland \(kgilliland@PADREINC.com\)](#)"
Bcc: [Leipner, Joddi](#)
Subject: RE: Bio Survey 2/27/17
Date: Tuesday, February 28, 2017 12:17:37 PM

Hi All,

In searching for the additional adult frog (male) observed in the southern basin last week, Padre observed 10 additional frogs (5 males, 4 females, and 1 juvenile) in the concrete culvert/channel the basin discharges into. The 11 frogs were safely translocated to Baron. As always, as per the training you have received, if you observe any frogs please stop work and contact Padre or me.

Joddi

Joddi Leipner
Senior Engineering Environmental Planner
Resource Recovery and Waste Management
130 E. Victoria Street, Suite 100
Santa Barbara, CA 93101
(805) 882-3614

From: Leipner, Joddi
Sent: Tuesday, February 28, 2017 8:22 AM
To: Curtis, Todd; Dimock, Ed; Hancock, John; Schleich, Mark
Cc: Cragin, Imelda; Gonzales-Knight, Jeanette; Ken Gilliland (kgilliland@PADREINC.com)
Subject: Bio Survey 2/27/17

Hi All,

Additional CRLF we observed by Padre in the area near the south sedimentation basin. I will follow with more info after I speak with him this morning.

Joddi

Joddi Leipner
Senior Engineering Environmental Planner
Resource Recovery and Waste Management
130 E. Victoria Street, Suite 100
Santa Barbara, CA 93101
(805) 882-3614

From: [Leipner, Joddi](#)
To: [Spier, Travis](#); [Curtis, Todd](#); [Dimock, Ed](#); [Cragin, Imelda](#); [Hancock, John](#)
Cc: [Gonzales-Knight, Jeanette](#); [Schleich, Mark](#)
Subject: FW: CRLF Frequent Flyer #2
Date: Friday, April 14, 2017 2:20:11 PM

Hi All,

Ken completed his survey of the landfill last night and no frogs were observed in the back canyon area, however a single adult male (another frequent flier) was observed in the vicinity of the south sedimentation basin and was translocated to Baron.

Joddi

Joddi Leipner
Senior Engineering Environmental Planner
Resource Recovery and Waste Management
130 E. Victoria Street, Suite 100
Santa Barbara, CA 93101
(805) 882-3614 (Work)
(805) 364-1056 (Mobile)

From: Ken Gilliland [mailto:kgilliland@PADREINC.com]
Sent: Friday, April 14, 2017 1:03 PM
To: Leipner, Joddi
Cc: Zachary Abbey
Subject: CRLF Frequent Flyer #2

Hi Joddi,

The adult male CRLF captured last night (4/13/17), was originally captured in the same culvert on 2/27/17. This individual had a total length of 8.5cm. Please see the attached photos, I included photos of the back (dorsal) pattern as the photos of the legs from 2/27/17 is a bit fuzzy. Photos 0825 and 0828 are from 2/27/17, and photos 1989 and 1990 are from 4/13/17.

Thanks,

Ken

Kenneth L. Gilliland
Biologist/Project Manager

Padre Associates, Inc.
1861 Knoll Drive
Ventura, Ca. 93003
Phone: (805) 644-2220 ext. 32
Cell: (805) 290-0541



County of Santa Barbara Planning and Development

John Patton, Director

January 23, 2001

Imelda Cragin
Solid Waste and Utilities Division
Public Works Department
123 East Anapamu Street
Santa Barbara CA 93101

Re: **Tajiguas Landfill Office Trailer relocation and Sediment Control Structure:
Exemption from permit requirements.**

Dear Ms. Cragin:

Our department has reviewed the December 26, 2000 Public Works Department memorandum (attached) regarding the proposed relocation of office trailers and the installation of a sediment control structure (i.e. a sedimentation basin) at the southern end of the existing Tajiguas Landfill. According to the 12-26-00 memorandum, the sediment control facilities are proposed in response to a mandate of the Regional Water Quality Control Board.

The Tajiguas Landfill began operating before 1970, prior to the permit requirements of the California Coastal Act and the environmental review requirements of the California Environmental Quality Act (CEQA). Thus, the landfill constitutes an existing historic public works facility. Ongoing routine landfill activities that occur within the original boundary of the landfill (i.e. on the landfill parcel; APN 081-150-019) and are located below the 1978 Solid Waste Facilities Permit elevation limit of 400 feet MSL are considered part of the ongoing operation of the historic landfill. Implementation of erosion and sedimentation control measures is a routine landfill activity that has occurred in various forms over the decades of landfill operation. Jute matting, soil cement, hydro-seeding, sedimentation basins, and other measures have been utilized at the site to control erosion and sedimentation. The proposed sedimentation basin and associated facilities are considered a part of these ongoing and routine landfill operations. Thus, the proposed installation of a new sedimentation basin does not require a Coastal Development Permit and is not a project under CEQA.

The relocation of temporary trailers to another location at the landfill (in this case, a location outside the Coastal Zone), is also considered part of routine landfill operations and not subject to any permit requirement. The re-location site is identified in the attached 12-26-00 memorandum.

I hope this adequately addresses your questions regarding the permit requirements for the proposed activities at the Tajiguas Landfill.

Sincerely,



Jackie Campbell
Supervising Planner

Attachment: 12-26-00 memorandum to B. Baca from I. Cragin..

Cc: Brian R. Baca, P&D
Chris Wilson, SWUD

G:\...\pub_proj\pw\TJ.sed.basin.doc

**COUNTY OF SANTA BARBARA
PUBLIC WORKS DEPARTMENT**

123 East Anapamu Street
Santa Barbara, California 93101
805\568-3000 FAX 805\568-3019



PHILLIP M. DEMERY
Director

December 26, 2000

Project No. 129902

Planning and Development
123 East Anapamu Street
Santa Barbara, CA 93101

Attn: Brian Baca

Re: Tajiguas Landfill Office Trailers Relocation and Sediment Control Structure

Dear Brian,

The Solid Waste and Utilities Division (SWUD) is proposing to develop a sediment control structure (Structure) at the Tajiguas Landfill. SWUD is under orders from and has been working with the California Regional Water Quality Control Board (RWQCB) to identify workable solutions to control and manage sediment from the landfill.

The Tajiguas Landfill office trailers will be removed from the existing maintenance shop area and relocated to another location within the permitted operating area of the landfill, outside the coastal zone.

The proposed Structure will be located southwest of the Tajiguas Landfill waste prism, adjacent to the existing maintenance shop (see Attachment A, Sheet #1). The proposed location is within the permitted operating area of the landfill, south of the landfill waste prism where there is sufficient flat area to accommodate the Structure.

The purpose of the proposed Structure is to capture sediment with an estimated particle size of 0.43 mm or larger (e.g., coarse sediment particles that would not pass through a #200 mesh sieve) from areas of the landfill where surface water runoff drains to the south.

The contributory watershed area that the proposed Structure will serve totals 75 acres of the Landfill waste prism. This area is divided into two main watersheds: Area A and Area B (see Attachment A, Sheet #2). Contributory Area A is approximately 28 acres. The estimated storm water runoff generated by a 100-year frequency storm for this area is 45.0 cubic feet per second. Contributory Area B is approximately 47 acres. The estimated storm water runoff generated by a 100-year frequency storm for Area B is 70.0 cubic feet per second. Stormwater runoff from both areas will be directed into two main storm drainpipes, which will convey the water to the proposed Structure. The sediment storage capacity for the Structure is estimated to be 860 cubic feet.

The proposed Structure has additional essential design elements. In order to promote drying of the sediment collected in the Structure, a six-inch drainpipe is proposed to drain any standing water above the estimated maximum sediment level in the Structure. The design also includes a secondary overflow as a backup outlet for water moving through the Structure, in the event that flooding or stoppage of water flow in the outlet pipe should occur. All storm drainpipes, inlets, outlets, the weir and the spillway will be sized for a 100-year storm frequency. The Structure will be monitored and cleaned as needed.

The detailed project description, supporting technical documentation and conceptual design of the proposed Structure are presented as Attachment A. Developing the sediment basin would be considered

AA/EEO Employer

Page 2

December 26, 2000

an on-going operation and maintenance activity to control chronic sediment coming from the landfill slopes and may be considered a continuation of Best Management Practices involving sediment control activities under the landfill permit. The Structure would also be part of landfill closure activities, is grandfathered in prior to the Coastal Act, and pre-dates requirements for County Permits. Please review the above information and provide SWUD with a letter concurring that no permit is required.

The SWUD appreciates your time and assistance in determining County permitting required for this activity. It would be greatly appreciated if you would provide the SWUD with your determination by January 11, 2000. If you have questions or require further information, please contact Kathy Kefauver at extension 3614.

Sincerely,

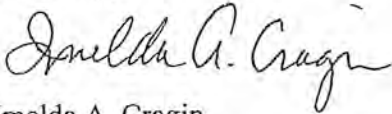

Imelda A. Cragin
Permitting and Engineering Manager

- C: Mark Schleich – Public Works Department
- Mark Tautrim – Public Works Department
- John Haines – Public Works Department
- Walid Farruk – Public Works Department
- Kathy Kefauver – Public Works Department
- Jackie Campbell – Planning and Development

ATTACHMENT A

COUNTY OF SANTA BARBARA TAJIGUAS LANDFILL PROPOSED SEDIMENT CONTROL STRUCTURE PROJECT DESCRIPTION, SUPPORTING TECHNICAL DOCUMENTATION AND CONCEPTUAL DESIGN

The proposed Tajiguas Landfill (Landfill) Sediment Control Structure (Structure) will be located southwest of the Landfill waste prism, adjacent to the existing maintenance shop (see Sheet #1). The proposed location is within the permitted operating area of the Landfill, south of the Landfill where there is sufficient flat area to accommodate the Structure. Before the Structure construction commences, the Landfill administrative offices will be relocated to another area that is still to be determined.

Purpose

The purpose of the Structure is to capture sediment with an estimated particle size of 0.43 mm or larger (e.g., coarse sediment particles that would not pass through a #200 mesh sieve) from areas of the Landfill where surface water runoff drains to the south.

Hydrology Analysis

The contributory watershed area that the proposed Structure will serve totals 75 acres of the Landfill waste prism. This area is divided into two main watersheds: Area A and Area B (see Sheet #2, "Sediment Control Structure Contributory Areas"). Stormwater runoff from both areas will be directed into two main storm drainpipes, which will convey the water to the proposed Structure.

Contributory Area A is approximately 28 acres. The estimated stormwater runoff generated by a 100-year frequency storm for this area is 45.0 cubic feet per second. At present, the stormwater runoff from these 28 acres is collected and routed into two existing storm drainpipes: 1) the 48-inch diameter storm drainpipe that runs along the Landfill access road on the west side of the Landfill, and 2) the 24-inch diameter storm drainpipe located on the first bench behind the maintenance shop (see Sheet #2). Both of these storm drainpipes connect to an existing 64-inch by 40-inch oval corrugated metal pipe (CMP), which connects to the storm drainpipe outlet structure located south of the Landfill administration offices. From here, the stormwater flows into Canada de la Pila Creek (Pila Creek) south of the Landfill.

A new storm drainpipe will be constructed to collect stormwater runoff from Area A as part of the stormwater conveyance system for the proposed Structure. The new storm drainpipe will be located west of the Landfill waste prism and placed along the east side of the Landfill access road (see Sheet #2). It will bring the stormwater runoff from Area A to the proposed Structure. Once this new storm drainpipe is installed, the existing 24-inch and 48-inch drainpipes will no longer be used to route stormwater runoff from the Landfill waste prism.

Contributory Area B is approximately 47 acres. The estimated stormwater runoff generated by a 100-year frequency storm for Area B is 70.0 cubic feet per second. An existing 48-inch diameter storm drainpipe (distinct from the 48-inch drainpipe in Area A) which is located along the southern boundary of the Landfill, currently collects stormwater from the 47 acres of Area B. This pipe conveys stormwater runoff into the storm drainpipe outlet structure currently located south of the Landfill administration offices, where the stormwater is directed into Pila Creek south of the Landfill. The existing storm drainpipe from Area B would be rerouted to connect into the proposed Structure.

Soil Loss Analysis

Using *the Comparative Soil Loss Analysis for Pila Creek Watershed* report prepared by the County of Santa Barbara, Department of Public Works, Solid Waste & Utilities Division, March 31, 2000, the following assumptions are used for the conceptual design of the proposed Structure:

- Potential sediment loading is estimated to be 43 tons per year, based on the Revised Universal Soil Loss Equation (RUSLE), which utilizes an average storm annual precipitation (see Table 1).
- The coarse sediment fraction to be captured by the Structure is estimated to have an average dry soil density of 100 pounds per cubic foot. (see Exhibit A).
- Sediment storage capacity for the Structure is estimated to be 860 cubic feet. (see Exhibit A).

Conceptual Design

The size of the proposed Structure is approximately 100 feet long by 60 feet wide and will be concrete lined. Stormwater collected from Area A will enter from the west side of the Structure, whereas stormwater collected from Area B will enter from the south side of the Structure. Once the water enters

the proposed Structure, the velocity of the water will drop to approximately one foot per second, allowing the coarse sediment to settle. The water will then exit over a weir located along the west side of the Structure. The water will flow to a channel that will convey it to a proposed outlet pipe and be carried to the existing 64-inch by 40-inch diameter oval CMP. From there, the water will be conveyed via the CMP pipe into the storm drainpipe outlet structure, then drain into Pila Creek.

The proposed Structure has additional essential design elements. In order to promote drying of the sediment collected in the Structure, a six-inch drainpipe is proposed to drain any standing water above the Estimated Maximum Sediment Level in the Structure, as shown in the cross-section in lower left-hand corner of Sheet #3, "Sediment Control Structure Conceptual Design." The design also includes a secondary overflow as a backup outlet for water moving through the Structure, in the event that flooding or stoppage of water flow in the outlet pipe should occur. All storm drainpipes, inlets, outlets, the weir and the spillway will be sized for a 100-year storm frequency. The Structure will be monitored and cleaned as needed.

The design of the proposed Structure is conservative because it does not take into consideration two factors regarding the Landfill operations:

1. The *Comparative Soil Loss Analysis for Pila Creek Watershed* report did not take into consideration the further reduction of soil loss from the Pila Creek watershed due to the BMPs for erosion control and sediment management currently implemented at the Landfill site (e.g., straw bales, straw wattles, soil Sement™, rolled erosion control blankets, hydroseeding, temporary water diversion curbs, and sand bags). The implementation of these various BMPs at the Landfill site additionally reduces the amount of soil loss from the Pila Creek Watershed, especially the amount of soil loss from the Landfill waste prism, which contributes stormwater to the proposed Structure.
2. The sediment load received by the Structure will be reduced over time as certain areas of the Landfill undergo phased closure. Once the bench-filling operations at the Landfill are completed, certain areas on the Landfill are anticipated to be closed as part of a phased closure plan for the Landfill. At that time, a portion of the

Landfill would no longer receive waste and an approved final cover system would be installed in that area. This final cover system will also further reduce the amount of soil loss from the contributory areas on the Landfill serviced by the proposed Structure.

Thus, the design of the proposed Structure was based on more conservative assumptions (for the volume of storm-water runoff and soil loss from the areas of Landfill waste prism that drain to the south) than will actually exist during the lifetime of the proposed Structure.

Table 1

SOIL LOSS ESTIMATE SUMMARY AREAS (A) AND (B), TAJIGUAS LANDFILL

ZONES DIRECTLY CONTRIBUTING TO SEDIMENT CONTROL STRUCTURE

ZONE (1)	USDA SOIL CLASS (1)	R (1)	K (1)	LS (1)	C (1)	P (1)	SOIL LOSS RATE (1) [ton / ac-yr]	SEDIMENT YIELD (1) [ton / ac-yr]	AREA SIZE (1) [acres]	POTENTIAL SEDIMENT LOADING (1) [ton / yr]	FINE (2) FRACTION (PASSING #200 SIEVE)	PARTICLE SIZE 0.43 MM OR LARGER	COARSE SEDIMENT LOADING [ton / yr]
Q	AhF2	75	0.28	10.940	0.0012	1.000	0.28	0.28	30	8.40	85%-100%	15%	1.26
R	LcG	75	0.20	0.666	0.0009	1.000	0.01	0.01	13	0.13	25%-40%	75%	0.0975
S	LcG	75	0.20	0.666	0.0009	1.000	0.01	0.01	11	0.11	25%-40%	75%	0.0825
T	AhF2	75	0.28	13.880	0.0783	1.000	23.00	23.00	11	253.00	85%-100%	15%	37.95
U	CdG	75	0.24	10.250	0.0030	1.000	0.55	0.55	10	5.50	35%-65%	65%	3.575
TOTAL													43.0

Notes:

(1) Values from the COMPARATIVE SOIL LOSS ANALYSIS for PILA CREEK WATERSHED prepared by County of Santa Barbara, Department of Public Works, Solid Waste & Utilities Division dated March 31, 2000. Table 1 - Comparative Soil Loss Estimate Summary.

(2) USDA Soil Survey of Santa Barbara County, South Coastal Part, 1981.

EXHIBIT A

TAJIGUAS LANDFILL SEDIMENT CONTROL STRUCTURE

VOLUME CALCULATIONS

Assume Average soil dry density = 100 lbs./cubic feet

Volume = (43 ton x 2000 lbs./ton) / 100 lbs./cubic feet = 860 cubic feet

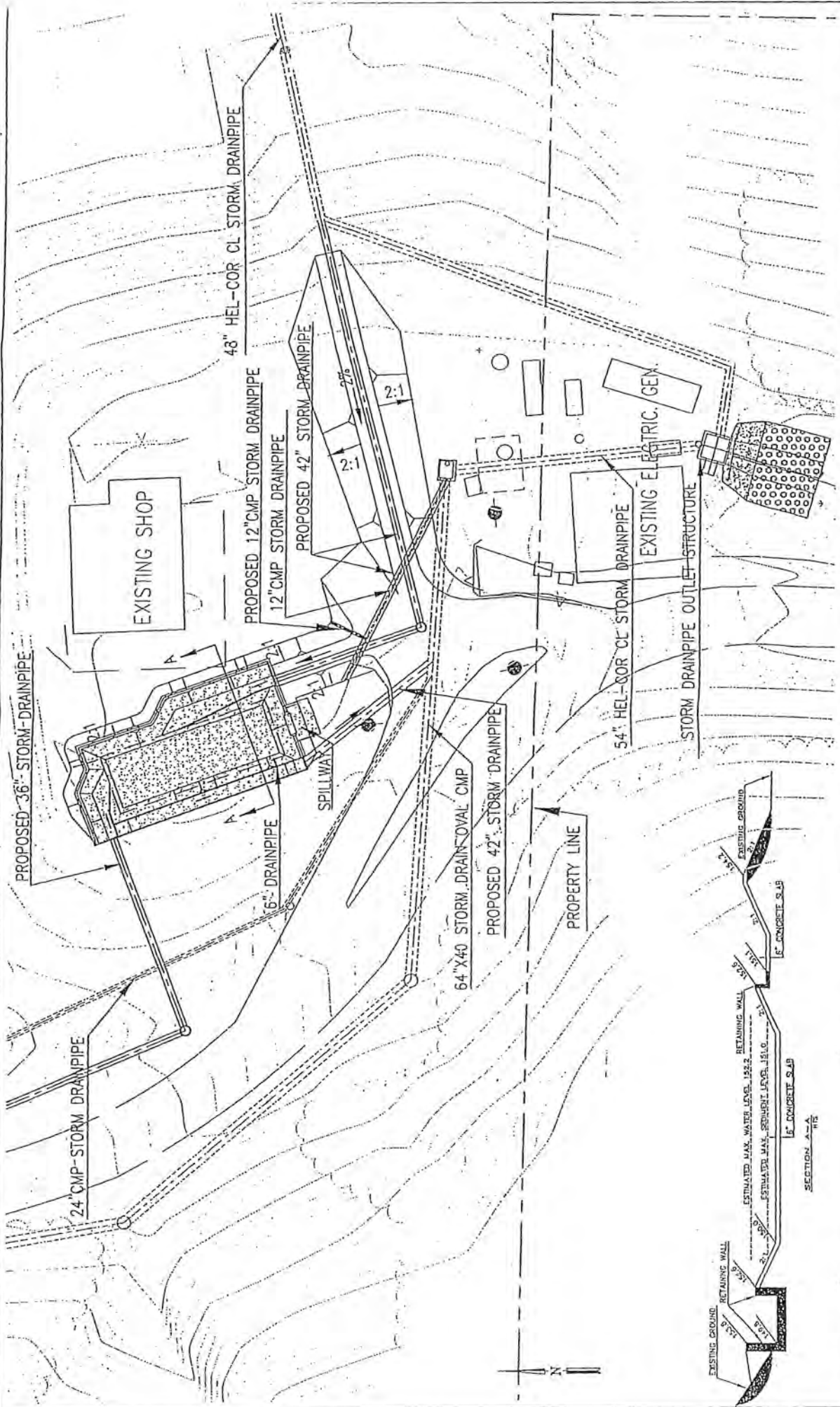

REVISIONS:	DATE:	1:17	PROJECT NUMBER:		DESIGNER:	WALID FARRUKH	CHECKED BY:	WALID FARRUKH	SCALE:	1" = 40'	PROJECT NO.:		TAJIUGAS SANITARY LANDFILL	SHEET 3 OF 3
					CONTRACT NUMBER:								SEDIMENT CONTROL STRUCTURE	
					CONTRACT DATE:								CONCEPTUAL DESIGN	FILE NO.:



AREA A: CONTRIBUTORY AREA TO WEST STORM DRAIN PIPE
 AREA B: CONTRIBUTORY AREA TO SOUTH STORM DRAIN PIPE



1"=240'

REVIEWED BY:
 DESIGNED BY:
 DRAUGHT BY:
 SCALE:
 SHEET 2 of 3

SANTA BARBARA COUNTY
 SOLID WASTE AND UTILITIES DIVISION
 SEDIMENT CONTROL STRUCTURE
 TAJIGUAS SANITARY LANDFILL

REVISIONS	
DATE	DESCRIPTION

CONTRIBUTORY AREAS

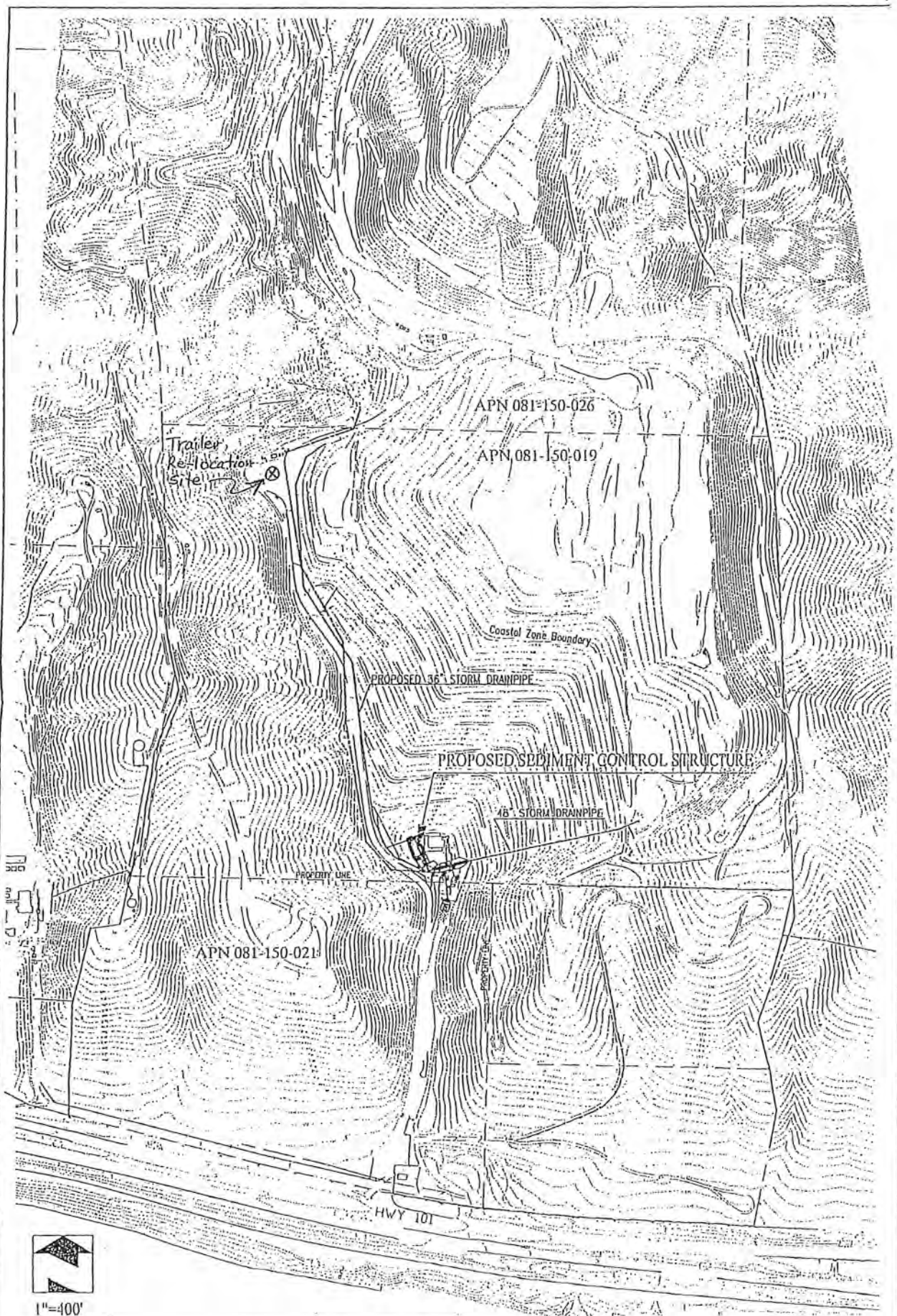

1"=400'

REVIEWED By:
DESIGNED By:
DRAWN By:
SCALE:

SANTA BARBARA COUNTY
 SOLID WASTE AND UTILITIES DIVISION
 SEDIMENT CONTROL STRUCTURE

REVISIONS	
DATE	DESCRIPTION

SITE PLAN

Santa Barbara County
PUBLIC Health
DEPARTMENT



Environmental Health Services

225 Camino del Remedio • Santa Barbara, CA 93110
805/681-4900 • FAX 805/681-4901

Elliot Schulman, MD, MPH *Director/Health Officer*
Anne M. Fearon *Deputy Director*
Suzanne Jacobson, CPA *Chief Financial Officer*
Michele Mielkiewicz, MPH *Deputy Director*
Elizabeth Snyder, MHA *Deputy Director*
Peter Hasler, MD *Medical Director*

2125 S. Centerpointe Pkwy. #333 • Santa Maria, CA 93455-1340
805/346-8460 • FAX 805/346-8485

Rick Merrifield *Director of Environmental Health*

January 12, 2009

Certified Mail

Lillian Conroe
California Integrated Waste Management Board
1001 I Street, MS #15
P.O. Box 4025
Sacramento, CA 95812-4025

026A

Dear Ms. Conroe,

Subject: **Tajiguas Landfill #42-AA-0015 Joint Technical Document (JTD) Amendment**

Environmental Health Services as the Local Enforcement Agency (LEA) received a copy of the subject JTD amendment on December 12, 2008. The amendment was submitted to update the JTD pursuant to the Five-Year Permit Review Report submitted in May 2008. The amendment consists of the following documents:

- Amendments to the Joint Technical Document (JTD), and
- Cover Letter from Santa Barbara County Public Works Department with instructions for insertion.

The changes proposed in the JTD involve updating location information for hazardous waste collection bins, waste tire storage, emergency eyewash/showers and green waste processing areas. Appendix H was also updated to specify the maximum holding time of seven days for green waste.

The LEA has reviewed the JTD amendment and on January 8, 2008 approved it, finding it to meet the requirements of Title 27. The JTD with the subject amendment remains consistent with state minimum standards, with the July 2002 Environmental Impact Report, and with the terms and conditions in the current SWFP. Therefore, filing the JTD Amendment will not require a revision of the May 2, 2003 SWFP. The LEA has determined that the existing SWFP adequately governs the continued operations at the facility and no change is necessary.

If you have any questions regarding this matter, please contact me at (805) 681-4942.

Sincerely,

Lisa Sloan
Senior Environmental Health Specialist

Enclosures

cc: Mark Schleich, RRWM
Dianne Ohiosumua, CIWMB
Martin Fletcher, RWQCB

Imelda Cragin, RRWM
Peter Jan, CIWMB
solidwas\tajiguas\JTDAmendDec2008.doc

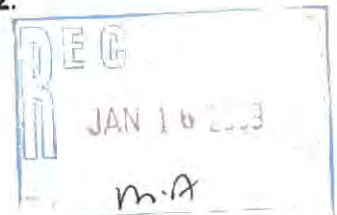

COUNTY OF SANTA BARBARA
PUBLIC WORKS DEPARTMENT
123 East Anapamu Street
Santa Barbara, CA 93101
805\568-3000 FAX 805\568-3019



SCOTT D. MCGOLPIN
Director

RECEIVED

December 12, 2008

DEC 12 2008

Lisa Sloan
Santa Barbara County Public Health Department
Environmental Health Services Division
225 Camino del Remedio
Santa Barbara, CA 93110

ENVIRONMENTAL HEALTH
SERVICES

SUBJECT: APPLICATION FOR A SOLID WASTE FACILITY PERMIT – PERMIT REVIEW MINOR CLARIFICATIONS, AND REVISED PAGES OF JOINT TECHNICAL DOCUMENT TAJIGUAS LANDFILL - SWFP 42-AA-0015

Dear Ms. Sloan:

Attached please find an Application for a Solid Waste Facility Permit (SWFP) – Permit Review Minor Clarifications to the Joint Technical Document (JTD) for the Tajiguas Landfill. Also, please find three copies of the pages that have changed in the revised JTD dated December 2007. The revisions to the December 2007 JTD reflect changes that have occurred at the landfill between March 2003 and September 2007.

These revisions were made in response to the May 2, 2008 letter from the Local Enforcement Agency (LEA), who requested that minor clarifications be made within the December 2007 JTD. The LEA also verbally requested that Section G. Storage Practices in the Odor Impact Minimization Plan (OIMP) in Appendix H be updated to reflect operational practices at the Tajiguas Landfill.

The revised pages of the December 2007 JTD include the following items:

- Revised Appendix H, Page 8. [Please replace only Page 8 of the OIMP in Appendix H with the attached revised Page 8 of the OIMP (do not remove the appendices)].
- Revised Figure 2 – Operational Area [Please replace Figure 2 with the attached revised Figure 2.]
- Revised Drawings 4 – Site Map [Please replace Drawing 4 with the attached revised Drawing 4.]

Upon receipt of the approval of the revised SWFP application and the revised pages of the December 2007 JTD, the SWFP and JTD currently on file at the Tajiguas Landfill will be updated. A copy of the revised pages to the December 2007 JTD will also be forwarded to the California Regional Water Quality Control Board.

AA/EEO Employer

Thomas D. Fayram, Deputy Director

Dacé B. Morgan, Deputy Director

Mark A. Schleich, Deputy Director

Rochelle Camozzi, Chief Financial Officer

Michael B. Emmons, County Surveyor

www.publicworkssb.org

Ms. Lisa Sloan

SUBJECT: APPLICATION FOR A SOLID WASTE FACILITY PERMIT – PERMIT REVIEW MINOR
CLARIFICATIONS, AND REVISED PAGES OF JOINT TECHNICAL DOCUMENT TAJIGUAS
LANDFILL - SWFP 42-AA-0015

December 12, 2008

Page 2

Please contact me at 882-3613, if you have any questions regarding the application for a SWFP – Permit Review Minor Clarifications to the JTD for the Tajiguas Landfill or the enclosed revised pages to the Tajiguas Landfill December 2007 JTD. Thank you very much for working with us on this matter.

Sincerely,

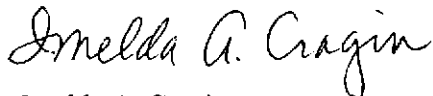

Imelda A. Cragin
Permitting & Engineering Manager

IAC:ic
Attachments

cc: John Haines – County of Santa Barbara
Mark Schleich – County of Santa Barbara
Chris Wilson – County of Santa Barbara
Project No. 129900

APPLICATION FOR SOLID WASTE FACILITY PERMIT/WASTE DISCHARGE REQUIREMENTS

CIWMB E-1-77 (Rev. 8-04)

NOTE: This form has been developed for multiple uses. It is the transmittal sheet for documents required to be submitted to the appropriate agency. Please refer to the attached instructions for definitions of terms and for completing this application form in a complete and correct manner.

FOR OFFICIAL USE ONLY

SWIS NUMBER:	FILING FEE:	RECEIPT NUMBER:	DATE RECEIVED: <u>12-12-2008</u>
DATE ACCEPTED: <u>01-08-2008</u>	DATE REJECTED:	ACCEPTANCE DATE OF INCOMPLETE APPLICATION: DATE DUE:	

Part 1. GENERAL INFORMATION

A. ENFORCEMENT AGENCY: <u>Santa Barbara County Environmental Health</u>	B. COUNTY: <u>Santa Barbara County</u>
----------------------------------------------------------------------------	-------------------------------------------

C. TYPE OF APPLICATION (Check one box only):

- 1. NEW SWFP and/or WDRS
- 2. REVISION OF SWFP and/or WDRS
- 3. EXEMPTION and/or WAIVER
- 4. PERMIT REVIEW
- 5. AMENDMENT OF APPLICATION
- 6. RFI/ROWD/JTD AMENDMENTS

Part 2. FACILITY DESCRIPTION

A. NAME OF FACILITY:

Tajiguas Sanitary Landfill

B. LOCATION OF FACILITY:

1. PHYSICAL ADDRESS OR LOCATION AND ZIP CODE:

14470 Calle Real, Goleta, CA 93117

2. LATITUDE AND LONGITUDE:

34°28'54"N, 120°07'40"W

3. LEGAL DESCRIPTION OF PERMITTED BOUNDARY BY SECTION, TOWNSHIP, RANGE, BASE, AND MERIDIAN, IF SURVEYED:

Section 28 & 33 T5N, R31W S.B.B.M

C. TYPE OF ACTIVITY: (Check applicable boxes):

- 1. DISPOSAL
a. TYPE: municipal solid waste
- 2. COMPOSTING
a. TYPE: _____
- 3. TRANSFORMATION
- 4. TRANSFER/PROCESSING FACILITY
□ CHECK HERE IF RECYCLABLE MATERIALS ARE RECOVERED PRIOR TO TRANSFER/PROCESSING.
- 5. OTHER (describe): _____

D. CONFORMANCE FINDING INFORMATION (CIWMP):

- 1. FACILITY IS IDENTIFIED IN (Check one):
 - SITING ELEMENT DATE OF DOCUMENT June 1998 PAGE # 4-1, 4-4
 - NONDISPOSAL FACILITY EL DATE OF DOCUMENT _____ PAGE # _____
- 2. FACILITY IS NOT REQUIRED TO BE IDENTIFIED IN SITING ELEMENT OR NONDISPOSAL FACILITY ELEMENT

E. TYPE OF PERMITTED WASTES TO BE RECEIVED: (Check applicable boxes):

- 1. AGRICULTURAL
- 2. ASBESTOS Friable Non-friable
- 3. ASH
- 4. AUTO SHREDDER
- 5. COMPOSTABLE MATERIAL (describe): _____
- 6. CONSTRUCTION/DEMOLITION
- 7. CONTAMINATED SOILS
- 8. DEAD ANIMALS
- 9. INDUSTRIAL
- 10. INERT
- 11. LIQUIDS
- 12. MIXED/MUNICIPAL SOLID WASTE
- 13. SEWAGE SLUDGE
- 14. TIRES
- 15. OTHER (describe): _____

Part 3. FACILITY INFORMATION

A. PROPOSED CHANGE (Check applicable box(es)):

- 1. DESIGN (describe): _____
- 2. OPERATION (describe): _____
- 3. OWNER, OPERATOR, ADDRESS, AND/OR FACILITY NAME CHANGE (describe): _____
- 4. OTHER (describe): Five Year Permit Review - JTD Minor Clarifications

B. FACILITY INFORMATION:

1. INFORMATION APPLICABLE TO ALL FACILITIES:

- a. PEAK DAILY TONNAGE OR CUBIC YARDS 1500
 - 1) DISPOSAL/TRANSER (unit) 1292
 - 2) OTHER (unit) 208
- b. DAILY DESIGN TONNAGE (TPD) 1500
- c. FACILITY SIZE (acres) 357
- d. PEAK TRAFFIC VOLUME PER DAY (vpd) 120
- e. DAYS AND HOURS OF OPERATION Monday-Tuesday 7:00 A.M.-5:00 P.M. Wednesday-Saturday 7:00 A.M.-4:00 P.M.

2. ADDITIONAL INFO. REQUIRED FOR COMPOSTING FACILITIES ONLY:

- a. SITE STORAGE CAPACITY (cu yds) _____

3. ADDITIONAL INFORMATION REQUIRED FOR LANDFILLS ONLY:

- a. AVERAGE DAILY TONNAGE (TPD) 729 (MSW)
- b. SITE CAPACITY CURRENTLY PERMITTED (Airspace) (cu yds) 23,300,000
- c. SITE CAPACITY PROPOSED (Airspace) (cu yds) 23,300,000
- d. SITE CAPACITY USED TO DATE (Airspace) (cu yds) 16,100,000
- e. SITE CAPACITY REMAINING (Airspace) (cu yds) 7,200,000
- f. DATE OF CAPACITY INFORMATION (Date) (See instructions): September 25, 2007
- g. LAST PHYSICAL SITE SURVEY (Date) September 25, 2007
- h. ESTIMATED CLOSURE DATE (month and year) January 2022
- i. DISPOSAL FOOTPRINT (acres) 118
- j. SITE CAPACITY PLANNED (cu yds) 23,300,000
- k. 1. (i) IN-PLACE WASTE DENSITY (lbs of waste per cu yd of waste) 1067
AND
(ii) WASTE-TO-COVER RATIO (Estimated) (v:v) _____
OR
2. AIRSPACE UTILIZATION FACTOR (tons of waste per cu yd of landfill airspace) 0.5335

Part 4. SOURCE OF WATER SUPPLY (Check applicable boxes)

- A. MUNICIPAL OR UTILITY SERVICE: _____
- B. INDIVIDUAL (wells): Water Well #4
- C. SURFACE SUPPLY:
 - 1. NAME OF STREAM, LAKE, ETC.: _____
 - 2. TYPE OF WATER RIGHTS:
 - RIPARIAN
 - APPROPRIATION
 - 3. STATE PERMIT OR LICENSE NUMBER, IF APPLICABLE: _____

Part 5. COMPLIANCE WITH CALIFORNIA ENVIRONMENTAL QUALITY ACT (CEQA) (Check applicable boxes)

A. CHECK BOX(ES) IF ENVIRONMENTAL DOCUMENT WAS OR WILL BE PREPARED FOR THIS PROJECT AND PROVIDE THE STATE CLEARINGHOUSE NUMBER (SCH#):

ENVIRONMENTAL IMPACT REPORT (EIR) SCH# 98041003

NEGATIVE DECLARATION (ND)/MITIGATED NEGATIVE DECLARATION (MND) SCH# _____

ADDENDUM TO (Identify environmental document) _____ SCH# _____

B. IF ENVIRONMENTAL DOCUMENT(S) WAS NOT PREPARED, PLEASE PROVIDE THE FOLLOWING INFORMATION:

CATEGORICAL/STATUTORY EXEMPTION (CE/SE)
EXEMPTION TYPE _____ GUIDELINE # _____

Part 6. LIST OF ATTACHMENTS (Fill in the date for each document checked)

A. REQUIRED WITH ALL APPLICATION SUBMITTALS:

RFI/IJD December 2007

LOCAL USE/PLANNING PERMITS _____

LOCATION MAP _____

MITIGATION MONITORING IMPLEMENTATION SCHEDULE _____

ENVIRONMENTAL DOCUMENT(S):

EIR _____

MND/ND _____

EXEMPTION _____

ADDENDUM _____

B. ADDITIONAL REQUIRED DOCUMENTS FOR LANDFILLS ONLY:

OPERATING LIABILITY FINANCIAL MECHANISM _____

FINANCIAL RESPONSIBILITY DOCUMENTATION _____

CLOSURE/POST CLOSURE MAINTENANCE PLAN _____

LANDFILL CAPACITY SURVEY RESULTS (see instructions) _____

PRELIMINARY _____
 FINAL _____

C. IF APPLICABLE:

REPORT OF WASTE DISCHARGE _____

DEPT. OF HEALTH SERVICES PERMIT _____

CONTRACT AGREEMENTS _____

SWAT (Air and water) _____

STORMWATER PERMIT APPLICATION _____

WETLANDS PERMITS _____

NPDES PERMIT APPLICATION _____

VERIFICATION OF FIRE DISTRICT COMPLIANCE _____

OTHER _____

Part 7. OWNER INFORMATION (For disposal site, if operator is different from land owner, attach lease or other agreement)

TYPE OF BUSINESS:

SOLE PROPRIETORSHIP

PARTNERSHIP

CORPORATION

GOVERNMENT AGENCY

OWNER(S) OF LAND

(Name):

Santa Barbara County Public Works Department

ADDRESS, CITY, STATE, ZIP

130 E. Victoria Street, Suite 100, Santa Barbara, CA 93101

SSN OR TAX ID #

95-600-2833

TELEPHONE #:

(805) 882-3600

FAX #:

(805) 992-3601

E-MAIL ADDRESS:

schleich@cosbpw.net

CONTACT PERSON (Print Name):

Mark A. Schleich

Part 8. OPERATOR INFORMATION (For disposal site, if operator is different from land owner, attach lease or other agreement)

TYPE OF BUSINESS:

SOLE PROPRIETORSHIP PARTNERSHIP CORPORATION GOVERNMENT AGENCY

FACILITY OPERATOR(S)
(Name):

Santa Barbara County Public Works Department
ADDRESS, CITY, STATE, ZIP
130 East Victoria Street, Suite 100, Santa Barbara, CA 93101

SSN OR TAX ID #:

95-600-2833

TELEPHONE #:
(805) 882-3600

FAX #:
(805) 882-3601

E-MAIL ADDRESS:

schleich@cosbpw.net
CONTACT PERSON (Print Name):

Mark A. Schleich

ADDRESS WHERE LEGAL NOTICE MAY BE SERVED:

Part 9. SIGNATURE BLOCK

Owner:

I certify under penalty of perjury that the information I provided for this application and for any attachments is true and accurate to the best of my knowledge and belief. I am aware that the operator intends to operate a solid waste facility at the site specified above pursuant to this application and understand that I may be responsible for the site should the operator fail to meet applicable requirements.

SIGNATURE (LAND OWNER OR AGENT):

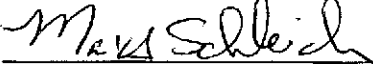

PRINTED NAME:

Mark A. Schleich

TITLE:
Deputy Director - Public Works Department

DATE:
December 12, 2008

Operator:

I certify under penalty of perjury that the information contained in this application and all attachments are true and accurate to the best of my knowledge and belief.

SIGNATURE (FACILITY OPERATOR OR AGENT):



PRINTED NAME:

Mark A. Schleich

TITLE:
Deputy Director - Public Works Department

DATE:
December 12, 2008

Part 10. OTHER (Attach additional sheets to explain any responses that need clarification).

water sampling is conducted in accordance with the landfill's waste discharge requirements/monitoring and reporting program.

E. Pad Maintenance

All green and wood waste received at the landfill is stored and processed on an asphalt pad. Landfill personnel regularly inspect the condition of the pad for any evidence of ponding or drainage problems. Standing water that is discovered is immediately removed, and any damage to the pad repaired.

F. Wastewater Pond Controls

All storm/waste water is conveyed to the designated drainage channel and sampled in accordance with the landfill's waste discharge requirements/monitoring and reporting program.

G. Storage Practices

1. Storage Time

a. Feedstock

Feedstock material will be processed within seven (7) days of receipt. Temperatures of the unground greenwaste are monitored to assure that temperatures do not exceed 122 degrees Fahrenheit (the temperature at which composting of the material needs to be initiated).

b. Processed Material

Processed material is either removed from the site, or used on-site for landscaping and erosion control within the seven days of the receipt of the feedstock material.

2. Pile Geometry

a. Feedstock

Greenwaste received for processing is typically stored in a pile ranging in size from 12-15 feet in height, 35-40 feet in width, and 50-75 feet in length. Any wood waste received at the landfill is usually in the form of tree trunks, which are stored separately until they can be ground.

b. Processed Material

Greenwaste that is processed is stored on the pad until removed. The processed clean greenwaste pile may range in size from 10-15 feet in height, 20-25 feet in width, and 30-50 feet in length.

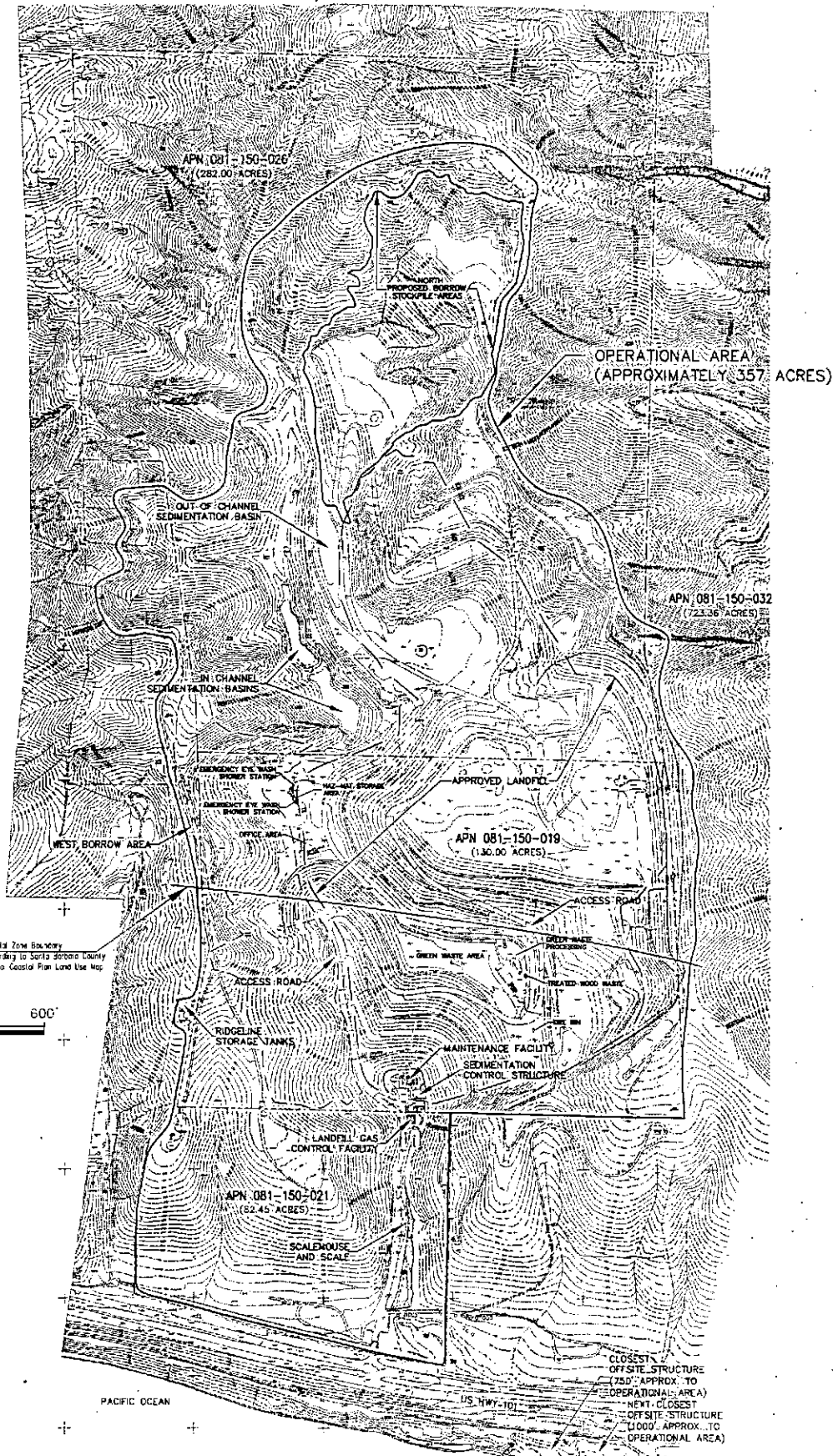

COUNTY OF SANTA BARBARA
 RESOURCE RECOVERY & WASTE MGT

Figure 2
 TAJIGUAS LANDFILL
 OPERATIONAL AREA MAP

COUNTY OF SANTA BARBARA RESOURCE RECOVERY & WASTE MGMT. FIGURE 2: TAJIGUAS LANDFILL OPERATIONAL AREA MAP. DATE: 12/15/2011. SCALE: 1" = 600'.

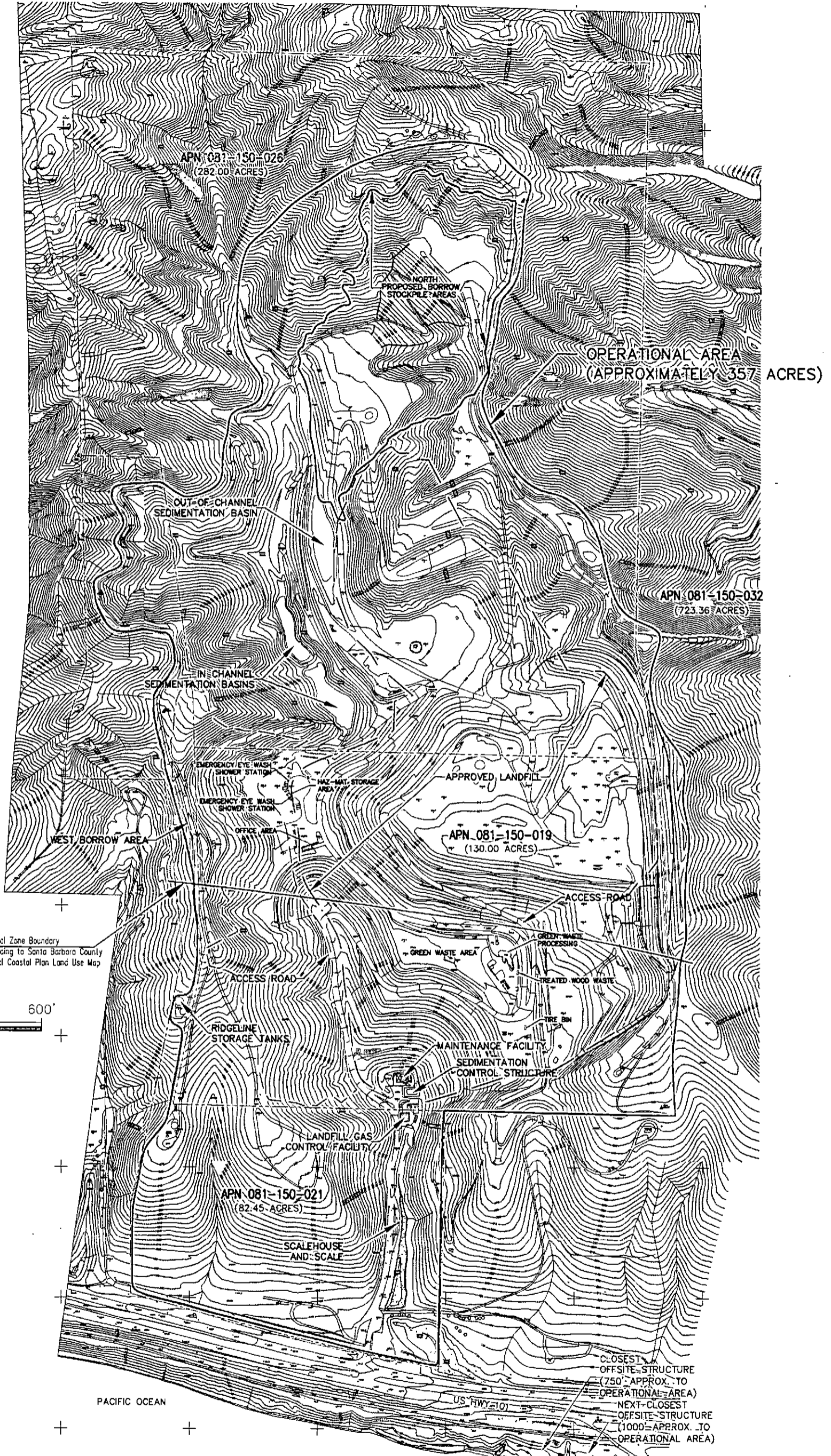

2,006,300
2,007,700
2,007,000
2,008,200
2,009,500
2,010,700
2,012,000
2,013,200
2,014,500
2,015,800



Coastal Zone Boundary
According To Santa Barbara County
Official Coastal Plan Land Use Map

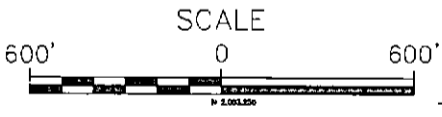

COUNTY OF SANTA BARBARA
RESOURCE RECOVERY & WASTE MGT

Figure 2
TAJIGUAS LANDFILL
OPERATIONAL AREA MAP

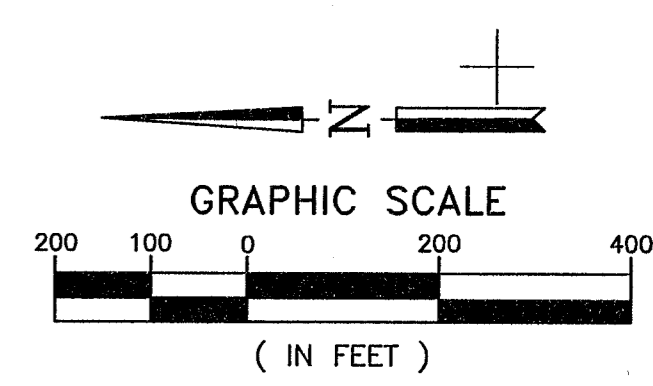
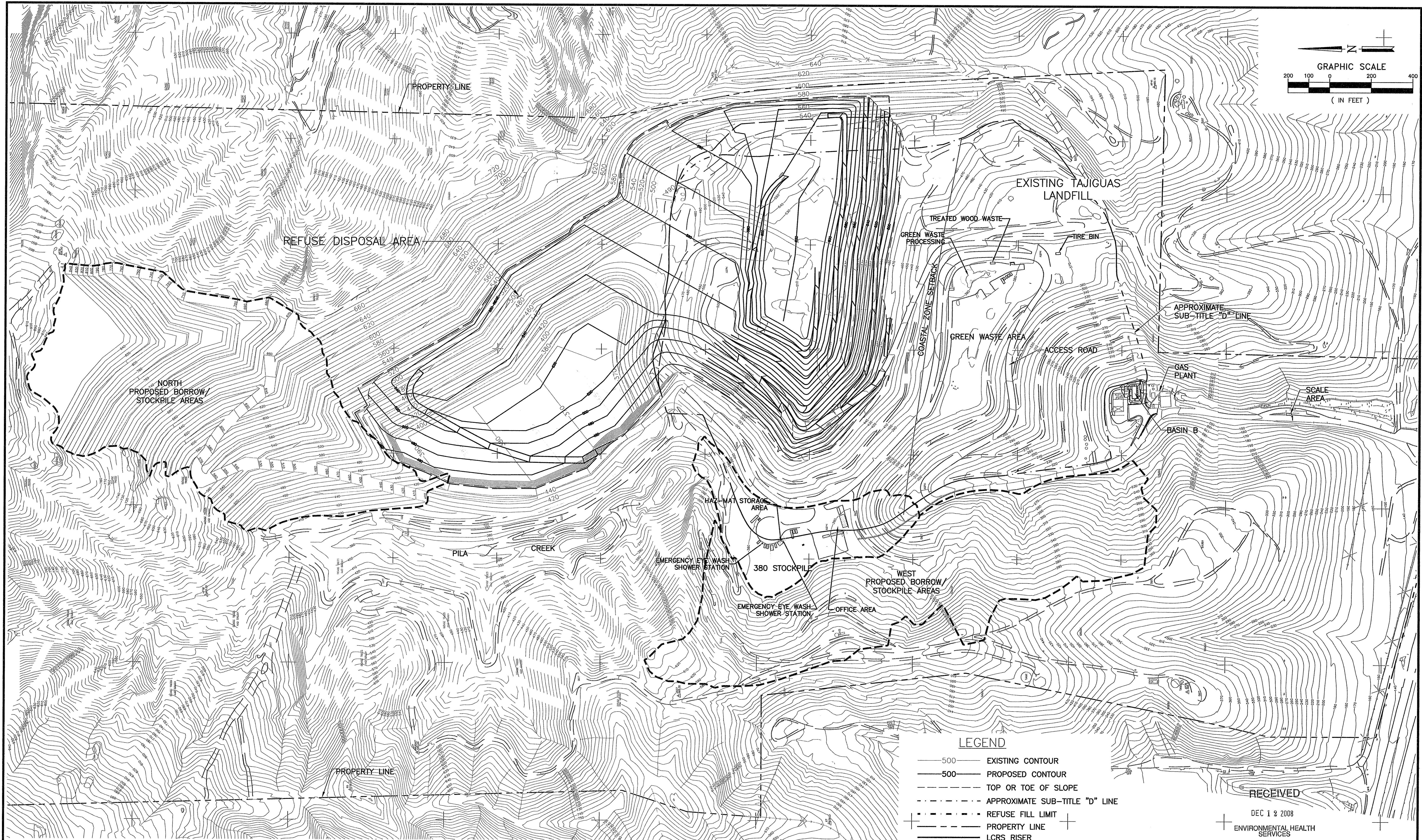

LEGEND

— 500 —	EXISTING CONTOUR
— 500 —	PROPOSED CONTOUR
- - - - -	TOP OR TOE OF SLOPE
- - - - -	APPROXIMATE SUB-TITLE "D" LINE
- - - - -	REFUSE FILL LIMIT
- - - - -	PROPERTY LINE
- - - - -	LCRS RISER

RECEIVED

DEC 12 2008

ENVIRONMENTAL HEALTH SERVICES

DATE OF TOPOGRAPHY: 09-2007
GRADING DESIGN PER B.A.S.

NO.	REVISION DESCRIPTION	DATE

APPROVAL RECOMMENDED	DATE

PREPARED BY:
Solid Waste Team Engineering
268 NORTH LINCOLN AVENUE, SUITE #1
CORONA, CALIFORNIA, 92882
PREPARED UNDER THE SUPERVISION OF:
MICHAEL A. CULLINANE, R.C.E. No 41981

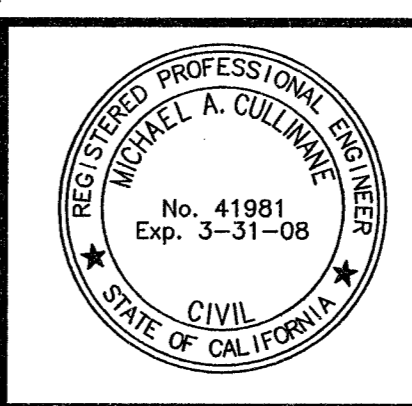

RESOURCE RECOVERY AND WASTE MANAGEMENT
TAJIGUAS LANDFILL

SITE MAP

DESIGNED BY :	SCALE : AS SHOWN
DRAWN BY :	DATE :
CHECKED BY :	DATE :
APPROVED BY :	DATE :

FILE NO.: JTD04REV1.DWG
DRAWING 4