

ATTACHMENT E: EMISSIONS REPORT

JERROLD T. BUSHBERG Ph.D., DABMP, DABSNM
◆HEALTH AND MEDICAL PHYSICS CONSULTING◆

7784 Oak Bay Circle Sacramento CA 95831-5800
(800) 760-8414-jbushberg@hampe.com

Christopher D. Hourigan
NextG Networks
2216 O'Toole Ave
San Jose CA 95131

April 29, 2009

Introduction

At your request, I have reviewed the technical specifications and calculated the maximum radiofrequency, (RF), power density from the Phazar antenna model #AWS360-1710-7-T0-N planned for the Metro PCS wireless telecommunications facilities in Santa Barbara and Goleta, CA. Detailed antenna specifications are provided in attachment 1. This analysis is applicable to any situation in which this antenna is the only RF transmission source located on a light standard, utility pole or similar structure, where the distance from the antenna center to the ground is at least 26 feet and the maximum input power is 20.0 watts. The antenna planned for use in this network is omnidirectional, with a gain of 7 dBi, and is designed to transmit within a bandwidth between approximately 1,710 and 2,155 MHz.

Calculation Methodology

Calculations were made in accordance with the cylindrical model recommendations for near-field analysis contained in the Federal Communications Commission, Office of Engineering and Technology Bulletin 65 entitled "Evaluating Compliance with FCC-Guidelines for Human Exposure to Radiofrequency Electromagnetic Fields." Several assumptions were made in order to provide the most conservative or "worse case" projections of power densities. Calculations were made assuming that all channels were operating simultaneously at their maximum design effective radiated power. Attenuation (weakening) of the signal that would result from surrounding foliage or buildings was ignored. Buildings or other structures can reduce the signal strength by a factor of 10 (i.e., 10 dB) or more depending upon the construction material. In addition, for the far field analysis of ground level RF exposure, the ground or other surfaces were considered to be perfect reflectors (which they are not) and the RF energy was assumed to overlap and interact constructively at all locations (which they would not) thereby resulting in the calculation of the maximum potential exposure. In fact, the accumulations of all these very conservative assumptions will significantly overestimate the actual exposures that would typically be expected from such a facility. However, this method is a prudent approach that errs on the side of safety.

RF Safety Standards

The two most widely recognized standards for protection against RF field exposure are those published by the American National Standards Institute (ANSI) C95.1 and the National Council on Radiation Protection and measurement (NCRP) report #86.

The NCRP is a private, congressionally chartered institution with the charge to provide expert analysis of a variety of issues (especially health and safety recommendations) on radiations of all forms. The scientific analyses of the NCRP are held in high esteem in the scientific and regulatory community both nationally and internationally. In fact, the vast majority of the radiological health regulations currently in existence can trace their origin, in some way, to the recommendations of the NCRP.

All RF exposure standards are frequency-specific, in recognition of the differential absorption of RF energy as a function of frequency. The most restrictive exposure levels in the standards are associated with those frequencies that are most readily absorbed in humans. Maximum absorption occurs at approximately 80 MHz in adults. The NCRP maximum allowable continuous occupational exposure at this frequency is $1,000 \mu\text{W}/\text{cm}^2$. This compares to $5,000 \mu\text{W}/\text{cm}^2$ at the most restrictive of the PCS frequencies (~1,800 MHz) that are absorbed much less efficiently than exposures in the VHF TV band.

The traditional NCRP philosophy of providing a higher standard of protection for members of the general population compared to occupationally exposed individuals, prompted a two-tiered safety standard by which levels of allowable exposure were substantially reduced for "uncontrolled" (e.g., public) and continuous exposures. This measure was taken to account for the fact that workers in an industrial environment are typically exposed no more than eight hours a day while members of the general population in proximity to a source of RF radiation may be exposed continuously. This additional protection factor also provides a greater margin of safety for children, the infirmed, aged, or others who might be more sensitive to RF exposure. After several years of evaluating the national and international scientific and biomedical literature, the members of the NCRP scientific committee selected 931 publications in the peer-reviewed scientific literature on which to base their recommendations. The current NCRP recommendations limit continuous public exposure at PCS frequencies to $1,000 \mu\text{W}/\text{cm}^2$.

The 1992 ANSI standard was developed by Scientific Coordinating Committee 28 (SCC 28) under the auspices of the Institute of Electrical and Electronic Engineers (IEEE). This standard, entitled "IEEE Standards for Safety Levels with Respect to Human Exposure to Radio Frequency Electromagnetic Fields, 3 kHz to 300 GHz" (IEEE C95.1-1991), was issued in April 1992 and subsequently adopted by ANSI. A revision of this standard (C95.1-2005) was completed in October 2005 by SCC 39 the IEEE International Committee on Electromagnetic Safety. Their recommendations are similar to the NCRP recommendation for the maximum permissible exposure (MPE) to the public PCS frequencies ($950 \mu\text{W}/\text{cm}^2$ for continuous exposure at 1,900 MHz) and incorporates the convention of providing for a greater margin of safety for public as compared with occupational exposure. Higher whole body exposures are allowed for brief periods provided that no 30 minute time-weighted average exposure exceeds these aforementioned limits.

On August 9, 1996, the Federal Communications Commission (FCC) established a RF exposure standard that is a hybrid of the current ANSI and NCRP standards. The maximum permissible exposure values used to assess environmental exposures are those of the NCRP (i.e., maximum public continuous exposure at PCS frequencies of $1,000 \mu\text{W}/\text{cm}^2$). The FCC issued these standards in order to address its responsibilities under the National Environmental Policy Act (NEPA) to consider whether its actions will "significantly affect the quality of the human environment." In as far as there was no other standard issued by a federal agency such as the Environmental Protection Agency (EPA), the FCC utilized their rulemaking procedure to consider which standards should be adopted. The FCC received thousands of pages of comments over a three-year review period from a variety of sources including the public,

academia, federal health and safety agencies (e.g., EPA & FDA) and the telecommunications industry. The FCC gave special consideration to the recommendations by the federal health agencies because of their special responsibility for protecting the public health and safety. In fact, the maximum permissible exposure (MPE) values in the FCC standard are those recommended by EPA and FDA. The FCC standard incorporates various elements of the 1992 ANSI and NCRP standards which were chosen because they are widely accepted and technically supportable. There are a variety of other exposure guidelines and standards set by other national and international organizations and governments, most of which are similar to the current ANSI/IEEE or NCRP standard, figure one.

The FCC standards "Guidelines for Evaluating the Environmental Effects of Radiofrequency Radiation" (Report and Order FCC 96-326) adopted the ANSI/IEEE definitions for controlled and uncontrolled environments. In order to use the higher exposure levels associated with a controlled environment, RF exposures must be occupationally related (e.g., PCS company RF technicians) and they must be aware of and have sufficient knowledge to control their exposure. All other environmental areas are considered uncontrolled (e.g., public) for which the stricter (i.e., lower) environmental exposure limits apply. All carriers were required to be in compliance with the new FCC RF exposure standards for new telecommunications facilities by October 15, 1997. These standards applied retroactively for existing telecommunications facilities on September 1, 2000.

The task for the physical, biological, and medical scientists that evaluate health implications of the RF data base has been to identify those RF field conditions that can produce harmful biological effects. No panel of experts can guarantee safe levels of exposure because safety is a null concept, and negatives are not susceptible to proof. What a dispassionate scientific assessment can offer is the presumption of safety when RF field conditions do not give rise to a demonstrable harmful effect.

Summary & Conclusions

All wireless transmission systems utilizing Phazar antenna model #AWS360-1710-7-T0-N and operating with the characteristics specified above will be in full compliance with FCC RF public safety exposure standards. These transmitters, by design and operation, are low-power devices. Even under maximal exposure conditions in which all the channels are operating at full power, the maximum exposure next to and at the elevation of the antenna will not result in RF exposures in excess of 57.2% of the FCC public safety RF exposure standard for these frequencies (see appendix A-1). An information sign containing appropriate contact information and indicating that RF exposures do not exceed the public MPE should be placed near the antenna (see appendix A-2). The maximum RF exposure at ground level will not result in RF exposures in excess of 0.3% of the FCC public safety standard (see appendix A-3).

A chart of the electromagnetic spectrum and a comparison of RF power densities from various common sources is presented in figures two and three respectively in order to place exposures from wireless telecommunications systems in perspective. It is important to realize that the FCC maximum allowable exposures are not set at a threshold between safety and known hazard but rather at 50 times below a level that the majority of the scientific community believes may pose a health risk to human populations. Thus the previously mentioned maximum exposure, next to and at the elevation of the antenna, represents a "safety margin" from this threshold of potentially adverse health effects of more than 87 times. The maximum public exposure at ground level is more than 16,660 times below this threshold of potentially adverse health effects.

Given the low levels of radiofrequency fields that would be generated from wireless installations conforming to the configuration specified above, and given the evidence on RF biological effects in a large data base, there is no scientific basis to conclude that harmful effects will attend the utilization of these proposed wireless telecommunications facilities. This conclusion is supported by a large numbers of scientists that have participated in standard-setting activities in the United States who are overwhelmingly agreed that RF radiation exposure below the FCC exposure limits has no demonstrably harmful effects on humans.

These findings are based on my professional evaluation of the scientific issues related to the health and safety of non-ionizing electromagnetic radiation and my analysis of the technical specification as provided by NextG Networks. The opinions expressed herein are based on my professional judgement and are not intended to necessarily represent the views of any other organization or institution. Please contact me if you require any additional information.

Sincerely,

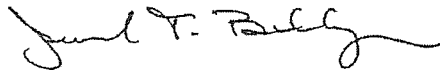
A handwritten signature in black ink, appearing to read "Jerrold T. Bushberg". The signature is fluid and cursive, with a long horizontal stroke at the end.

Jerrold T. Bushberg Ph.D., DABMP, DABSNM
Diplomate, American Board of Medical Physics (DABMP)
Diplomate, American Board of Science in Nuclear Medicine (DABSNM)

Enclosures: Figures 1-3; Attachment 1; Appendix A-1, A-2, A-3 and Statement of Experience.

Public Safety Exposure Standards at PCS (~1,800 MHz) Frequencies

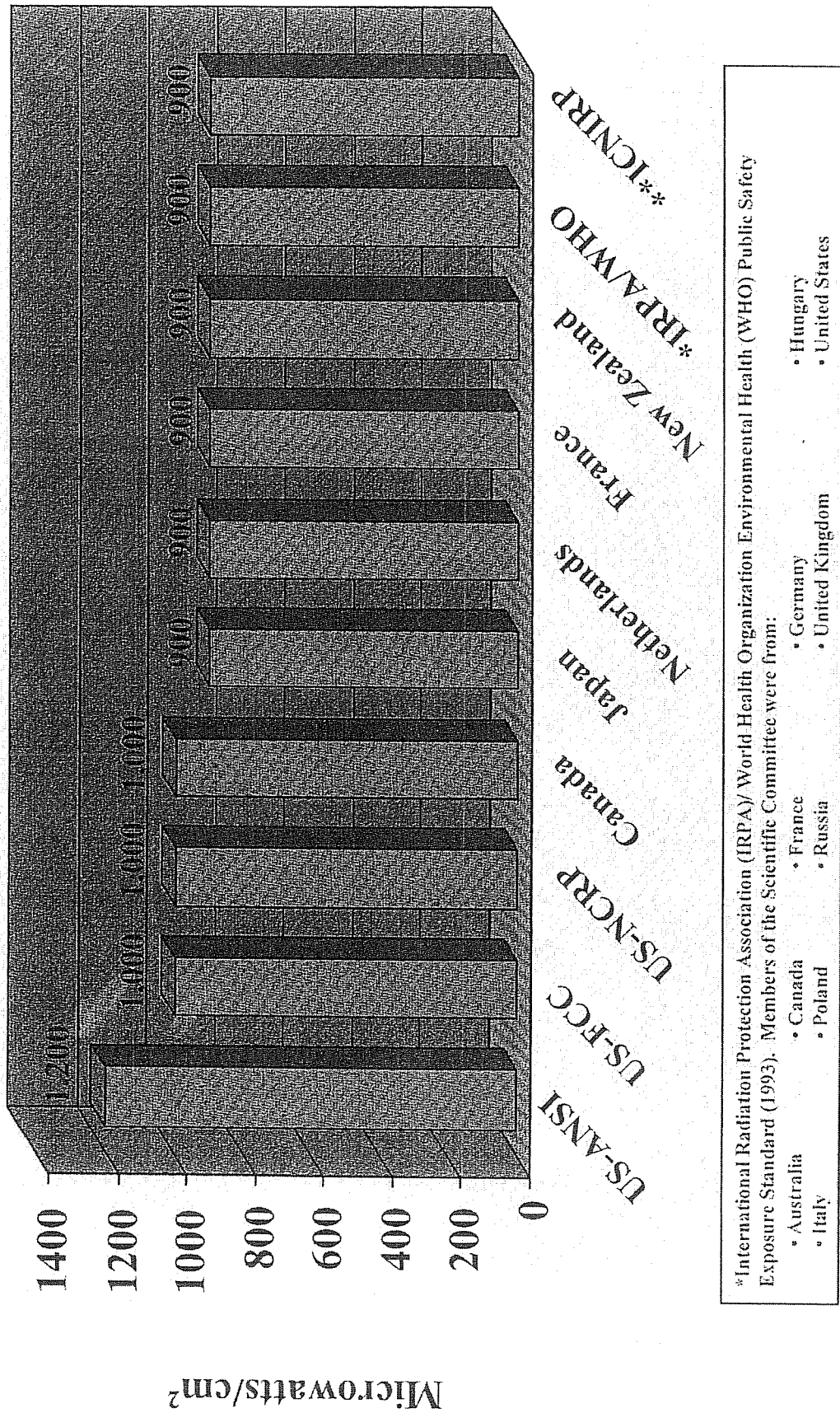

*International Radiation Protection Association (IRPA)/ World Health Organization Environmental Health (WHO) Public Safety Exposure Standard (1993). Members of the Scientific Committee were from:

- Australia
- Italy
- Canada
- Poland
- France
- Russia
- Germany
- United Kingdom
- Hungary
- United States

**International Commission on Non-Ionizing Radiation Protection Public Safety Exposure Standard (1998). Members of the Scientific Committee were from:

- Australia
- Italy
- Sweden
- Poland
- France
- Austria
- Germany
- United Kingdom
- Hungary
- United States
- Finland
- Japan

Figure 1

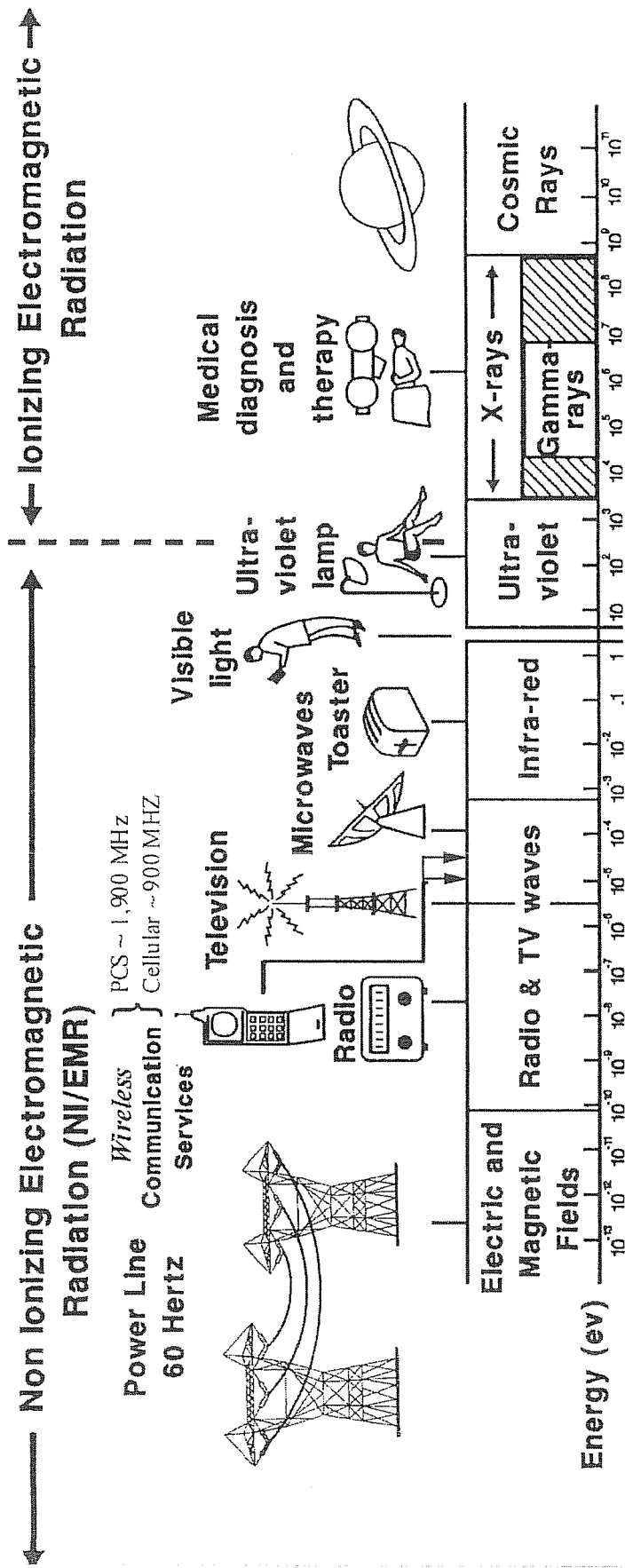

The Electromagnetic Spectrum

Figure 2

Typical Exposure from Various Radio Frequency / Microwave Sources

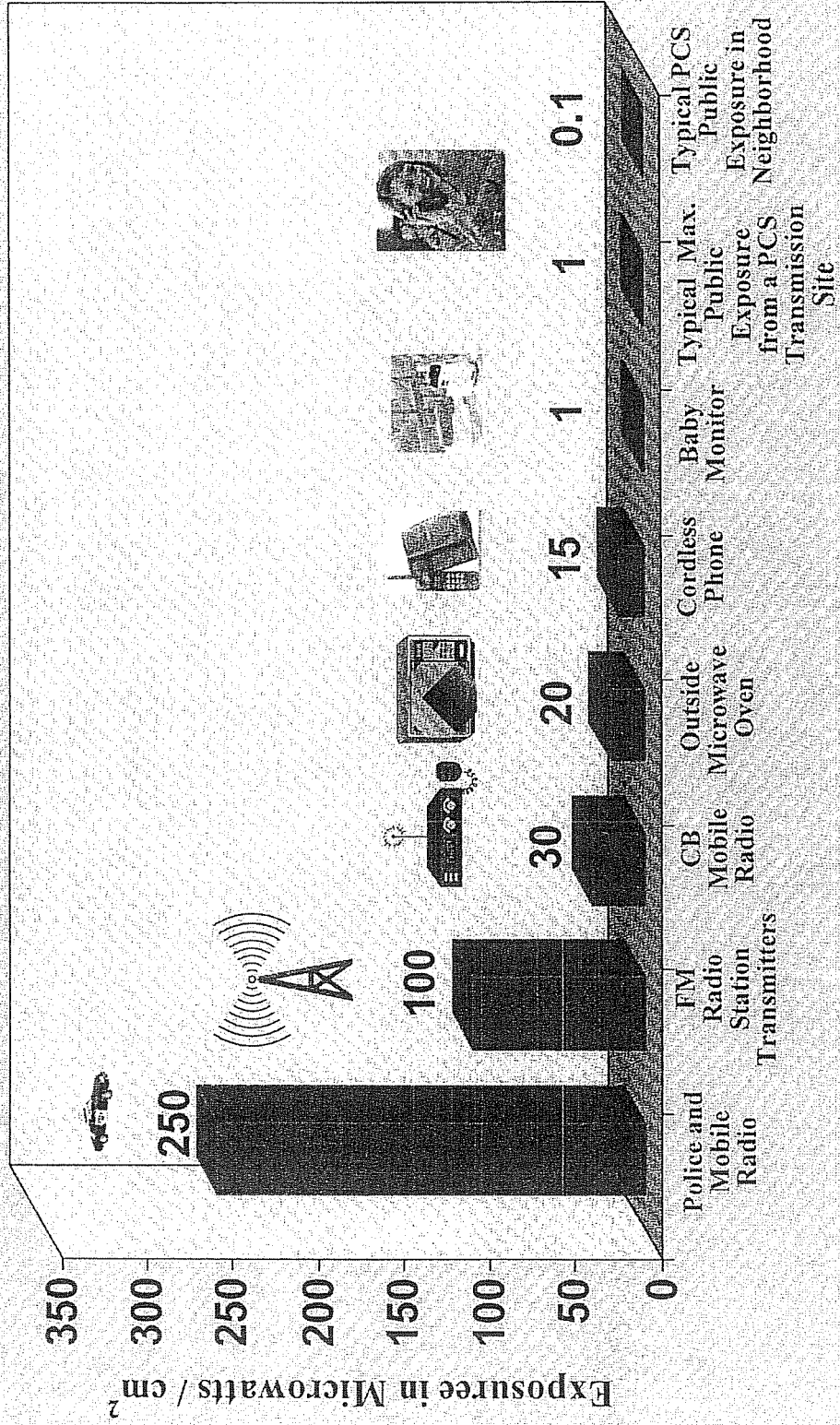

Figure 3

Attachment 1

**Example Utility Pole with
Antenna Mounted on Bracket**



NextG Networks, Inc.
 MPC1035CA-GOLN044
GOLETA
GOLETA, CA 93117

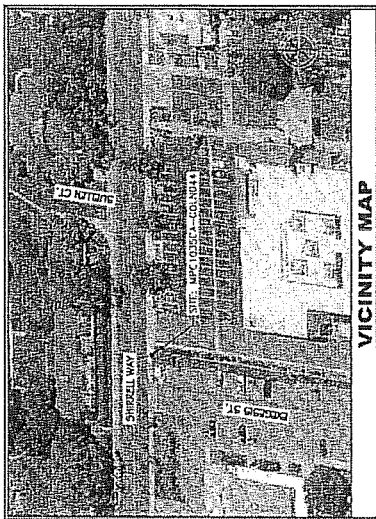

VICINITY MAP



PROJECT DESCRIPTION

FOR THE PROJECT OF THE PROJECT, THE CITY OF GOLETA HAS APPOINTED THE CONSULTANT TO PROVIDE PROFESSIONAL ENGINEERING SERVICES FOR THE PROJECT. THE CONSULTANT SHALL BE RESPONSIBLE FOR THE DESIGN AND CONSTRUCTION OF THE PROJECT. THE CONSULTANT SHALL BE RESPONSIBLE FOR THE DESIGN AND CONSTRUCTION OF THE PROJECT. THE CONSULTANT SHALL BE RESPONSIBLE FOR THE DESIGN AND CONSTRUCTION OF THE PROJECT.

PROJECT SCOPE

THIS PROJECT IS THE DESIGN AND CONSTRUCTION OF THE PROJECT. THE CONSULTANT SHALL BE RESPONSIBLE FOR THE DESIGN AND CONSTRUCTION OF THE PROJECT. THE CONSULTANT SHALL BE RESPONSIBLE FOR THE DESIGN AND CONSTRUCTION OF THE PROJECT.

CODE COMPLIANCE

THE OWNER HAS REQUESTED THAT THE CONSULTANT VERIFY THAT THE PROJECT COMPLIES WITH THE FOLLOWING CODES AND REGULATIONS:

- STATE PENNSYLVANIA
- NATIONAL FIRE PROTECTION ASSOCIATION (NFPA) 101
- INTERNATIONAL BUILDING CODE (IBC)
- INTERNATIONAL PLUMBING AND MECHANICAL CODE (IMC)
- INTERNATIONAL MECHANICAL CODE (IMC)

PROPERTY INFORMATION

OWNER: NEXT G NETWORKS INC.
 PROJECT: MPC1035CA-GOLN044
 ADDRESS: 1035 STATE STREET, GOLETA, CA 93117
 PROJECT NUMBER: 2009-001
 PROJECT DATE: 03/02/2009
 PROJECT TYPE: COMMERCIAL BUILDING
 PROJECT DESCRIPTION: COMMERCIAL BUILDING
 PROJECT SCOPE: COMMERCIAL BUILDING
 PROJECT VALUE: \$1,000,000
 PROJECT STATUS: IN PROGRESS
 PROJECT CONTACT: PROJECT MANAGER

PROJECT SUMMARY

<p>NextG Networks, Inc. 1035 STATE STREET GOLETA, CA 93117 TEL: 805.453.4100</p>	<p>PROJECT INFORMATION</p> <p>MPC1035CA-GOLN044 GOLETA, CA 93117</p>	<p>CURRENT ISSUE DATE: 03/02/2009</p>	<p>PROJECT DESCRIPTION</p>	<p>PROJECT INFORMATION</p>	<p>PREPARED BY:</p> <p>HP COMMUNICATIONS INC. 1035 STATE STREET GOLETA, CA 93117 TEL: 805.453.4100</p>	<p>NextG Networks, Inc. 1035 STATE STREET GOLETA, CA 93117 TEL: 805.453.4100</p>	<p>PROJECT INFORMATION</p>	<p>TITLE SHEET</p>	<p>1 OF 4</p>
---	---	---------------------------------------	----------------------------	----------------------------	---	---	----------------------------	--------------------	---------------

1-800-277-2810
 DIALM
 THE DESIGN AND CONSTRUCTION COMPANY

SHEET INDEX

SHEET NUMBER	TITLE	REV.
1	TITLE SHEET	0
2	FOUNDATION / STRUCTURE / MECHANICAL / ELECTRICAL	0
3	MECHANICAL	0
4	ELECTRICAL	0

DO NOT SCALE DRAWINGS

THIS DRAWING IS FOR INFORMATION ONLY. IT IS NOT TO BE USED FOR CONSTRUCTION. THE CONSULTANT SHALL BE RESPONSIBLE FOR THE DESIGN AND CONSTRUCTION OF THE PROJECT. THE CONSULTANT SHALL BE RESPONSIBLE FOR THE DESIGN AND CONSTRUCTION OF THE PROJECT.

GENERAL CONTRACTOR NOTES

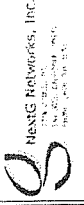

PROJECT INFORMATION
 PROJECT NO: 0310326-001004
 CLIENT: SBC TELECOM
 COUNTY: TARRANT

ISSUE DATE: 03/02/2009
 SUBMITTED BY: [Name]
 PROJECT: [Name]

NO.	DATE	DESCRIPTION

DESIGNED BY: HP COMMUNICATIONS INC.
 13344 Meridian 2nd St.
 Dallas, TX 75244
 PHONE: 214 715 7000

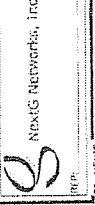

SHEET TITLE: PROFILES

TICKET # [Blank] 2 OF 4

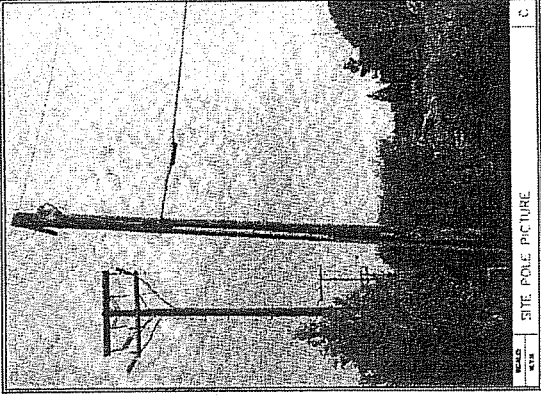
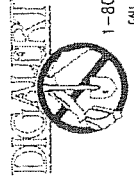
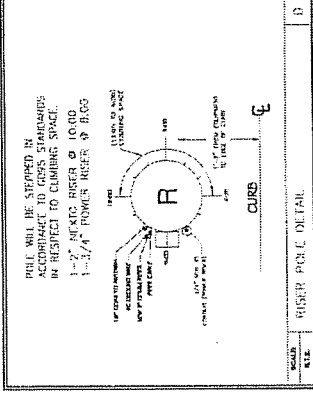
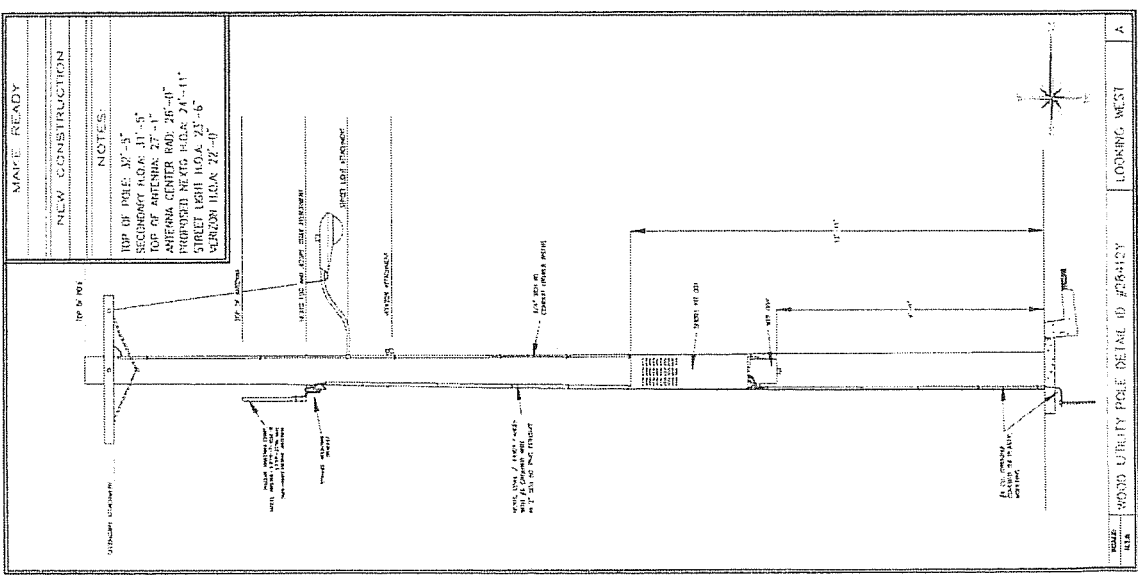
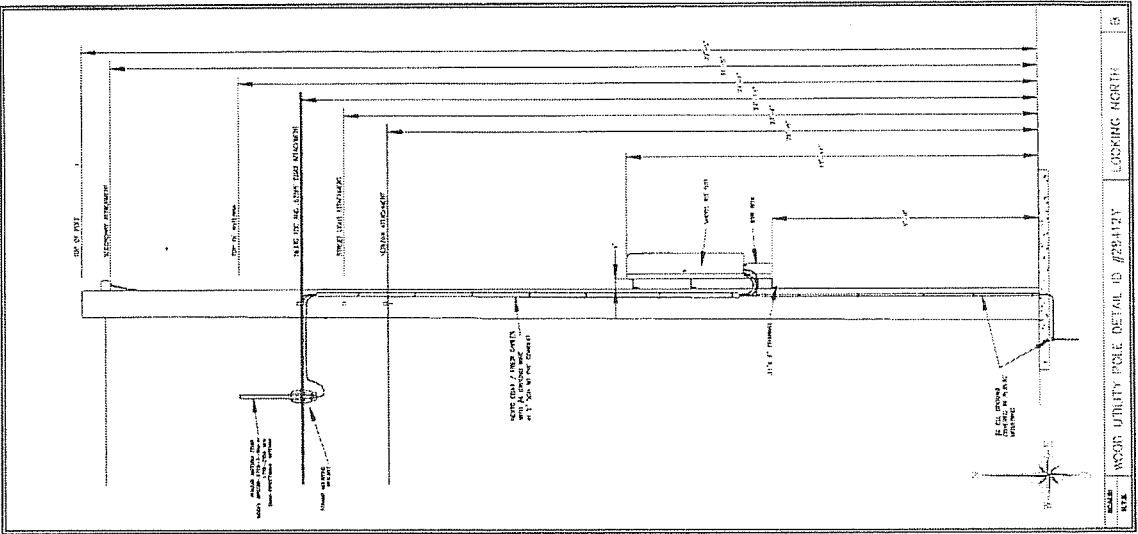

FIG. 1 SITE POLE PICTURE



1-800-227-2500
 CALL AT LEAST TWO DAYS BEFORE YOU GO!

FOR MORE INFORMATION CONTACT SBC TELECOM



MAKE-READY
 NEW CONSTRUCTION

- NOTES:
- TOP OF POLE: 37'-5"
 - SECONDARY M.O.A: 31'-5"
 - TOP OF ANTENNA: 27'-1"
 - ANTENNA CENTER HGT: 26'-0"
 - PROPOSED M.O.A: 24'-11"
 - SUBLET HGT: M.O.A: 23'-5"
 - VERTICAL CLEAR: 22'-0"

NextG Networks, Inc.
 2255 BAYVIEW AVENUE
 SUITE 200
 SAN FRANCISCO, CA 94134
 TEL: 415.754.2500
 FAX: 415.754.2501

PROJECT INFORMATION
 PROJECT NUMBER: 03/02/2009
 PROJECT NAME: SHIRRELL WAY
 PROJECT ADDRESS: 1000 SHIRRELL WAY
 CITY: SAN FRANCISCO, CA 94117

DATE PREPARED BY: [Blank]
 DATE APPROVED BY: [Blank]

HP COMMUNICATIONS
 INC.
 1201 WASHINGTON ST. 4TH
 FLOOR
 SAN FRANCISCO, CA 94102
 TEL: 415.754.2500
 FAX: 415.754.2501

NextG Networks, Inc.
 2255 BAYVIEW AVENUE
 SUITE 200
 SAN FRANCISCO, CA 94134
 TEL: 415.754.2500
 FAX: 415.754.2501

DATE: [Blank]
 DRAWN BY: [Blank]
 CHECKED BY: [Blank]

MAP

3 OF 4

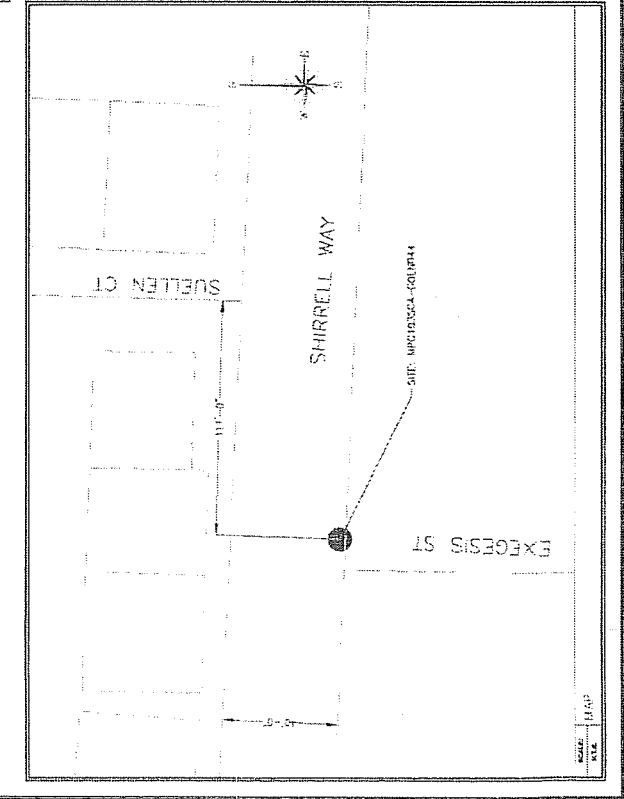
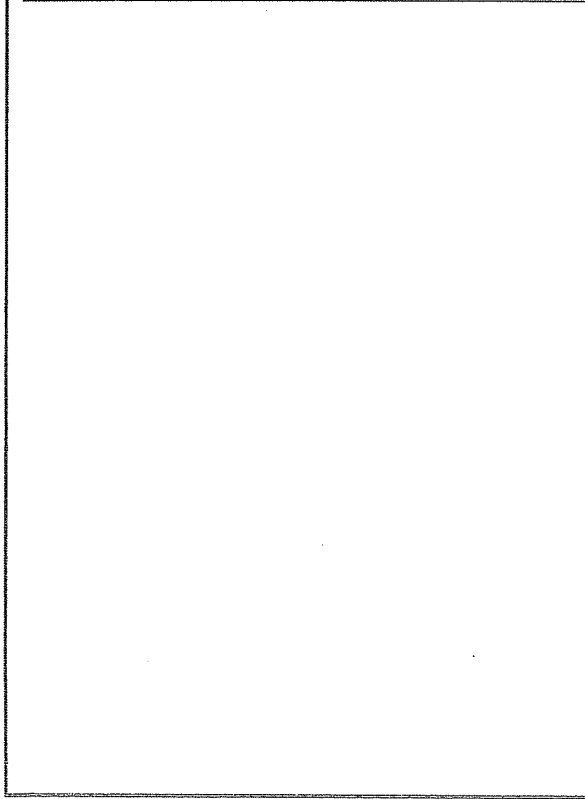
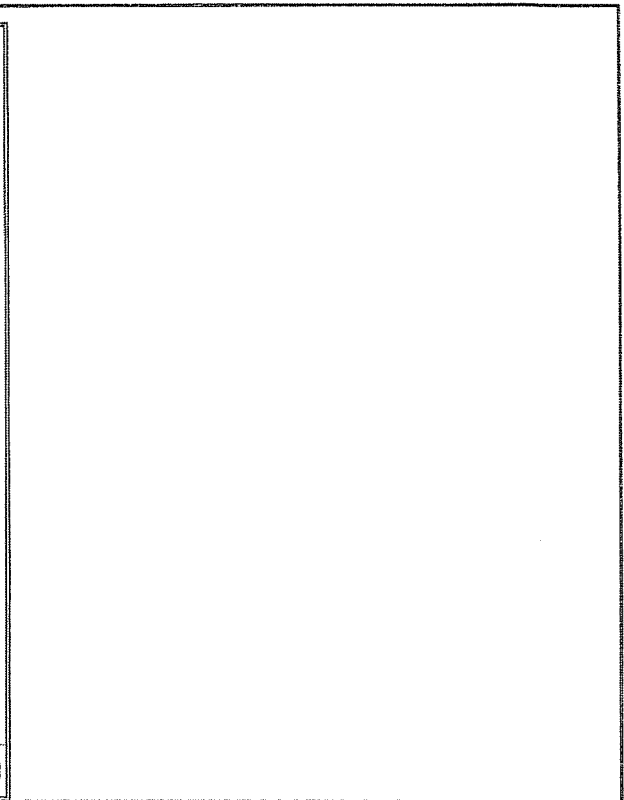
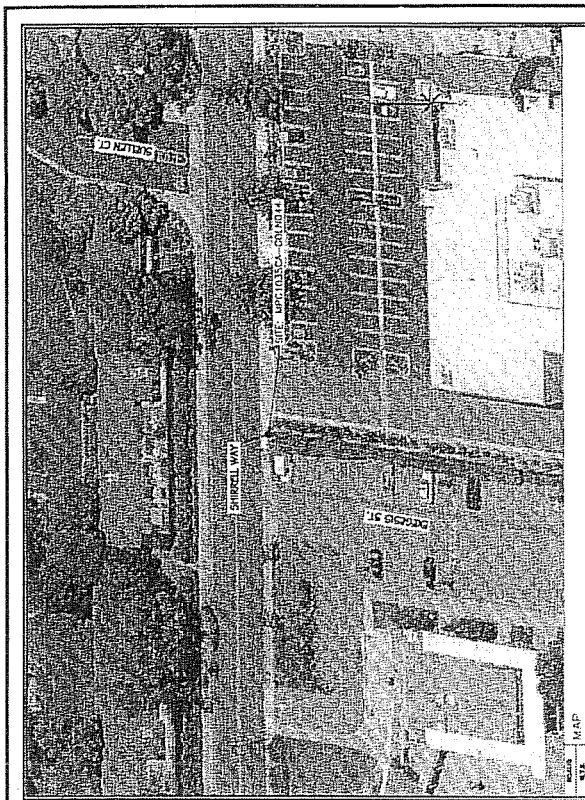

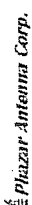

Plazar Antenna Corp.
 170-215 10th Street, San Francisco, CA 94133
 (415) 774-1100
 www.plazar.com

170-215 10th Street, San Francisco, CA 94133
 (415) 774-1100
 www.plazar.com

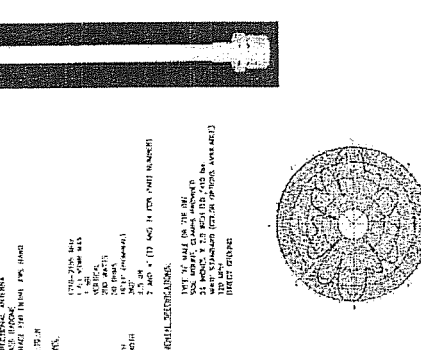
TECHNICAL SPECIFICATIONS
 MODEL: PZ-170-215
 TYPE: 2x2 MIMO
 FREQUENCY RANGE: 1.92 GHz - 2.17 GHz
 BANDWIDTH: 250 MHz
 ANTENNA TYPE: Patch Array
 POLARIZATION: Vertical
 GAIN: 12.5 dBi
 SWR: 1.5
 RADIATION PATTERN: Omnidirectional
 MOUNTING: Pole Mount
 WEIGHT: 1.5 lbs
 DIMENSIONS: 17.0" x 21.5" x 1.5"

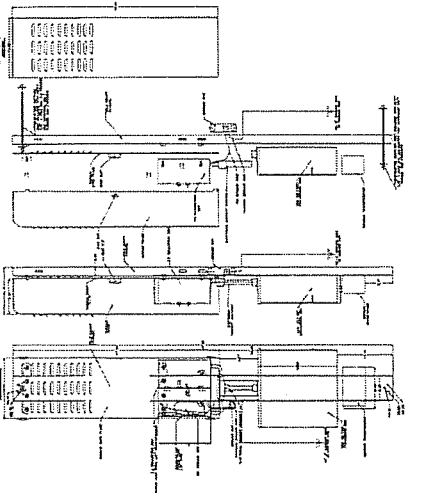

SHRUBS SPECIFICATIONS (SHORT)



SCALE: 1/8" = 1'-0"
 DATE:

REPEATER EQUIPMENT DIMENSIONS

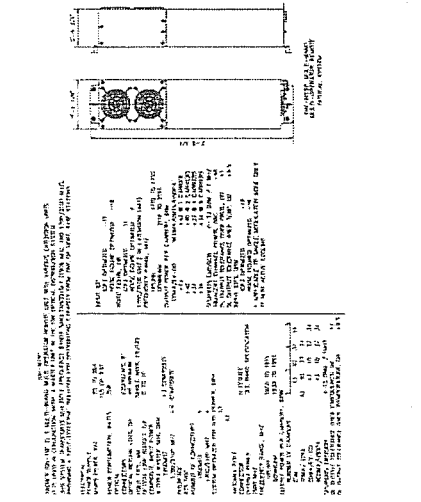

SCALE: 1/8" = 1'-0"
 DATE:

ANTENNA SPECIFICATIONS

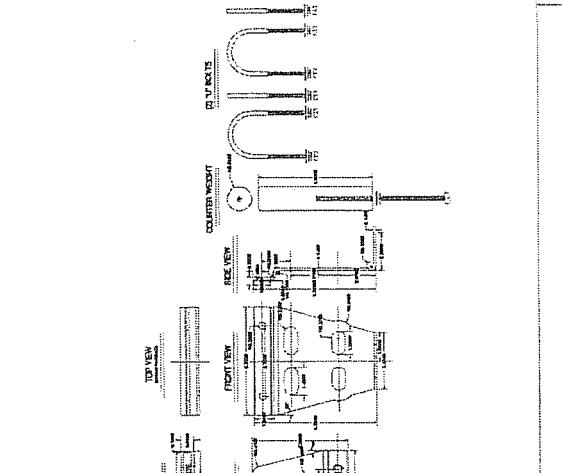

SCALE: 1/8" = 1'-0"
 DATE:

STREAM ANTENNA (SHORT)

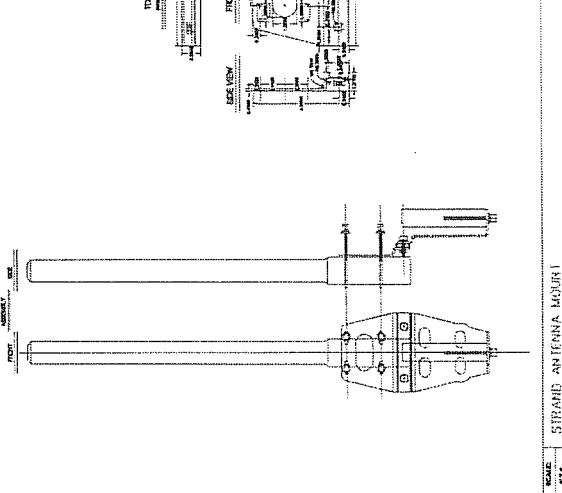

SCALE: 1/8" = 1'-0"
 DATE:

REPEATER EQUIPMENT AND MOUNTING CHASSIS CONFIGURATION

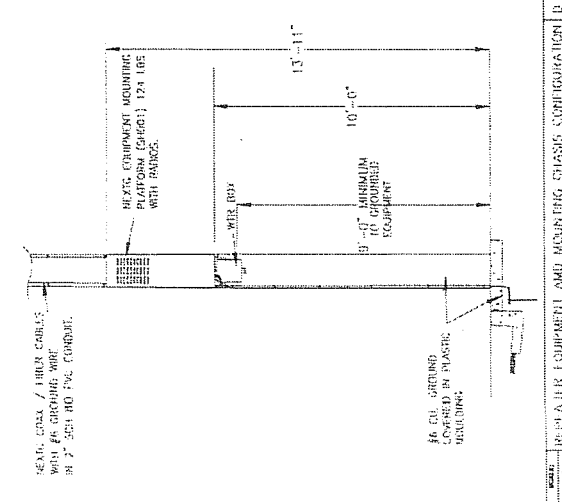

SCALE: 1/8" = 1'-0"
 DATE:

Attachment 2

Antenna Specifications

**1710 – 2155
MHz Omni-
Directional
Antenna**



- Rugged, fiberglass radome
- Frequency coverage for entire AWS band
- Model AWS360-1710-7-T0-N

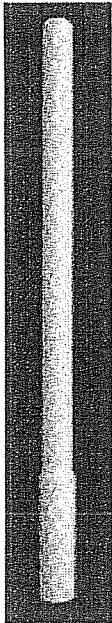

ELECTRICAL SPECIFICATIONS

SPECS	PERFORMANCE
Frequency Range	1710-2155 MHz
VSWR	1.7:1 Max
Forward Gain	7 dBi
Polarization	Vertical
Max Power Input	200 Watts
Input Impedance	50 ohms
Vertical -3dB beamwidth	16 +/- 1 Degree (nominal)
Horizontal -3dB beamwidth	360 degrees
Azimuth Ripple	+/- 0.5 dB
Electrical Downtilt	2 and 4 degrees (T2 and T4 for Part Number)

MECHANICAL SPECIFICATIONS

SPECS	PERFORMANCE
Connector	Type N Female
Mounting	Side mount; clamps provided
Dimension and Weight	26" x 2.0" O.D. / <10 lbs.
Color	White Standard (Color Options Available)
Wind Survival	120 mph.
Lightning Protection	Direct Ground

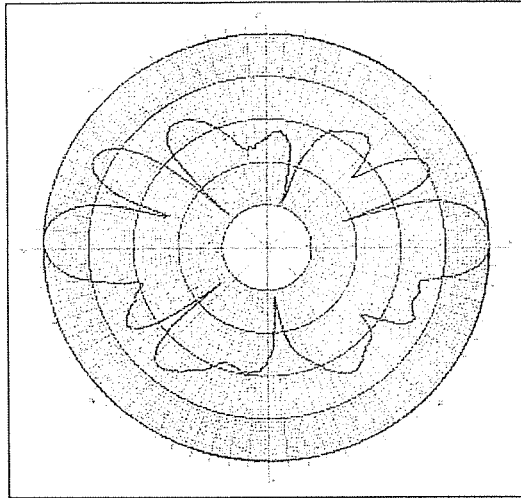

Appendix A-1

RF EXPOSURE AT THE LEVEL OF THE ANTENNA

**RF EXPOSURE AT THE LEVEL OF THE ANTENNA
BASED ON PERCENTAGE OF FCC MAXIMUM PUBLIC EXPOSURE (MPE) LIMIT**

10 feet

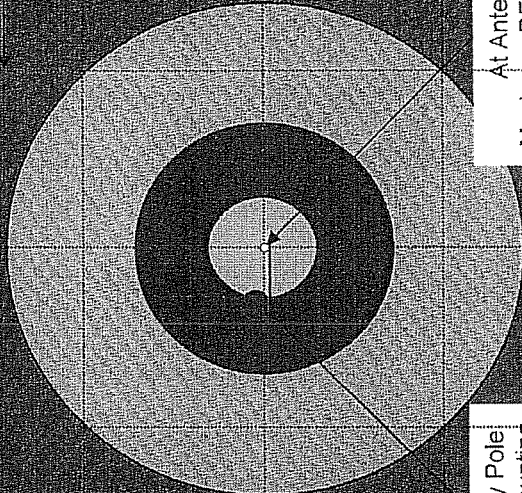

Utility Pole
& Mounting
Bracket

At Antenna
Maximum RF Exposure
<57.2% Public MPE

- Red: Greater than 100% Public MPE
- Yellow: Less than 100% Public MPE
- Blue: Less than 20% Public MPE
- Tan: Less than 5% Public MPE
- Green: Less than 1% Public MPE

Appendix A-2

RF NOTICE SIGN

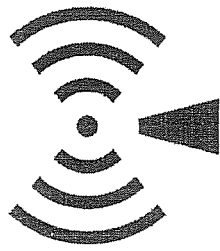

INFORMATION

The radio frequency (RF) emissions at this site have been evaluated for potential RF exposure to personnel who may need to work near these antennae.

RF EXPOSURE AT THIS SITE DOES NOT EXCEED THE FCC PUBLIC EXPOSURE STANDARD AND THUS HAS BEEN DETERMINED TO BE SAFE FOR THE GENERAL POPULATION.

Reference: Federal Communications Commission (FCC) Public Exposure Standard, OET Bulletin-65, Edition 97-01, August 1997.

Appendix A-3

**Phazar Antenna Corp. Antenna model # AWS360-1710-7-T0-N
Exposure Calculation 6.0 ft Above Grade Level (AGL)
Antenna Center 26.0 ft AGL
ERP 48.6 Watts (AWS)**

RF Exposure Levels AGL= 6 feet
Antenna Center 26 feet AGL

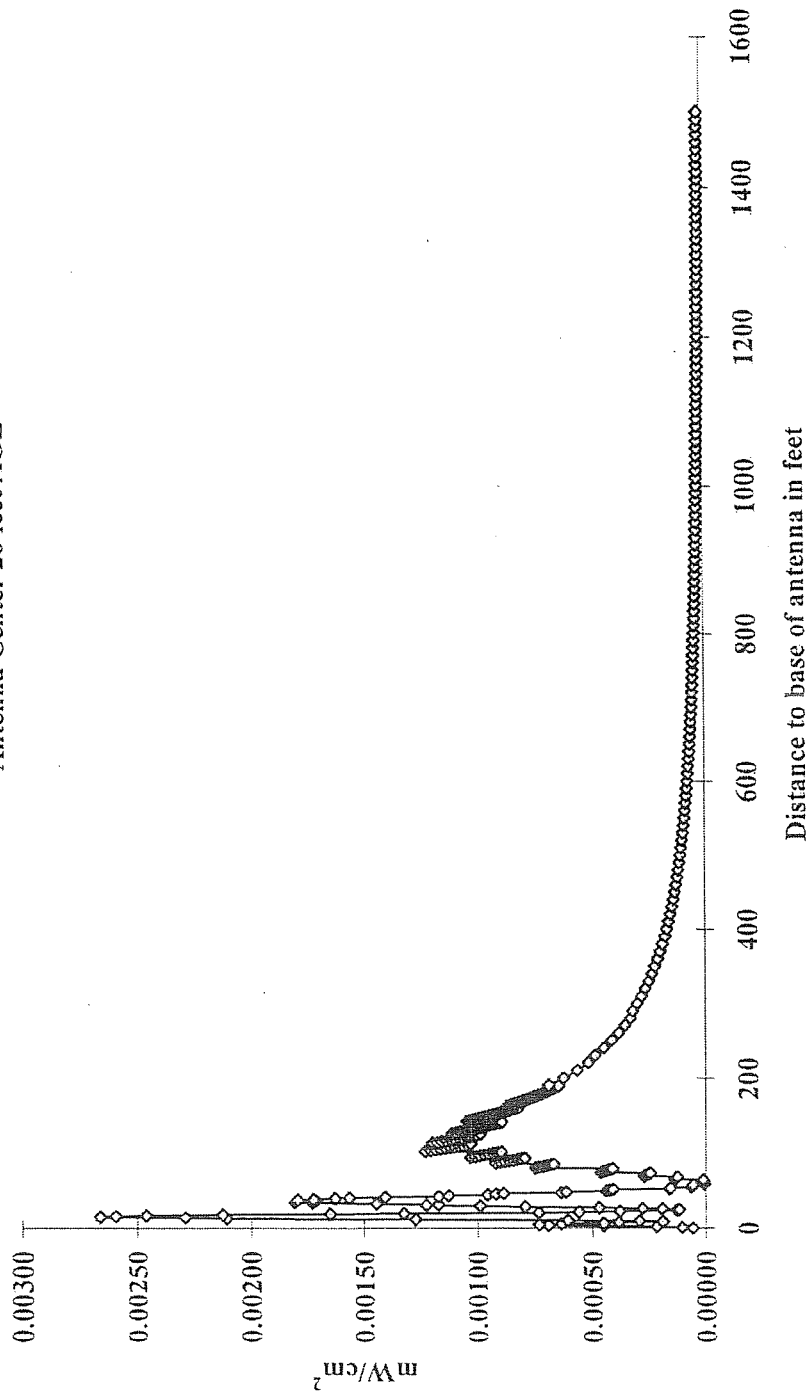

ARL 20 *Max gain* 4.86 *(dBd):*

Max exposure: 0.00266293 *mW/cm²*

Max ERP

(W):

48.6

Ant type: Phazar AWS 360-1710-7-T0-N

Feet from site: 15

RF Exposure Level

<i>Feet to Ant. base</i>	<i>Depress angle</i>	<i>Antenna gain</i>	<i>dB from max ERP</i>	<i>Prop dist in cm</i>	<i>Act ERP in mW</i>	<i>Level mW/cm²</i>	<i>Percent of FCC STD</i>
------------------------------	--------------------------	-------------------------	----------------------------	----------------------------	--------------------------	------------------------------------	-------------------------------

0	90.000	-25.88	-30.74	609.60	40.9861	0.00006	0.00576
1	87.138	-23.2467	-28.10669	610.36	75.1567	0.00011	0.01053
2	84.289	-20.0869	-24.94692	612.64	155.5765	0.00022	0.02164
3	81.469	-16.8628	-21.72277	616.42	326.8582	0.00045	0.04491
4	78.690	-14.9056	-19.76558	621.67	512.9537	0.00069	0.06929
5	75.964	-14.5567	-19.41669	628.36	555.8620	0.00073	0.07349
6	73.301	-15.0779	-19.93791	636.44	492.9983	0.00064	0.06354
7	70.710	-16.4469	-21.30692	645.86	359.7036	0.00045	0.04502
8	68.199	-16.9833	-21.84327	656.56	317.9137	0.00038	0.03850
9	65.772	-19.9026	-24.76264	668.48	162.3202	0.00019	0.01896
10	63.435	-17.8501	-22.71007	681.55	260.3930	0.00029	0.02926
11	61.189	-14.5008	-19.36084	695.72	563.0569	0.00061	0.06073
12	59.036	-11.0898	-15.94978	710.91	1234.9763	0.00128	0.12756
13	56.976	-8.71154	-13.57154	727.06	2135.4139	0.00211	0.21088
14	55.008	-8.1511	-13.0111	744.11	2429.5508	0.00229	0.22906
15	53.130	-7.2906	-12.1506	762.00	2961.9395	0.00266	0.26629
16	51.340	-7.18966	-12.04966	780.67	3031.5889	0.00260	0.25968
17	49.635	-7.21	-12.07	800.06	3017.4235	0.00246	0.24608
18	48.013	-7.62941	-12.48941	820.13	2739.6536	0.00213	0.21263
19	46.469	-8.50976	-13.36976	840.83	2236.9726	0.00165	0.16517
20	45.000	-9.23985	-14.09985	862.10	1890.8261	0.00133	0.13281
21	43.603	-11.586	-16.446	883.92	1101.6302	0.00074	0.07360
22	42.274	-12.5595	-17.41949	906.24	880.4146	0.00056	0.05596
23	41.009	-14.0297	-18.88966	929.02	627.5821	0.00038	0.03796
24	39.806	-18.5393	-23.3993	952.23	222.1809	0.00013	0.01279
25	38.660	-18.7401	-23.60007	975.84	212.1433	0.00012	0.01163
26	37.569	-16.337	-21.197	999.82	368.9235	0.00019	0.01927
27	36.529	-14.5211	-19.38115	1024.15	560.4301	0.00028	0.02789
28	35.538	-12.0418	-16.90177	1048.80	991.8810	0.00047	0.04707
29	34.592	-9.56356	-14.42356	1073.74	1755.0145	0.00079	0.07946
30	33.690	-8.41314	-13.27314	1098.97	2287.2930	0.00099	0.09886
31	32.829	-7.27007	-12.13007	1124.46	2975.9721	0.00123	0.12287
32	32.005	-7.27007	-12.13007	1150.19	2975.9721	0.00117	0.11743
33	31.218	-6.17142	-11.03142	1176.15	3832.6082	0.00145	0.14463
34	30.466	-5.20211	-10.06211	1202.32	4790.9855	0.00173	0.17301
35	29.745	-4.82067	-9.680671	1228.69	5230.8127	0.00181	0.18088

ARL 20 Max gain (dBd): 4.86

Max exposure: 0.00266293 mW/cm²

Max ERP (W):

48.6

Ant type: Phazar AWS 360-1710-7-T0-N

Feet from site: 15

RF Exposure Level

Feet to Ant. base	Depress angle	Antenna gain	dB from max ERP	Prop dist in cm	Act ERP in mW	Level mW/cm ²	Percent of FCC STD
36	29.055	-4.82067	-9.680671	1255.24	5230.8127	0.00173	0.17330
37	28.393	-4.68937	-9.549374	1281.97	5391.3672	0.00171	0.17125
38	27.759	-4.30058	-9.160582	1308.87	5896.2796	0.00180	0.17967
39	27.150	-4.30058	-9.160582	1335.91	5896.2796	0.00172	0.17247
40	26.565	-4.37009	-9.230094	1363.11	5802.6570	0.00163	0.16303
41	26.003	-4.37009	-9.230094	1390.44	5802.6570	0.00157	0.15668
42	25.463	-4.65961	-9.519612	1417.89	5428.4402	0.00141	0.14096
43	24.944	-5.28942	-10.14942	1445.47	4695.6355	0.00117	0.11732
44	24.444	-5.28942	-10.14942	1473.16	4695.6355	0.00113	0.11295
45	23.962	-5.84995	-10.70995	1500.97	4127.0611	0.00096	0.09563
46	23.499	-5.84995	-10.70995	1528.87	4127.0611	0.00092	0.09217
47	23.051	-5.84995	-10.70995	1556.87	4127.0611	0.00089	0.08889
48	22.620	-7.14898	-12.00898	1584.96	3060.1181	0.00064	0.06359
49	22.203	-7.14898	-12.00898	1613.14	3060.1181	0.00061	0.06139
50	21.801	-8.46954	-13.32954	1641.40	2257.7852	0.00044	0.04375
51	21.413	-8.46954	-13.32954	1669.74	2257.7852	0.00042	0.04227
52	21.038	-8.46954	-13.32954	1698.15	2257.7852	0.00041	0.04087
53	20.674	-12.3602	-17.22022	1726.63	921.7530	0.00016	0.01614
54	20.323	-12.3602	-17.22022	1755.18	921.7530	0.00016	0.01562
55	19.983	-16.252	-21.11199	1783.80	376.2163	0.00006	0.00617
56	19.654	-16.252	-21.11199	1812.47	376.2163	0.00006	0.00598
57	19.335	-16.252	-21.11199	1841.20	376.2163	0.00006	0.00579
58	19.026	-16.252	-21.11199	1869.99	376.2163	0.00006	0.00562
59	18.726	-25.4966	-30.35658	1898.83	44.7691	0.00001	0.00065
60	18.435	-25.4966	-30.35658	1927.72	44.7691	0.00001	0.00063
61	18.153	-25.4966	-30.35658	1956.66	44.7691	0.00001	0.00061
62	17.879	-22.4546	-27.3146	1985.65	90.1937	0.00001	0.00119
63	17.613	-22.4546	-27.3146	2014.68	90.1937	0.00001	0.00116
64	17.354	-22.4546	-27.3146	2043.75	90.1937	0.00001	0.00113
65	17.103	-22.4546	-27.3146	2072.86	90.1937	0.00001	0.00110
66	16.858	-11.4187	-16.27874	2102.02	1144.8867	0.00014	0.01353
67	16.621	-11.4187	-16.27874	2131.20	1144.8867	0.00013	0.01316
68	16.390	-11.4187	-16.27874	2160.43	1144.8867	0.00013	0.01280
69	16.164	-11.4187	-16.27874	2189.69	1144.8867	0.00012	0.01247
70	15.945	-7.94152	-12.80152	2218.98	2549.6705	0.00027	0.02703
71	15.732	-7.94152	-12.80152	2248.30	2549.6705	0.00026	0.02633
72	15.524	-7.94152	-12.80152	2277.65	2549.6705	0.00026	0.02566
73	15.322	-7.94152	-12.80152	2307.04	2549.6705	0.00025	0.02501
74	15.124	-7.94152	-12.80152	2336.45	2549.6705	0.00024	0.02438
75	14.931	-5.0511	-9.911097	2365.88	4960.5133	0.00046	0.04626

ARL 20 Max gain (dBd): 4.86 Max exposure: 0.00266293 mW/cm²

Max ERP

(W): 48.6 Ant type: Phazar AWS 360-1710-7-T0-N Feet from site: 15

RF Exposure Level

Feet to Ant. base	Depress angle	Antenna gain	dB from max ERP	Prop dist in cm	Act ERP in mW	Level mW/cm ²	Percent of FCC STD
76	14.744	-5.0511	-9.911097	2395.35	4960.5133	0.00045	0.04513
77	14.560	-5.0511	-9.911097	2424.84	4960.5133	0.00044	0.04404
78	14.381	-5.0511	-9.911097	2454.35	4960.5133	0.00043	0.04299
79	14.207	-5.0511	-9.911097	2483.89	4960.5133	0.00042	0.04197
80	14.036	-5.0511	-9.911097	2513.45	4960.5133	0.00041	0.04099
81	13.870	-2.3328	-7.192795	2543.03	9275.9144	0.00075	0.07488
82	13.707	-2.3328	-7.192795	2572.63	9275.9144	0.00073	0.07316
83	13.548	-2.3328	-7.192795	2602.25	9275.9144	0.00072	0.07151
84	13.392	-2.3328	-7.192795	2631.89	9275.9144	0.00070	0.06991
85	13.241	-2.3328	-7.192795	2661.55	9275.9144	0.00068	0.06836
86	13.092	-2.3328	-7.192795	2691.23	9275.9144	0.00067	0.06686
87	12.947	-0.84236	-5.702363	2720.93	13073.7451	0.00092	0.09218
88	12.804	-0.84236	-5.702363	2750.64	13073.7451	0.00090	0.09020
89	12.665	-0.84236	-5.702363	2780.37	13073.7451	0.00088	0.08829
90	12.529	-0.84236	-5.702363	2810.12	13073.7451	0.00086	0.08643
91	12.395	-0.84236	-5.702363	2839.88	13073.7451	0.00085	0.08462
92	12.265	-0.84236	-5.702363	2869.66	13073.7451	0.00083	0.08288
93	12.137	-0.84236	-5.702363	2899.45	13073.7451	0.00081	0.08118
94	12.011	-0.84236	-5.702363	2929.25	13073.7451	0.00080	0.07954
95	11.889	0.369469	-4.490531	2959.07	17281.5683	0.00103	0.10303
96	11.768	0.369469	-4.490531	2988.91	17281.5683	0.00101	0.10098
97	11.650	0.369469	-4.490531	3018.75	17281.5683	0.00099	0.09900
98	11.535	0.369469	-4.490531	3048.61	17281.5683	0.00097	0.09707
99	11.421	0.369469	-4.490531	3078.48	17281.5683	0.00095	0.09519
100	11.310	0.369469	-4.490531	3108.36	17281.5683	0.00093	0.09337
101	11.201	0.369469	-4.490531	3138.26	17281.5683	0.00092	0.09160
102	11.094	0.369469	-4.490531	3168.16	17281.5683	0.00090	0.08988
103	10.989	1.818394	-3.041606	3198.08	24125.4611	0.00123	0.12314
104	10.886	1.818394	-3.041606	3228.00	24125.4611	0.00121	0.12087
105	10.784	1.818394	-3.041606	3257.94	24125.4611	0.00119	0.11865
106	10.685	1.818394	-3.041606	3287.89	24125.4611	0.00117	0.11650
107	10.587	1.818394	-3.041606	3317.84	24125.4611	0.00114	0.11441
108	10.491	1.818394	-3.041606	3347.81	24125.4611	0.00112	0.11237
109	10.397	1.818394	-3.041606	3377.78	24125.4611	0.00110	0.11038
110	10.305	1.818394	-3.041606	3407.77	24125.4611	0.00108	0.10845
111	10.214	1.818394	-3.041606	3437.76	24125.4611	0.00107	0.10657
112	10.125	1.818394	-3.041606	3467.76	24125.4611	0.00105	0.10473
113	10.037	1.818394	-3.041606	3497.77	24125.4611	0.00103	0.10294
114	9.951	2.558738	-2.301262	3527.79	28609.4900	0.00120	0.12000
115	9.866	2.558738	-2.301262	3557.81	28609.4900	0.00118	0.11799

ARL 20 *Max gain* 4.86 *(dBd):* 0.00266293 *Max exposure:* 0.00266293 *mW/cm²*

Max ERP
(W): 48.6 *Ant type:* Phazar AWS 360-1710-7-T0-N *Feet from site:* 15

RF Exposure Level

<i>Feet to Ant. base</i>	<i>Depress angle</i>	<i>Antenna gain</i>	<i>dB from max ERP</i>	<i>Prop dist in cm</i>	<i>Act ERP in mW</i>	<i>Level mW/cm²</i>	<i>Percent of FCC STD</i>
116	9.782	2.558738	-2.301262	3587.85	28609.4900	0.00116	0.11602
117	9.700	2.558738	-2.301262	3617.89	28609.4900	0.00114	0.11410
118	9.620	2.558738	-2.301262	3647.94	28609.4900	0.00112	0.11223
119	9.540	2.558738	-2.301262	3677.99	28609.4900	0.00110	0.11040
120	9.462	2.558738	-2.301262	3708.05	28609.4900	0.00109	0.10862
121	9.386	2.558738	-2.301262	3738.12	28609.4900	0.00107	0.10688
122	9.310	2.558738	-2.301262	3768.20	28609.4900	0.00105	0.10518
123	9.236	2.558738	-2.301262	3798.28	28609.4900	0.00104	0.10352
124	9.162	2.558738	-2.301262	3828.37	28609.4900	0.00102	0.10190
125	9.090	2.558738	-2.301262	3858.46	28609.4900	0.00100	0.10032
126	9.019	2.558738	-2.301262	3888.56	28609.4900	0.00099	0.09877
127	8.949	3.149905	-1.710095	3918.67	32781.3444	0.00111	0.11144
128	8.881	3.149905	-1.710095	3948.78	32781.3444	0.00110	0.10975
129	8.813	3.149905	-1.710095	3978.90	32781.3444	0.00108	0.10809
130	8.746	3.149905	-1.710095	4009.02	32781.3444	0.00106	0.10647
131	8.680	3.149905	-1.710095	4039.15	32781.3444	0.00105	0.10489
132	8.616	3.149905	-1.710095	4069.28	32781.3444	0.00103	0.10334
133	8.552	3.149905	-1.710095	4099.42	32781.3444	0.00102	0.10183
134	8.489	3.149905	-1.710095	4129.56	32781.3444	0.00100	0.10035
135	8.427	3.149905	-1.710095	4159.71	32781.3444	0.00099	0.09890
136	8.366	3.149905	-1.710095	4189.86	32781.3444	0.00097	0.09748
137	8.306	3.149905	-1.710095	4220.02	32781.3444	0.00096	0.09609
138	8.246	3.149905	-1.710095	4250.18	32781.3444	0.00095	0.09473
139	8.188	3.149905	-1.710095	4280.35	32781.3444	0.00093	0.09340
140	8.130	3.149905	-1.710095	4310.52	32781.3444	0.00092	0.09210
141	8.073	3.149905	-1.710095	4340.70	32781.3444	0.00091	0.09082
142	8.017	3.149905	-1.710095	4370.88	32781.3444	0.00090	0.08957
143	7.962	3.889043	-0.970957	4401.06	38863.3836	0.00105	0.10474
144	7.907	3.889043	-0.970957	4431.25	38863.3836	0.00103	0.10332
145	7.853	3.889043	-0.970957	4461.44	38863.3836	0.00102	0.10193
146	7.800	3.889043	-0.970957	4491.64	38863.3836	0.00101	0.10056
147	7.748	3.889043	-0.970957	4521.84	38863.3836	0.00099	0.09922
148	7.696	3.889043	-0.970957	4552.04	38863.3836	0.00098	0.09791
149	7.645	3.889043	-0.970957	4582.25	38863.3836	0.00097	0.09662
150	7.595	3.889043	-0.970957	4612.46	38863.3836	0.00095	0.09536
151	7.545	3.889043	-0.970957	4642.68	38863.3836	0.00094	0.09412
152	7.496	3.889043	-0.970957	4672.89	38863.3836	0.00093	0.09291
153	7.447	3.889043	-0.970957	4703.11	38863.3836	0.00092	0.09172
154	7.400	3.889043	-0.970957	4733.34	38863.3836	0.00091	0.09055
155	7.352	3.889043	-0.970957	4763.57	38863.3836	0.00089	0.08941

ARL 20 Max gain (dBd): 4.86

Max exposure: 0.00266293 mW/cm²

Max ERP

(W): 48.6 Ant type: Phazar AWS 360-1710-7-T0-N

Feet from site: 15

RF Exposure Level

Feet to Ant. base	Depress angle	Antenna gain	dB from max ERP	Prop dist in cm	Act ERP in mW	Level mW/cm ²	Percent of FCC STD
156	7.306	3.889043	-0.970957	4793.80	38863.3836	0.00088	0.08828
157	7.260	3.889043	-0.970957	4824.03	38863.3836	0.00087	0.08718
158	7.214	3.889043	-0.970957	4854.27	38863.3836	0.00086	0.08610
159	7.169	3.889043	-0.970957	4884.51	38863.3836	0.00085	0.08503
160	7.125	3.889043	-0.970957	4914.75	38863.3836	0.00084	0.08399
161	7.081	3.889043	-0.970957	4945.00	38863.3836	0.00083	0.08297
162	7.038	3.889043	-0.970957	4975.25	38863.3836	0.00082	0.08196
163	6.995	4.219751	-0.640249	5005.50	41938.3492	0.00087	0.08738
164	6.953	4.219751	-0.640249	5035.75	41938.3492	0.00086	0.08633
165	6.911	4.219751	-0.640249	5066.01	41938.3492	0.00085	0.08530
166	6.870	4.219751	-0.640249	5096.27	41938.3492	0.00084	0.08429
167	6.829	4.219751	-0.640249	5126.53	41938.3492	0.00083	0.08330
168	6.789	4.219751	-0.640249	5156.80	41938.3492	0.00082	0.08233
169	6.749	4.219751	-0.640249	5187.07	41938.3492	0.00081	0.08137
170	6.710	4.219751	-0.640249	5217.34	41938.3492	0.00080	0.08043
171	6.671	4.219751	-0.640249	5247.61	41938.3492	0.00080	0.07950
172	6.633	4.219751	-0.640249	5277.88	41938.3492	0.00079	0.07859
173	6.595	4.219751	-0.640249	5308.16	41938.3492	0.00078	0.07770
174	6.557	4.219751	-0.640249	5338.44	41938.3492	0.00077	0.07682
175	6.520	4.219751	-0.640249	5368.72	41938.3492	0.00076	0.07596
176	6.483	4.219751	-0.640249	5399.01	41938.3492	0.00075	0.07511
177	6.447	4.219751	-0.640249	5429.29	41938.3492	0.00074	0.07427
178	6.411	4.219751	-0.640249	5459.58	41938.3492	0.00073	0.07345
179	6.375	4.219751	-0.640249	5489.87	41938.3492	0.00073	0.07264
180	6.340	4.219751	-0.640249	5520.16	41938.3492	0.00072	0.07185
181	6.305	4.219751	-0.640249	5550.46	41938.3492	0.00071	0.07106
182	6.271	4.219751	-0.640249	5580.75	41938.3492	0.00070	0.07029
183	6.237	4.219751	-0.640249	5611.05	41938.3492	0.00070	0.06954
184	6.203	4.219751	-0.640249	5641.35	41938.3492	0.00069	0.06879
185	6.170	4.219751	-0.640249	5671.66	41938.3492	0.00068	0.06806
186	6.137	4.219751	-0.640249	5701.96	41938.3492	0.00067	0.06734
187	6.105	4.219751	-0.640249	5732.27	41938.3492	0.00067	0.06663
188	6.072	4.219751	-0.640249	5762.57	41938.3492	0.00066	0.06593
189	6.041	4.219751	-0.640249	5792.88	41938.3492	0.00065	0.06524
190	6.009	4.219751	-0.640249	5823.20	41938.3492	0.00065	0.06456
191	5.978	4.559852	-0.300148	5853.51	45354.6122	0.00069	0.06910
201	5.682	4.559852	-0.300148	6156.73	45354.6122	0.00062	0.06246
211	5.415	4.559852	-0.300148	6460.11	45354.6122	0.00057	0.05673
221	5.171	4.559852	-0.300148	6763.61	45354.6122	0.00052	0.05176
231	4.948	4.679971	-0.180029	7067.22	46626.5588	0.00049	0.04873

ARL 20 *Max gain (dBd):* 4.86

Max exposure: 0.00266293 *mW/cm²*

Max ERP

(W): 48.6 *Ant type:* Phazar AWS 360-1710-7-T0-N

Feet from site: 15

RF Exposure Level

<i>Feet to Ant. base</i>	<i>Depress angle</i>	<i>Antenna gain</i>	<i>dB from max ERP</i>	<i>Prop dist in cm</i>	<i>Act ERP in mW</i>	<i>Level mW/cm²</i>	<i>Percent of FCC STD</i>
241	4.744	4.679971	-0.180029	7370.93	46626.5588	0.00045	0.04480
251	4.556	4.679971	-0.180029	7674.73	46626.5588	0.00041	0.04132
261	4.382	4.679971	-0.180029	7978.60	46626.5588	0.00038	0.03824
271	4.221	4.679971	-0.180029	8282.54	46626.5588	0.00035	0.03548
281	4.071	4.679971	-0.180029	8586.55	46626.5588	0.00033	0.03301
291	3.932	4.849938	-0.010062	8890.60	48487.5323	0.00032	0.03202
301	3.801	4.849938	-0.010062	9194.71	48487.5323	0.00030	0.02994
311	3.680	4.849938	-0.010062	9498.86	48487.5323	0.00028	0.02805
321	3.565	4.849938	-0.010062	9803.05	48487.5323	0.00026	0.02634
331	3.458	4.849938	-0.010062	10107.28	48487.5323	0.00025	0.02478
341	3.357	4.849938	-0.010062	10411.54	48487.5323	0.00023	0.02335
351	3.261	4.849938	-0.010062	10715.83	48487.5323	0.00022	0.02204
361	3.171	4.849938	-0.010062	11020.15	48487.5323	0.00021	0.02084
371	3.086	4.849938	-0.010062	11324.50	48487.5323	0.00020	0.01974
381	3.005	4.849938	-0.010062	11628.87	48487.5323	0.00019	0.01872
391	2.928	4.810153	-0.049847	11933.26	48045.3723	0.00018	0.01761
401	2.855	4.810153	-0.049847	12237.67	48045.3723	0.00017	0.01675
411	2.786	4.810153	-0.049847	12542.10	48045.3723	0.00016	0.01594
421	2.720	4.810153	-0.049847	12846.55	48045.3723	0.00015	0.01520
431	2.657	4.810153	-0.049847	13151.02	48045.3723	0.00015	0.01450
441	2.597	4.810153	-0.049847	13455.50	48045.3723	0.00014	0.01385
451	2.539	4.810153	-0.049847	13759.99	48045.3723	0.00013	0.01325
461	2.484	4.810153	-0.049847	14064.50	48045.3723	0.00013	0.01268
471	2.431	4.810153	-0.049847	14369.02	48045.3723	0.00012	0.01215
481	2.381	4.810153	-0.049847	14673.55	48045.3723	0.00012	0.01165
491	2.333	4.810153	-0.049847	14978.09	48045.3723	0.00011	0.01118
501	2.286	4.810153	-0.049847	15282.64	48045.3723	0.00011	0.01074
511	2.241	4.810153	-0.049847	15587.20	48045.3723	0.00010	0.01032
521	2.198	4.810153	-0.049847	15891.78	48045.3723	0.00010	0.00993
531	2.157	4.810153	-0.049847	16196.36	48045.3723	0.00010	0.00956
541	2.117	4.810153	-0.049847	16500.94	48045.3723	0.00009	0.00921
551	2.079	4.810153	-0.049847	16805.54	48045.3723	0.00009	0.00888
561	2.042	4.810153	-0.049847	17110.14	48045.3723	0.00009	0.00857
571	2.006	4.810153	-0.049847	17414.75	48045.3723	0.00008	0.00827
581	1.972	4.780013	-0.079987	17719.37	47713.0981	0.00008	0.00793
591	1.938	4.780013	-0.079987	18023.99	47713.0981	0.00008	0.00767
601	1.906	4.780013	-0.079987	18328.62	47713.0981	0.00007	0.00741
611	1.875	4.780013	-0.079987	18633.25	47713.0981	0.00007	0.00717
621	1.845	4.780013	-0.079987	18937.89	47713.0981	0.00007	0.00694
631	1.815	4.780013	-0.079987	19242.54	47713.0981	0.00007	0.00673

ARL 20 *Max gain* 4.86 *(dBd):* *Max exposure:* 0.00266293 *mW/cm²*

Max ERP

(W): 48.6 *Ant type:* Phazar AWS 360-1710-7-T0-N *Feet from site:* 15

RF Exposure Level

<i>Feet to Ant. base</i>	<i>Depress angle</i>	<i>Antenna gain</i>	<i>dB from max ERP</i>	<i>Prop dist in cm</i>	<i>Act ERP in mW</i>	<i>Level mW/cm²</i>	<i>Percent of FCC STD</i>
641	1.787	4.780013	-0.079987	19547.19	47713.0981	0.00007	0.00652
651	1.760	4.780013	-0.079987	19851.84	47713.0981	0.00006	0.00632
661	1.733	4.780013	-0.079987	20156.50	47713.0981	0.00006	0.00613
671	1.707	4.780013	-0.079987	20461.16	47713.0981	0.00006	0.00595
681	1.682	4.780013	-0.079987	20765.83	47713.0981	0.00006	0.00578
691	1.658	4.780013	-0.079987	21070.50	47713.0981	0.00006	0.00561
701	1.634	4.780013	-0.079987	21375.17	47713.0981	0.00005	0.00545
711	1.611	4.780013	-0.079987	21679.85	47713.0981	0.00005	0.00530
721	1.589	4.780013	-0.079987	21984.53	47713.0981	0.00005	0.00515
731	1.567	4.780013	-0.079987	22289.22	47713.0981	0.00005	0.00501
741	1.546	4.780013	-0.079987	22593.91	47713.0981	0.00005	0.00488
751	1.525	4.780013	-0.079987	22898.60	47713.0981	0.00005	0.00475
761	1.505	4.780013	-0.079987	23203.29	47713.0981	0.00005	0.00463
771	1.486	4.780013	-0.079987	23507.99	47713.0981	0.00005	0.00451
781	1.467	4.780013	-0.079987	23812.68	47713.0981	0.00004	0.00439
791	1.448	4.780013	-0.079987	24117.39	47713.0981	0.00004	0.00428
801	1.430	4.780013	-0.079987	24422.09	47713.0981	0.00004	0.00418
811	1.413	4.780013	-0.079987	24726.80	47713.0981	0.00004	0.00407
821	1.395	4.780013	-0.079987	25031.50	47713.0981	0.00004	0.00398
831	1.379	4.780013	-0.079987	25336.21	47713.0981	0.00004	0.00388
841	1.362	4.780013	-0.079987	25640.93	47713.0981	0.00004	0.00379
851	1.346	4.780013	-0.079987	25945.64	47713.0981	0.00004	0.00370
861	1.331	4.780013	-0.079987	26250.36	47713.0981	0.00004	0.00361
871	1.315	4.780013	-0.079987	26555.08	47713.0981	0.00004	0.00353
881	1.300	4.780013	-0.079987	26859.80	47713.0981	0.00003	0.00345
891	1.286	4.780013	-0.079987	27164.52	47713.0981	0.00003	0.00338
901	1.272	4.780013	-0.079987	27469.24	47713.0981	0.00003	0.00330
911	1.258	4.780013	-0.079987	27773.97	47713.0981	0.00003	0.00323
921	1.244	4.780013	-0.079987	28078.70	47713.0981	0.00003	0.00316
931	1.231	4.780013	-0.079987	28383.43	47713.0981	0.00003	0.00309
941	1.218	4.780013	-0.079987	28688.16	47713.0981	0.00003	0.00303
951	1.205	4.780013	-0.079987	28992.89	47713.0981	0.00003	0.00296
961	1.192	4.780013	-0.079987	29297.62	47713.0981	0.00003	0.00290
971	1.180	4.780013	-0.079987	29602.36	47713.0981	0.00003	0.00284
981	1.168	4.780013	-0.079987	29907.09	47713.0981	0.00003	0.00278
991	1.156	4.780013	-0.079987	30211.83	47713.0981	0.00003	0.00273
1001	1.145	4.780013	-0.079987	30516.57	47713.0981	0.00003	0.00267
1011	1.133	4.780013	-0.079987	30821.31	47713.0981	0.00003	0.00262
1021	1.122	4.780013	-0.079987	31126.05	47713.0981	0.00003	0.00257
1031	1.111	4.780013	-0.079987	31430.79	47713.0981	0.00003	0.00252

STATEMENT OF EXPERIENCE

Jerrold Talmadge Bushberg, Ph.D., DABMP, DABSNM
(800) 760-8414 jrbushberg@hampc.com

Dr. Jerrold Bushberg has performed health and safety analysis for RF & ELF transmissions systems since 1978 and is an expert in both health physics and medical physics. The scientific discipline of Health Physics is devoted to radiation protection, which, among other things, involves providing analysis of radiation exposure conditions, biological effects research, regulations and standards as well as recommendations regarding the use and safety of ionizing and non-ionizing radiation. In addition, Dr. Bushberg has extensive experience and lectures on several related topics including medical physics, radiation protection, (ionizing and non-ionizing), radiation biology, the science of risk assessment and effective risk communication in the public sector.

Dr. Bushberg's doctoral dissertation at Purdue University was on various aspects of the biological effects of microwave radiation. He has maintained a strong professional involvement in this subject and has served as consultant or appeared as an expert witness on this subject to a wide variety of organizations/institutions including, local governments, school districts, city planning departments, telecommunications companies, the California Public Utilities Commission, national news organizations, and the U.S. Congress. In addition, his consultation services have included detailed computer based modeling of RF exposures as well as on-site safety inspections and RF & ELF environmental field measurements of numerous transmission facilities in order to determine their compliance with FCC and other safety regulations. The consultation services provided by Dr. Bushberg are based on his professional judgement as an independent scientist, however they are not intended to necessarily represent the views of any other organization.

Dr. Bushberg is a member of the main scientific body of International Committee on Electromagnetic Safety (ICES) which reviews and evaluates the scientific literature on the biological effects of non-ionizing electromagnetic radiation and establishes exposure standards. He also serves on the ICES Risk Assessment Working Group that is responsible for evaluating and characterizing the risks of non-ionizing electromagnetic radiation. Dr. Bushberg was appointed and is serving as a member of the main scientific council of the National Council on Radiation Protection and Measurement's (NCRP). He is also a Scientific Vice-President of the NCRP, a member of the NCRP Board of Directors and chairs its committee on Radiation Protection in Medicine. In addition, Dr. Bushberg is a member of NCRP's scientific advisory committee on Non-ionizing Radiation Safety. The NCRP is the nation's preeminent scientific radiation protection organization, chartered by Congress to evaluate and provide expert consultation on a wide variety of radiological health issues. The current FCC RF exposure safety standards are based in large part on the recommendations of the NCRP. Dr. Bushberg was elected to the International Engineering in Medicine and Biology Society Committee on Man and Radiation (COMAR) which has as its primary area of responsibility the examination and interpreting the biological effects of non-ionizing electromagnetic energy and presenting its findings in an authoritative and professional manner. Dr. Bushberg is also a member of a six person U.S. expert delegation to the international scientific community on Scientific and Technical Issues for Mobile Communication Systems established by the Federal Communications Commission.

Dr. Bushberg is a full member of the Bioelectromagnetics Society, the Health Physics Society and the Radiation Research Society. Dr. Bushberg received both a Masters of Science and Ph.D. from the Department of Bionucleonics at Purdue University. Dr. Bushberg is certified by several national professional boards with specific sub-specialty certification in radiation protection and medical physics. Prior to coming to California, Dr. Bushberg was on the faculty of Yale University School of Medicine.