

RECORDING REQUESTED BY AND
WHEN RECORDED MAIL TO:

Santa Barbara County
Real Property Division
Will Call

Exempt from the \$75 Building and Jobs Act Fee per Gov't Code §27388.1(2)(D) Public Agency
No fee pursuant to Government Code § 6103
No Documentary Transfer Tax per R&T Code § 11922
No Recording Fee per Government Code § 27383

423 Chapala Street
Santa Barbara, CA 93101
APN: 037-203-025

EASEMENT DEED
(for Flood Control Purposes)

For consideration, THE SALVATION ARMY, A CALIFORNIA CORPORATION ("Grantor), does hereby grant to the SANTA BARBARA COUNTY FLOOD CONTROL AND WATER CONSERVATION DISTRICT ("District"), its successors or assigns, as District herein,

Flood Control Easement:

A permanent easement and right of way in the City of Santa Barbara, County of Santa Barbara, State of California, for all purposes relating to surveys, inspections, excavations, construction, operations, maintenance, repair, removal, replacement and reconstruction of surface and subsurface improvements required for creek flow, flood control and all appurtenant facilities associated with Mission Creek and nearby creek flood control improvements located in the block between the intersection of Haley Street and De La Vina Street and Gutierrez Street, including the unrestricted right of ingress and egress at all times, and any required removal at any time of trees and vegetation, improvements, materials, and any other topographical features that may exist within said easement, being more particularly described as "T1" in Exhibit "A" and depicted as same in Exhibit "B", each attached hereto and incorporated herein by this reference (the "Flood Control Easement").

Together with:

A Temporary Construction Easement for the purposes of facilitating the construction of the flood control improvements and all appurtenant facilities, including the right of ingress and egress for personnel, vehicles, and equipment, and the right to temporarily maintain such vehicles, materials and equipment within said Temporary Construction Easement area, and the right to clear and remove trees and vegetation as necessary to complete the Mission Creek flood control improvement project (Reach 4), and utilize said Temporary Construction Easement for all other related activities and purposes associated with facilitating and accomplishing the construction of the public improvements within and along Mission Creek. This Temporary Construction Easement shall be comprised of two sections, described as follows:

Temporary Exclusive Construction Easement (TCE 1):

A Temporary Exclusive Construction Easement in, on, over, under, through, along and across that certain parcel of land identified and described as "TCE1" in Exhibit "C" and depicted in Exhibit "D", attached hereto and incorporated herein. The Temporary Exclusive Construction Easement area will be fenced by District and access and use of said area will be restricted only for District's use during the term of this easement. District shall have the right to utilize said area for all construction staging needs and purposes related to facilitating the construction of the adjacent flood control and creek improvements, including the right to temporarily store vehicles, equipment, and materials in conjunction with such construction.

Temporary Non-Exclusive Access Easement (TAE 1):

A Temporary Easement for non-exclusive ingress-egress use, for construction personnel, vehicles and equipment to gain access to and from Mission Creek by utilizing Grantor's driveway running along and across that specific portion of Grantor's property described as "TAE1" in Exhibit "E" and depicted as same in Exhibit "F", each attached hereto and incorporated herein. The temporary ingress-egress rights conveyed herein include the right to access through and across Grantor's gated driveway and traverse Grantor's property along the route identified as TAE1 in conjunction with exercising the temporary rights herein granted.

These Temporary Construction Easements shall commence thirty (30) days following the date of issuance of a Notice of Construction Commencement issued by District to Grantor via U.S. Mail, and shall terminate one year after commencement, or upon completion of construction, whichever occurs first; however, District shall have the right to extend the Temporary Construction Easement term in additional three (3) month increments if District determines that additional time beyond the one year period is necessary for construction completion. In such case, District shall have the unilateral right to extend the Temporary Construction Easement period through construction completion and agrees to compensate Grantor Thirteen Thousand Six Hundred Thirty and 75/100 Dollars (\$13,630.75) for each three month extension term exercised. Payment for any such extensions shall be paid by District to Grantor concurrent with District's written notice to Grantor of District's intention to exercise such extension provisions. In any event, this Temporary Construction Easement shall not extend longer than two calendar years from commencement and shall terminate on or before June 30, 2025.

Upon completion of District's project construction, the Temporary Construction Easement areas shall be generally restored to a comparable condition as that which existed prior to District's access and use, to the extent reasonably practical. Grantor acknowledges that any mature trees removed will be replaced with small young trees.

GRANTOR:

THE SALVATION ARMY, A CALIFORNIA CORPORATION

By: _____

Name: **Kelly E. Igleheart**
Title: **VICE PRESIDENT**

By: _____

Name: **David Bentley**
Title: **Asst. Secretary**

ACKNOWLEDGMENT

A notary public or other officer completing this certificate verifies only the identity of the individual who signed the document to which this certificate is attached, and not the truthfulness, accuracy, or validity of that document.

State of California
County of Los Angeles

On May 9, 2022 before me, Jessica Kristina Corona, Notary Public, personally appeared Kelly Iapenbart, who proved to me on the basis of satisfactory evidence to be the person(s) whose name(s) is are subscribed to the within instrument and acknowledged to me that he/she/they executed the same in his/her/their authorized capacity(ies), and that by his/her/their signature(s) on the instrument the person(s), or the entity upon behalf of which the person(s) acted, executed the instrument.

I certify under PENALTY OF PERJURY under the laws of the State of California that the foregoing paragraph is true and correct.

WITNESS my hand and official seal.

Signature [Handwritten Signature] (Seal)



ACKNOWLEDGMENT

A notary public or other officer completing this certificate verifies only the identity of the individual who signed the document to which this certificate is attached, and not the truthfulness, accuracy, or validity of that document.

State of California
County of Los Angeles

On May 9, 2022 before me, Jessica Kristina Corona, Notary Public, personally appeared David Bartlett, who proved to me on the basis of satisfactory evidence to be the person(s) whose name(s) is are subscribed to the within instrument and acknowledged to me that he/she/they executed the same in his/her/their authorized capacity(ies), and that by his/her/their signature(s) on the instrument the person(s), or the entity upon behalf of which the person(s) acted, executed the instrument.

I certify under PENALTY OF PERJURY under the laws of the State of California that the foregoing paragraph is true and correct.

WITNESS my hand and official seal.

Signature [Handwritten Signature] (Seal)



CERTIFICATE OF ACCEPTANCE

STATE OF CALIFORNIA, COUNTY OF SANTA BARBARA: Gov. Code §27281

THIS IS TO CERTIFY that the interest in real property conveyed by the Easement Deed dated as of October 18, 2022, from THE SALVATION ARMY, A CALIFORNIA CORPORATION, as Grantor, to the SANTA BARBARA COUNTY FLOOD CONTROL AND WATER CONSERVATION DISTRICT, a dependent special district of the County of Santa Barbara, its successors or assigns, as Grantee, is hereby accepted by the Director of the Public Works Department on behalf of the Board of Directors of the Santa Barbara County Flood Control and Water Conservation District pursuant to the authority granted by Ordinance #4895, revising Santa Barbara County Code 12A-11.1, adopted on September 2, 2014, and the Grantee consents to recordation thereof by its duly authorized officer.

WITNESS my hand and official seal this 18th day of October, 2022.

MONA MIYASATO
CLERK OF THE BOARD
Ex Officio Clerk of the
Santa Barbara County
Flood Control and Water Conservation District

By Sheila da Guere
Deputy

APPROVED AS TO FORM:
RACHEL VAN MULLEM
COUNTY COUNSEL

By DocuSigned by:
Lauren Wideman
8F464D822C84458...

Deputy County Counsel

EXHIBIT A
T-1

A portion of the parcel of land in Block 251 in the City of Santa Barbara, County of Santa Barbara, State of California, described in Exhibit "B" of the Certificate of Voluntary Merger, recorded August 3, 2001, as Instrument Number 2001-065561, Official Records of said County, described as follows.

Commencing at the northerly corner of said Voluntary Merger;

Course 1 Thence along the northeasterly line of said Voluntary Merger, South 47°34'48" East, 120.53 feet (record per said Voluntary Merger 120.46 feet more or less) to the most easterly corner of said Voluntary Merger;

Course 2 thence, along the southeasterly line of said Voluntary Merger, South 42°25'12" West, 285.00 feet to the TRUE POINT OF BEGINNING;

Course 3 thence, continuing along said southeasterly line, South 42°25'12" West, 15.00 feet to the southerly corner of said Voluntary Merger;

Course 4 thence, along the southwesterly line of said Voluntary Merger, North 47°34'48" West, 43.33 feet;

Course 5 thence, leaving said southwesterly line, North 74°21'40" East, 5.15 feet;

Course 6 thence, South 62°14'59" East, 41.97 feet to the TRUE POINT OF BEGINNING.

The above described parcel of land contains approximately 399 square feet and is as shown on Exhibit B, attached hereto and made a part hereof.

This description has been prepared by me in accordance with provisions of the Professional Land Surveyors Act.

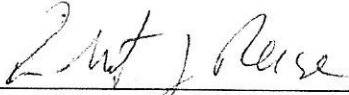

Robert Reese, LS 6208

2022.02.07
date



EXHIBIT B T-1

Haley Street

Chapala Street

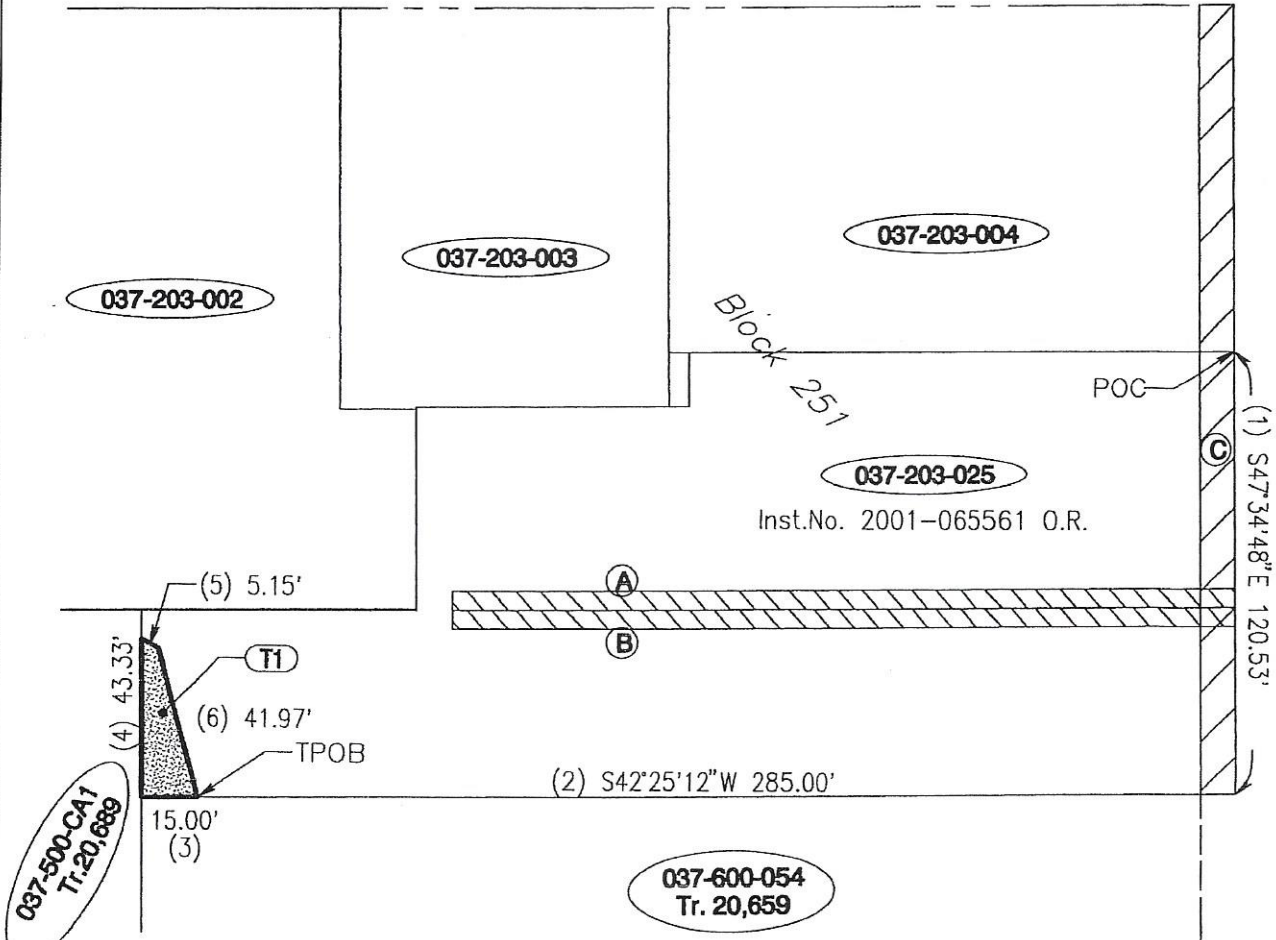

037-203-025
Vesting - Inst.No. 2001-065561 O.R.
A 1007 OR 041 5' driveway easement
B 1007 OR 041 5' driveway easement
C 84 OR 336 10' road easement
T1 399sq.ft. Perm.Easement

This Exhibit has been prepared by me in accordance with provisions of the Professional Land Surveyors Act.



Robert J. Reese

date: 2022.02.07

000-000-000
= Assessor Parcel No.

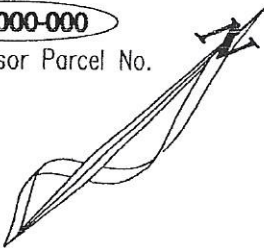

Graphic Scale 1" = 50'
0 50 100

COUNTY OF SANTA BARBARA DEPARTMENT OF PUBLIC WORKS
FLOOD CONTROL DISTRICT

APN 037-203-025

PERMANENT EASEMENT
SANTA BARBARA COUNTY
FLOOD CONTROL DISTRICT
SANTA BARBARA COUNTY, CALIFORNIA

**EXHIBIT C
TCE-1**

A portion of the parcel of land in Block 251 in the City of Santa Barbara, County of Santa Barbara, State of California, described in Exhibit "B" of the Certificate of Voluntary Merger, recorded August 3, 2001, as Instrument Number 2001-065561, Official Records of said County, described as follows.

Commencing at the northerly corner of said Voluntary Merger;

- Course 1 thence along the northeasterly line of said Voluntary Merger, South 47°34'48" East, 120.53 feet (record per said Voluntary Merger 120.46 feet more or less) to the most easterly corner of said Voluntary Merger;
- Course 2 thence, along the southeasterly line of said Voluntary Merger, South 42°25'12" West, 219.00 feet to the TRUE POINT OF BEGINNING;
- Course 3 thence, continuing along said southeasterly line, South 42°25'12" West, 66.00 feet to a point that bears North 42°25'12" East, 15.00 feet from the southerly corner of said Voluntary Merger;
- Course 4 thence, leaving said southeasterly line, North 62°14'59" West, 41.97 feet;
- Course 5 thence, South 74°21'40" West, 5.15 feet to a point on the most southwesterly line of said Voluntary Merger;
- Course 6 thence, along said southwesterly line, North 47°34'48" West, 7.67 feet to the most southwesterly corner of said Voluntary Merger;
- Course 7 thence, leaving said southwesterly line and along a northwesterly line of said Voluntary Merger, North 42°25'12" East, 81.00 feet to a point;
- Course 8 thence, at right angles South 47°34'48" East, 51.00 feet to the TRUE POINT OF BEGINNING.

The above described parcel of land contains approximately 3732 square feet and is as shown on Exhibit D, attached hereto and made a part hereof.

This description has been prepared by me in accordance with provisions of the Professional Land Surveyors Act.

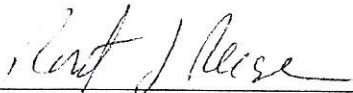

Robert Reese, LS 6208

2022.02.07
date



EXHIBIT D TCE-1

Haley Street

Chapala Street

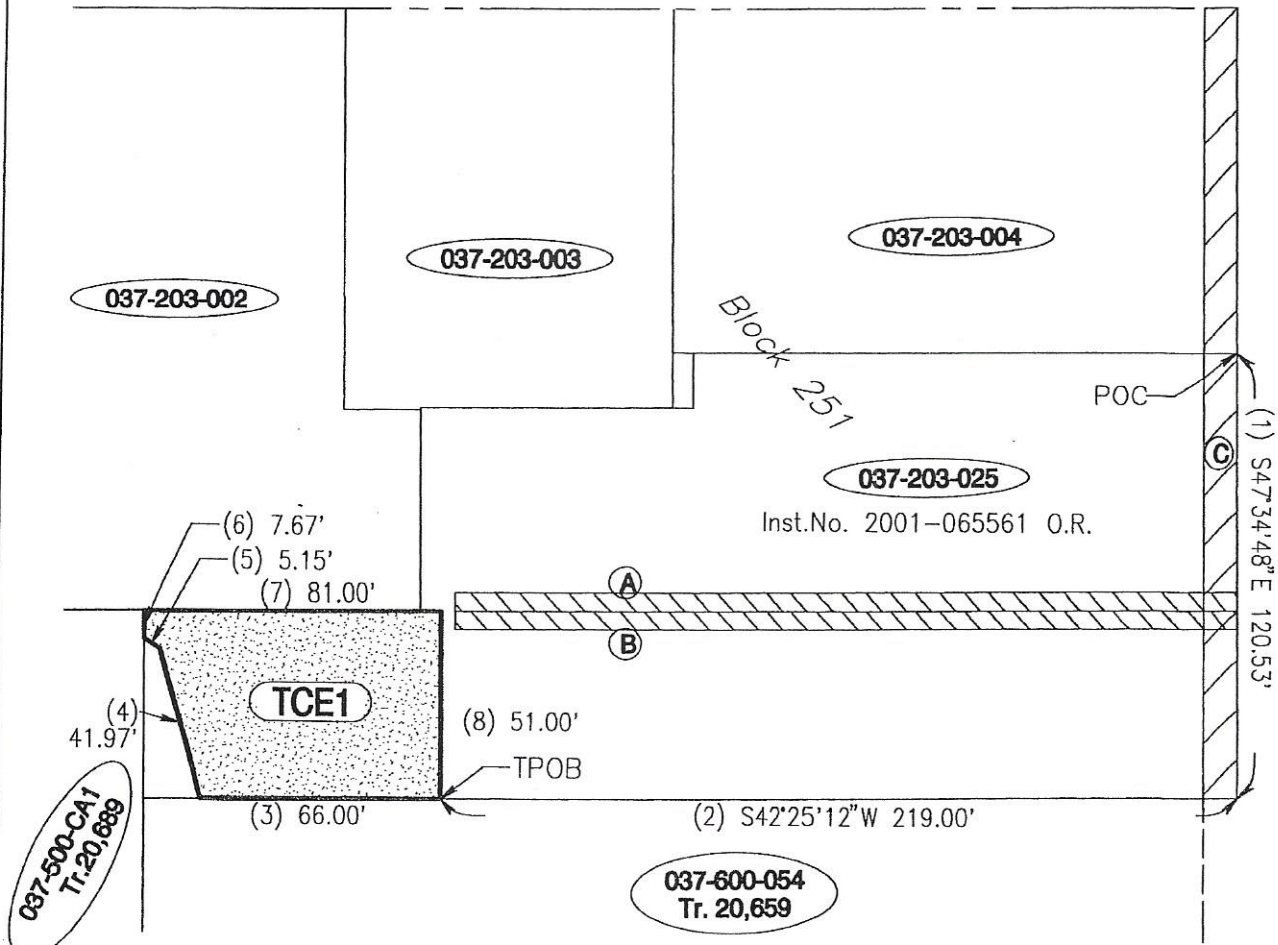

037-203-025
 Vesting - Inst.No. 2001-065561 O.R.
 A 1007 OR 041 5' driveway easement
 B 1007 OR 041 5' driveway easement
 C 84 OR 336 10' road easement

TCE1 3732sq.ft. Temp.Const.Easement

000-000-000
 = Assessor Parcel No.

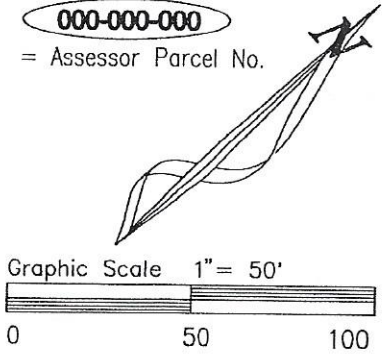

This Exhibit has been prepared by me in accordance with provisions of the Professional Land Surveyors Act.

Robert J. Reese
 date: 2022.02.07



COUNTY OF SANTA BARBARA DEPARTMENT OF PUBLIC WORKS
 FLOOD CONTROL DISTRICT

APN 037-203-025

TEMPORARY CONSTRUCTION EASEMENT
 SANTA BARBARA COUNTY
 FLOOD CONTROL DISTRICT
 SANTA BARBARA COUNTY, CALIFORNIA

EXHIBIT E
TAE-1

A 15.00 feet wide strip of land lying within a parcel of land in Block 251 in the City of Santa Barbara, County of Santa Barbara, State of California, described in Exhibit "B" of the Certificate of Voluntary Merger, recorded August 3, 2001, as Instrument Number 2001-065561, Official Records of said County, described as follows.

Commencing at the northerly corner of said Voluntary Merger;

- Course 1 thence along the northeasterly line of said Voluntary Merger, South 47°34'48" East, 120.53 feet (record per said Voluntary Merger 120.46 feet more or less) to the most easterly corner of said Voluntary Merger;
- Course 2 thence, along the southeasterly line of said Voluntary Merger, South 42°25'12" West, 219.00 feet;
- Course 3 thence, leaving said southeasterly line, at right angles, North 47°34'48" West, 9.80 to the TRUE POINT OF BEGINNING
- Course 4 thence, North 47°34'48" West, 15.00 feet;
- Course 5 thence, parallel with and 24.80 feet northwesterly of said southeasterly line, North 42°25'12" East, 219.00 feet to a point on said northeasterly line;
- Course 6 thence, along said northeasterly line, South 47°34'48" East, 15.00 feet;
- Course 7 thence, leaving said northeasterly line, parallel with and 9.80 feet northwesterly of said southeasterly line, South 42°25'12" West, 219.00 feet to the TRUE POINT OF BEGINNING.

The above described parcel of land contains approximately 3285 square feet and is as shown on Exhibit F, attached hereto and made a part hereof.

This description has been prepared by me in accordance with provisions of the Professional Land Surveyors Act.

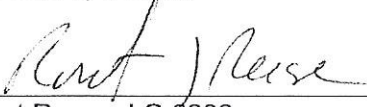

Robert Reese, LS 6208

2022.02.07
date



EXHIBIT F TAE-1

Haley Street

Chapala Street

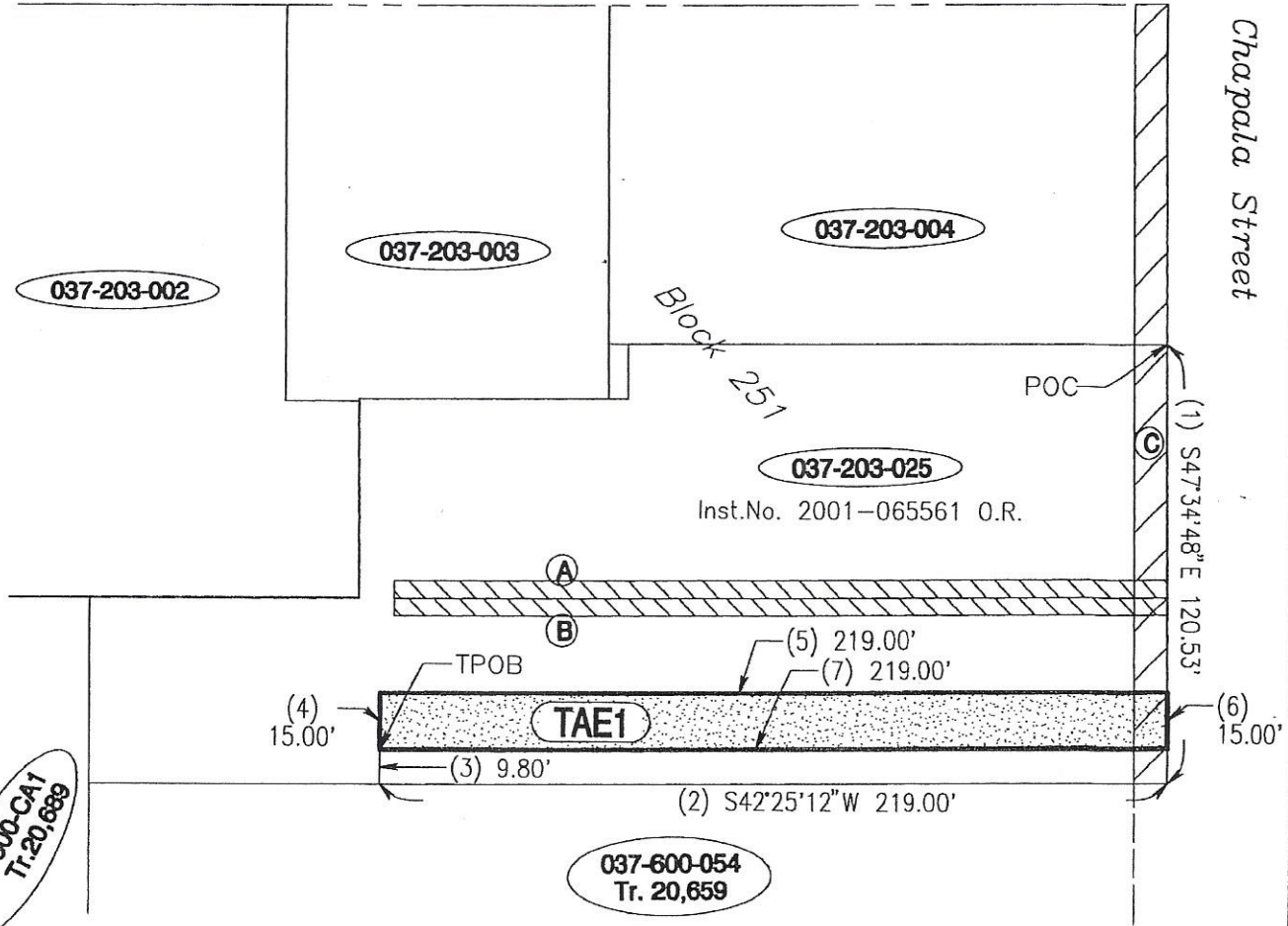

037-203-025
 Vesting - Inst.No. 2001-065561 O.R.
 A 1007 OR 041 5' driveway easement
 B 1007 OR 041 5' driveway easement
 C 84 OR 336 10' road easement

TAE1 3285sq.ft. Temp.AccessEasement

000-000-000
 = Assessor Parcel No.

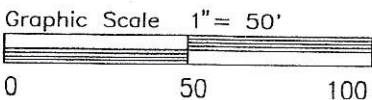
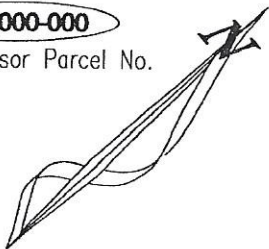

This Exhibit has been prepared by me in accordance with provisions of the Professional Land Surveyors Act.

Robert J. Reese

date: 2022.02.07



COUNTY OF SANTA BARBARA DEPARTMENT OF PUBLIC WORKS
 FLOOD CONTROL DISTRICT

APN 037-203-025

TEMPORARY ACCESS EASEMENT
 SANTA BARBARA COUNTY
 FLOOD CONTROL DISTRICT
 SANTA BARBARA COUNTY, CALIFORNIA