



Countywide Potable Reuse Evaluation

FINAL / October 2023





Countywide Potable Reuse Evaluation

FINAL / October 2023



Contents

EXECUTIVE SUMMARY

ES.1	Background	ES-1
ES.2	Summary of Existing Information	ES-1
ES.3	Regulatory Summary	ES-2
ES.4	Treatment Summary	ES-4
ES.5	Water End Use and Necessary Infrastructure	ES-6
ES.6	Reverse Osmosis Concentrate Disposal	ES-6
ES.7	Planning Level Costs	ES-7
	ES.7.1 Capital Costs	ES-7
	ES.7.2 Operations and Maintenance Costs	ES-8
	ES.7.3 Unit Costs	ES-9
ES.8	Implementation Plan	ES-10

CHAPTER 1 INTRODUCTION

1.1	Background and Purpose	1-1
1.2	Evaluation Study Area and Summary	1-1
1.3	Report Organization	1-2

CHAPTER 2 SUMMARY OF EXISTING INFORMATION

2.1	Introduction	2-1
2.2	Utility Selection Process	2-1
	2.2.1 Basis for Potable Reuse Project Selection	2-1
2.3	Summary of Santa Barbara County Water Supply	2-11
2.4	Select Utility Flow and Water Quality	2-16
	2.4.1 Effluent Water Quality Data	2-16
	2.4.2 Effluent Water Quantity Data	2-23

CHAPTER 3 REGULATORY SUMMARY

3.1	Introduction	3-1
3.2	Regulatory Background and Context	3-1
3.3	Reuse Project Types	3-4
3.4	Potable Reuse Regulatory Summary	3-5
	3.4.1 Project Structure and Interagency Coordination	3-5
	3.4.2 Source Control	3-5
	3.4.3 Feedwater Quality Monitoring	3-6
	3.4.4 Pathogen Control Requirements	3-6
	3.4.5 Wastewater Treatment Requirements	3-7
	3.4.6 Treatment Train Requirements	3-7
	3.4.7 Chemical Control Requirements	3-8
	3.4.8 Additional Monitoring Requirements	3-9
	3.4.9 Groundwater Requirements	3-10

3.4.10	Operational Requirements	3-10
3.4.11	Plans and Reporting	3-11
3.5	Regulation Development and Summary	3-13

CHAPTER 4 TREATMENT SUMMARY

4.1	Introduction	4-1
4.2	Proposed Advanced Water Purification Facility Information	4-1
4.3	Proposed Process Trains	4-1
4.4	Advanced Water Purification Facility Design Criteria	4-2
4.4.1	Ozone and Biologically Enhanced Activated Carbon	4-7
4.4.2	Ultrafiltration	4-8
4.4.3	Reverse Osmosis	4-8
4.4.4	Ultraviolet Disinfection/Advanced Oxidation	4-9
4.4.5	Ultraviolet Disinfection	4-9
4.4.6	Stabilization	4-9
4.4.7	Chlorine Disinfection	4-10
4.4.8	Blending	4-11
4.4.9	Chemicals	4-11
4.5	Advanced Water Purification Facility Layouts	4-11

CHAPTER 5 WATER END USE AND NECESSARY INFRASTRUCTURE

5.1	Introduction	5-1
5.2	End Destination of Purified Recycled Water	5-1
5.2.1	Groundwater Replenishment	5-2
5.2.2	Surface Water Augmentation	5-2
5.2.3	Raw Water Augmentation	5-3
5.2.4	Treated Water Augmentation	5-4
5.3	Solvang and Buellton Advanced Water Purification Facility Infrastructure	5-4
5.3.1	Advanced Water Purification Facility Feedwater Infrastructure	5-4
5.3.2	Flow Equalization	5-6
5.3.3	Advanced Water Purification Facility Finished Water Infrastructure	5-6
5.3.4	Reverse Osmosis Concentrate Infrastructure	5-18
5.3.5	Advanced Water Purification Facility Waste/Backwash Return Infrastructure	5-20
5.4	Summerland Sanitary District Infrastructure	5-20
5.4.1	Existing Carpinteria Sanitary District Collection System	5-21
5.4.2	Summerland Sanitary District Raw Wastewater Piping	5-21
5.4.3	Summerland Sanitary District Flow Equalization	5-26

CHAPTER 6 REVERSE OSMOSIS CONCENTRATE DISPOSAL

6.1	Introduction	6-1
6.2	Reverse Osmosis Concentrate Background and Context	6-1
6.3	Reverse Osmosis Concentrate Disposal Options	6-1
6.3.1	Ocean Outfalls	6-1

6.3.2	Deep Well Injection	6-2
6.4	Reverse Osmosis Concentrate Regulatory Compliance Challenges	6-9
6.4.1	Ocean Outfalls	6-10
6.4.2	Deep Well Injection	6-10
CHAPTER 7 PLANNING LEVEL COSTS		
7.1	Introduction	7-1
7.2	Planning Level Cost Basis	7-1
7.2.1	Cost Estimating Methodology	7-2
7.2.2	Cost Basis	7-5
7.3	Solvang Advanced Water Purification Facility Project Capital and Operations and Maintenance Costs	7-6
7.4	Buellton Advanced Water Purification Facility Project Capital and Operations and Maintenance Costs	7-7
7.5	Solvang/Buellton Combined Advanced Water Purification Facility Project Capital and Operations and Maintenance Costs	7-9
7.6	Summerland Sanitary District Connection to Carpinteria Sanitary District Capital and Operations and Maintenance Costs	7-10
7.6.1	Carpinteria Sanitary District Connection Fees	7-11
7.7	Implementation Timelines	7-11
7.7.1	Indirect Potable Reuse Timeline	7-11
7.7.2	Direct Potable Reuse Timeline	7-13
7.7.3	Summerland Sanitary District Implementation	7-17
7.8	Next Steps	7-18
7.8.1	Solvang and Buellton Next Steps	7-18
7.8.2	Summerland Sanitary District Next Steps	7-19

Appendices

APPENDIX A	WASTEWATER UTILITY QUESTIONNAIRE
APPENDIX B	MONITORING REQUIREMENTS
APPENDIX C	DESIGN CRITERIA SUMMARY
APPENDIX D	GROUNDWATER BASIN ANALYSIS
APPENDIX E	DETAILED COST ESTIMATES

Tables

Table ES.1	Summary Comparison of Key Regulatory Requirements for IPR - GWR (Direct Injection) and DPR - TWA	ES-2
Table ES.2	Summary of Alternative Reuse Treatment Trains in Buellton and Solvang	ES-5
Table ES.3	Treatment Processes for IPR and DPR and Their Role in Meeting the Regulatory Requirements	ES-5
Table ES.4	Solvang and Buellton AWPf Capital Cost Estimates	ES-7

Table ES.5	SSD Capital Cost Estimates	ES-8
Table ES.6	Solvang and Buellton Annual O&M Cost Estimates	ES-9
Table ES.7	SSD Annual O&M Cost Estimates	ES-9
Table ES.8	Solvang and Buellton AWPf Unit Cost Estimates	ES-10
Table 2.1	CSD Planned Project Summary	2-3
Table 2.2	LCSD Planned Project Summary	2-5
Table 2.3	MSD Planned Project Summary	2-7
Table 2.4	City of Santa Barbara DPR Project Summary	2-9
Table 2.5	City of Santa Maria Water Exchange Project Summary	2-9
Table 2.6	County of Santa Barbara Potable Water Supplies	2-12
Table 2.7	Conceptual Review of WWTP Effluent Quality Impacts on Advanced Treatment	2-17
Table 2.8	List of Recorded Constituents From the Effluent Water Quality in Selected Three Utilities	2-19
Table 2.9	City of Solvang Effluent Limitations	2-20
Table 2.10	City of Solvang Water Quality Data	2-20
Table 2.11	City of Buellton Effluent Limitations	2-21
Table 2.12	City of Buellton Water Quality Data	2-22
Table 2.13	Summerland Sanitary District Water Quality Data	2-22
Table 2.14	City of Solvang Influent Flow Summary	2-23
Table 2.15	Minimum Equalization Storage Required for Increased AWPf Treatment Capacity	2-26
Table 2.16	City of Buellton Influent Flow Summary	2-26
Table 2.17	Minimum Required Equalization Storage to CSD Sewer Collection System Under Scenario 1	2-31
Table 2.18	Minimum Required Equalization Storage to CSD Sewer Collection System Under Scenario 2	2-33
Table 3.1	Reuse Pathways Under Consideration for Each Project Location	3-4
Table 3.2	Comparison of Source Control Requirements for IPR - GWR and DPR - TWA	3-5
Table 3.3	Central Coast Basin Median Groundwater Objectives	3-11
Table 3.4	Summary Comparison of Key Regulatory Requirements for IPR - GWR (Direct Injection) and DPR - TWA	3-14
Table 4.1	Summary of Alternative Reuse Treatment Trains in Buellton and Solvang	4-1
Table 4.2	Treatment Processes for IPR and DPR and Their Role in Meeting the Regulatory Requirements	4-3
Table 4.3	Treatment Process Descriptions and Requirements	4-3
Table 4.4	Pathogen LRVs per Process for the IPR Treatment Trains	4-4
Table 4.5	Pathogen LRVs per Process for DPR Treatment Trains	4-5
Table 4.6	Summary of IPR Capacity Criteria for Each Alternative	4-6
Table 4.7	Summary of DPR Capacity Criteria for Each Alternative	4-6
Table 5.1	AWPF Feedwater Pipeline Design Details	5-5
Table 5.2	Flow EQ Basin Design Criteria	5-6
Table 5.3	Estimated Groundwater Travel Times	5-7
Table 5.4	AWPF IPR Finished Water Pipeline Design Details	5-8
Table 5.5	Injection Well Design Criteria	5-11

Table 5.6	SWP Connection Points	5-13
Table 5.7	AWPF DPR Finished Water Pipeline Design Details	5-16
Table 5.8	Blend Tank Design Criteria	5-18
Table 5.9	ROC Deep Well Injection Pipeline Design Details	5-18
Table 5.10	Deep Well Injection Design Criteria	5-19
Table 5.11	AWPF Waste/Backwash Pipeline Design Details	5-20
Table 5.12	Untreated Wastewater Feedwater Design Details	5-21
Table 5.13	Lift Station No. 2 and No. 4 Existing Capacity	5-24
Table 5.14	Lift Station No. 2 and No. 4 Capacity With Added SSD Flows	5-24
Table 5.15	Lift Station No. 2 Capacity Upgrades	5-24
Table 5.16	0.2 mgd Flow Scenario – CSD Pipe Upsizing	5-26
Table 5.17	0.47 mgd Flow Scenario – CSD Pipe Upsizing	5-26
Table 5.18	Flow EQ Basin Design Criteria	5-26
Table 5.19	EQ Basin Odor Control Sizing	5-30
Table 6.1	Summary of RO and ROC	6-1
Table 7.1	Classes of Cost Estimates	7-1
Table 7.2	Indirect Cost Factors Included in Cost Estimates	7-2
Table 7.3	Summary of Project Cost Estimating Methodology	7-2
Table 7.4	AWPF Feed and Finished Water Pipe Material Costs	7-4
Table 7.5	AWPF Feed and Finished Water Pipe Material Costs	7-4
Table 7.6	Raw Wastewater Pipe Material Costs	7-4
Table 7.7	Pump Station Direct Costs	7-5
Table 7.8	Solvang Total Project Cost Estimates	7-6
Table 7.9	Solvang Annual O&M Cost Estimates	7-6
Table 7.10	Solvang Annualized Total Project Cost Estimates	7-7
Table 7.11	Solvang Project Unit Cost Estimates	7-7
Table 7.12	Buellton Total Project Cost Estimates	7-8
Table 7.13	Buellton Annual O&M Cost Estimates	7-8
Table 7.14	Buellton Annualized Total Project Cost Estimates	7-8
Table 7.15	Buellton Project Unit Cost Estimates	7-8
Table 7.16	Solvang/Buellton Combined Total Project Cost Estimates	7-9
Table 7.17	Solvang/Buellton Combined Annual O&M Cost Estimates	7-9
Table 7.18	Solvang/Buellton Combined Annualized Total Project Cost Estimates	7-9
Table 7.19	Solvang/Buellton Combined Project Unit Cost Estimates	7-10
Table 7.20	SSD Total Project Cost Estimates	7-10
Table 7.21	SSD Annual O&M Cost Estimates	7-10
Table 7.22	SSD Annualized Total Project Cost Estimates	7-11

Figures

Figure ES.1	Santa Barbara County Wastewater Utilities	ES-1
Figure ES.2	Potential IPR Implementation Timeline Based on Three Main Project Phases	ES-11
Figure ES.3	Potential DPR Implementation Timeline Based on Four Main Project Phases	ES-12
Figure 1.1	Santa Barbara County Wastewater Utilities	1-2

Figure 2.1	Proportion of Dry Year (2021) Potable Supply for 16 Utilities in Santa Barbara County	2-14
Figure 2.2	Proportion of Wet Year (2019) Potable Supply for 16 Utilities in Santa Barbara County	2-15
Figure 2.3	City of Solvang Average Monthly Flow and Cumulative Monthly Precipitation During 2018 and 2022.	2-24
Figure 2.4	City of Solvang Hourly Diurnal Flow Curve Between May 1, 2022, and May 1, 2023	2-25
Figure 2.5	City of Buellton Average Monthly Flow During 2018 and 2022	2-27
Figure 2.6	City of Buellton Hourly Diurnal Flow Curve Between April 24, 2022, and April 30, 2023	2-27
Figure 2.7	Average Daily Flow in 2018, Outlier Included	2-28
Figure 2.8	Average Daily Flow in 2023, Outliers Included	2-29
Figure 2.9	Summerland Sanitary District Daily Flow Between January 2018 and April 2023, Outliers Removed	2-30
Figure 2.10	Cumulative Storage of Equalization Tank(s) in Summerland Sanitary District for Each Constant Pumping Rate to the CSD Sewer Collection System in 2023	2-32
Figure 2.11	Summerland Sanitary District Hourly Diurnal Flow Curves for Five Wet Weather Days During 2023	2-33
Figure 2.12	Cumulative Storage of Equalization Tank(s) in Summerland Sanitary District for Each Constant Pumping Rate to the CSD Sewer Collection System in One Continuous Week Based Upon the Peak Wet Weather Flow in 2023	2-35
Figure 3.1	Schematic of IPR via GWR	3-1
Figure 3.2	Schematic of IPR via SWA	3-2
Figure 3.3	Schematic of DPR via RWA	3-3
Figure 3.4	Schematic of DPR via TWA	3-3
Figure 4.1	IPR Treatment Trains	4-2
Figure 4.2	DPR Treatment Trains	4-2
Figure 4.3	Available Space for AWPf in Buellton	4-12
Figure 4.4	Available Space for AWPf in Solvang	4-13
Figure 4.5	Buellton IPR AWPf Zoom-Out Site Plan for 0.33-mgd Production	4-13
Figure 4.6	Solvang IPR AWPf Zoom-Out Site Plan for 0.76-mgd Production	4-14
Figure 4.7	IPR AWPf Zoom-Out Site Plan of Buellton and Solvang Combination for 0.78-mgd Production	4-14
Figure 4.8	Buellton DPR AWPf Zoom-Out Site Plan for 0.31-mgd Production	4-15
Figure 4.9	Solvang DPR AWPf Zoom-Out Site Plan for 0.71-mgd Production	4-15
Figure 4.10	Buellton DPR AWPf Zoom-Out Site Plan of Buellton and Solvang Combination for 0.73-mgd Production	4-16
Figure 4.11	Buellton IPR AWPf Zoom-In Site Plan for 0.33-mgd Production	4-16
Figure 4.12	Solvang IPR AWPf Zoom-In Site Plan for 0.76-mgd Production	4-17
Figure 4.13	IPR AWPf Zoom-In Site Plan of Buellton and Solvang Combination for 0.78-mgd Production	4-17
Figure 4.14	Buellton DPR AWPf Zoom-In Site Plan for 0.31-mgd Production	4-18
Figure 4.15	Solvang DPR AWPf Zoom-In Site Plan for 0.71-mgd Production	4-18

Figure 4.16	Buellton DPR AWPf Zoom-In Site Plan of Buellton and Solvang Combination for 0.73-mgd Production	4-19
Figure 5.1	Four IPR/DPR Discharge Options	5-2
Figure 5.2	AWPF Feedwater Preliminary Pipe Alignment: Solvang WWTP to Buellton AWPf Influent	5-5
Figure 5.3	Solvang IPR Preliminary Injection Well Siting	5-9
Figure 5.4	Buellton IPR Preliminary Injection Well Siting	5-10
Figure 5.5	Solvang IPR Injection Well Preliminary Pipe Alignment	5-12
Figure 5.6	Buellton IPR Injection Well Preliminary Pipe Alignment	5-12
Figure 5.7	Combined Solvang/Buellton AWPf IPR Injection Well Preliminary Pipe Alignment	5-13
Figure 5.8	Solvang Water Distribution System	5-14
Figure 5.9	Buellton Water Distribution System	5-15
Figure 5.10	Solvang DPR Finished Water Preliminary Pipe Alignment	5-16
Figure 5.11	Buellton DPR Finished Water Preliminary Pipe Alignment	5-17
Figure 5.12	Combined Solvang/Buellton AWPf DPR Preliminary Pipe Alignment	5-17
Figure 5.13	Solvang ROC Preliminary Pipe Alignment to Deep Well Injection Site	5-19
Figure 5.14	CSD Wastewater Collection System	5-22
Figure 5.15	Untreated Wastewater Feedwater Preliminary Pipe Alignment From SSD to CSD	5-23
Figure 5.16	Modeled Gravity Mains Exceeding $d/D = 0.92$ (0.2 mgd Flow Scenario)	5-25
Figure 5.17	Modeled Gravity Mains Exceeding $d/D = 0.92$ (0.47 mgd Flow Scenario)	5-25
Figure 5.18	Existing (70,000 Gallon) SSD EQ Basin and Supporting Facilities Layout	5-27
Figure 5.19	New (470,000 Gallon) SSD EQ Basin and Supporting Facilities Layout	5-28
Figure 5.20	City of Morro Bay Screenings, Dewatering, and Odor Control System	5-29
Figure 5.21	DCWater Carbon Adsorber Odor Control System	5-30
Figure 6.1	Abandoned Oil and Gas Wells Near Solvang and Buellton	6-2
Figure 6.2	Cross Section Map	6-4
Figure 6.3	Cross Section F - F'	6-4
Figure 6.4	Cross Section G - G'	6-5
Figure 6.5	Formation Legend for Cross Sections	6-5
Figure 6.6	Solvang Potential Injection Areas	6-7
Figure 6.7	Buellton Potential Injection Area	6-8
Figure 7.1	Potential IPR Implementation Timeline Based on Three Main Project Phases	7-12
Figure 7.2	Four Main Phases of DPR Implementation	7-14
Figure 7.3	Potential DPR Implementation Timeline Based on Four Main Project Phases	7-17

Abbreviations

\$	dollar
%	percent
AC	air change
ac-ft	acre-foot
ADWF	average dry-weather flow
AFY	acre-feet per year
AL	action level
AOP	advanced oxidation process
AWPF	Advanced Water Purification Facility
AWT	advanced water treatment
AWTO	Advanced Water Treatment Operator
BAC	biologically enhanced activated carbon
BFT	biotrickling filter tower
BOD ₅	5-day biochemical oxygen demand test
CALGEM	California Geologic Energy Management Division
CAPP	Carpinteria Advanced Purification Project
Carollo	Carollo Engineers
CCR	California Code of Regulations
CEC	Contaminant of Emerging Concern
CEQA	California Environmental Quality Act
cf	cubic feet
cfm	cubic feet per minute
CIP	clean-in-place
CO ₃	carbonate
County	County of Santa Barbara
CPO	Chief Plant Operator
CSD	Carpinteria Sanitary District
CT	contact time
CVWD	Carpinteria Valley Water District
d/D	depth to diameter ratio
DBP	disinfection byproduct
DDW	Division of Drinking Water
DIF	development impact fee
DiPRRA	direct potable reuse responsible agency
DPR	direct potable reuse
EBCT	empty bed contact time
EBRT	empty bed residence time
EC	electrical conductivity

EPA	Environmental Protection Agency
EQ	equalization
Evaluation	Santa Barbara Countywide Potable Reuse Evaluation
GAC	granular activated carbon
gfd	gallons per square foot per day
gpd	gallons per day
gpm	gallons per minute
GRRP	Groundwater Replenishment Reuse Project
GSD	Goleta Sanitary District
GSP	Groundwater Sustainability Plan
GWD	Goleta Water District
GWR	groundwater replenishment
H ₂ S	hydrogen sulfide
HCO ₃	bicarbonate
hp	horsepower
IAP	Independent Advisory Panel
IOGC	Interstate Oil and Gas Company
IPR	indirect potable reuse
LACSD	Los Alamos Community Services District
LCSD	Laguna County Sanitation District
LRV	log removal value
LRWRP	Lompoc Regional Wastewater Reclamation Plant
MBR	membrane bioreactor
MCL	maximum contaminant level
MF	microfiltration
MG	million gallons
mg/L	milligrams per liter
mg/L-N	milligrams per liter of nitrogen
mg-min/L	milligram-minutes per liter
mgd	million gallons per day
MHCSD	Mission Hills Community Services District
mJ/cm ²	millijoules per centimeter squared
mL/L	milliliter per liter
MSD	Montecito Sanitary District
MWD	Montecito Water District
N/A	not applicable
NDMA	N-Nitrosodimethylamine
NL	notification level
NMOR	N-Nitrosomorpholine
NPDES	National Pollutant Discharge Elimination System

NPR	non-potable reuse
NTU	nephelometric turbidity unit
O&G	oil and grease
O&M	operations and maintenance
OOP	Operation Optimization Plan
PDT	pressure decay test
PFAS	per- and poly-fluorinates substances
ppd	pounds per day
PRW	purified recycled water
psi	pounds per square inch
PVC	polyvinyl chloride
PWWF	peak wet weather flow
RO	reverse osmosis
ROC	reverse osmosis concentrate
RWA	raw water augmentation
RWC	recycled municipal wastewater contribution
RWQCB	Regional Water Quality Control Board
SCP	source control program
sMCL	secondary maximum contaminant level
SMVGB	Santa Maria Valley Groundwater Basin
SSD	Summerland Sanitary District
Stipulation	Stipulation Entered in 2008 by the Superior County of the State of California, County of Santa Clara
SWA	surface water augmentation
SWP	State Water Project
SWRCB	State Water Resources Control Board
SYRWCD	Santa Ynez River Water Conservation District
TDS	total dissolved solids
TKN	total Kjeldahl nitrogen
TOC	total organic carbon
TSS	total suspended solids
TWA	treated water augmentation
UF	ultrafiltration
US	United States
UV	ultraviolet
WDR	Waste Discharge Requirement
WRC	water resource center
WRP	water reclamation plant
WTP	water treatment plant
WWTP	wastewater treatment plant

EXECUTIVE SUMMARY

ES.1 Background

The Santa Barbara County Board of Supervisors directed County of Santa Barbara (County) engineering staff to evaluate the potential for potable water reuse using the effluent from the municipal wastewater treatment facilities in the County. This high-level evaluation (Santa Barbara Countywide Potable Reuse Evaluation [Evaluation]) documents and summarizes what each of the wastewater treatment utilities in the County are doing regarding treatment (wastewater and advanced processes) and the end use of that water (water reuse, effluent disposal, including both location and volume). In addition, four potable reuse projects were evaluated within the County, where significant new water can be obtained for potable reuse and/or where current or recent potable reuse studies have not been completed. These four projects considered both indirect potable reuse (IPR) and direct potable reuse (DPR).

ES.2 Summary of Existing Information

As shown on Figure ES.1, 18 wastewater utilities were surveyed to gather high-level information on their respective wastewater systems, existing or planned water reuse programs, and community drinking water supply. The questionnaires were completed by 14 of the 18 utilities and were utilized to compile a comprehensive snapshot of ongoing wastewater treatment, water supply, and planned reuse throughout the County.



Figure ES.1 Santa Barbara County Wastewater Utilities

The data from the questionnaires were reviewed to select four potable reuse projects to evaluate in depth as a part of this study. Utilities who had either already implemented some form of reuse or had recently studied reuse feasibility were eliminated from consideration. Selection criteria for the remaining utilities were utility interest, flow available for reuse, and community water supply needs. The following projects were selected for evaluation:

1. City of Buellton – Individual Advanced Water Purification Facility (AWPF).
2. City of Solvang – Individual AWPF.
3. Buellton-Solvang Joint AWPF (to be sited at the City of Buellton’s Wastewater Treatment Plant [WWTP]).
4. Summerland Sanitary District (SSD) – Raw Wastewater Transfer to Carpinteria Sanitary District (CSD) for Subsequent Planned Carpinteria IPR AWPF.

Chapter 2 details questionnaire findings from all utilities, existing County water supply, and wastewater quality and quantity analysis from the selected utilities (Buellton, Solvang, and SSD). Wastewater quality and quantity analysis is utilized in subsequent chapters for treatment and infrastructure sizing.

ES.3 Regulatory Summary

Purified water can be produced by four major pathways that can have some differences in the way that they are regulated in California. Two of these pathways (groundwater replenishment [GWR] and surface water augmentation [SWA]) are grouped as IPR, while the remaining two pathways (raw water augmentation [RWA] and treated water augmentation [TWA]) are grouped as DPR. The primary form of IPR investigated for this study is GWR and the primary form of DPR investigated for this study is TWA.

Final regulations for GWR have been in place since 2014 and cover two forms of recharge: (1) surface spreading, which entails percolating tertiary effluent through spreading basins, and (2) direct injection, which entails injecting purified water directly into an aquifer. GWR via direct injection was analyzed for the Solvang and Buellton projects. GWR projects are also subject to the requirements of the relevant Groundwater Basin Plans.

DPR regulations for TWA are not yet finalized but are well developed. The draft DPR regulations contain extensive requirements for treatment, monitoring, source control, reporting, and more. The framework remains similar to what has been promulgated for other forms of purified water production. It is anticipated that regulations will be finalized by the end of 2023 and adopted in 2024.

Key regulatory requirements for IPR and DPR projects are summarized below in Table ES.1. Further detail on regulatory requirements can be found in Chapter 3.

Table ES.1 Summary Comparison of Key Regulatory Requirements for IPR - GWR (Direct Injection) and DPR - TWA

Regulatory Requirement	IPR - GWR	DPR - TWA
Project Structure and Interagency Coordination	<ul style="list-style-type: none"> ▪ Main entity is project sponsor. 	<ul style="list-style-type: none"> ▪ DiPRRA is the public water agency responsible for project. ▪ Joint Plan required.

Regulatory Requirement	IPR - GWR	DPR - TWA
Source Control	<ul style="list-style-type: none"> ▪ Requires industrial pretreatment and pollutant SCP including: <ul style="list-style-type: none"> » Assessment of the fate of site-specific chemicals through the wastewater and recycled water treatment systems. » Monitoring and investigation of chemical sources. » Outreach program to minimize discharge of chemicals into the feedwater. 	<ul style="list-style-type: none"> ▪ Requires SCP. ▪ All elements of source control as needed for IPR. ▪ Quantitative evaluation of chemicals discharged to collection system. ▪ Online monitoring that may indicate a chemical peak resulting from an illicit discharge. ▪ Coordination with the pretreatment program for notification of discharges above allowable limits. ▪ Monitoring of local surveillance programs to determine when community outbreaks of disease occur. ▪ Form a source control committee.
Feedwater Monitoring	None.	<ul style="list-style-type: none"> ▪ Prior to operation, 24 months of monthly feedwater monitoring for regulated contaminants (i.e., those with an MCL), priority pollutants, NLs, a specific list of solvents, DBPs, and DBP precursors.
Pathogen Control	<ul style="list-style-type: none"> ▪ 12-log enteric virus. ▪ 10-log <i>Giardia</i>. ▪ 10-log <i>Cryptosporidium</i>. 	<ul style="list-style-type: none"> ▪ 20-log enteric virus. ▪ 14-log <i>Giardia</i>. ▪ 15-log <i>Cryptosporidium</i>.
Treatment Train	<ul style="list-style-type: none"> ▪ RO + UV/AOP required. 	<ul style="list-style-type: none"> ▪ Ozone/BAC + RO + UV/AOP required in this order.
Chemical Control	<ul style="list-style-type: none"> ▪ Maximum recycled water TOC contribution of 0.5 mg/L. ▪ Must meet all current drinking water standards, including MCLs, DBPs, and ALs. Quarterly monitoring. 	<ul style="list-style-type: none"> ▪ Maximum effluent TOC contribution of 0.5 mg/L; additional more stringent TOC thresholds with response actions. ▪ Must meet all current drinking water standards, including MCLs, DBPs, and ALs. Monthly monitoring. ▪ Control of one-hour chemical spike. ▪ Continuous monitoring of nitrate and nitrite in RO permeate.
Additional Monitoring	<ul style="list-style-type: none"> ▪ Quarterly sampling in recycled water and downgradient groundwater wells for priority pollutants, unregulated chemicals, and NLs. 	<ul style="list-style-type: none"> ▪ Monitoring required in feedwater, directly after oxidation process, and finished water for: <ul style="list-style-type: none"> » Monthly: All MCLs, sMCLs, NLs, priority toxic pollutants, ALs, DBPs and DBP precursors, and specified solvents. » Quarterly: Chemicals known to cause cancer or reproductive issues for at least three years. ▪ Weekly monitoring of nitrate, nitrite, perchlorate, and lead in the finished water only.
Environmental Buffer	<ul style="list-style-type: none"> ▪ Minimum aquifer retention time of 2 months. 	<ul style="list-style-type: none"> ▪ No environmental buffer.

Regulatory Requirement	IPR - GWR	DPR - TWA
Response Time	<ul style="list-style-type: none"> Minimum aquifer response retention time of 2 months. 	<ul style="list-style-type: none"> The system must be designed to meet certain response time requirements to ensure that diversion and/or shutoff can occur in the event of a failure to meet the pathogen and/or chemical control requirements. If a failure is identified, the system must divert or shut off before 10 percent of the off-spec water reaches the diversion or shutoff point.
Operations	<ul style="list-style-type: none"> CPO must be a minimum of AWTO Grade 3 and progress to AWTO Grade 5 within two years after project start. Lead shift operator must be a minimum AWTO Grade 3. 	<ul style="list-style-type: none"> Chief operator with T5 and shift operator with T3 certifications required to oversee entire DPR treatment train (may include WWTP, AWPF, and WTP). AWTO Grade 5 required on site at all times, with some exceptions for remote operations allowed. All facility operators must be AWTO certified.
Plans	<ul style="list-style-type: none"> Engineering Report. Operations Optimization Plan. 	<ul style="list-style-type: none"> Joint Plan. Water Safety Plan. Engineering Report. Operations Plan. Pathogen and Chemical Control Point Monitoring and Response. Monitoring Plan. Corrosion Control and Stabilization Plan. Additional Reporting (climate change).
Reporting	<ul style="list-style-type: none"> Annual compliance reporting. 	<ul style="list-style-type: none"> Monthly compliance reporting.

Notes:

AL - action level; AOP - advanced oxidation process; AWTO - Advanced Water Treatment Operator; BAC - biologically enhanced activated carbon; CPO - Chief Plant Operator; DBP - disinfection byproducts; DIPRRA - direct potable reuse responsible agency; MCL - maximum contaminant level; mg/L - milligrams per liter; NL - notification level; RO - reverse osmosis; SCP - source control program; sMCL - secondary maximum contaminant level; TOC - total organic carbon; UV - ultraviolet; WTP - water treatment plant

ES.4 Treatment Summary

To develop the required treatment facility components and sizing needed to produce both IPR- and DPR-quality purified water, this evaluation first looked at the existing effluent quality and quantity of both the Solvang and Buellton WWTPs. A treatment analysis was not performed for the SSD project, as this project involves the transfer of raw wastewater to the CSD for subsequent purification and groundwater recharge with an already planned (and under design) project.

The WWTP effluent water quality is important for this feasibility evaluation for multiple reasons. First, it informs the identification of appropriate treatment technologies and the development of certain design criteria for the proposed treatment train to ensure that all regulatory standards can be met. In addition, it informs the analysis of the reverse osmosis concentrate (ROC) (byproduct generated from RO treatment) disposal.

Use of historical effluent flow data at the Solvang and Buellton WWTPs allows for analysis of equalization (EQ) to maximize the volume of water for reuse. Table ES.2 shows the anticipated feed and finished water flows for the AWWPFs considered in this study.

Table ES.2 Summary of Alternative Reuse Treatment Trains in Buellton and Solvang

City	Reuse Type	Secondary Effluent Flow (mgd)	Finished Water Flow (mgd)
Buellton ⁽¹⁾	Indirect Potable	0.43	0.33
	Direct Potable	0.43	0.31
Solvang	Indirect Potable	1.0 ⁽¹⁾	0.76
	Direct Potable	1.0 ⁽¹⁾	0.71
Buellton + Solvang	Indirect Potable	1.02	0.78
	Direct Potable	1.02	0.73

Notes:

(1) The Solvang AWWPF is sized for 1.0 mgd of equalized flow to capture peak wet weather flows (PWWFs) during storm events. Typical secondary effluent flow is closer to the average dry-weather flow (ADWF) of 0.59 mgd. Anticipated finished water flow at the AWWPF is 0.46 mgd for IPR and 0.43 mgd for DPR. As noted previously, depending on results of ongoing discussions with the Regional Water Quality Control Board (RWQCB), if treatment of all flow is not required the AWWPF may be designed for the lower ADWF flow.
mgd - million gallons per day

The projects must be capable of meeting regulatory standards (either existing IPR regulations or the draft DPR regulations). Table ES.3 shows the key processes in each recommended treatment train.

Table ES.3 Treatment Processes for IPR and DPR and Their Role in Meeting the Regulatory Requirements

Process	Role in Treatment Train	IPR	DPR
Ozone	Provides additional pathogen reduction needed for DPR.		✓
BAC	Provides additional reduction of organics needed for DPR.		✓
UF	Provides pretreatment for RO; also provides pathogen removal for protozoa.	✓	✓
RO	Provides removal of pathogens and chemicals.	✓	✓
UV/AOP	Provides removal of pathogens and chemicals.	✓	✓
Chlorination	Provides additional disinfection of pathogens.	✓	✓
Stabilization (calcite contactors)	Provides remineralization of water post-RO to protect distribution system pipes.	✓	✓
Blending	Provides additional reduction of pathogen and chemical concentrations required for DPR.		✓

Notes:

UF - ultrafiltration

Conceptual treatment site layouts were developed for each treatment system evaluated to understand space required for the AWWPF and supporting facilities. The layouts are single story and include plant feed pump stations, all treatment processes, electrical infrastructure, ancillary equipment, such as chemical storage, and required EQ tanks. Further detail on treatment information and design criteria for the Solvang and Buellton projects can be found in Chapter 4.

ES.5 Water End Use and Necessary Infrastructure

There are several infrastructure components needed to integrate the purified water treatment facility into water delivery systems. The infrastructure components analyzed for the Solvang and Buellton AWPf projects include the following:

- EQ basins for wastewater effluent.
- AWPf feed pipeline and pump station.
- Finished water pump station.
- IPR project infrastructure:
 - » *Finished water injection wells.*
 - » *Finished water pipelines and pump station to connect to injection wells:*
 - Pipelines to two different injection sites were considered, accounting for a 6-month and 12-month groundwater travel time.
- DPR project infrastructure:
 - » *Finished water blend tank.*
 - » *Finished water pipelines and pump station to connect to existing potable water distribution system.*
- ROC disposal pipeline and injection wells.
- Waste/backwash return pipeline.

For the SSD project, infrastructure components are required to utilize the existing WWTP site to effectively equalize and transfer raw wastewater to the CSD collection system. Two equalized flow quantities were considered, 0.2 mgd (to account for the largest EQ basin that can be constructed on the existing site) and 0.47 mgd (to utilize the existing EQ basin). Connection points to the CSD system were determined through flow modeling. Project infrastructure components include the following:

- Infrastructure at the SSD WWTP site:
 - » *EQ basin for raw wastewater (either newly constructed or rehabbed existing).*
 - » *Odor control system.*
 - » *New screenings and screenings dewatering facility.*
- Infrastructure for flow transfer to the CSD collection system:
 - » *Pipeline from WWTP site to CSD collection system.*
 - » *Existing CSD pump station and pipeline upsizing.*

Further detail on the required infrastructure for each project can be found in Chapter 5.

ES.6 Reverse Osmosis Concentrate Disposal

The use of RO in advanced treatment results in the generation of ROC. ROC is a concentrated waste stream that is commonly disposed of using either an ocean outfall or through deep well injection.

The proposed SSD project will transfer raw wastewater to CSD for ultimate advanced treatment through the planned Carpinteria Advanced Purification Project (CAPP). The ROC generated from advanced treatment of the SSD and CSD wastewater will be disposed of through the existing CSD ocean outfall.

Sampling and analysis of water quality is ongoing in support of National Pollutant Discharge Elimination System (NPDES) permit compliance for CAPP.

As the proposed Solvang and Buellton projects are located approximately 10 miles to the nearest coastline, ROC disposal via ocean outfall would require a lengthy and costly pipeline and access to either an existing ocean outfall or construction of a new outfall. For the purposes of this study, deep well injection is the assumed mechanism for ROC disposal for these conceptual projects. Chapter 6 details the underlying geology and identifies preliminary sites for ROC injection wells. The Monterey Formation underlies both cities and is a low permeability layer suitable for deep well injection. For the AWPf sited at the City of Buellton WWTP, the injection wells can likely be sited near the treatment plant. For the AWPf sited at the City of Solvang WWTP, injection wells need to be sited approximately 1.5 miles north of the WWTP for the underlying Monterey Formation to be deep enough to inject.

ES.7 Planning Level Costs

Estimated costs for implementing the projects in this study include costs associated with both infrastructure and treatment. All project costs are detailed in Chapter 7, however, an overall cost summary is provided here for reference.

ES.7.1 Capital Costs

The projects capital costs are divided into two key categories:

- Infrastructure costs.
- Treatment costs.

For the Solvang and Buellton projects, infrastructure costs include the cost to transfer effluent from the WWTP to the new AWPf facility, transfer ROC to deep well injection sites for disposal, and transfer finished water to the injection well sites (for IPR projects) or distribution systems (for DPR projects). Treatment costs include all costs associated with constructing the treatment needed to create water fit for IPR or DPR. Note that IPR costs for the project options include two infrastructure cost options for piping to the identified 6-month injection site and 12-month injection site.

A summary of the total project costs for the Solvang and Buellton projects, as well as annualized costs, are shown in Table ES.4.

Table ES.4 Solvang and Buellton AWPf Capital Cost Estimates

Project	Cost Item	Total Project Cost		
		IPR (6 Month Conveyance Pipeline)	IPR (12 Month Conveyance Pipeline)	DPR
Solvang AWPf	Infrastructure	\$38,460,000	\$42,300,000	\$23,660,000
	Treatment	\$136,670,000	\$136,670,000	\$175,130,000
	Total Project Capital Cost	\$175,130,000	\$178,970,000	\$199,360,000
	Annualized Total Project Cost⁽¹⁾	\$9,522,000	\$9,731,000	\$10,839,000

Project	Cost Item	Total Project Cost		
		IPR (6 Month Conveyance Pipeline)	IPR (12 Month Conveyance Pipeline)	DPR
Buellton AWWP	Infrastructure	\$22,170,000	\$23,820,000	\$16,460,000
	Treatment	\$47,910,000	\$47,910,000	\$75,420,000
	Total Project Capital Cost	\$70,080,000	\$71,730,000	\$91,880,000
	Annualized Total Project Cost⁽¹⁾	\$3,810,000	\$3,900,000	\$4,996,000
Solvang/Buellton Combined AWWP	Infrastructure	\$59,930,000	\$61,880,000	\$41,150,000
	Treatment	\$137,760,000	\$137,760,000	\$177,990,000
	Total Project Capital Cost	\$197,690,000	\$199,640,000	\$219,140,000
	Annualized Total Project Cost⁽¹⁾	\$10,749,000	\$10,855,000	\$11,915,000

Notes:

(1) Calculated assuming an interest rate of 3.5 percent and annualized over 30 years.

If the Solvang permit negotiations are successful, then the large 4.3 million gallons (MG) EQ basin would be removed from the project and the AWWP could be shrunken down to treat ADWF only (reducing capacity from 1 mgd to 0.59 mgd). The net result is an **approximately 60 percent reduction in the total project treatment cost for the Solvang-only project and approximately 55 percent reduction for the Solvang/Buellton combined project.**

Capital costs for the SSD project options evaluated include all infrastructure needs to transfer raw wastewater from the SSD WWTP site to the CSD collection system. A summary of the total project costs for the SSD projects, as well as annualized costs, is shown in Table ES.5.

Table ES.5 SSD Capital Cost Estimates

Cost Item	Total Project Cost	
	0.2 mgd Equalized Flow to CSD	0.47 mgd Equalized Flow to CSD
New Pipe From SSD to CSD	\$6,591,000	\$9,434,000
Upsized CSD Piping	\$151,000	\$644,000
Pump Station	\$1,469,000	\$3,996,000
New 0.47 MG EQ Basin	\$9,120,000	-
Rehab Existing EQ Basin	-	\$441,000
Odor Control System	\$869,000	\$623,000
Screenings and Conveyor Facility	\$1,679,000	\$1,679,000
Total	\$19,880,000	\$16,820,000

ES.7.2 Operations and Maintenance Costs

Operations and maintenance (O&M) costs were developed for the Solvang and Buellton AWWP facility scenarios. These O&M costs include power consumption, chemical consumption, maintenance, and staffing. These costs are divided into the following categories:

- Infrastructure costs.
- Treatment costs.

A summary of these O&M costs is shown in Table ES.6.

Table ES.6 Solvang and Buellton Annual O&M Cost Estimates

Project	Cost Item	Annual O&M Cost		
		IPR (6 Month Conveyance Pipeline)	IPR (12 Month Conveyance Pipeline)	DPR
Solvang AWPf	Annual Infrastructure O&M	\$422,000	\$442,000	\$291,000
	Annual Treatment O&M	\$1,087,000	\$1,087,000	\$1,540,000
	Total Annual O&M	\$1,509,000	\$1,529,000	\$1,831,000
Buellton AWPf	Annual Infrastructure O&M	\$169,000	\$177,000	\$117,000
	Annual Treatment O&M	\$870,000	\$870,000	\$1,371,000
	Total Annual O&M	\$1,037,000	\$1,047,000	\$1,488,000
Solvang/Buellton Combined AWPf	Annual Infrastructure O&M	\$587,000	\$596,000	\$436,000
	Annual Treatment O&M	\$1,310,000	\$1,310,000	\$1,864,000
	Total Annual O&M	\$1,897,000	\$1,906,000	\$2,300,000

If the Solvang permit negotiations are successful, then the large 4.3 MG EQ basin would be removed from the project and the AWPf could be shrunk down to treat ADWF only (reducing capacity from 1 mgd to 0.59 mgd). The net result is an approximately **15 percent reduction in annual O&M cost for the Solvang-only project** due to a smaller operating AWPf. There is little to no anticipated reduction in O&M cost for the Solvang/Buellton combined project as that AWPf sizing would not change.

O&M costs were also developed for the SSD project scenarios. These O&M costs include power consumption and maintenance associated with the required infrastructure. A summary of these O&M costs is shown in Table ES.7.

Table ES.7 SSD Annual O&M Cost Estimates

Cost Item	Annual O&M Cost	
	0.2 mgd Equalized Flow to CSD (\$/year)	0.47 mgd Equalized Flow to CSD (\$/year)
Power	\$73,000	\$153,000
Annual Maintenance ⁽¹⁾	\$99,000	\$84,000
Odor Control Media Replacement	\$5,000	\$1,000
Total	\$177,000	\$238,000

Notes:

(1) Annual maintenance estimated as 0.5 percent of total capital costs.

\$ - dollars

ES.7.3 Unit Costs

Unit costs were developed in dollars per MG of finished water produced and dollars per acre-foot (ac-ft) of finished water produced for each AWPf scenario for the Solvang and Buellton project alternatives. These unit costs are shown in Table ES.8.

Table ES.8 Solvang and Buellton AWWP Unit Cost Estimates

Project	Cost Item	Unit Cost ⁽¹⁾		
		IPR (6 Month Conveyance Pipeline)	IPR (12 Month Conveyance Pipeline)	DPR
Solvang AWWP	\$/ac-ft	\$21,500	\$21,900	\$26,400
	\$/MG	\$65,800	\$67,100	\$80,800
Buellton AWWP	\$/ac-ft	\$13,200	\$13,400	\$18,700
	\$/MG	\$40,300	\$41,100	\$57,300
Solvang/Buellton Combined AWWP	\$/ac-ft	\$14,500	\$14,700	\$17,400
	\$/MG	\$44,500	\$44,900	\$53,400

Notes:

(1) Calculated using the annualized capital cost, annual O&M cost, and assuming the facility is running at capacity 365 days per year.

If the Solvang permit negotiations are successful, then the large 4.3 MG EQ basin would be removed from the project and the AWWP could be shrunken down to treat ADWF only (reducing capacity from 1 mgd to 0.59 mgd). The net result is an approximately **35 percent reduction in the unit cost for the Solvang-only project and approximately 30 percent reduction for the Solvang/Buellton combined project.**

Unit cost was not calculated for the SSD project as this is dependent on the CAPP purification costs, which are under development as part of design.

ES.8 Implementation Plan

The IPR timeline has been divided into three phases: planning, demonstration, and operations and operator training. Key elements of each phase are denoted in the timeline presented on Figure ES.2.

Project Phase	Year						
	1	2	3	4	5	6	7
Planning							
Project Visioning							
Feasibility Study							
Outreach							
Grant Funding							
Implementation							
Permitting							
Pre-Design (Basis of Design Report)							
Design							
Procurement							
Construction							
Operations & Operator Training							
AWTO Training and Certification							
AWPF Full Scale Operations							

Figure ES.2 Potential IPR Implementation Timeline Based on Three Main Project Phases

The DPR timeline, presented on Figure ES.3, has been divided into four phases. Three of the four phases (planning, implementation, and operations and operator training) are similar to those required in the IPR timeline. The additional phase, demonstration and public outreach, is geared towards validating the project concept through demonstration and engaging with the public, stakeholders, and regulators. While these steps are also key to an IPR project, the level of effort and engagement for a DPR project is much more extensive. Similar to the IPR project, the operations/operator training accounts for the time required to achieve AWTO certifications. While AWTO certifications are required for the CPO and lead shift operator for IPR projects, the degree of AWTO certified operators required for DPR implementation is much more extensive.

Although these four phases are ordered generally in sequence, there is overlap between them and some activities continue throughout the life of the project. Throughout the implementation timeline there are elements that can result in schedule delays or increased uncertainty; these challenges, such as consensus on the project, water supply need, and public perception, are discussed in further detail in Chapter 7.

Project Phase	Year										
	1	2	3	4	5	6	7	8	9	10	11
Planning											
Project Visioning											
Feasibility Study											
Outreach											
Independent Advisory Panel											
Grant Funding											
Demonstration & Public Outreach											
Goal Setting											
Design											
Construction											
Operation											
Implementation											
Permitting											
Pre-Design (Basis of Design Report)											
Design											
Procurement											
Construction											
Operations & Operator Training											
T3 - T5 Operators Staff Development											
AWTO Training and Certification											
AWPF Full Scale Operations											

Figure ES.3 Potential DPR Implementation Timeline Based on Four Main Project Phases

CHAPTER 1 INTRODUCTION

1.1 Background and Purpose

The County Board of Supervisors directed County engineering staff to evaluate the potential for potable water reuse using the effluent from the municipal wastewater treatment facilities in the County. This high-level evaluation documents and summarizes what each of the wastewater treatment utilities in the County are doing regarding treatment (wastewater and advanced processes) and the end use of that water (water reuse, effluent disposal, including both location and volume). In addition, four potable reuse projects were evaluated within the County, where significant new water can be obtained for potable reuse and/or where current or recent potable reuse studies have not been completed. These four projects considered both IPR and DPR.

1.2 Evaluation Study Area and Summary

The County is located along the central coast of California about 90 miles northwest of Los Angeles. The County has a total area of 3,789 square miles and, as of the 2020 United States (US) Census, is home to approximately 448,000 residents. The main population centers within the County are the cities of Santa Maria and Santa Barbara, each with approximately 100,000 residents. The study area for this project is limited to utilities within the County limits.

Initial work on this study began with a questionnaire delivered to the 18 wastewater utilities within the County to gather high-level information on their respective wastewater systems, existing or planned water reuse programs, and community drinking water supply. Through this survey process, key information about available wastewater flows and existing or future water supply needs was captured. Figure 1.1 shows a map of the wastewater utilities surveyed.

Data from the questionnaire was reviewed to select the four potable reuse projects to evaluate within this study. For those utilities who did not already have a planned or implemented reuse program, projects were selected based on utility interest, flow available for reuse, and community water supply needs. The projects evaluated within this study are as follows:

1. City of Buellton – Individual AWPF.
2. City of Solvang – Individual AWPF.
3. Buellton-Solvang Joint AWPF (to be sited at the City of Buellton’s WWTP).
4. SSD – Raw Wastewater Transfer to CSD for Subsequent Planned Carpinteria IPR AWPF.

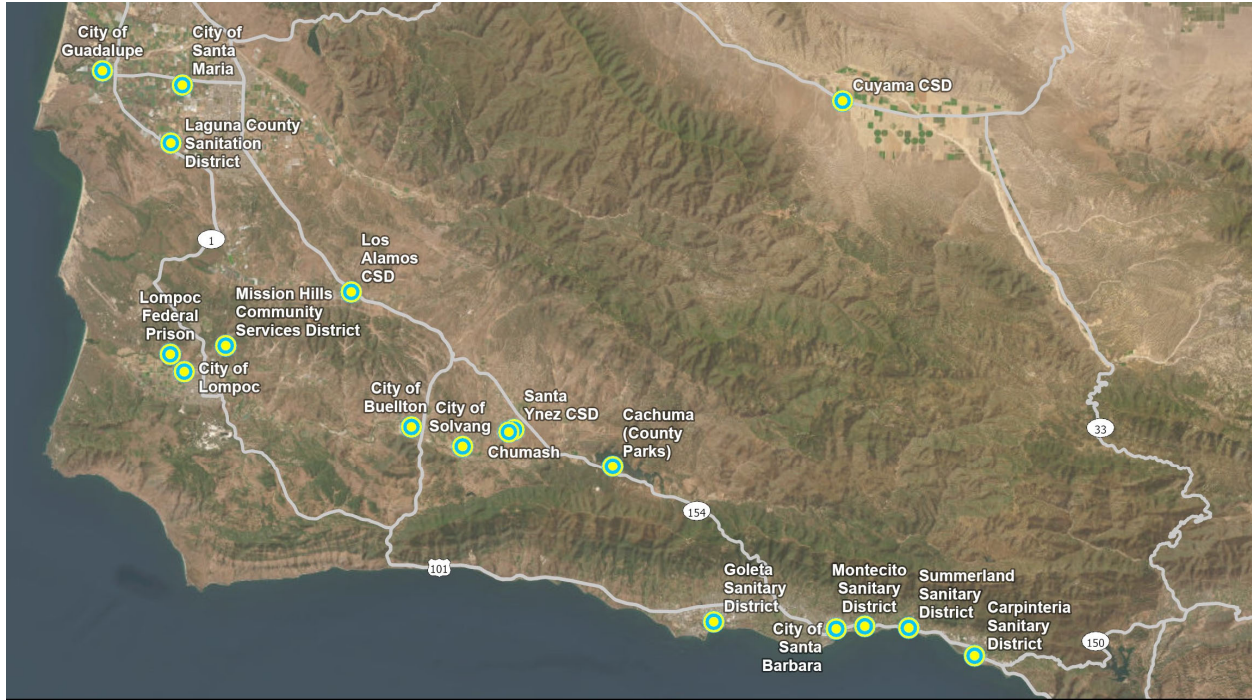

Figure 1.1 Santa Barbara County Wastewater Utilities

This study evaluates the treatment and infrastructure needs of each of these projects. For the Buellton, Solvang, and Buellton-Solvang Joint AWWPfs, both IPR and DPR feasibility was evaluated. Current and developing regulatory considerations for both treatment options were considered. The California Division of Drinking Water (DDW) anticipates finalizing DPR regulations in the State of California by the end of 2023 for adoption in 2024. For the DPR projects, this study assesses the current draft DPR regulations to determine the feasibility of the construction of a DPR facility.

The SSD project evaluates infrastructure required to transfer raw wastewater flow from the SSD WWTP site to the CSD collection system. Transferred flow would travel to the CSD WWTP for treatment and subsequent advanced treatment at their planned IPR project.

1.3 Report Organization

This report is organized as follows:

- **Executive Summary:**
 - » *Summary of each of the report chapters including key findings.*
- **Chapter 1 - Introduction:**
 - » *Summary of project background and purpose.*
- **Chapter 2 - Summary of Existing Information:**
 - » *Wastewater utility questionnaire findings.*
 - » *Summary of water quality and quantity data for selected utilities.*

- **Chapter 3 - Regulatory Summary:**
 - » *Overview of potable reuse types.*
 - » *Current IPR regulations for California.*
 - » *Draft DPR regulations for California.*
- **Chapter 4 - Treatment Summary:**
 - » *Proposed IPR and DPR treatment trains for the Solvang and Buellton projects.*
 - » *Preliminary design criteria for Solvang and Buellton projects.*
 - » *AWPF layouts for the Solvang and Buellton projects.*
 - » *Description of advanced treatment processes.*
- **Chapter 5 - Water End Use and Necessary Infrastructure:**
 - » *Summary of end destinations within the County for different potable reuse types.*
 - » *Infrastructure sizing and layouts for required piping, pumping, and tanks for each evaluated project.*
- **Chapter 6 - Reverse Osmosis Concentrate Disposal:**
 - » *Overview of ROC disposal options.*
 - » *Analysis of potential deep well injection sites for ROC disposal from the Solvang and Buellton projects.*
- **Chapter 7 - Planning Level Costs:**
 - » *Presentation of expected capital and O&M costs for the evaluated projects.*
 - » *Project implementation timelines, including identification of major project phases and potential schedule challenges.*

CHAPTER 2 SUMMARY OF EXISTING INFORMATION

2.1 Introduction

Throughout the County, a handful of utilities are: (a) implementing potable water reuse or (b) considering future potable water reuse. No utilities in the County are currently operating potable reuse facilities. This project seeks to evaluate new potable reuse opportunities, beyond what is already being done. This chapter reviews the process to determine which four (per contract) County projects to evaluate for potable water reuse as part of this project.

2.2 Utility Selection Process

The 18 wastewater utilities in the County were sent a two-page survey to gather high-level information on their respective wastewater systems, existing or planned water reuse programs, and community drinking water supply. Through this survey process, key information about available wastewater flows and existing or future water supply needs was captured. The questionnaires were completed through a combination of utility input and by Carollo Engineers (Carollo) through summary of previously completed reports. Questionnaires were received from, or were able to be completed on behalf of, 14 of the 18 utilities,¹ including City of Buellton, CSD, Cuyama Community Services District, Goleta Sanitary District (GSD), City of Guadalupe, Laguna County Sanitation District (LCSD), City of Lompoc, Lompoc Federal Prison, Los Alamos Community Services District (LACSD), Montecito Sanitary District (MSD), City of Santa Barbara, Santa Barbara County Community Services Department – Park Division (Lake Cachuma), City of Santa Maria, City of Solvang, SSD, Santa Ynez Community Services District, and the Santa Ynez Band of Chumash Indians. A compilation of utility data received, as well as each completed survey, is available in Appendix A. Through this process, a small subset of utilities was selected for detailed potable water reuse analysis.

2.2.1 Basis for Potable Reuse Project Selection

Data received from the questionnaire was reviewed and analyzed to determine the four potable reuse projects to study for this project. Key questionnaire components used to select the four projects were as follows:

- **Utility interest:** Utilities selected are required to provide data, participate in project meetings, and review materials produced throughout the project. For this reason, utilities not actively interested in pursuing potable reuse in their community, for whatever reason, were removed from consideration.
- **Flow available:** Available flow was evaluated to determine the cost effectiveness of implementing a potable reuse project. No project is specifically too small, but there is a significant economy of scale

¹ Some of the utilities did not provide survey responses, including Cuyama Community Services District, Lompoc Federal Prison, Santa Barbara County Community Services Department – Park Division (Lake Cachuma), and Santa Ynez Community Services District. Accordingly, these facilities are not included in this evaluation.

for larger potable reuse projects compared to smaller projects. Thus, all things being equal, larger projects will have priority compared to smaller projects.

- **Planned potable reuse program:** Several utilities in the County have already undertaken their own, separate analysis of indirect or direct potable reuse implementation feasibility. As this study is seeking to provide a similar type of analysis for new opportunities, utilities who had already completed similar studies were removed from consideration.
- **Community water supply:** The primary driver for implementing a potable reuse program is to provide a new, resilient water supply for the community. As the County has a very diverse water supply portfolio, communities throughout are facing different levels of water scarcity. Utilities not anticipating water supply shortages in the next 15 years were removed from consideration.

After review of questionnaire data and consultation with County staff and follow-up calls with utility staff, the following projects were selected for evaluation:

1. City of Buellton – Individual AWPF.
2. City of Solvang – Individual AWPF.
3. Buellton-Solvang Joint AWPF.
4. SSD – Raw Wastewater Transfer to CSD for Subsequent Planned Carpinteria IPR AWPF.

The following subsections detail key findings for each utility that completed the survey that were used to form a basis for either selecting the utility to be evaluated for potable reuse or removing from consideration.

2.2.1.1 City of Buellton

The City of Buellton currently receives approximately 0.5 mgd of ADWF to their local WWTP. Effluent is discharged to percolation ponds adjacent to their WWTP. Buellton does not have a current or planned water reuse program.

Basis for Selection

Buellton was selected for evaluation due to available effluent flow, water supply need, and utility interest. In addition to being evaluated individually, a combined facility utilizing the wastewater effluent from the City of Buellton and City of Solvang will also be evaluated.

2.2.1.2 Carpinteria Sanitary District

CSD receives approximately 1.1 mgd of ADWF at their WWTP. None of the effluent is currently reused, with it all being discharged to an ocean outfall.

Basis for Elimination

After significant study, the Carpinteria Valley Water District (CVWD) and the CSD have decided to move ahead with an IPR project, called the CAPP.² The CAPP aims to purify recycled water and use it to replenish the groundwater basin, creating a new source of drinking water that is drought-resistant and

² CVWD and CSD (2021). Carpinteria Advanced Purification Project, June 17, 2021. <https://cwwd.net/capp/>.

locally-controlled. The project involves purifying fully treated wastewater using a multi-step process in a new AWWP, storing it in the groundwater basin, and using it as an IPR source.

The project involves taking water that has already been treated at the CSD WWTP, up to 1.3 mgd, purifying that water resulting in approximately 1.1 mgd of new water, and transporting the purified water via pipeline to injection wells for storage in the Carpinteria Valley Groundwater Basin. The new purified recycled water (PRW) supply could fulfill over a quarter of the water needs of the CVWD.

The CAPP is presently in the phase of engineering design and is anticipated that construction could commence in 2024 and conclude by 2026. Table 2.1 shows the project size and status for the CAPP.

Table 2.1 CSD Planned Project Summary

Size of Project	Phase of Project	Certainty of Implementation
1,238 AFY	Design	Certain. Project is funded and under design.

Notes:

AFY - acre-feet per year

The full-scale project is being implemented in Carpinteria to utilize most (nearly all) of the CSD treated effluent. Accordingly, there is no need for further study of a Carpinteria-only project. As noted below, there are regional partnership opportunities that could expand the IPR project in Carpinteria.

One example, being explored as a part of this study, is adding new wastewater flows to the CSD WWTP from the adjacent SSD (discussed further below). Another potential partnership opportunity, not explored as a part of this project would be adding new PRW to the Carpinteria Groundwater Basin from a Montecito-based advanced treatment facility. The Montecito-based supply option was studied separately by the MSD and is discussed in further detail in Section 2.2.1.9.

2.2.1.3 Goleta Sanitary District

GSD receives approximately 4.0 mgd of ADWF at their local WWTP. Effluent is discharged to an ocean outfall. The influent water is received from the County of Santa Barbara Camino del Remedio Campus, Goleta West Sanitary District, and El Embarcadero Municipal Improvement District. The GSD in cooperation with Goleta Water District (GWD) has a non-potable reuse (NPR) program in place, producing approximately 1.25 mgd of Title 22 water for irrigation uses throughout the service area.

Basis for Elimination

In order to assess project eligibility, GWD was contacted to discuss the water supply need within GWD's service territory. GWD indicated there was not a pressing need to further develop potable reuse within GWD at this time, and GWD has completed a full Feasibility Study of potable reuse within its boundaries previously in 2017. Key rationale are as follows:

- **Water supply:** The primary water supply for GWD service area is from Lake Cachuma. Groundwater is utilized when Cachuma water is unavailable. During the storm events in early 2023, GWD has been able to inject extra Lake Cachuma water into the underlying groundwater basin. The basin is nearly full from the additional storm infiltration and these injections.
- **Water demand:** GWD indicated that projections do not indicate a water supply deficit within the next 20 to 30 years. This includes the projected added dwelling units that will be added per the Regional Housing Needs Allocation.

- **Previous studies:** Previous recent studies indicated that pursuing an IPR project would be infeasible due to cost, lack of available storage, and contamination concerns. As noted, the underlying groundwater basin is already nearing capacity and could not store large volumes of PRW. In addition, GWD noted that there are areas of groundwater contamination throughout the basin, such as near the local airport. There is concern that injection of PRW would cause the contamination plumes to migrate. GWD indicated that DPR had also been studied before and had a high cost. Given that there is no immediate water supply need, this was eliminated from consideration as well.
- **Local ordinances:** In 1991, GWD authorized participation in the State Water Project (SWP). With this authorization came the passage of the *Safe Water Supplies Ordinance 91-01*.³ Implementation of a potable reuse program within the GWD service area may come into conflict with provisions of this ordinance and may also need a passing public vote to pursue.

For these reasons, GSD was removed from consideration for this project. GWD did note that interest may change in the future should there be a change to supply projections. A decrease in available Lake Cachuma supplies would be the most likely trigger for GSD and GWD to reconsider potable reuse.

2.2.1.4 City of Guadalupe

The City of Guadalupe receives approximately 0.8 mgd of ADWF at their local WWTP. Effluent is land applied. Guadalupe has an NPR program in place, producing approximately 0.7 mgd of Title 22 water for irrigation use for fodder on adjacent ranch land.

Basis for Elimination

Assuming Guadalupe's existing NPR program remains in place, there is only a very small amount of wastewater effluent available to develop into a cost-effective IPR or DPR project. In addition, implementation of an IPR project in Guadalupe will impose too significant a technical, managerial, and financial burden. Finally, Guadalupe is not optimally situated near other utilities or cities to pursue a combined reuse project, which would reduce cost or staffing limitations. This could be reevaluated in the future should an adjacent utility, such as the City of Santa Maria, decide to pursue a potable reuse program.

2.2.1.5 Laguna County Sanitation District

LCSD receives approximately 1.7 mgd of ADWF to their water reclamation plant (WRP). LCSD has a NPR program in place, utilizing all of their effluent for irrigation use throughout the service area including reuse on LCSD property.

Basis for Elimination

LCSD is currently performing a detailed IPR project evaluation which will detail the costs for three different sizes of IPR projects described below. The existing WRP consists of two parallel treatment trains that evolved for the purpose of treating both high and low sodium/chloride concentrations. Effluent is blended from these two trains and treated to Title 22 standards. The evaluation underway consists of

³ GWD (1991). *Safe Water Supplies Ordinance 91-01*.
https://www.goletawater.com/assets/uploads/documents/other/SAFE_ORDINANCE.pdf.

three different IPR projects which seek to utilize existing WRP assets wherever possible. The three projects that will be evaluated and costed are as follows:

- **Project 1:** 0.5 mgd of feed flow will be conveyed to the existing membrane bioreactor (MBR), RO, and UV disinfection equipment utilized in the high-sodium/chloride-removal treatment trains that can be repurposed for a fast-track early phase IPR project. PRW (0.43 mgd) will be discharged into injection wells and will have no impact on the existing NPR system. Upgrades will not be required to the existing ROC discharge pipeline.
- **Project 2:** This project will also utilize the existing high-sodium/chloride-removal treatment processes with a larger quantity of feed flow. 1.35 mgd of feed flow will be conveyed to the existing MBR, RO, and UV equipment which will ultimately be phased to a large facility. The 1.15 mgd production capacity for this phase is limited by the existing ROC pipeline capacity. The existing NPR system can continue to operate for the initial phase of this project, with reduced NPR flows as the IPR treatment capacity is upgraded.
- **Project 3:** This project will utilize the maximum available feed flow (1.7 mgd) to produce 1.45 mgd of PRW. This project will phase out the existing NPR system and a new parallel ROC pipeline will be constructed for added disposal capacity.

Table 2.2 shows the planned project size and status for the LCSD IPR project.

Table 2.2 LCSD Planned Project Summary

Size of Project	Phase of Project	Certainty of Implementation
476 AFY	Planning	High potential, but no commitments at this time.
1,285 AFY	Planning	Potential expansion of the smaller initial project.
1,619 AFY	Planning	Potential expansion of the smaller initial project.

2.2.1.6 City of Lompoc

The City of Lompoc receives approximately 3.1 mgd of ADWF to the Lompoc Regional Wastewater Reclamation Plant (LRWRP). The water is received from Vandenberg Village Community Services District and Vandenberg Space Force Base. Lompoc produces a small amount of recycled water for local construction uses including dust control and compaction. The current recycled water program is administered under the *State Water Board General Order WQ 2016-0068-DDW* and is limited to a maximum sale of 62,000 gallons of recycled water per day. Produced recycled water is trucked and can only be used within 30 miles of the LRWRP. As of Lompoc's most recent Urban Water Management Plan, Lompoc is producing 20,000 gallons per day (gpd) of recycled water for one user.⁴ The remaining effluent is discharged to the San Miguelito Creek, a tributary to the Santa Ynez River.

Basis for Elimination

Discharge to San Miguelito Creek provides downstream benefit to the Santa Ynez River and groundwater recharge to the Lompoc Plain sub-basin. Likely due to instream flow requirements, input from the city on the questionnaire indicated that they are limited to diverting 62,000 gpd of effluent and this has proven

⁴ Water Systems Consulting, Inc. (2021). City of Lompoc 2020 Urban Water Management Plan, June 15, 2021. <https://www.cityoflompoc.com/home/showpublisheddocument/32302/637608244534770000>.

to be difficult to recover testing and compliance costs even for their existing compliance costs. Lompoc was eliminated from this study due to lack of interest and low available effluent.

2.2.1.7 Los Alamos Community Services District

LACSD receives approximately 0.1 mgd of ADWF at their local WWTP. Effluent is land applied, with no reuse program currently in place.

Basis for Elimination

Based on the flow data provided, there is a very small amount of wastewater effluent available to develop into a cost-effective IPR or DPR project. In addition, LACSD is not optimally situated near other utilities or cities to pursue a combined reuse project, which may alleviate cost or staffing limitations. The remote location of LACSD makes a combined project unlikely.

2.2.1.8 Mission Hills Community Services District

Mission Hills Community Services District (MHCS D) receives approximately 0.2 mgd of ADWF at their local WWTP. Effluent is land applied, with no reuse program currently in place.

Basis for Elimination

Based on the flow data provided, there is a very small amount of wastewater effluent available to develop into a cost-effective IPR or DPR project. In addition, MHCS D is not optimally situated near other utilities or cities to pursue a combined reuse project, which may alleviate cost or staffing limitations. This could be reevaluated in the future should an adjacent utility, such as the City of Lompoc, decide to pursue a potable reuse program.

2.2.1.9 Montecito Sanitary District

MSD receives approximately 0.7 mgd of ADWF to their WWTP. None of the effluent is reused, with it all being discharged to an ocean outfall. MSD recently partnered with Montecito Water District (MWD) to provide a detailed evaluation of NPR, IPR, and DPR.

Basis for Elimination

MSD and MWD completed an *Enhanced Recycled Water Feasibility Analysis* in January 2023.⁵ Because MSD has already studied potable reuse implementation, it was removed from consideration for participation in this study as the work would be redundant.

The January 2023 analysis considered local and regional partnerships (with Santa Barbara, with Carpinteria, and locally), non-potable and potable reuse alternatives, and various treatment methods and technologies. The evaluation considered:

- **NPR in Montecito:**

- » *While more cost effective, the amount of water recovered for NPR was too small to bring value to MWD.*

⁵ Carollo (2023). *Enhanced Recycled Water Feasibility Analysis*, prepared for MSD and MWD, January 2023.

▪ **IPR and DPR in Montecito:**

- » *IPR in Montecito is not feasible due to the lack of a sufficiently large groundwater basin and lack of proximity to a large raw water reservoir. In addition, there is a high quantity of private wells within the area, making it difficult to find an area for injection and extraction that will not impact the private property rights in the basin.*
- » *DPR in Montecito is not feasible due to uncertainty with future DPR regulations at the time of study completion, preferring not to be one of the first agencies in the State to pursue a complex project of this nature, and the long project implementation timeline that would be required.*

▪ **DPR in Santa Barbara:**

- » *DPR in the City of Santa Barbara included co-mingling of wastewater into the Santa Barbara collection system and purification in Santa Barbara.*
- » *While the lowest cost option (due to economy of scale), this DPR project was not selected due to the uncertainty of future implementation by the City of Santa Barbara.*
- » *DPR in the City of Santa Barbara is not feasible because of the uncertainty with future DPR regulations at the time of study completion, Santa Barbara’s lengthy projected DPR timeline of 10 to 15 years, the uncertainty of Santa Barbara’s pursuit of DPR in the future, and concerns that pursuit of this option would lead to Montecito’s overreliance on a single source or strategy.*

▪ **IPR in Carpinteria:**

- » *Multiple options of pursuing IPR in Carpinteria were evaluated. The selected IPR in Carpinteria concept would purify MSD effluent at MSD and send PRW into the Carpinteria Groundwater Basin:*
 - This option maximizes use of MSD effluent and allows for MWD to control the project timeline.
 - **This project concept was selected as the preferred option for this Montecito project.**

This preferred project concept is a regional project in which MSD and MWD produce PRW and send it to Carpinteria for injection into the Carpinteria Groundwater Basin. This project entails a partnership with neighboring special district(s) including CVWD and the Carpinteria Groundwater Sustainability Agency. Implementation of this project would provide approximately 504 AFY of water for use by MWD.

MWD is currently pursuing grant funding to cover the next phase of work, which would be 30 percent design and California Environmental Quality Act (CEQA) efforts. Implementation of the full project remains uncertain and depends upon water supply need, development of regional partnerships, and cost. Should the project proceed, it could be operational by 2027/2028. Project size and status are detailed in Table 2.3.

Table 2.3 **MSD Planned Project Summary**

Size of Project	Phase of Project	Certainty of Implementation
504 AFY	Planning	Uncertain

2.2.1.10 City of Santa Barbara

The City of Santa Barbara receives approximately 7.0 mgd of ADWF at their local El Estero Water Resource Center (WRC). Influent water is received from County Service Area 12 and MSD (Sycamore Canyon Road). Effluent is discharged to an ocean outfall. Santa Barbara has a NPR program in place, producing approximately 0.6 mgd of Title 22 water for irrigation uses throughout the city.

Basis for Elimination

The City of Santa Barbara completed a *Potable Reuse Feasibility Study* in March 2017⁶ as well as a subsequent *Recycled Water Market Assessment* in August 2022.⁷ Because the City of Santa Barbara has already studied potable reuse implementation, it was removed from consideration for participation in this study as the work would be redundant.

The March 2017 analysis studied the design considerations, cost, and maximum yield of both IPR and DPR alternatives to determine if potable reuse could be a feasible replacement to Santa Barbara's desalinated water supply, produced at the Charles E. Meyer Desalination Plant. Combinations of different yields of NPR, IPR, and DPR projects were evaluated to generate eight total alternatives for evaluation. The evaluation considered:

- **NPR within existing city system:**
 - » *The NPR alternatives considered were either continued use of the existing NPR system or use of part of the existing NPR system.*
 - » *For alternatives only purveying NPR water to part of the system, the other portion of the system would be utilized to convey IPR or DPR water.*
 - » *In some alternatives, the NPR system is removed altogether and replaced with IPR, DPR, or a combination, utilizing the existing NPR distribution system.*
- **IPR:**
 - » *IPR alternatives considered assumed injection wells or spreading basins.*
- **DPR:**
 - » *Two DPR projects were considered:*
 - Provide advanced treatment at a new AWPf and then transport water to Lauro Reservoir. Water would then be retreated at the Cater WTP for ultimate use within the existing distribution system.
 - Provide advanced treatment at a new AWPf and then retreat the product water at a new WTP co-located at the existing desalination plant site.

The analysis screened the eight permutations of NPR, IPR, and DPR projects on a series of technical, economic, environmental, and social criteria. All the alternatives involving DPR were screened out due to technical infeasibility. The remaining alternatives were also screened out due to the inability to provide comparable yield to desalination. The resulting study did not provide a recommendation to pursue potable reuse at this time.

The August 2022 analysis built upon the findings of the 2017 report to evaluate the implementation of potable reuse, specifically DPR, via RWA at the Lauro Reservoir. This study also considers potential collaboration with MSD as one option. This analysis assumes a new AWPf would be constructed adjacent to the existing El Estero WRC and a new conveyance pipe would be constructed to convey water to Lauro Reservoir. Potential AWPf sizing for these efforts ranged from 3.7 mgd to 6.2 mgd. The lower range of this is reflective on winter potable water demand in the city and the highest is reflective of combined ADWFs from MSD and El Estero WRC.

⁶ Carollo (2017). Potable Reuse Feasibility Study, prepared for the City of Santa Barbara, March 2017.

⁷ Carollo (2022). Recycled Water Market Assessment Report, prepared for the City of Santa Barbara, September 2022.

The analysis compared the implementation of the DPR project to the planned increase of the city’s existing desalination plant. The study found that implementing the larger (6.2 mgd) AWPf would be cost effective in comparison to desalination while the smaller (3.7 mgd) AWPf would be less cost effective. Santa Barbara decided to hold on pursuing a potable reuse project due to the current surplus of water supply and the projected lack of need until 2035 for new supplies. Should either sized DPR project proceed, the project size and status are detailed in the Table 2.4 below.

Table 2.4 City of Santa Barbara DPR Project Summary

Size of Project	Phase of Project	Certainty of Implementation
6.2 mgd (6,900 AFY)	Planning	Unlikely in near-term, uncertain in long-term.
3.7 mgd (4,100 AFY)	Planning	Unlikely in near-term, uncertain in long-term.

2.2.1.11 City of Santa Maria

The City of Santa Maria currently receives approximately 7.3 mgd of ADWF to their local WWTP. Effluent is discharged to percolation ponds adjacent to their WWTP and percolates into the local groundwater basin. Santa Maria does not have a current or planned water reuse program in place.

Basis for Elimination

The City of Santa Maria overlays the Santa Maria Valley Groundwater Basin (SMVGB). The SMVGB was adjudicated in 2008 with management activities in accordance with provisions of the *Stipulation Entered in 2008 by the Superior County of the State of California, County of Santa Clara* (Stipulation). Provisions of the Stipulation dictate percentages of return flows that utilities who discharge to the SMVGB are entitled to (i.e., a water exchange). Based on the *2021 Annual Report of Hydrogeologic Conditions, Water Requirements, Supplies, and Disposition* prepared for the Santa Maria Valley Management Area, the city discharged 7,010 ac-ft to the SMVGB in 2021.⁸ In 2021, Santa Maria was entitled to pump 65 percent of their wastewater percolation for use as drinking water supply. Percent of return flows are based on SWP water use and change each year. After reviewing the basis of this project, the City of Santa Maria declined participation due to their reliance on the current wastewater percolation exchange for city water supply. Project size and status of the water exchange are detailed in Table 2.5.

Table 2.5 City of Santa Maria Water Exchange Project Summary

Size of Project	Phase of Project	Certainty of Implementation
Varies, but is approximately 65 percent of percolated flows (7,010 ac-ft in 2021), which can result in approximately 4,500 to approximately 5,000 AFY of water supply.	Implemented	N/A

Notes:

N/A - not applicable

⁸ Luhdorff & Scalmanini Consulting Engineers (2022). 2021 Annual Report of Hydrogeologic Conditions, Water Requirements, Supplies, and Disposition, prepared for the Santa Maria Valley Management Area, April 26, 2022.

2.2.1.12 Santa Ynez Band of Chumash Indians

The Santa Ynez Band of Chumash Indians currently receives approximately 0.1 mgd of ADWF to their Chumash Casino Resort WWTP. Using a post tertiary membrane filtration process, the utility produces a small amount of recycled water for local irrigation and industry application. The current recycled water program is administered under the *State Water Board General Order WQ 2014-0090-DWQ* and is limited to a maximum sale of 85,000 gallons of recycled water per day. Produced recycled water is allowed to be used on the Mooney and Escobar properties. The remaining effluent is discharged to Zanja de Cota Creek, a tributary to the Santa Ynez River.

Basis for Elimination

According to the provided flow data, the available volume of wastewater effluent for potential development of an economically viable IPR or DPR project is minimal. Additionally, the utility's geographic location does not lend itself favorably to pursuing a collaborative reuse initiative with nearby utilities or cities, which could potentially mitigate cost and personnel constraints. Moreover, the utility presently adheres to the Title 22 application by utilizing their treated wastewater for purposes such as irrigation and industrial applications.

2.2.1.13 City of Solvang

The City of Solvang currently receives approximately 0.7 mgd of ADWF to their WWTP. Influent water is received from the city service area as well as the Santa Ynez Community Service District service area. Effluent is discharged to percolation ponds adjacent to their WWTP. Solvang does not have a current or designed water reuse program. Solvang is currently working with the RWQCB to determine appropriate concentrate-based discharge limits for several parameters/constituents, including total dissolved solids (TDS), chloride, sulfate, boron, and total nitrogen in accordance with water quality goals for the underlying groundwater basin.

Basis for Selection

Solvang was selected for evaluation due to available effluent flow, water supply need, and utility interest. In addition, several proposed limits for the parameters noted in the work with the RWQCB cannot be met without advanced treatment. Exploring potable reuse for Solvang will serve a dual purpose of providing an alternative water supply to the city in addition to being in compliance with proposed discharge limits. In addition to being evaluated individually, a combined facility utilizing the wastewater effluent from the City of Solvang and City of Buellton will also be evaluated.

2.2.1.14 Summerland Sanitary District

The SSD receives less than 0.1 mgd of ADWF to their WWTP. Treated effluent is discharged to an ocean outfall. No water is currently reused.

Basis for Selection

The SSD was selected for evaluation due to available effluent flow, water supply need, utility interest, and proximity/ability to combine with another ongoing IPR project. The SSD project analysis will focus on diversion of all SSD raw wastewater into the CSD collection system, resulting in secondary treatment at

CSD's WWTP and subsequent purification and groundwater recharge as part of the CAPP. In this scenario, the existing SSD WWTP and ocean outfall would no longer be used.

2.3 Summary of Santa Barbara County Water Supply

The County administers an annual water supply survey to the 16 water purveyors in the County. For the purposes of this project, water supply survey results were analyzed from a recent historical dry year (2021) and a historical wet year (2019) to evaluate how supply sources shift under drought conditions.

Information from these surveys was analyzed to evaluate:

1. How water supply varies across the County.
2. How water supply for each community changes in response to drought.

The potable water supply in the County consists of 16 utilities. The major water supplies throughout the County consist of the following sources, all of which are treated potable quality water:

- **Groundwater:** Water pumped from the underlying groundwater basin via potable supply wells.
- **SWP Water:** Water delivered from Northern California.
- **Cachuma Project Water:** Water from floodwater storage of the nearby Santa Ynez River.
- **SWP-Cachuma Exchange Water:** Water delivered from the exchange of Cachuma Project water and SWP water to the Improvement District No. 1 service area.⁹
- **Desalination:** Water distributed from the City of Santa Barbara Charles Meyer Desalination Facility.

The proportion of water supply for each utility in the evaluated wet and dry year is discussed in Table 2.6 and are shown visually in Figure 2.1 and Figure 2.2, respectively.

Major countywide observations for water supply trends are as follows:

- Water supplies in municipalities to the northwest predominantly depend on groundwater and SWP. These utilities are located upstream of Lake Cachuma and cannot utilize the Cachuma Project.
- Dependence on Cachuma Project and other surface water supplies increases downstream of Lake Cachuma.
- SWP contributions to potable supplies increases in wet years in 9 utilities of the evaluated 16 utilities.
- No changes of reliance on wells are between wet and dry years in five utilities.

Overall, drought years result in a shift from surface water to groundwater, though not for all utilities. Having a reliable groundwater backup supply is not available to all utilities.

⁹ The Santa Ynez River Water Conservation District (SYRWCD), Improvement District No.1 was established in 1959 under the Water Conservation Law of 1931, to provide potable domestic and irrigation water within its boundaries. The District operates continuously and serves the communities of Santa Ynez, Los Olivos, Ballard, the Santa Ynez Band of the Chumash Indians, and the City of Solvang. It currently provides water directly to over 2,600 municipal and industrial customers, and around 97 agricultural customers. The district obtains water from various sources, including the Cachuma Project, SWP, Santa Ynez Uplands Groundwater Basin, and Santa Ynez River alluvium. The District's major activities include the acquisition, construction, operation, and maintenance of works and facilities to develop and use water resources for the benefit of its customers.

Table 2.6 County of Santa Barbara Potable Water Supplies

Utility	Dry Year	Wet Year	Notes
City of Buellton	The majority of Buellton's dry year potable supply comes from wells, with a significant contribution from the SWP as well.	The majority of Buellton's wet year potable supply comes from wells, with a significant contribution from the SWP as well.	Dry and wet year supplies are very similar for Buellton, with a slightly larger contribution from the SWP during wet years.
City of Cuyama	All of Cuyama's dry year supply comes from well water.	All of Cuyama's wet year supply comes from well water.	The potable supply composition does not change between wet and dry years.
City of Guadalupe	Almost all of Guadalupe's dry year supply comes from wells, with a very small contribution from SWP.	Wells and SWP both significantly contribute to Guadalupe's potable water supply during wet years.	In both cases, wells and the SWP are the only sources of potable water. Contribution from the SWP increases significantly during wet years.
City of Lompoc	Almost all of Lompoc's dry year supply comes from well water, with a very small contribution from other surface waters ⁽¹⁾ .	Almost all of Lompoc's wet year supply comes from well water, with all contribution from other surface waters ⁽¹⁾ .	The potable supply composition does not change between wet and dry years.
City of Santa Barbara	Most of Santa Barbara's dry year supply comes from the Cachuma Project, with contributions from desalination and other surface waters ⁽¹⁾ as well.	About half of Santa Barbara's wet year supply comes from other surface waters ⁽¹⁾ , with significant contributions from desalination and the Cachuma Project, and small contributions from well water and SWP.	Wet year supply has a much smaller contribution from the Cachuma Project and a much larger contribution from other surface waters ⁽¹⁾ compared to the dry year supply. Both have contributions from desalination, The wet year supply has two additional sources compared to the dry year supply - wells and SWP.
City of Santa Maria	The majority of Santa Maria's dry year supply consists of well water, with a significant contribution from SWP as well.	The majority of Santa Maria's wet year supply comes from SWP, with a significant contribution from well water as well.	Both wet and dry year supplies are composed of well water and SWP, however well water is the biggest contributor to dry year supplies and SWP is the biggest contributor to wet year supplies.
City of Solvang	Solvang's dry year supply consists of significant contributions from both wells and SWP.	The majority of Solvang's wet year supply comes from SWP, with smaller contributions from well water and other purchased water. ⁽²⁾	The contribution from the SWP increases and the contribution from well water decreases from dry year to wet year potable supply. Additionally, other purchased water sources ⁽²⁾ contributed to the wet year supply.
CVWD	Roughly half of Carpinteria's dry year supply comes from the Cachuma Project, with significant contributions from wells and the SWP.	The majority of the wet year potable supply comes from the Cachuma Project, with additional contributions from wells and the SWP.	Dry year and wet year potable supplies are similar, with a slightly larger contribution from the Cachuma Project during a wet year.

Utility	Dry Year	Wet Year	Notes
Golden State Water Company	Almost all of the dry year supply comes from wells, with a very small contribution from SWP.	Almost all of the wet year supply comes from wells, with a small contribution from SWP.	The wet and dry year potable supplies largely have the same makeup, with a slightly larger contribution from SWP during the wet year.
GWD	Most of Goleta's dry year supply comes from the Cachuma Project, with significant contributions from SWP and wells, and a very small contribution from other surface waters ⁽¹⁾ .	Most of Goleta's wet year supply comes from the Cachuma Project, with contributions from well and SWP.	Both wet and dry year supplies have the largest contribution from the Cachuma Project, with contributions from SWP and wells as well. Dry year supplies have a small additional contribution from other surface water. ⁽¹⁾
La Cumbre Mutual Water Company	The majority of La Cumbre's dry year supply comes from well water, with significant contributions from SWP and other purchased waters. ⁽²⁾	Wet year supply is made up of similar contributions from SWP and well water.	Both dry and wet year supplies have significant contributions from wells and SWP, and dry year supplies also contain other purchased water resources. ⁽²⁾
LACSD	All of Los Alamos' dry year supply consists of well water.	All of Los Alamos' wet year supply consists of well water.	The potable supply composition does not change between wet and dry years.
MHCSD	All of Mission Hill's dry year supply comes from well water.	All of Mission Hill's wet year supply comes from well water.	The potable supply composition does not change between wet and dry years.
MWD	MWD's dry year supply comes from desalination, the Cachuma Project, other surface waters ⁽¹⁾ , and some well water.	During wet years, SWP or groundwater is not utilized. In a typical wet year, water supply will come from desalination, the Cachuma Project, and other surface water supplies. ⁽¹⁾	MWD relies on desalination for approximately one-third of their water supply regardless of year. Cachuma Project water and other surface water supplies ⁽¹⁾ are also used regardless of year.
SYRWCD "ID #1"	The biggest contribution to the dry year potable supply is well water, with a significant contribution from SWP Cachuma exchange as well.	Most of Santa Ynez's wet year supply comes from SWP Cachuma exchange, with contributions from well water and SWP.	Both wet and dry year supplies contain large contributions from SWP Cachuma Exchange. Well water is a large portion of the dry year supply and a small portion of the wet year supply. The wet year supply also has contributions from SWP.
Vandenberg Village Community Services District	All of Vandenberg Village's dry year supply comes from well water.	All of Vandenberg Village's wet year supply comes from well water.	The potable supply composition does not change between wet and dry years.

Notes:

- (1) "Other surface water" refers to all surface water resources besides Cachuma Project water.
- (2) "Other purchased water" refers to all purchased water resources besides SWP water.

DRY YEAR POTABLE SUPPLY (2021)



Figure 2.1 Proportion of Dry Year (2021) Potable Supply for 16 Utilities in Santa Barbara County

WET YEAR POTABLE SUPPLY (2019)



Figure 2.2 Proportion of Wet Year (2019) Potable Supply for 16 Utilities in Santa Barbara County

2.4 Select Utility Flow and Water Quality

A summary of available flow and water quality from the three selected utilities (Solvang, Buellton, and SSD) is presented below. This information will be used for the sizing of advanced treatment systems and required infrastructure for potable reuse.

2.4.1 Effluent Water Quality Data

Understanding WWTP effluent quality is essential for the utility's discharge permit which controls water pollution by regulating the discharge of pollutants from point sources into waters but also is important for the AWPf as it provides the necessary information for designing and optimizing the treatment processes.

WWTPs in California are either permitted under an NPDES permit or a Waste Discharge Requirement (WDR) permit. Examining the utilities evaluated in this report, SSD and CSD are both permitted under NPDES permits. Their wastewater effluent discharges to an ocean outfall. Permitted limits for NPDES dischargers to the Pacific Ocean are set in accordance with the *California Ocean Plan*.¹⁰ The cities of Solvang and Buellton both discharge their wastewater effluent to percolation ponds. Treated wastewater is disposed of by percolating into the underlying groundwater basin. This discharge is permitted under a WDR permit. Permitted limits for these respective WDR permits are both governed by the *Central Coast Basin Plan* which sets water quality limits to protect the underlying groundwater basin.¹¹

The following summarizes key considerations for both permitting and AWPf design:

- **Regarding Wastewater Discharge Permitting:** ROC contains high levels of salts, minerals, and other contaminants that can reach or exceed NPDES limits in some cases. The effluent water quality data provides important information that is used to estimate chemical levels in the ROC. For the Solvang and Buellton efforts, the ROC would be discharged into deep well injection and thus not be subjected to NPDES requirements (instead there would be less stringent WDRs to consider). For the SSD project, which is a collaboration with Carpinteria, the ROC would need to meet the Carpinteria NPDES permit for ocean discharge.
- **Regarding the AWPf:** WWTP effluent quality can impact the sizing and efficiency of advanced treatment, as shown in Table 2.7. For example, excess ammonia in the effluent can overwhelm the nitrification capacity of the BAC filters required in DPR treatment processes, causing it to become anaerobic due to the depletion of available oxygen. Ammonia levels of 1 to 3 milligrams per liter of nitrogen (mg/L-N) in the WWTP effluent are well managed by the BAC while levels of 4 to 5 mg/L-N are problematic and require diversion away from the DPR treatment process.

¹⁰ State Water Resources Control Board (SWRCB) (2019). California Ocean Plan, February 2019. https://www.waterboards.ca.gov/water_issues/programs/ocean/docs/oceanplan2019.pdf.

¹¹ SWRCB (2019). Water Quality Control Plan for the Central Coast Basin, June 2019. https://www.waterboards.ca.gov/centralcoast/publications_forms/publications/basin_plan/docs/2019_basin_plan_r3_complete_webaccess.pdf.

Table 2.7 Conceptual Review of WWTP Effluent Quality Impacts on Advanced Treatment

Parameters	Chemical Constituents	Impacts
Nutrients	Ammonia	High or variable effluent ammonia levels indicate an effluent that may have more biofouling or solids impacts to downstream advanced treatment.
	Nitrate ⁽¹⁾	Nitrate variation can be used to better understand changes in WWTP effluent quality.
	Nitrite	Existence of nitrite in the WWTP effluent indicates treatment inefficiency. Nitrite impacts ozone performance, for projects that require ozone treatment (such as DPR).
	Total Nitrogen	The State of California requires total nitrogen to be <10 mg/L after purification, lower in some cases. High total nitrogen may require more robust RO treatment.
Minerals and Other RO Scaling Constituents	Aluminum	High concentrations can scale RO membranes and impact RO design.
	Arsenic (III & V) ⁽¹⁾	
	Barium	
	Bicarbonate as HCO ₃	
	Calcium	
	Carbonate as CO ₃	
	Chloride	
	Chromium (VI) ⁽¹⁾	
	Ferric Iron ⁽¹⁾	
	Ferrous Iron ⁽¹⁾	
	Fluoride	
	Hardness	
	Magnesium ⁽¹⁾	
	Manganese	
	ortho-Phosphate	
	Phosphorus, Total	
	Potassium	
Silica		
Sodium		
Strontium		
Alkalinity, Total		
Hydrocarbons	O&G	O&G must be at low levels ahead of membrane treatment. Consistently measurable O&G requires pretreatment ahead of membrane treatment.
Salts	EC	High EC impacts RO design. EC value and variability is required to be determined.
	TDS ⁽¹⁾	High TDS (which correlates to high EC) require greater RO energy to overcome osmosis. High TDS also result in a more concentrated RO brine.

Parameters	Chemical Constituents	Impacts
Solids	TSS/Turbidity	High (or variable) TSS and turbidity directly impact membrane filtration performance. A filtered secondary effluent, for example, is more efficiently treated by membrane filtration than an unfiltered secondary effluent.
Other Chemicals	1,4-Dioxane	High levels of 1,4-dioxane require more robust final treatment due to their ability to pass through RO membranes.
	Boron ⁽¹⁾	Boron is one of the few chemicals that is not well treated by RO. High boron levels may require more robust RO treatment to meet Basin Plan Objectives.
	Bromate	Bromate is bromide by-products. High bromate concentration can scale RO membrane and impact RO design.
	Bromide	Bromide is potential for bromate formation by UV/AOP and can impact UV/AOP design.
	Free Chlorine	Free chlorine can impact MF chloramine chemistry.
	NDMA	High levels of NDMA require more robust final treatment due to their ability to pass through RO membranes.
	NMOR	NMOR is anticipated to be very low, but high NMOR will drive up UV cost.
	pH	pH needs adjustment ahead of RO. Ambient pH needed to inform design.
	Sulfate ⁽¹⁾	Sulfate is significant contributor to TDS, with higher TDS impacting RO system recovery and energy use.
	TOC	TOC is used as a surrogate for RO performance. High TOC values can increase membrane biofouling.

Notes:

(1) Central Coast Basin Plan Constituent.

CO₃ - carbonate; EC - electrical conductivity; HCO₃ - bicarbonate; MF - microfiltration; NDMA - N-Nitrosodimethylamine;

NMOR - N-Nitrosomorpholine; O&G - oil and grease; TSS - total suspended solids

The constituents listed in the above table are typically not sampled for conventional WWTP operation. For this planning level analysis, most of this information is assumed based upon similar projects. Table 2.8, below, indicates which data sets are available for each of the three utilities.

Table 2.8 List of Recorded Constituents From the Effluent Water Quality in Selected Three Utilities

Parameters	Chemical Constituents	Buellton	Solvang	SSD
Nutrients	Ammonia	X	X	X
	Nitrate	X	X	
	Nitrite	X	X	
	Total Nitrogen	X	X	
Minerals and Other RO Scaling Constituents	Aluminum			
	Arsenic (III & V)			
	Barium			
	Bicarbonate as HCO ₃			
	Calcium			
	Carbonate as CO ₃			
	Chloride	X	X	
	Chromium (VI)			
	Ferric Iron			
	Ferrous Iron			
	Fluoride			
	Hardness			
	Magnesium			
	Manganese			
	ortho-Phosphate			
	Phosphorus, Total			
	Potassium			
	Silica			
	Sodium	X	X	
	Strontium			
Alkalinity, Total				
Hydrocarbons	O&G			
Salts	EC			
	TDS	X	X	
Solids	TSS	X	X	X
	Turbidity			X
Other Chemicals	1,4-Dioxane			
	Boron	X	X	
	Bromate			
	Bromide			
	Free Chlorine			
	NDMA			
	NMOR			
	pH	X	X	
	Sulfate	X	X	
	TOC			

2.4.1.1 City of Solvang

The City of Solvang WWTP treats a maximum of 1.5 mgd maximum daily flow with a 1.13 mgd mean monthly flow. Solvang must comply with the effluent specific limitations listed in Table 2.9 in accordance with the Solvang WDR Permit No. R3-2022-0040.

Table 2.9 City of Solvang Effluent Limitations

Effluent Limitations	Constituent	Units	30-Day Average	7-Day Average	Sample Maximum ⁽¹⁾	25-Month Rolling Median	Sampling Frequency
Interim ⁽¹⁾ Standard WWTP Effluent Parameters	BOD ₅	mg/L	30	N/A	N/A	N/A	Monthly
	TSS	mg/L	30	N/A	N/A	N/A	Monthly
	Settleable Solids	mL/L	0.1	N/A	0.5	N/A	Weekly
	TDS	mg/L	1,000	N/A	1,400	N/A	Monthly
	Sodium	mg/L	150	N/A	250	N/A	Monthly
	Chloride	mg/L	150	N/A	250	N/A	Monthly
	pH	Standard Unit	6.5-8.4	N/A	N/A	N/A	Weekly
Future ⁽²⁾ Standard WWTP Effluent Parameters (Beginning July 2024)	BOD ₅	mg/L	30	45	N/A	N/A	Monthly
	TSS	mg/L	30	45	N/A	N/A	Monthly
	Settleable Solids	mL/L	0.1	0.3	0.5	N/A	Weekly
	pH	Standard Unit	6.5-8.4	N/A	N/A	N/A	Weekly
Based on Santa Ynez Basin Plan Objectives	TDS	mg/L	N/A	N/A	N/A	600	Monthly
	Sulfate	mg/L	N/A	N/A	N/A	10	Monthly
	Boron	mg/L	N/A	N/A	N/A	0.5	Monthly
	Total Nitrogen	mg/L	N/A	N/A	N/A	10	Monthly
	Chloride	mg/L	N/A	N/A	N/A	50	Monthly
	Sodium	mg/L	N/A	N/A	N/A	20	Monthly

Notes:

(1) Sample maximum for interim activated sludge indicates daily maximum.

(2) Interim effluent limitations apply for up to 24 months from June 2022.

BOD₅ - 5-day biochemical oxygen demand test; mL/L - milliliter per liter

Available water quality data from 2018 through 2022 for the City of Solvang is summarized in Table 2.10.

Table 2.10 City of Solvang Water Quality Data

Constituents	Units	Average	Minimum	Maximum	No. of Samples
Influent					
TDS	mg/L	1,052	540	1,700	60
Sodium	mg/L	186	93	280	48
Chloride	mg/L	243	140	500	48
Sulfate	mg/L	198	130	250	4
Boron	mg/L	N/A	N/A	N/A	0

Constituents	Units	Average	Minimum	Maximum	No. of Samples
Effluent					
TDS	mL/L	902	542	1,225	60
Sodium	mg/L	179	135	205	60
Chloride	mg/L	208	155	243	60
Sulfate	mg/L	221	140	278	5
Boron	mg/L	0.42	0.37	0.46	6
BOD ₅	mg/L	12.16	2.20	24.25	60
TSS	mg/L	1.25	~0	10.03	60
Suspended Solids	mg/L	0.01	~0	0.10	60
pH	Standard Unit	7.33	7.02	7.64	60
Total Nitrogen	mg/L	8.83	4.32	34.75	60
Ammonia	mg/L	4.51	0.20	33.50	60
Nitrate	mg/L	1.91	~0	11.08	60
Nitrite	mg/L	0.84	~0	22.78	60
TKN	mg/L	6.54	2.13	34.75	60

Notes:

TKN - total Kjeldahl nitrogen

2.4.1.2 City of Buellton

The City of Buellton WWTP treats a maximum of 0.65 mgd ADWF and 1.2 mgd peak hour wet weather flow. Buellton must comply with the effluent specific limitations listed in Table 2.11 in accordance with the Buellton WDR Permit No. R3-2020-0020.

Table 2.11 City of Buellton Effluent Limitations

Effluent Limitations	Constituent	Units	30-Day Average	7-Day Average	Sample Maximum	25-Month Rolling Median	Sampling Frequency
Standard WWTP Effluent Parameters	BOD ₅	mg/L	30	45	N/A	N/A	Monthly
	TSS	mg/L	30	45	N/A	N/A	Monthly
	Settleable Solids	mL/L	0.1	0.3	0.5	N/A	Weekly
	pH	Standard Unit	6.5–8.4	N/A	N/A	N/A	Weekly
Based on Santa Rita Basin Plan Objectives	TDS	mg/L	N/A	N/A	N/A	1,500	Monthly
	Sulfate	mg/L	N/A	N/A	N/A	700	Monthly
	Boron	mg/L	N/A	N/A	N/A	0.5	Monthly
	Total Nitrogen	mg/L	N/A	N/A	N/A	10	Monthly
Based on Designated Santa Rita Groundwater Basin	Chloride	mg/L	N/A	N/A	N/A	150	Monthly
	Sodium	mg/L	N/A	N/A	N/A	100	Monthly

Available effluent water quality data from 2018 through 2022 for the City of Buellton is summarized in Table 2.12.

Table 2.12 City of Buellton Water Quality Data

Constituents	Units	Average	Minimum	Maximum	No. of Samples
TDS	mg/L	1,017	770	1,300	25
Sodium	mg/L	207	180	230	18
Chloride	mg/L	215	190	230	18
Settleable Solids	mL/L	0	0	3	53
Sulfate ⁽¹⁾	mg/L	240	210	310	7
Boron ⁽¹⁾	mg/L	0	0	1	7
BOD ₅	mg/L	9	0	29	19
TSS	mg/L	7	0	24	18
pH	Standard Units	7	7	8	17
Total Nitrogen ⁽²⁾	mg/L	10	1	38	28
Ammonia ^(1,2)	mg/L	15	0	30	6
Nitrate	mg/L	2	0	7	17
Nitrite ⁽¹⁾	mg/L	0	0	0	7
TKN ⁽¹⁾	mg/L	14	1	31	7

Notes:

- (1) Data was based on 2022 only.
- (2) Per input from Buellton plant staff, the Buellton WWTP consistently nitrifies and denitrifies. Total nitrogen is typically <4 mg/L and ammonia is near non-detect. The high values seen in these datapoints were due to limited sampling as well as some failed components that have since been repaired.

2.4.1.3 Summerland Sanitary District

SSD discharges to the Pacific Ocean under an existing NPDES permit. That permit is not relevant to this analysis. For this project, the SSD would transfer their raw wastewater to the CSD for treatment at the CSD WWTP and later purification as part of CAPP. Available water quality data from 2018 through 2022 for SSD is summarized in Table 2.13.

Table 2.13 Summerland Sanitary District Water Quality Data

Constituents	Units	Average	Minimum	Maximum	No. of Samples
Influent ⁽¹⁾					
TSS	mg/L	425	55	1,690	62
TSS	ppd	298	33	1,712	62
BOD ₅	mg/L	296	89	797	62
BOD ₅	ppd	210	1	740	62
Effluent					
Turbidity	NTU	0.90	0.07	4.55	60
TSS	mg/L	2.16	0.88	8.15	60
TSS	ppd	1.61	0.50	5.71	60
TSS Removal	%	98	50	100	60
Ammonia	mg/L	0.04	0.01	0.15	35

Constituents	Units	Average	Minimum	Maximum	No. of Samples
BOD ₅	mg/L	4.35	2.10	8.33	60
BOD ₅	ppd	3.11	1.08	6.93	60

Notes:

(1) Influent water quality data was calculated during January 2018 and Feb 2023.

% - percent; NTU - nephelometric turbidity unit; ppd - pounds per day

2.4.2 Effluent Water Quantity Data

Efficient advanced treatment requires an equalized flow. Such EQ also results in maximum water capture and recovery as a new potable water supply. The sections below review the wastewater flows for the selected utilities and include new EQ sizing where needed.

2.4.2.1 City of Solvang

The AWPf will be sized to treat the entirety of the effluent wastewater from the Solvang WWTP. As noted previously, Solvang is working with the RWQCB to determine appropriate concentrate-based discharge limits for a number of parameters/constituents. Proposed limits for some of these constituents cannot be met without RO treatment, included in the AWPf treatment train. Therefore, this PRW project was developed under the conservative assumption that all wastewater effluent would need to be captured for treatment. It is important to note that the AWPf will not always be fully utilized. Rather, a fraction of the treatment trains will be operated daily to meet ADWF requirements, while additional train(s) will be sized to handle any flow rates above the ADWF threshold. Therefore, the sizing of the facility must consider both the ADWF and the peak hourly flow rates to maximum operational efficiency and effectiveness. If permitting negotiations are successful, and RO is not required and/or if PWWF does not require RO treatment, then the large EQ basin could be removed from the project and the size of the Solvang AWPf could also decrease.

An examination of the mean influent flow data has been conducted for the period spanning from January 2018 through December 2022, with the average, minimum, and maximum influent flow shown in Table 2.14. A graphical representation of the monthly average flow rates and accumulated monthly precipitation is depicted in Figure 2.3. Through analysis of the flow data for the four consecutive months of April through July in 2020, when minimal rainfall is observed, the ADWF has been calculated to be 0.59 mgd.

Table 2.14 City of Solvang Influent Flow Summary

Constituents	Units	Average	Average Dry Weather	Minimum	Maximum	No. of Samples
Flow	mgd	0.63	0.59	0.55	0.78	60

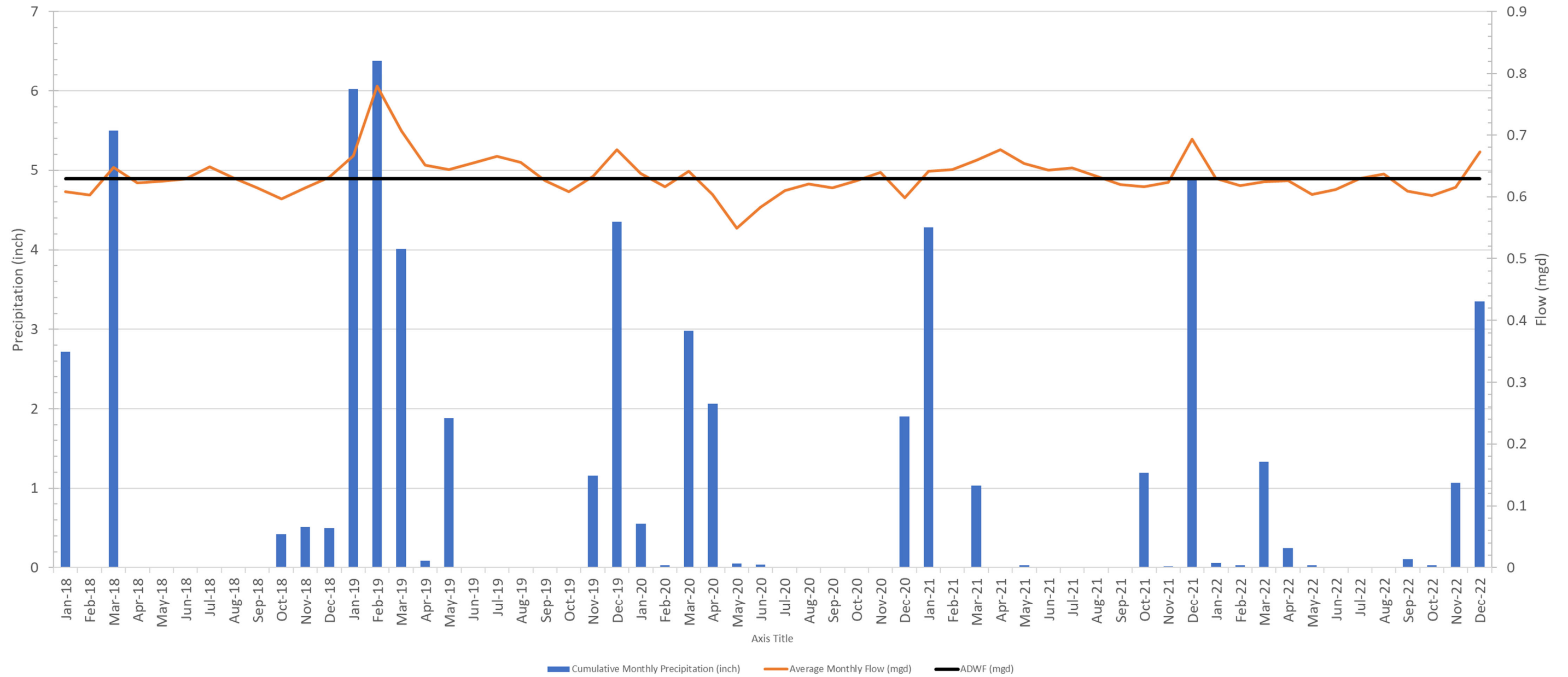

Figure 2.3 City of Solvang Average Monthly Flow and Cumulative Monthly Precipitation During 2018 and 2022.

A more detailed analysis of one year of hourly secondary effluent flow data was conducted, with the data spanning from May 1, 2022, to May 1, 2023. This data was evaluated to determine peak wet weather EQ requirements and available dry weather flow for potable reuse. Three diurnal flow curves are shown in Figure 2.4 and key aspects of that data include:

- **The average hourly diurnal flow curve:** The average hourly diurnal flow curve has been computed by taking the average of the hourly flow rate dataset between hour 0 and hour 23 over the entire year.
- **The peak wet weather hourly diurnal flow curve (January 9, 2023):** The peak wet weather hourly diurnal flow curve has been selected from the day when the highest hourly flow rate was recorded.
- **The minimum dry weather hourly diurnal flow curve (September 25, 2022):** The minimum dry weather hourly diurnal flow curve has been chosen from the day when the lowest hourly flow rate was observed. Based upon the analyzed data, the ADWF has been set at 0.59 mgd.

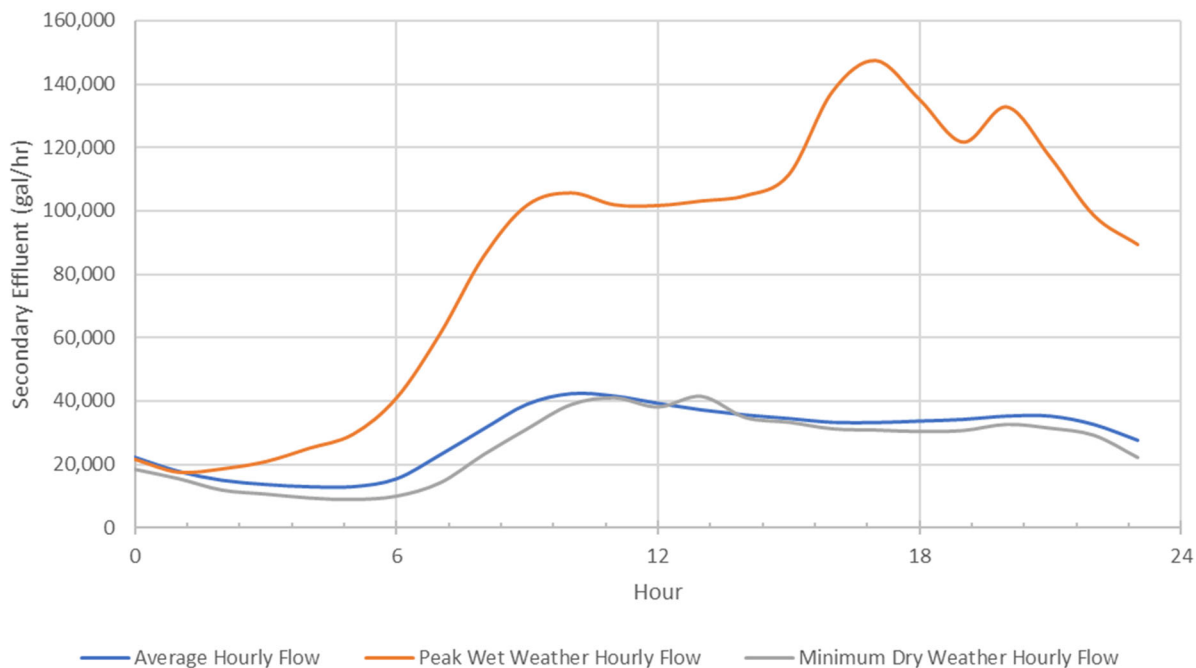

Figure 2.4 City of Solvang Hourly Diurnal Flow Curve Between May 1, 2022, and May 1, 2023

To equalize the ADWF, an EQ tank has been sized at a minimum of 510,000 gallons. However, as noted previously, the goal for Solvang is to equalize and treat 100 percent of the flow. As such, a larger EQ basin is needed. Through analysis of the PWWF from 2023, Carollo set different sizes of EQ basins based upon the capacity of the AWWPF (e.g., smaller EQ requires a larger AWWPF), as shown in Table 2.15 below. While EQ of ADWF requires a relatively small basin (510,000 gallons), EQ of PWWF either requires a large volume of EQ (up to 5.8 MG) or large AWWPF (up to 1.8 mgd in this example).

The EQ tank was suggested to be 4.3 MG to meet a 1.0 mgd AWWPF treatment capacity. The equalized flow would be treated at its own AWWPF with the AWWPF treatment capacity up to 1.0 mgd as Scenario 1, or distributed to Buellton to be treated at the combined AWWPF as Scenario 2. If the treated wastewater distributed from Solvang was equal to or below the designed ADWF (0.59 mgd), the water would be blended in Buellton’s piping system before the distribution to the AWWPF. If the treated wastewater

distributed from Solvang was higher than the ADWF up to 1.0 mgd in storm events, on the other hand, the water would be distributed directly to the AWPf at Buellton while the treated wastewater from Buellton would be discharged into land application.

To ensure a treatment capacity of 1.0 million mgd for the AWPf, it was recommended that the EQ tank have a capacity of 4.3 MG. Under Scenario 1, the equalized flow would be treated exclusively at its dedicated AWPf with a capacity of up to 1.0 mgd. Alternatively, under Scenario 2, the equalized flow would be routed to Buellton for treatment at the combined AWPf.

In the event that the treated wastewater being distributed from Solvang is equal to or below the designed ADWF of 0.59 mgd, the water would be mixed within Buellton's piping system before being distributed to the AWPf. Conversely, if the treated wastewater from Solvang exceeds the ADWF to 1.0 mgd during storm events, the water would be directly distributed to the AWPf at Buellton, while the treated wastewater from Buellton would be discharged into its land application without advanced treatment.

As noted, if RWQCB permitting negotiations are successful, the size of the required EQ basin at the Solvang plant could shrink significantly in both Scenarios 1 and 2 if PWWF EQ is no longer required.

Table 2.15 Minimum Equalization Storage Required for Increased AWPf Treatment Capacity

AWPF Treatment Capacity (mgd)	Minimum Equalization Storage Required for PWWF (gallons)
0.6	5,800,000
0.9	4,700,000
1.0	4,300,000
1.2	3,600,000
1.8	1,300,000

2.4.2.2 City of Buellton

The AWPf will be designed to treat the ADWF based on historical data, with any additional flow rates above the ADWF threshold being discharged to the adjacent percolation ponds.

A study has been carried out to analyze the average influent flow data for the duration ranging from January 2018 to December 2022 with an influent summary in Table 2.16. The mean monthly flow rates are provided in Figure 2.5. In accordance with Solvang's flow analysis, the ADWF has been determined to be 0.43 mgd by examining the flow data for the months spanning from February to May in 2020 with the minimum monthly flow observed.

A more detailed analysis of one year of hourly flow data was conducted, with the data between April 24, 2022, and April 30, 2023. This data was evaluated to determine peak wet weather EQ requirements and available dry weather flow for potable reuse. Figure 2.6 shows the average hourly diurnal flow curve, the peak wet weather hourly diurnal flow curve (January 10, 2023), and the minimum dry weather hourly diurnal flow curve (July 28, 2022). Based on the analyzed data, for the initial design, the ADWF has been set at 0.43 mgd.

Table 2.16 City of Buellton Influent Flow Summary

Constituents	Units	Average	Average Dry Weather	Minimum	Maximum	No. of Samples
Influent Flow	mgd	0.46	0.43	0.41	0.63	60

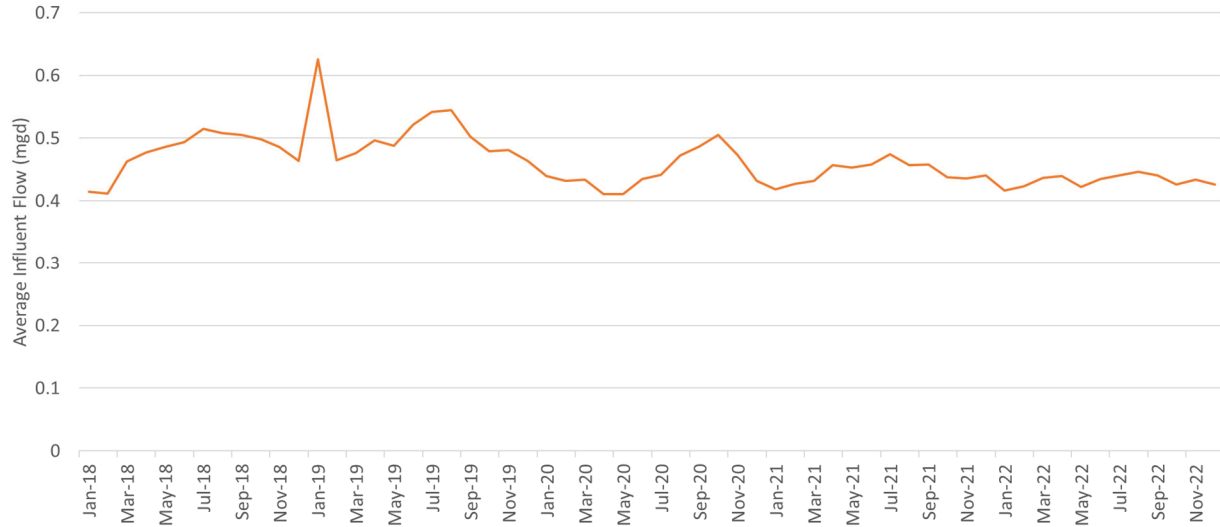

Figure 2.5 City of Buellton Average Monthly Flow During 2018 and 2022

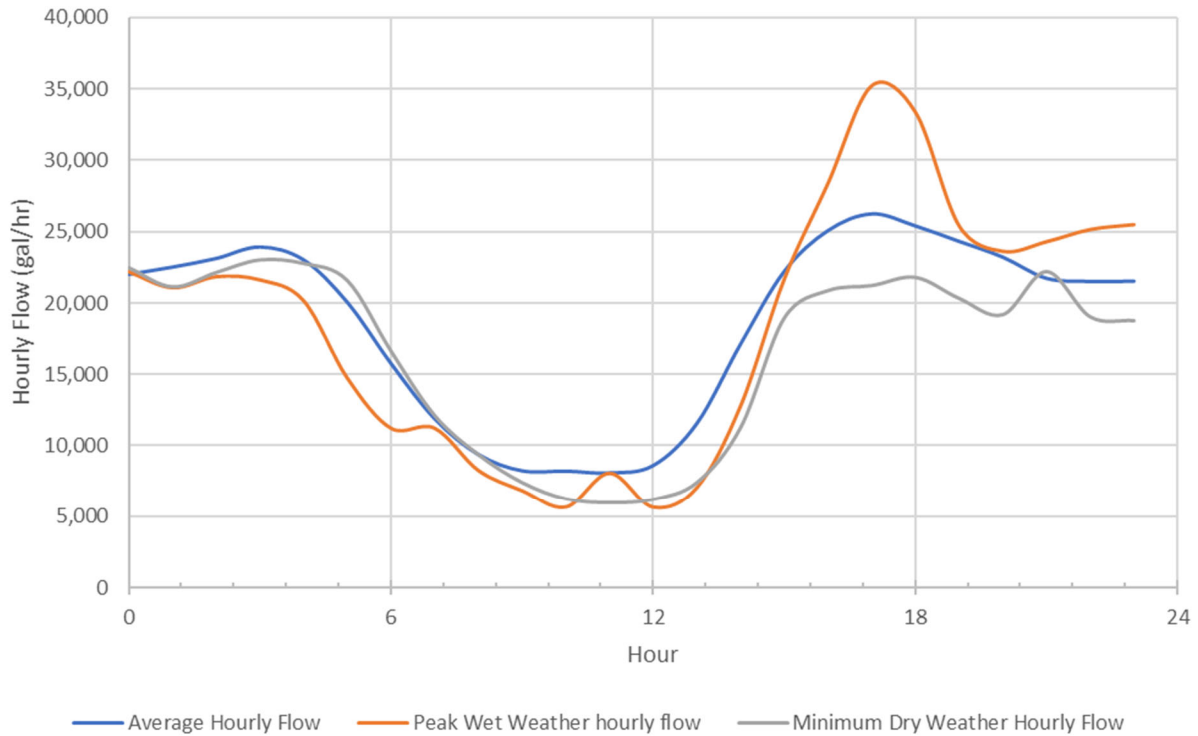

Figure 2.6 City of Buellton Hourly Diurnal Flow Curve Between April 24, 2022, and April 30, 2023

As previously mentioned, the AWPf will be sized to treat the ADWF and any surplus flow rates beyond the ADWF threshold will be discharged to the adjoining percolation ponds. Thus, an EQ tank with a minimum capacity of 140,000 gallons has been sized to balance the ADWF.

2.4.2.3 Summerland Sanitary District

For this project, all untreated¹² wastewater from SSD will be redirected to CSD for wastewater treatment and subsequent advanced treatment. Accordingly, there are two important pieces of information related to flow:

1. The SSD ADWF determines how much additional water can be purified on a daily basis for groundwater recharge as a part of the planned CSD CAPP.
2. The SSD PWWF determines how much EQ is needed prior to connecting into the CSD sewer system. Greater EQ results in reduced flow rates into the CSD system, so there are a range of combinations of EQ and pumping rates to CSD.

An analysis of average daily flow from January 2018 to April 2023 has been conducted to determine the ADWF values for SSD. Within the context of Figure 2.7 and Figure 2.8, three outliers are observed, including the flow rate of 1.27 mgd observed on September 10, 2018, and the flow rates of 0.8 mgd and 0.82 mgd on February 3, 2023, and February 4, 2023, respectively, and thus assumed to be an erroneous recording (there is no high flow before or after these days) and subsequently have been removed from the ADWF calculations. The updated and corrected average daily flow data is presented in Figure 2.9. The ADWF value to be used to supplement the advanced treatment system for potable reuse in the CSD CAPP project was calculated by assessing the minimum average flow of four consecutive months over the entire dataset. The minimum over this timeframe was found to be 0.062 mgd, which was the average between August and November in 2020 and thus is the assumed ADWF.

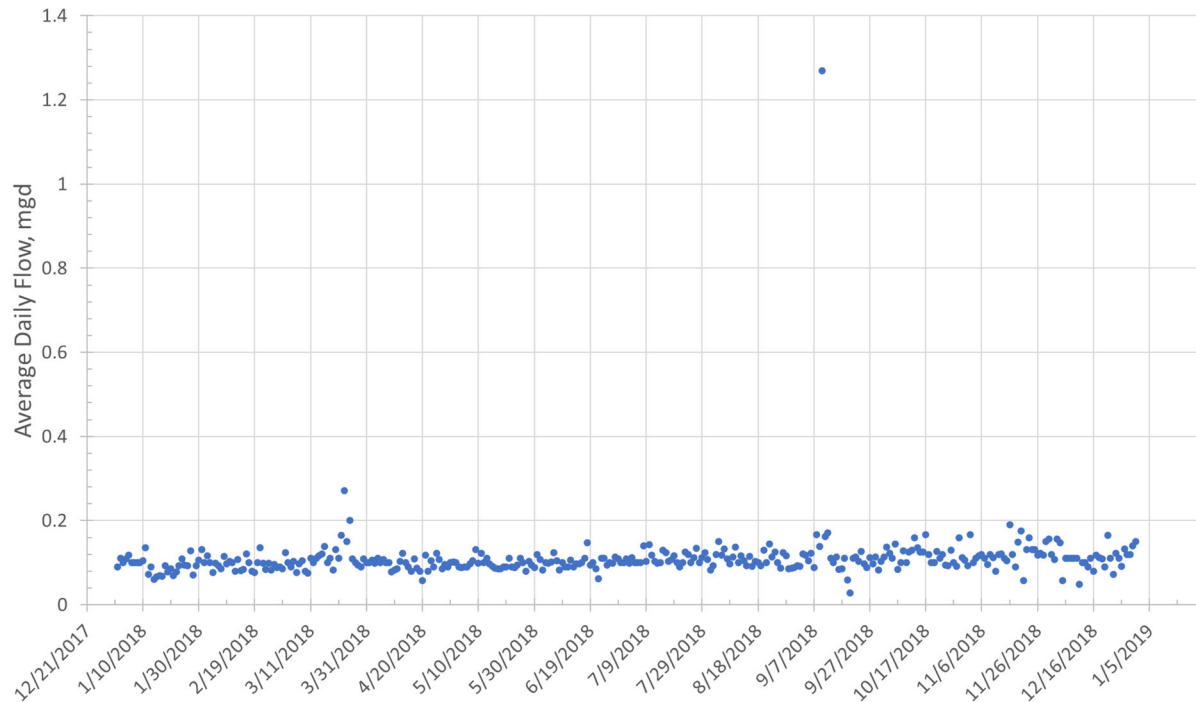

Figure 2.7 Average Daily Flow in 2018, Outlier Included

¹² SSD wastewater is anticipated to be screened ahead of EQ, but no primary or secondary treatment will be employed before transferring the wastewater to CSD.

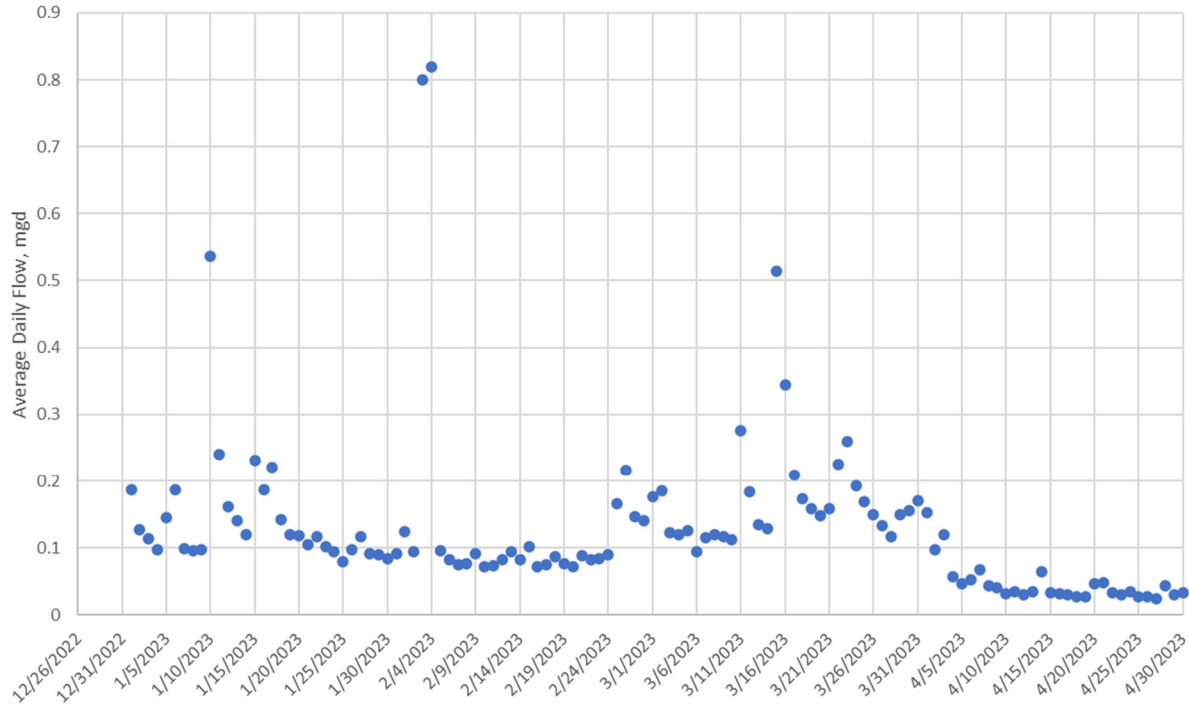

Figure 2.8 Average Daily Flow in 2023, Outliers Included

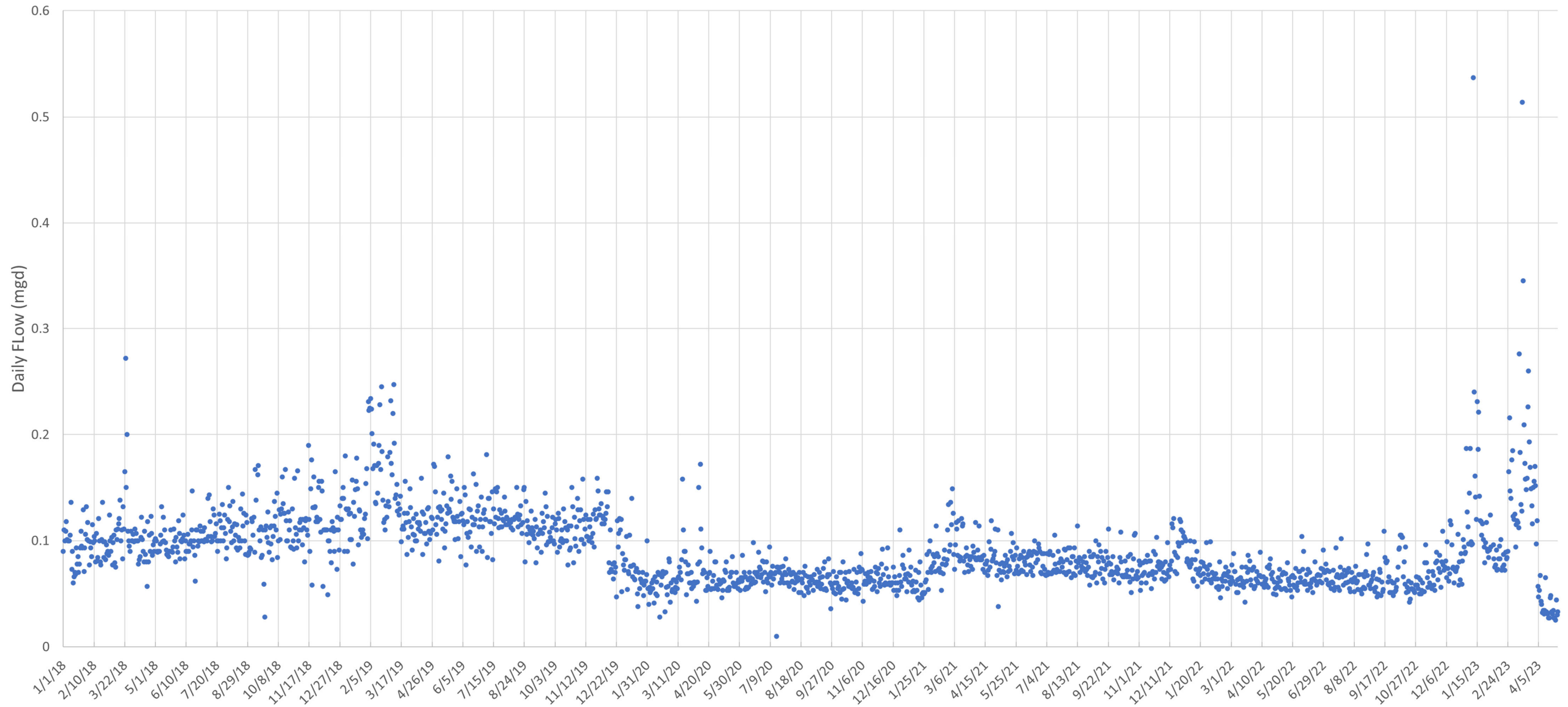

Figure 2.9 Summerland Sanitary District Daily Flow Between January 2018 and April 2023, Outliers Removed

Two flow scenarios below were evaluated to discuss the EQ sizing and corresponding pumping rates to transfer untreated wastewater to CSD:

- **Scenario 1:** Daily Flow Totals During 2023 Wet Weather Period.
- **Scenario 2:** Extended Wet Weather Simulation.

Scenario 1: Daily Flow Totals During 2023 Wet Weather Period

In this scenario, the daily PWWF dictates EQ and pumping rates into the CSD sewer collection system. The same four years of average daily flow data were examined for storm events and the highest average daily flow was observed in 2023. Based on the 2023 average daily flow data, five distinct pumping rates were selected to transport untreated wastewater from the EQ tank(s) in SSD to the CSD sewer collection system. Table 2.17 indicates the minimum required storage for each pumping rate. Figure 2.10 depicts the water accumulation of EQ storage for each pumping rate. In order to utilize the existing EQ tank (70,000-gallon total capacity) at SSD, the minimum effluent pumping rate of raw wastewater to the CSD sewer collection system will be 0.47 mgd.

Table 2.17 Minimum Required Equalization Storage to CSD Sewer Collection System Under Scenario 1

Parameter	Raw Wastewater to CSD Sewer Collection System (mgd)			
	0.1	0.15	0.2	0.47
Minimum Required EQ Storage (gallons)	3,478,000	1,025,000	468,000	67,000

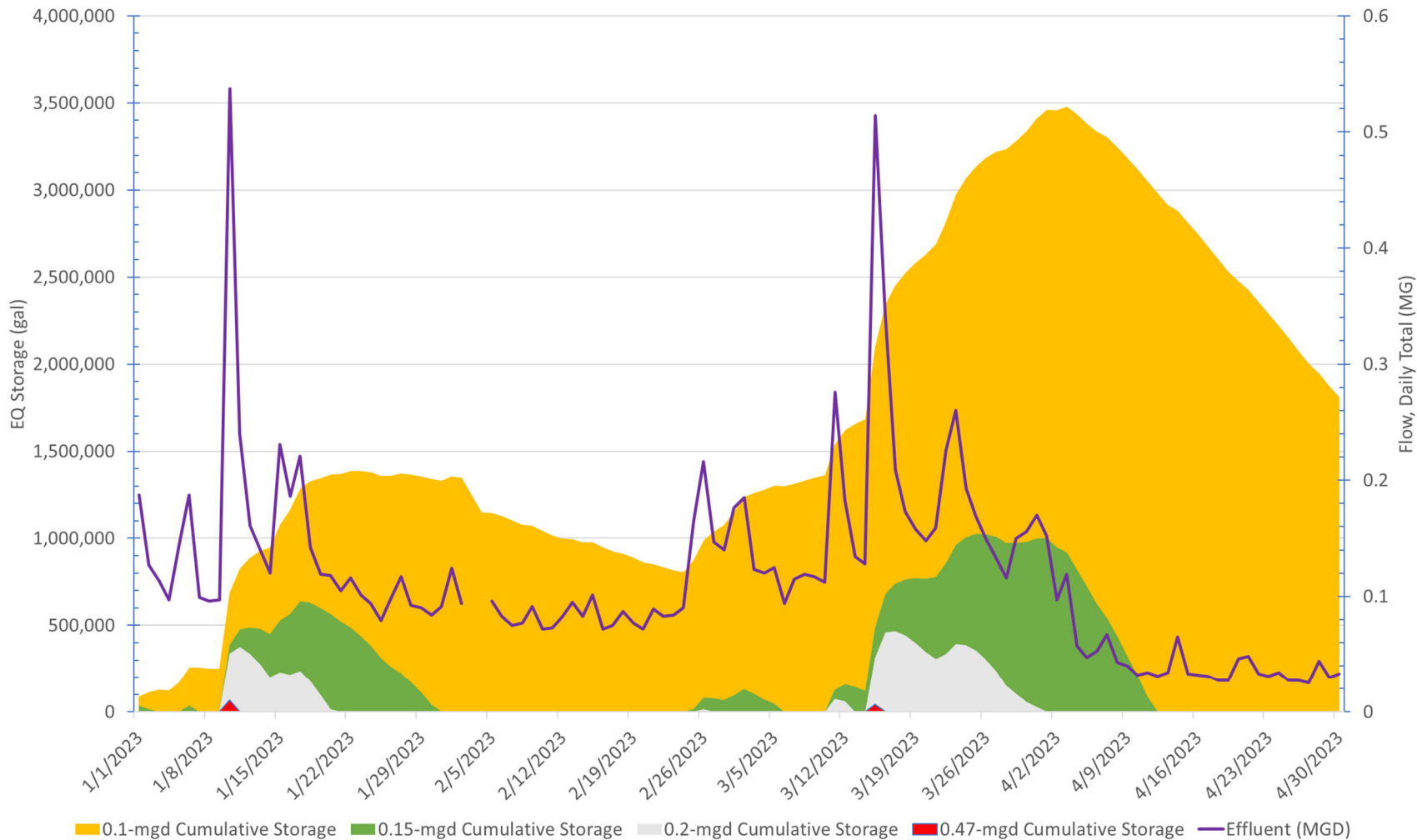

Figure 2.10 Cumulative Storage of Equalization Tank(s) in Summerland Sanitary District for Each Constant Pumping Rate to the CSD Sewer Collection System in 2023

Scenario 2: Extended Wet Weather Simulation

An extended analysis was conducted at SSD using historical hourly flow data from 2023, examining a single continuous week characterized by the most severe wet weather event. Among the observed days, five exhibited the highest daily flow totals for the entire year. Figure 2.11 illustrates the hourly diurnal flow curves for these days. Notably, January 10, 2023, marked the PWWF, reaching a total daily flow of 0.54 MG. Consequently, this day was chosen to simulate a continuous and repetitive week of hourly flows, allowing for an accurate sizing of the EQ tank(s) in the worst storm event scenario.

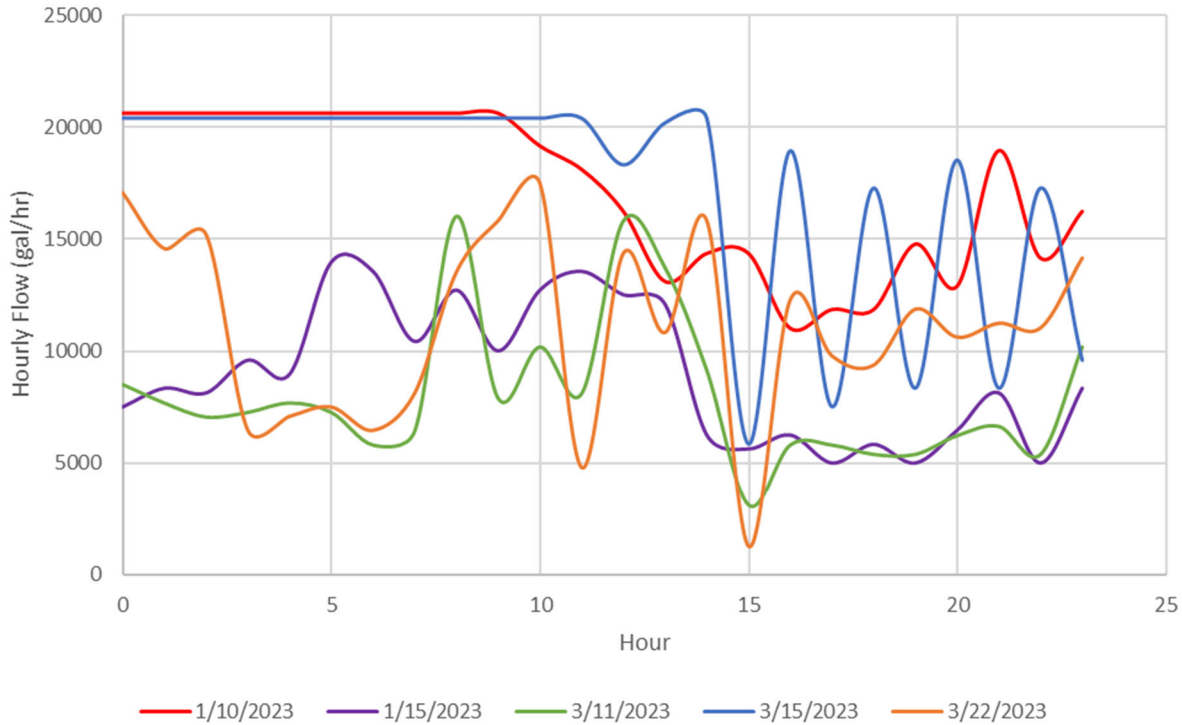

Figure 2.11 Summerland Sanitary District Hourly Diurnal Flow Curves for Five Wet Weather Days During 2023

Six distinct pumping rates were selected to transport untreated wastewater from the EQ tank(s) in SSD to the CSD Sewer Collection System, some of which were selected to compare the sizes of EQ tank(s) with Scenario 1. Table 2.18 indicates the minimum required storage for each pumping rate. Figure 2.12 depicts the water accumulation of EQ storage for each pumping rate. If the EQ effluent pumping rate is 0.3 mgd, the raw wastewater from SSD will not be significantly accumulated in the EQ tank(s) and the minimum required EQ storage will be around 0.8 MG. Furthermore, when the EQ effluent pumping rate is raised by 0.07 mgd to align with Scenario 1, where the current 70,000-gallon EQ tank is repurposed, the minimum EQ storage capacity needed would be 11,000 gallons. This value is considerably lower than the existing EQ tank's capacity of 70,000 gallons.

Table 2.18 Minimum Required Equalization Storage to CSD Sewer Collection System Under Scenario 2

Parameter	Raw Wastewater to CSD Sewer Collection System (mgd)					
	0.1	0.15	0.2	0.3	0.4	0.47
Minimum Required EQ Storage (gallons)	2,195,000	1,845,000	1,495,000	795,000	125,000	11,000

SSD Flow Scenario Summary

The equalized flow from SSD will be distributed to CSD for wastewater treatment and subsequent advanced treatment. For the purposes of this study, the EQ sizing developed in Scenario 1 will be used for infrastructure analysis, discussed in Chapter 5. It is important to note that should this study proceed forward, further flow monitoring is required. For example, the highest flow observed from the data (noted in Scenario 2) was approximately 0.54 mgd during the 2023 winter storm events. However, based on SSD staff input, visual observations of instantaneous peaks as high as 0.6 mgd were observed, exceeding this noted 0.54 mgd.

In addition to flow monitoring, it is crucial to verify the availability of capacity at the CSD WWTP to handle the flow from SSD. A previous study was conducted to estimate the available additional WWTP capacity at CSD.¹³ Summary points from that project indicate:

- The rated capacity of the CSD WWTP is 2.5 mgd.
- Hourly influent sewer flows to CSD varied between 0.14 and 2.72 mgd from December 2020 to December 2021.
- The majority of time, even during wet weather, the CSD WWTP has more than 0.5 mgd of available capacity.
- For 99 percent of the hours during the period, CSD could manage an additional 0.72 mgd of flow and stay at or below 2.5 mgd of total flow.
- The addition of an equalized flow from SSD, in the range of 0.2 mgd, and potentially higher, appears feasible for the CSD WWTP, noting that confirmation of such available capacity and willingness to accept the flow must be obtained from CSD. Further discussion on this is available in Chapter 5.

¹³Carollo and Water Systems Consulting, Inc., January 2023, Technical Memorandum 2: CSD and Santa Barbara WRP Capacity, developed for the MSD and MWD Enhanced Recycled Water Feasibility Analysis.

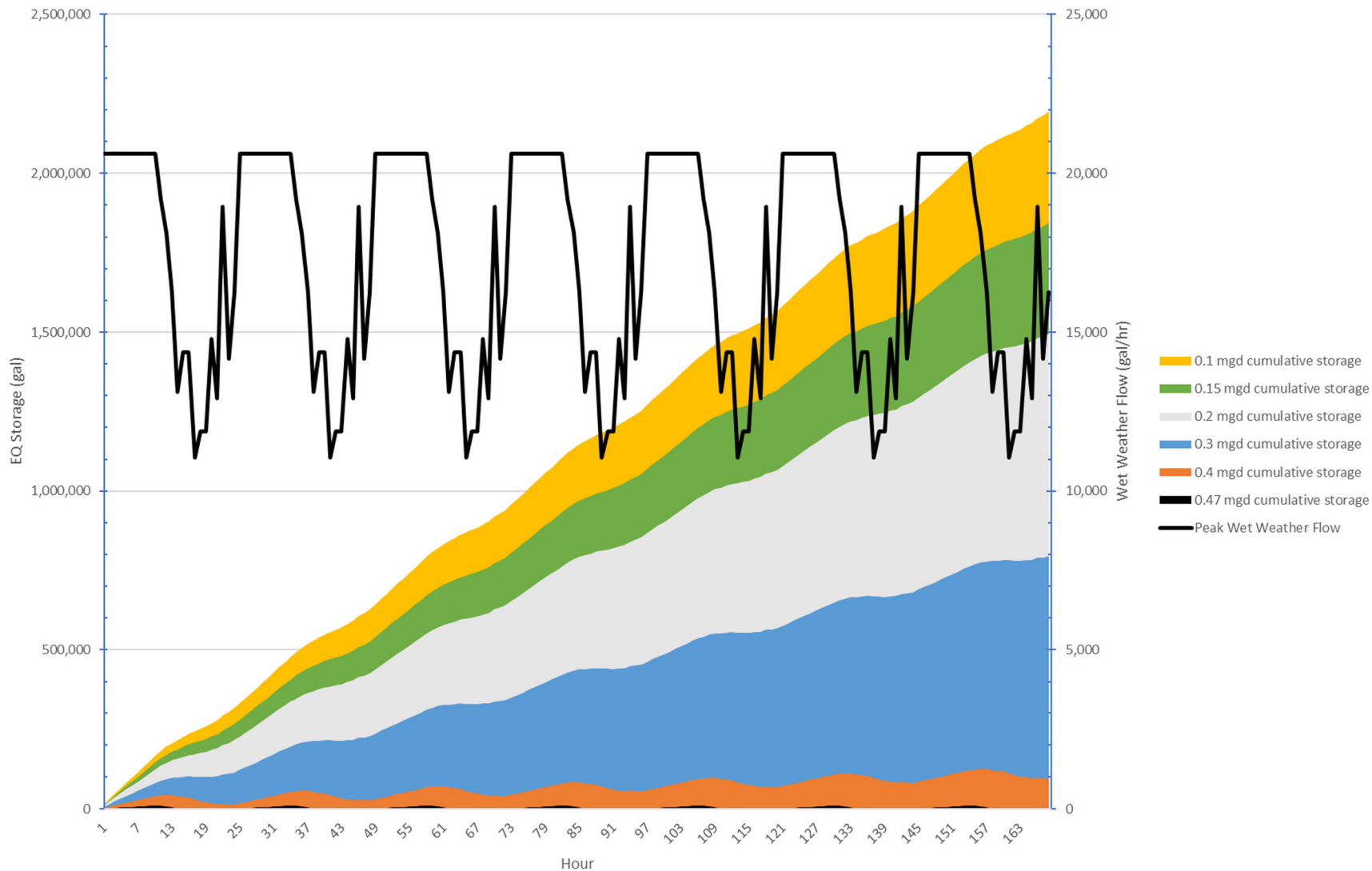

Figure 2.12 Cumulative Storage of Equalization Tank(s) in Summerland Sanitary District for Each Constant Pumping Rate to the CSD Sewer Collection System in One Continuous Week Based Upon the Peak Wet Weather Flow in 2023

CHAPTER 3 REGULATORY SUMMARY

3.1 Introduction

This chapter provides an overview of the State of California regulatory requirements for IPR projects and anticipated requirements for DPR. This chapter also highlights a number of key challenges that must be overcome for successful IPR and DPR implementation.

3.2 Regulatory Background and Context

Water recycling and potable reuse in California falls under the jurisdiction of the SWRCB. Within the SWRCB, two departments are responsible for protecting the public health and environment with respect to water: (1) the DDW; and (2) the RWQCBs. The DDW regulates public drinking water systems and is responsible for developing regulations for recycled water and for reviewing recycled water projects. The RWQCBs, which are divided into regions across the state, develop and enforce water quality objectives and implementation plans to protect the beneficial uses of the state's water, and write the permits for recycled water projects. The applicable RWQCB for this project is the Central Coast RWQCB.

The first type of IPR is GWR, which has been practiced successfully in California since the 1970s. Final regulations have been in place for GWR since 2014 (SWRCB, 2018), although they existed in draft form prior to that for almost 40 years. GWR can take two forms—surface spreading, which entails percolating nitrified tertiary effluent through spreading basins, and direct injection, which entails injecting advanced treated water directly into an aquifer. This study focuses only on GWR via direct injection; a schematic for this type of reuse is shown on Figure 3.1.

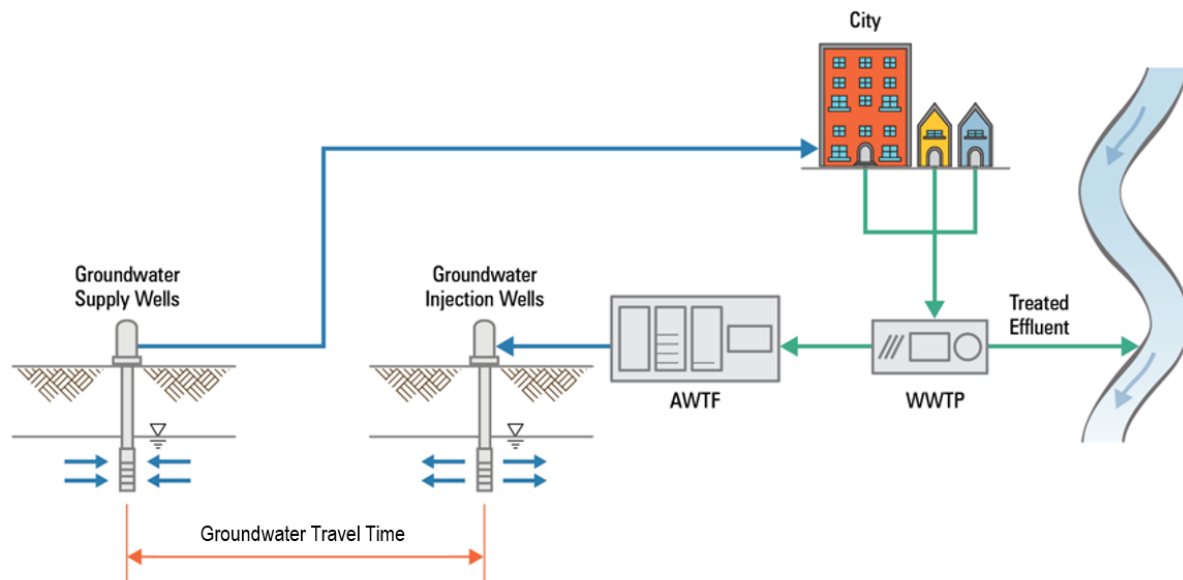

Figure 3.1 Schematic of IPR via GWR

The other type of IPR is SWA, regulations for SWA were finalized in 2018. SWA entails augmenting an existing drinking water reservoir with purified water, and later treating that water at a WTP prior to serving it to customers. Regulatory considerations for SWA consider many of the same elements as GWR, but also include new requirements to account for the lack of experience with this type of project and the complexities introduced by the use of a surface water reservoir. A schematic for SWA is shown in Figure 3.2. Nevertheless, SWA is not considered as a part of this study and will be discussed in Chapter 5 in detail.

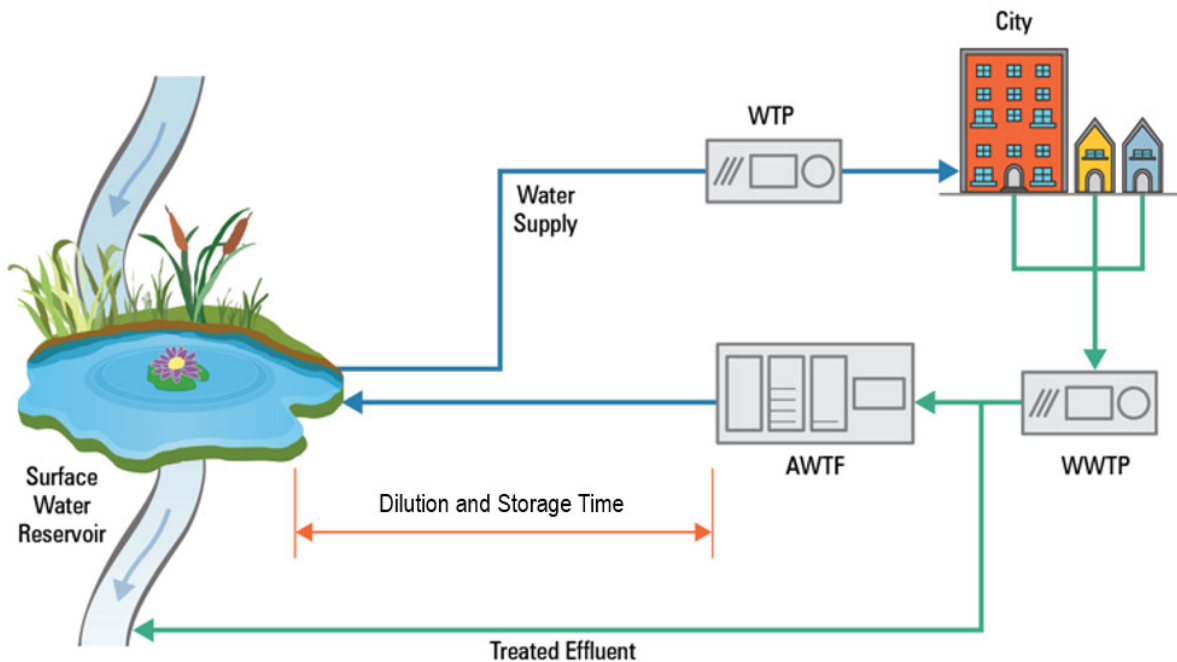

Figure 3.2 Schematic of IPR via SWA

DPR can take two forms—RWA, where purified water is placed ahead of a drinking WTP, and TWA, where purified water is put directly into the potable water distribution system. Schematics for RWA and TWA are shown on Figure 3.3 and Figure 3.4. However, RWA is not applicable as a part of this study.

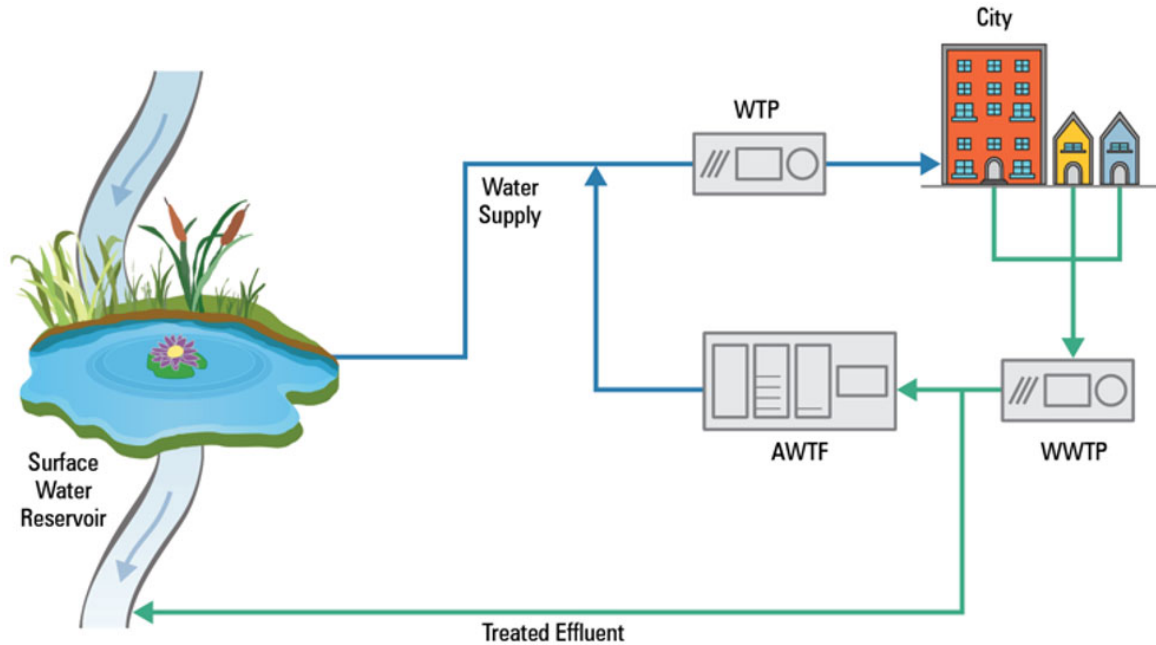

Figure 3.3 Schematic of DPR via RWA

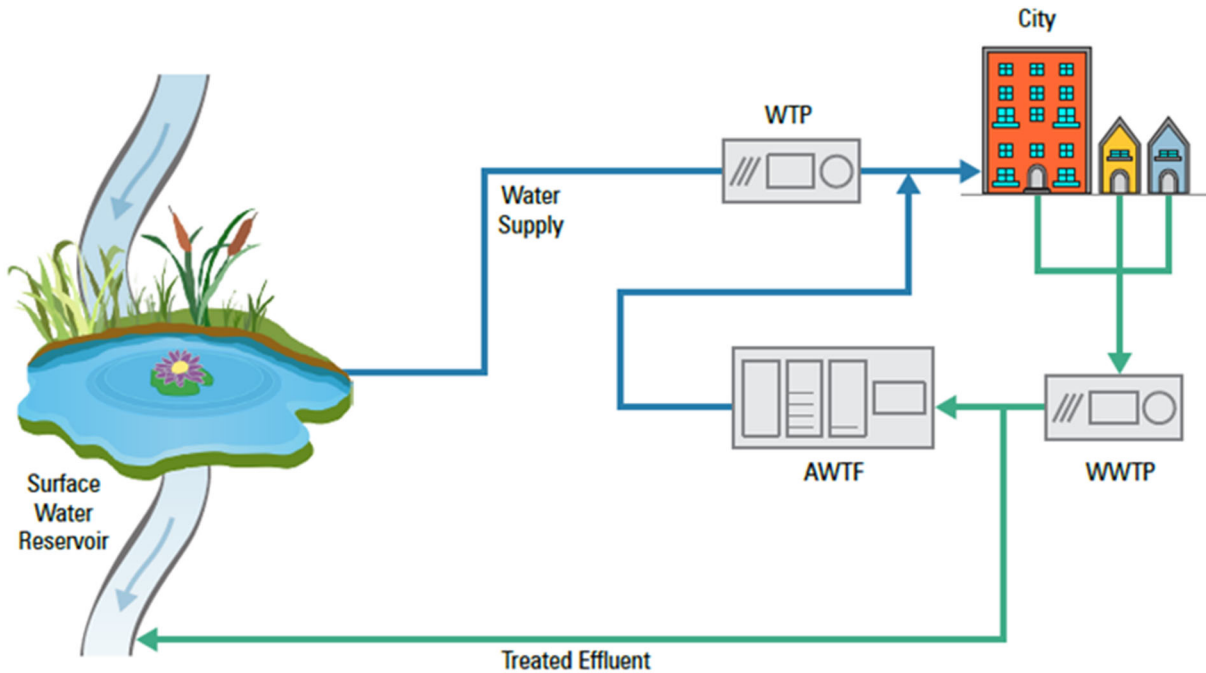

Figure 3.4 Schematic of DPR via TWA

There is currently one municipal scale operating DPR system in the country in Big Spring, Texas, which has been in operation since 2014. The Big Spring facility sends purified water into a raw water supply ahead of a WTP (i.e., RWA). There is one other DPR project in development in the US, namely the El Paso TWA

project, which has procured a contractor and will break ground in 2024. There are currently no operating DPR systems in California, although several agencies, including Metropolitan Water District and the City of Los Angeles, are in the midst of DPR project planning. Currently both agencies are pilot testing treatment technologies and developing long-term plans for combined IPR/DPR projects. At this point, given the novelty of DPR in California, any DPR project proposed will be on the leading edge and need to work closely with DDW.

The anticipated requirements for DPR are laid out in the latest draft regulations (issued August 2021), expert panel comments and responses (issued June 2022), and requested changes from WateReuse California to the DDW (dated February 13, 2023). This series of documentation allows for perspective and expert input on the anticipated treatment needs for DPR compared to IPR projects. The DPR regulations build on the public health protection requirements from IPR and incorporate:

- New elements to account for the loss of an environmental buffer (e.g., a groundwater basin or surface water reservoir).
- New information on pathogen concentrations.
- Safety factors for unknown or undetected chemical constituents.

In general, the DDW and RWQCBs work together to protect drinking water quality, public health, and the quality of surface and groundwater and are essential in authoring IPR and DPR projects.

3.3 Reuse Project Types

As described above, there are four main pathways to potable reuse in California: GWR, SWA, RWA, and TWA. All four pathways for potable reuse were initially considered for this project, and the appropriate reuse pathways were identified for each location.

The SSD will be considering GWR only, as the SSD project analysis will focus on diversion of all SSD raw wastewater into the CSD collection system to provide water to the planned CAPP project.

For the Solvang and Buellton projects, the absence of nearby reservoirs within the vicinity of the two cities makes the implementation of SWA impractical for the discharge of treated water in the context of IPR. Furthermore, the lack of WTPs in the vicinity of Solvang and Buellton makes it infeasible to pursue RWA. Hence, for the Solvang and Buellton projects, GWR for IPR or TWA for DPR would both be viable options to consider.

The reuse pathways being considered for each project location are summarized in Table 3.1.

Table 3.1 Reuse Pathways Under Consideration for Each Project Location

Project Location	Reuse Types Considered
SSD	IPR via GWR
Solvang	IPR via GWR; DPR via TWA
Buellton	IPR via GWR; DPR via TWA
Solvang-Buellton Combined	IPR via GWR; DPR via TWA

3.4 Potable Reuse Regulatory Summary

3.4.1 Project Structure and Interagency Coordination

Both IPR and DPR will require the participation of both water and wastewater agencies. Nevertheless, because DPR projects produce drinking water, the regulations define the DiPRRA as a public water agency that is responsible for using municipal wastewater for treatment and provides DPR project water, in this case directly for distribution. The DiPRRA could be a single agency or a multi-agency joint powers authority. The DiPRRA could also be a private water company. The DiPRRA concept does not apply to IPR projects, because IPR water is not “potable water” until it is extracted from the groundwater or withdrawn and treated from a surface water. Accordingly, the responsible agency for water supply is already addressed for IPR based upon existing regulations for municipal water supplies in California.

The DiPRRA must prepare a Joint Plan describing all agencies involved in the DPR project, their roles and responsibilities, and procedures to implement the requirements of the DPR regulations. The plan must also describe procedures for corrective actions that may be taken in the event of a failure to meet the requirements, procedures for public notifications, and provisions for backup supply in the event that purified water is not available. If required by the SWRCB, a DiPRRA must utilize an Independent Advisory Panel (IAP) to conduct reviews of various project elements, including the SCP, Water Safety Plans, and water quality data.

Of note, the DiPRRA need not be the entity that operates/maintains the wastewater SCP, WWTP, and advanced treatment facilities, though it is responsible for the overall program management and control as well as final water quality.

3.4.2 Source Control

Both IPR and DPR projects are required to use source control to limit the extent of contaminants entering the wastewater system. The requirements for DPR source control are more extensive than what is required for IPR projects and include several complex elements such as online sewer monitoring and coordination with public health surveillance programs. A comparison of the requirements for each reuse project type is presented in Table 3.2.

Table 3.2 Comparison of Source Control Requirements for IPR - GWR and DPR - TWA

	IPR - GWR	DPR - TWA
Source Control	<ul style="list-style-type: none"> ▪ Requires industrial pretreatment and pollutant SCP including: <ul style="list-style-type: none"> » Assessment of the fate of site-specific chemicals through the wastewater and recycled water treatment systems. » Monitoring and investigation of chemical sources. » Outreach program to minimize discharge of chemicals into the feedwater. 	<ul style="list-style-type: none"> ▪ Requires SCP. ▪ All elements of source control as needed for IPR. ▪ Quantitative evaluation of chemicals discharged to collection system. ▪ Online monitoring that may indicate a chemical peak resulting from an illicit discharge. ▪ Coordination with the pretreatment program for notification of discharges above allowable limits. ▪ Monitoring of local surveillance programs to determine when community outbreaks of disease occur. ▪ Form a source control committee.

As a part of the wastewater collection system source control requirements, the reuse project sponsor must administer an industrial pretreatment and pollutant SCP that includes, at a minimum:

- An assessment of the fate of DDW-specified and RWQCB-specified chemicals and contaminants through the wastewater and recycled municipal wastewater treatment systems.
- Chemical and contaminant source investigation and monitoring that focuses on DDW-specified and RWQCB-specified chemicals and contaminants.
- An outreach program to industrial, commercial, and residential communities within the portions of the sewage collection agency's service area that flows into the WRP subsequently supplying the Groundwater Replenishment Reuse Project (GRRP), for the purpose of managing and minimizing the discharge of chemicals and contaminants at the source.
- A current inventory of chemicals and contaminants identified pursuant to this section, including new chemicals and contaminants resulting from new sources or changes to existing sources, that may be discharged into the wastewater system.
- Is compliant with the effluent limits established in the wastewater management agency's RWQCB permit.

An SCP must be implemented by the wastewater management agency to limit contaminants in wastewater used in IPR and DPR projects. The SCP has several required elements, including investigation and monitoring of SWRCB-specified chemicals and contaminants and an outreach program to industrial, commercial, and residential dischargers within the service area contributing to the IPR or DPR project. In addition, contaminant concentrations in the feedwater must be evaluated and compared against public health goals or results of the US Environmental Protection Agency (EPA) or analogous state agency conducted health risk assessments.

For DPR, an early warning program must also be implemented to alert for potential issues that could adversely impact the DPR treatment. It must include online monitoring that may indicate a chemical peak resulting from an illicit discharge, coordination with the pretreatment program for notification of discharges above allowable limits, and monitoring of local surveillance programs to determine when community outbreaks of disease occur.

3.4.3 Feedwater Quality Monitoring

There are no requirements for monitoring the feedwater for an IPR project, though monitoring is recommended to address any water quality challenges proactively.

For a DPR project, however, there are requirements for monitoring the feedwater. Prior to operation, the feedwater to a DPR project must be monitored monthly for a minimum of 24 months for regulated contaminants (i.e., those with a MCL, priority pollutants, NLS, a specific list of solvents, DBPs, and DBP precursors). Existing monitoring data meeting certain criteria may be substituted for 12 months of the required data. Appendix B lists the anticipated feedwater monitoring parameters.

3.4.4 Pathogen Control Requirements

Title 22 California Code of Regulations (CCR) requires that potable reuse projects for groundwater recharge provide a combined level of treatment resulting in 12-log virus, 10-log *Giardia*, and 10-log

Cryptosporidium reduction. No single process can receive more than 6-log reduction credit and at least three processes must provide at least 1-log reduction.

DPR projects must address the same three classes of pathogens as IPR, but with higher levels of pathogen reduction required. Treatment and monitoring systems must be designed and validated to attain 20, 14, and 15-log removal values (LRVs) for virus, *Giardia*, and *Cryptosporidium*, respectively. The treatment train must consist of at least four separate treatment processes for each pathogen type (a single process can receive credit for multiple pathogens), and each credited process must demonstrate at least 1-log reduction of the target pathogen.¹ In addition, the treatment train shall consist of at least one physical separation process, one chemical disinfection process, and one UV disinfection process.

For each treatment process that is proposed to receive pathogen reduction credit in an IPR and DPR project, a validation study must be conducted, and a report of the results must be submitted to the SWRCB.

3.4.5 Wastewater Treatment Requirements

The IPR regulations and current draft DPR regulations do not specify performance criteria for the WWTP. However, there are some discussions about a potential requirement that the WWTP provides nitrification for DPR projects. The level of nitrification, and the related public health and operational benefits of nitrification, are not defined at this time.

3.4.6 Treatment Train Requirements

GWR by means of injection must undergo full advanced treatment of RO and AOP. Because this project will consider using injection, the treatment train must include the RO and UV AOP. While membrane pretreatment ahead of RO is not required from a regulatory standpoint, it is a necessary process for protection of the RO membranes. These pretreatment membranes can be either UF or MBR. Note that UF provides for the reduction of protozoa (*Giardia* and *Cryptosporidium*) whereas MBR provides for virus reduction as well as reduction of the two listed protozoa.

The regulations contain an alternatives clause, which allows for the use of other treatment technologies if the project can demonstrate that the following Title 22 conditions can be met:

- Provides the same level of protection of public health.
- Requires an IAP to approve the project.
- Is approved by the DDW.
- The project sponsor must conduct a public hearing.

No alternatives are proposed pertaining to this project.

¹ Per the June 2022 DDW Response to Expert Panel Comments, clarification was added to note that the ozone and BAC processes must each separately provide 1-log reduction.

In terms of DPR regulations, additional prescriptions for required treatment have been included and are summarized below:

- In addition to RO and an AOP, as required for IPR, the treatment train for DPR must include ozone/BAC ahead of RO.² It must also subsequently include UV disinfection with a dose of at least 300 millijoules per centimeter squared (mJ/cm²).
- The system must be designed to meet specific response time requirements to ensure that diversion and/or shutoff can occur in the event of a failure to meet the pathogen and/or chemical control requirements. If a failure is identified, the system must divert or shut off before 10 percent of the off-spec water reaches the diversion or shutoff point.
- The ozone process must be designed to provide an ozone dose that results in a ratio of the applied ozone dose to the design feedwater TOC greater than 1.0 (after accounting for nitrite which exerts an ozone demand). Lower ozone to TOC ratios must be proven through pilot testing of performance.
- The BAC process must be designed with an empty bed contact time (EBCT) of at least 15 minutes. An EBCT less than 15 minutes can be proposed as an alternative with pilot/demo data.
- Ozone/BAC may not be required if potable reuse flow is less than 10 percent of drinking water in the distribution system.

3.4.7 Chemical Control Requirements

The PRW from the WWTPs in Solvang, Buellton, and SSD must be of high quality and meet all regulated parameters prior to injection. Consequently, monitoring is required throughout the treatment system. This monitoring includes online and grab sample monitoring for performance indicators, performance surrogates, and a broad range of chemical pollutants (MCLs, NLs, sMCLs, Contaminants of Emerging Concern [CECs], per- and poly-fluorinated substances [PFAS], nitrosamines, DBP, and Basin Plan Water Quality Objectives). The water quality limits for groundwater recharge with recycled water are defined in Appendix B.

DPR product water must meet all existing standards for drinking water, and there is also a stricter limit on RO permeate TOC. Requirements include:

- Monthly monitoring in the product water is required. Product water must meet all current drinking water standards, including MCLs, DBPs, and ALs, listed in Appendix B.
- The TOC shall not exceed 0.5 mg/L prior to distribution, for both IPR and DPR regulations. TOC shall be monitored continuously, at an anticipated frequency of 15 minutes.
- For the ozone process, at least one surrogate or operational parameter shall be monitored continuously to confirm a minimum of 1 log removal of carbamazepine and sulfamethoxazole are being met.

² The latest version of the draft regulations has included a provision that allows for a treatment train without ozone/BAC, provided that the purified water comprises 10 percent or less of total water supplied on a continuous basis. Partial ozone/BAC treatment is allowable if purified water will comprise up to 50 percent of the total water supplies. For example, if the purified water were going to make up 25 percent of the water supplied, then approximately 75 percent of the purified water would need to be treated through ozone/BAC.

- For the BAC process, at least one surrogate or operational parameter shall be monitored continuously to confirm a minimum of 1 log removal of formaldehyde and acetone are being met.
- Continuous monitoring of the ozone feedwater for nitrate is required.
- Nitrate and nitrite must be continuously monitored in the RO permeate. Continuous monitoring of lead and/or perchlorate may also be required if the required weekly grab samples indicate that it is justified. The control system must be designed to automatically divert purified water if there is an exceedance of the TOC limit, the nitrate MCL, and potential levels for perchlorate and lead.
- In order to address a potential chemical peak, the system must provide sufficient mixing at some point prior to distribution to attenuate a 1-hour elevated concentration of a contaminant by a factor of 10 (10:1 dilution). This dilution can occur at any point in the treatment and distribution process before the water is consumed. Examples include:
 - » *Peak attenuation within a WWTP, such as occurs with return activated sludge recycle streams.*
 - » *Peak attenuation in an EQ basin, such as primary EQ or tertiary effluent EQ.*
 - » *Peak attenuation within a distribution system, such as blending within a water storage reservoir before distribution to customers.*

3.4.8 Additional Monitoring Requirements

Inorganic chemicals (except nitrogen compounds), radionuclides, organic chemicals, DBPs, lead, and copper require quarterly monitoring while sMCLs require annual monitoring per CCR 60320.112 for IPR projects.

The additional monitoring requirements for IPR have been expanded for DPR to include additional locations and additional classes of chemicals. In addition, the frequency is increased to weekly or monthly for many chemicals. Extensive chemical monitoring is required on an ongoing basis in the feedwater to the DPR project, the effluent from the AOP, and the finished water prior to entering distribution.³ In each location, monthly sampling is required for all MCLs, sMCLs, NLs, priority toxic pollutants, alert levels, DBPs and DBP precursors, and specified solvents, as listed in Appendix B. Weekly sampling is required for nitrate, nitrite, perchlorate, and lead. In addition, quarterly sampling is required for business/household pharmaceuticals and personal care products and other chemicals as prescribed by the State Board.

The SWRCB last amended its Recycled Water Policy in 2018 with a revised list of CECs recommended for monitoring in potable water reuse projects.^{4,5} The amendment contains a revised list of CECs recommended for monitoring in potable water reuse projects. CECs with health-based significance are assigned health-based screening levels, or monitoring trigger levels, which are designated for different types of potable reuse. The required monitoring locations for CECs and surrogates are such that

³ DDW may allow for the finished water sampling location to be used to satisfy the requirement for the post-oxidation sampling point.

⁴ SWRCB (2018) Regulations Related to Recycled Water. Sacramento, CA.

https://www.waterboards.ca.gov/drinking_water/certlic/drinkingwater/documents/lawbook/rwregulations.pdf.

⁵ Updates were based on the 2018 reconvened science advisory panel published Monitoring Strategies for CECs in Recycled water, Recommendations of a Science Advisory Panel (Southern California Coastal Water Research Project, 2018).

health-based CEC monitoring follows treatment, prior to release to the pipeline, while performance-based CEC monitoring is typically at two locations: Prior to RO (or AOP if RO does not substantially remove a CEC and is allowed by the RWQCB) and following all treatment prior to release to the pipeline.

3.4.9 Groundwater Requirements

Groundwater IPR projects require a minimum retention time of 2 months that must be verified using a tracer study (either intrinsic or seeded).

Groundwater augmentation allows for storage of excess water underground, allows for increased groundwater pumping, and can push back seawater intrusion. The proposed groundwater augmentation for this project, via injection, requires construction of wells accompanied by the necessary monitoring wells per regulation. For this project, existing extraction wells would be used (no new extraction wells). Further details regarding monitoring wells and construction for the proposed use of PRW are discussed in Chapter 5.

3.4.10 Operational Requirements

Prior to operation, a project sponsor shall submit an Operation Optimization Plan (OOP) to the DDW and Central Coast RWQCB. The OOP describes the operations, maintenance, analytical methods, operating procedures, response and action plans, monitoring and reporting, staffing plan and chain of command under normal and extenuating operating conditions to ensure regulatory compliance. The OOP describes how treatment processes will be operated in a manner providing optimal reduction of all chemicals and contaminants including pathogens and regulated and unregulated constituents.

For IPR projects, DDW does not require 24 hour per day operation, noting that the operational plan for any AWPf requires review and approval by DDW and required hours per day on site may vary from one plant to another. For the IPR AWPf, DDW requires the CPO to be a minimum Grade 3 AWTO and progress to Grade 5 AWTO within two years after project start. DDW also requires the Lead Shift operator to be a minimum Grade 3 AWTO.

The draft DPR regulations contain more extensive requirements for operators and the required certifications. DPR projects are required to designate at least one chief operator with a T5 water treatment operator certification and one shift operator with a T3 certification to oversee the operations of the entire treatment train used to comply with the requirements (this may include a WWTP, AWPf, and drinking WTP). There are also requirements for each facility that provides pathogen and/or chemical control. At these facilities, there must be one chief operator that is AWTO Grade 5 certified and one shift operator that is AWTO Grade 3 certified.⁶ Either the chief or shift operator with AWTO certification must be present on site at all times, except as described below. All operators at the advanced treatment facility must be AWTO certified (can be at any grade). The latest version of the draft regulations does allow for some degree of remote operations after 12 months of operation. The chief or shift operator must still be able to monitor operations and exert physical control over the treatment facility within a maximum of one hour.

⁶ To obtain AWTO certification, a Grade 3 water or wastewater treatment operator certification is needed.

3.4.11 Plans and Reporting

3.4.11.1 Basin Plan Requirements

The Basin Plan requirements for groundwater subsurface injection of treated water are based on the Water Quality Control Plan for the Central Coastal Basin and dictate the quality of IPR water produced.⁷ Water quality requirements for injected IPR water are dependent on the underlying sub-basin. Requirements for these sub-basins correlating to the three IPR projects explored are summarized in Table 3.3.

Outlined in Table 3.3 the major parameter of concern is boron, as it is difficult to reduce concentrations of this constituent down to the objective levels outlined in the Basin Plan through typical treatment processes.

Table 3.3 Central Coast Basin Median Groundwater Objectives

Parameter	Solvang IPR Santa Ynez Sub-Basin Criteria ⁽¹⁾	Buellton IPR Santa Rita Sub-Basin Criteria ⁽¹⁾	Summerland IPR (via Carpinteria Planned Project) Carpinteria Sub-Basin Criteria ⁽¹⁾
Boron, mg/L	0.5	0.5	0.2
Chloride, mg/L	50	150	100
Sodium, mg/L	20	100	100
Sulfate, mg/L	10	700	150
TDS, mg/L	600	1,500	700
Total Nitrogen, mg/L	10	10	7

Notes:

(1) SWRCB 2019c. Objectives are median values.

3.4.11.2 Indirect Potable Reuse Reporting

No later than six months after the end of each calendar year, a project sponsor shall provide a report to the Department and Regional Board. Public water systems and drinking water well owners having downgradient sources potentially affected by the GRRP and within 10 years groundwater travel time from the GRRP shall be notified by direct mail and/or electronic mail of the availability of the report. The report shall be prepared by an engineer licensed in California and experienced in the fields of wastewater treatment and public water supply. The report shall include the following:

- A summary of the GRRP compliance status with the monitoring requirements and during the previous calendar year.
- For any violations during the previous calendar year, including the date, duration, and nature of the violation. A summary of any corrective actions and/or suspensions of subsurface application of recycled municipal wastewater resulting from a violation shall be included, and a schedule for and summary of all remedial actions shall be provided if uncorrected.

⁷ SWRCB (2019). Water Quality Control Plan for the Central Coast Basin, June 2019.

https://www.waterboards.ca.gov/centralcoast/publications_forms/publications/basin_plan/docs/2019_basin_plan_r3_complete_webaccess.pdf.

- Any detections of monitored chemicals or contaminants, and any observed trends in the monitoring wells and diluent water supplies.
- Information pertaining to the vertical and horizontal migration of the recharge water plume.
- A description of any changes in the operation of any unit processes or facilities.
- A description of any anticipated changes, along with an evaluation of the expected impact of the changes on subsequent unit processes.
- The estimated quantity and quality of the recycled municipal wastewater and diluent water to be applied for the next calendar year.
- A summary of the measures taken to comply with wastewater source control and the assurance that the project sponsor must use recycled municipal wastewater from compliant wastewater management agency for GWR in GRRP, and the effectiveness of the implementation of the measures.
- Increases in recycled municipal wastewater contribution (RWC) during the previous calendar year and RWC increases anticipated for the next calendar year. For an RO based injection project, the RWC is 100 percent from the start.

Every five years from the date of the initial approval of the engineering report required pursuant to engineering report, a project sponsor shall update the report to address any project changes and submit the report to the Department and RWQCB. The update shall include, but not be limited to:

- Anticipated RWC increases, a description of how the RWC requirements in RWC will be met, and the expected impact the increase will have on the GRRP's ability to meet the requirements.
- Evidence that the requirements associated with retention time in pathogenic microorganism control, if applicable, and response retention time have been met.
- A description of any inconsistencies between previous groundwater model predictions and the observed and/or measured values, as well as a description of how subsequent predictions will be accurately determined.

3.4.11.3 Direct Potable Reuse Plan Requirements and Reporting

DPR projects will be required to prepare several plans that are not required for IPR projects. These plans provide extensive documentation of the public health protection elements of the system, and how any issues or failures will be addressed and mitigated. Compliance reporting to the SWRCB will be required on a monthly basis.

There are several plans that must be prepared prior to the operation of a DPR project; these plans must also be updated and maintained over time, and some require periodic review by the IAP. These include:

- **Joint Plan:** Describes all agencies involved in the DPR project, their roles and responsibilities, and procedures to implement the requirements of the DPR regulations. The Joint Plan also describes procedures for corrective actions that may be taken in the event of a failure to meet the requirements, procedures for public notifications, and provisions for backup supply in the event that purified water is not available.
- **Water Safety Plan:** Requires project proponent to conduct a hazard analysis that considers all steps in the drinking water supply chain from wastewater source to consumer. The Water Safety Plan

documents the result and describes risk management controls necessary beyond those outlined in these regulations (e.g., critical limits, monitoring, and corrective actions).

- **Engineering Report:** Details the design criteria of the DPR project as well as facilities, staffing, and support services required to continuously produce safe drinking water. The report must also include a third-party review of the DPR project design. The report must be reviewed and approved by the SWRCB and updated every five years to account for any design changes.
- **Operations Plan:** Describes the operations, maintenance, and monitoring necessary for a DiPRRA to meet the regulatory requirements. The plan must also identify an ongoing training program covering several topics related to DPR operations. The plan must be reviewed and approved by the SWRCB.
- **Pathogen and Chemical Control Point Monitoring and Response:** Describes the monitoring and response for each treatment process used to comply with the LRV requirements. Describes online monitoring, control system, alarms and failure response actions, and other items. The plan must be reviewed and approved by the SWRCB.
- **Monitoring Plan:** Describes monitoring conducted for SCP, treatment process monitoring, chemical monitoring, and any other required monitoring. The Monitoring Plan also describes follow-up actions that will be taken in the event of an MCL or NL exceedance in the purified water. The plan includes schedules, laboratories used, analytical methods, quality assurance procedures, calibration and verification plans, and other items. Reporting of the results of monitoring would be performed monthly, including all online and grab sample results.
- **Corrosion Control and Stabilization Plan:** Describes how the DiPRRA and any other public water systems receiving finished water will address potential impacts resulting from the introduction of purified water into the distribution system.
- **Additional Reporting:** Requires an annual, publicly available report detailing the DPR project's response to climate change. The report includes identified climate change threats and steps taken relative to the DPR project to adapt to these threats as well as mitigate greenhouse gas contributions to the atmosphere.

The DiPRRA must submit monthly compliance reports to the SWRCB including a summary and results of the month's treatment plant compliance monitoring, including treatment performance records, summary of log reduction performance, any excursions outside approved operating limits, calibration records, equipment failures and corrective actions, analytical results of water quality monitoring, and other items.

3.5 Regulation Development and Summary

IPR regulations are completed and well understood and implemented.

The current DPR draft regulations contain extensive requirements for treatment, monitoring, source control, reporting, and more. The framework remains similar to what has been promulgated for IPR, but many of the requirements have been made more stringent, and new elements have been introduced. It is important to note that they are still in draft form, and the final version of the regulations may look different. With that in mind, the key elements of the draft regulations are defined below, with a comparison summary of IPR and draft DPR regulations in Table 3.4.

Table 3.4 Summary Comparison of Key Regulatory Requirements for IPR - GWR (Direct Injection) and DPR - TWA

Regulatory Requirement	IPR - GWR	DPR - TWA
Project Structure and Interagency Coordination	<ul style="list-style-type: none"> Main entity is project sponsor. 	<ul style="list-style-type: none"> DiPRRA is the public water agency responsible for project. Joint Plan required.
Source Control	<ul style="list-style-type: none"> Requires industrial pretreatment and pollutant SCP including: <ul style="list-style-type: none"> Assessment of the fate of site-specific chemicals through the wastewater and recycled water treatment systems. Monitoring and investigation of chemical sources. Outreach program to minimize discharge of chemicals into the feedwater. 	<ul style="list-style-type: none"> Requires SCP. All elements of source control as needed for IPR. Quantitative evaluation of chemicals discharged to collection system. Online monitoring that may indicate a chemical peak resulting from an illicit discharge. Coordination with the pretreatment program for notification of discharges above allowable limits. Monitoring of local surveillance programs to determine when community outbreaks of disease occur. Form a source control committee.
Feedwater Monitoring	None.	<ul style="list-style-type: none"> Prior to operation, 24 months of monthly feedwater monitoring for regulated contaminants (i.e., those with an MCL), priority pollutants, NLs, a specific list of solvents, DBPs, and DBP precursors.
Pathogen Control	<ul style="list-style-type: none"> 12-log enteric virus. 10-log <i>Giardia</i>. 10-log <i>Cryptosporidium</i>. 	<ul style="list-style-type: none"> 20-log enteric virus. 14-log <i>Giardia</i>. 15-log <i>Cryptosporidium</i>.
Treatment Train	<ul style="list-style-type: none"> RO + UV/AOP required. 	<ul style="list-style-type: none"> Ozone/BAC + RO + UV/AOP required in this order.
Chemical Control	<ul style="list-style-type: none"> Maximum recycled water TOC contribution of 0.5 mg/L. Must meet all current drinking water standards, including MCLs, DBPs, and ALs. Quarterly monitoring. 	<ul style="list-style-type: none"> Maximum effluent TOC contribution of 0.5 mg/L; additional more stringent TOC thresholds with response actions. Must meet all current drinking water standards, including MCLs, DBPs, and ALs. Monthly monitoring. Control of one-hour chemical spike. Continuous monitoring of nitrate and nitrite in RO permeate.
Additional Monitoring	<ul style="list-style-type: none"> Quarterly sampling in recycled water and downgradient groundwater wells for priority pollutants, unregulated chemicals, and NLs. 	<ul style="list-style-type: none"> Monitoring required in feedwater, directly after oxidation process, and finished water for: <ul style="list-style-type: none"> Monthly: All MCLs, sMCLs, NLs, priority toxic pollutants, ALs, DBPs and DBP precursors, and specified solvents. Quarterly: Chemicals known to cause cancer or reproductive issues for at least three years. Weekly monitoring of nitrate, nitrite, perchlorate, and lead in the finished water only.
Environmental Buffer	<ul style="list-style-type: none"> Minimum aquifer retention time of 2 months. 	<ul style="list-style-type: none"> No environmental buffer.

Regulatory Requirement	IPR - GWR	DPR - TWA
Response Time	<ul style="list-style-type: none"> ▪ Minimum aquifer response retention time of 2 months. 	<ul style="list-style-type: none"> ▪ The system must be designed to meet certain response time requirements to ensure that diversion and/or shutoff can occur in the event of a failure to meet the pathogen and/or chemical control requirements. ▪ If a failure is identified, the system must divert or shut off before 10 percent of the off-spec water reaches the diversion or shutoff point.
Operations	<ul style="list-style-type: none"> ▪ CPO must be a minimum of AWTO Grade 3 and progress to AWTO Grade 5 within two years after project start. ▪ Lead shift operator must be a minimum AWTO Grade 3. 	<ul style="list-style-type: none"> ▪ Chief operator with T5 and shift operator with T3 certifications required to oversee entire DPR treatment train (may include WWTP, AWPf, and WTP). ▪ AWTO Grade 5 required on site at all times, with some exceptions for remote operations allowed. ▪ All facility operators must be AWTO certified.
Plans	<ul style="list-style-type: none"> ▪ Engineering Report. ▪ Operations Optimization Plan. 	<ul style="list-style-type: none"> ▪ Joint Plan. ▪ Water Safety Plan. ▪ Engineering Report. ▪ Operations Plan. ▪ Pathogen and Chemical Control Point Monitoring and Response. ▪ Monitoring Plan. ▪ Corrosion Control and Stabilization Plan. ▪ Additional Reporting (climate change).
Reporting	<ul style="list-style-type: none"> ▪ Annual compliance reporting. 	<ul style="list-style-type: none"> ▪ Monthly compliance reporting.

CHAPTER 4 TREATMENT SUMMARY

4.1 Introduction

This chapter considers available wastewater effluent data to develop an overview of the anticipated processes and sizing of treatment trains for implementing either indirect or direct potable reuse (IPR or DPR) for the Buellton and Solvang projects.

4.2 Proposed Advanced Water Purification Facility Information

City of Buellton and City of Solvang were selected for the development of AWPf based on careful considerations such as the availability of effluent, the demand for water supply, and the expressed interest of local utilities. Both IPR and DPR AWPf were proposed for Buellton and Solvang, respectively. Furthermore, a combined facility was also proposed for IPR and DPR utilizing the wastewater effluent from both Buellton and Solvang. These advanced water treatment (AWT) trains are summarized in Figure 4.1 and Figure 4.2. Additional information about each train is provided in the sections below. The summary of advanced treatment alternatives in Buellton and Solvang is presented in Table 4.1.

Table 4.1 Summary of Alternative Reuse Treatment Trains in Buellton and Solvang

City	Wastewater Treatment	Reuse Type	Advanced Treatment	Secondary Effluent Flow (mgd)	Finished Water Flow ⁽²⁾ (mgd)
Buellton ⁽¹⁾	Conventional Activated Sludge	Indirect Potable	UF - RO - UV/AOP	0.43	0.33 ⁽¹⁾
		Direct Potable	Ozone/BAC - UF - RO - UV/AOP	0.43	0.31 ⁽¹⁾
Solvang	Conventional Activated Sludge	Indirect Potable	UF - RO - UV/AOP	1.0 ⁽³⁾	0.76
		Direct Potable	Ozone/BAC - UF - RO - UV/AOP	1.0 ⁽³⁾	0.71
Buellton + Solvang ⁽¹⁾	Conventional Activated Sludge	Indirect Potable	UF - RO - UV/AOP	1.02	0.78
		Direct Potable	Ozone/BAC - UF - RO - UV/AOP	1.02	0.73

Notes:

- (1) The City of Buellton has noted that there is interest in utilizing a portion of their wastewater effluent at nearby construction sites for uses such as dust control, grading, and compaction. Water for use at construction sites does not need to be treated to the same quality standards as evaluated in this chapter. Should the City of Buellton pursue a potable reuse project further, a more comprehensive evaluation of construction water demand should be performed and treatment needs should be adjusted accordingly.
- (2) Backwash flows from one or more processes can be returned to the head of the respective WWTPs or can be discharged as an effluent. Future more detailed flow analysis can evaluate the cost and benefit of maximizing water recovery from backwash water.
- (3) The Solvang AWPf is sized for 1.0 mgd of equalized flow to capture PWWFs during storm events. Typical secondary effluent flow is closer to the ADWF of 0.59 mgd. Anticipated finished water flow at the ADWF is 0.46 mgd for IPR and 0.43 mgd for DPR. As noted previously, depending on results of ongoing discussions with the RWQCB, if treatment of all flow is not required the AWPf may be designed for the lower ADWF flow.

4.3 Proposed Process Trains

The IPR treatment train process flow diagrams are shown on Figure 4.1 and the DPR treatment process flow diagrams are shown on Figure 4.2.

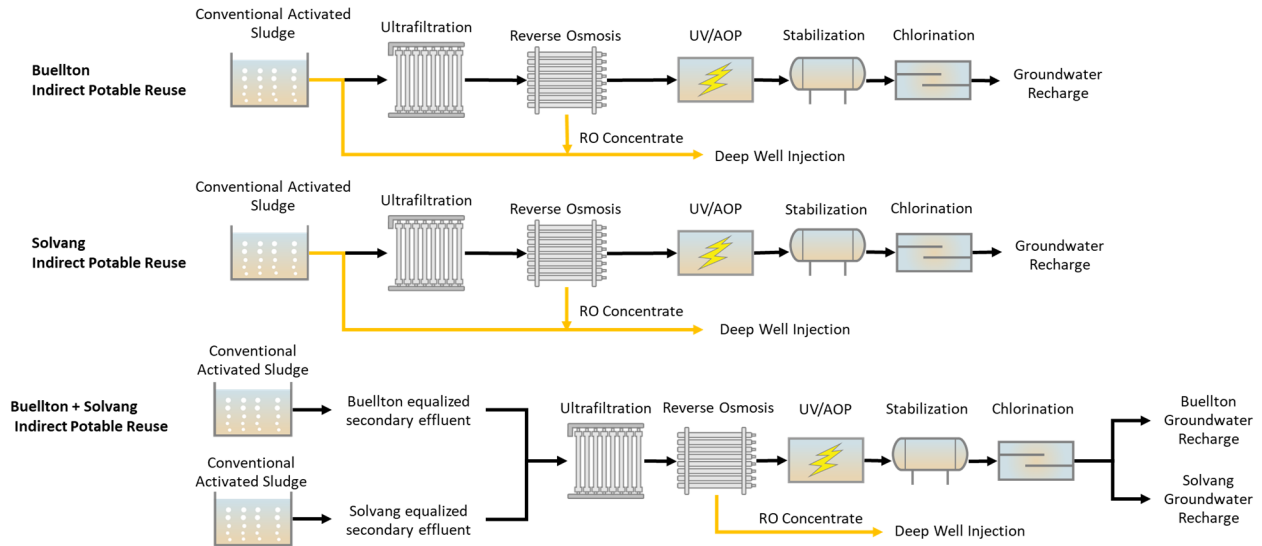

Figure 4.1 IPR Treatment Trains

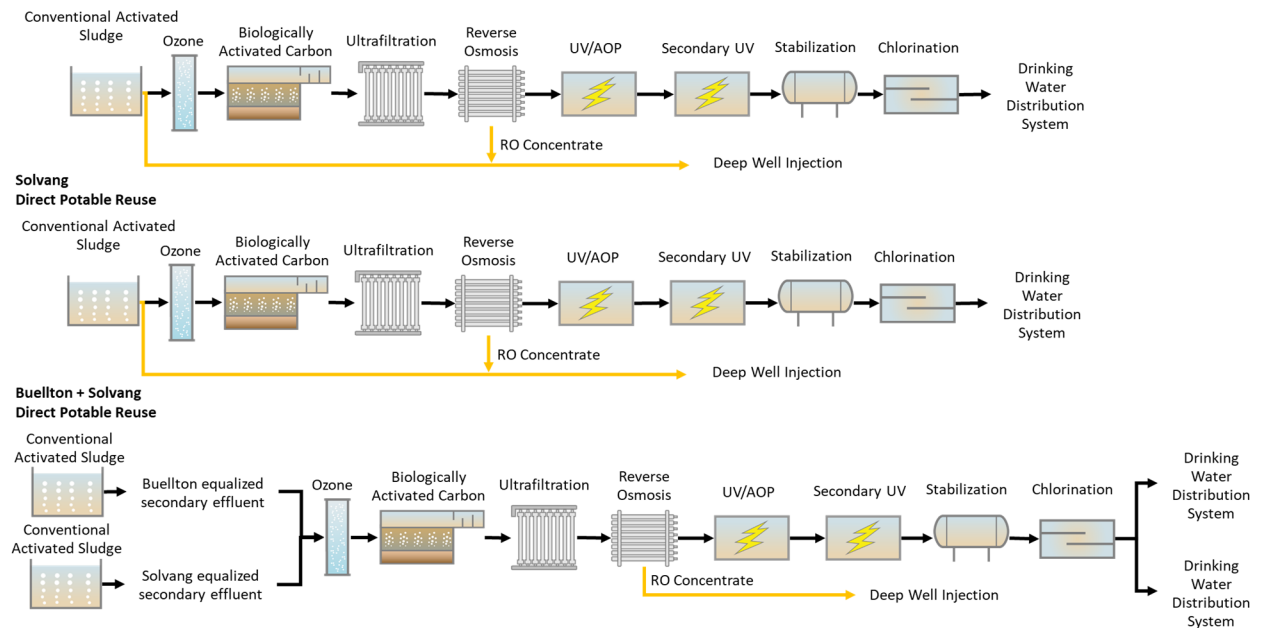

Figure 4.2 DPR Treatment Trains

4.4 Advanced Water Purification Facility Design Criteria

For this project, the criteria for IPR and DPR applies and will be met with a combination of advanced treatment processes listed in Table 4.2. These unit processes achieve the requirements for IPR and DPR as described in Table 4.3.

Table 4.2 Treatment Processes for IPR and DPR and Their Role in Meeting the Regulatory Requirements

Process	Role in Treatment Train	IPR	DPR
Ozone	Provides additional pathogen reduction needed for DPR		✓
BAC	Provides additional reduction of organics needed for DPR		✓
UF	Provides pretreatment for RO; also provides pathogen removal for protozoa	✓	✓
RO	Provides removal of pathogens and chemicals	✓	✓
UV/AOP	Provides removal of pathogens and chemicals	✓	✓
Chlorination	Provides additional disinfection of pathogens	✓	✓
Stabilization (calcite contactors)	Provides remineralization of water post-RO to protect distribution system pipes	✓	✓
Blending	Provides additional reduction of pathogen and chemical concentrations required for DPR		✓

Table 4.3 Treatment Process Descriptions and Requirements

Process	Description
Ozone	<ul style="list-style-type: none"> ▪ Provides pathogen disinfection. ▪ Facilitates biological treatment by breaking down organic carbon for removal by the downstream biological filters. ▪ Reduces concentrations of some chemicals and metals, such as iron and manganese, through chemical oxidation, thereby: <ul style="list-style-type: none"> » Decreasing toxicity of product water and potentially RO feed and brine concentration. » Providing effective pretreatment of water upstream of membranes thereby reducing fouling potential and required level of chloramines.
BAC Filtration	<ul style="list-style-type: none"> ▪ Biological filtration process. ▪ Removes organic carbon, made more bioavailable by the upstream ozone process. ▪ Decreases level of some chemicals, including NDMA. ▪ Reduces turbidity. ▪ Can provide some nitrification.
UF	<ul style="list-style-type: none"> ▪ Reduces turbidity in filtrate to meet the following: <ul style="list-style-type: none"> » No more than 0.15 for two consecutive 15-minute data points. ▪ Removes pathogens via size exclusion through membranes. ▪ Provides necessary pretreatment upstream of RO and UV/AOP similar to all existing California potable reuse plants.
RO	<ul style="list-style-type: none"> ▪ Reduces TOC to meet regulatory limit of 0.25 mg/L for the first 20 weeks of operation (IPR). ▪ Reduces TOC to meet regulatory limit of 0.15 mg/L for 120 hours and 0.1 mg/L for at least 24 hours. ▪ Reduces TDS. ▪ Decreases level of all chemicals with high molecular weights, and uncharged chemicals with low molecular weights. ▪ Removes pathogens via size exclusion. ▪ Effectively removes many CECs, including PFAS.

Process	Description
UV/AOP	<ul style="list-style-type: none"> Combination disinfection and chemical oxidation process. Provides pathogen disinfection. Achieves oxidation requirement by providing no less than 0.5-log (69 percent) reduction of 1,4-dioxane. Providing this level of reduction also ensures that other unregulated chemicals are also reduced through this process. Provides final chemical abatement, including for 1,4-dioxane and NDMA.
Chlorination	<ul style="list-style-type: none"> Provides pathogen disinfection.
Stabilization (calcite contactors)	<ul style="list-style-type: none"> Provides corrosion control. Required for water treated by RO.
Secondary UV Disinfection	<ul style="list-style-type: none"> Disinfection process. Provides final pathogen disinfection to meet full draft DPR pathogen removal requirements.
Blending	<ul style="list-style-type: none"> Meets draft DPR blending requirement to reduce a one-hour chemical spike by a factor of 10. Provides response time if a monitoring alarm were to signal an issue in the upstream treatment.

The pathogen log removals for each process are summarized and compared to the total required log removals in Table 4.4 for IPR and Table 4.5 for DPR.

Table 4.4 Pathogen LRVs per Process for the IPR Treatment Trains

Process	Pathogen Log Removals by Pathogen Category		
	Virus	<i>Giardia</i>	<i>Cryptosporidium</i>
WWTP ⁽¹⁾	0+	0+	0+
UF ⁽²⁾	0	4	4
RO ⁽³⁾	1.5	1.5	1.5
UV/AOP	6	6	6
Chlorination	0–5 ⁽⁴⁾	0	0
Stabilization	0	0	0
Groundwater Basin	2–6 ⁽⁴⁾	0	0
Total	>12	11.5	11.5
Required	12	10	10

Notes:

- (1) Pathogen removal through the WWTP would need to be evaluated and confirmed through a 3- to 12-month study including evaluation of a broad range of pathogens and surrogates.
- (2) UF systems can remove virus (1.5 to 4+ LRV) but currently are not credited due to the lack of a reliable surrogate to be used daily to verify performance (e.g., pressure decay tests [PDTs] are used daily to verify protozoa removal).
- (3) Can receive up to 1 log credit during permitting for EC as a monitoring surrogate; 1.5 log credit for TOC, and 2 log for strontium. An additional half log can typically be gained once the facility is operational.
- (4) 1-log virus credit is granted for each month spent in the ground; the final virus credit received from time in the groundwater basin would be determined based on the anticipated retention in the ground prior to hitting a drinking water well. Free chlorine credit can be adjusted based on the needs to meet overall LRV requirements. Higher groundwater travel time will require less chlorine consumption.

Table 4.5 Pathogen LRVs per Process for DPR Treatment Trains

Process	Pathogen Log Removals by Pathogen Category		
	Virus	Giardia	Cryptosporidium
WWTP ⁽¹⁾	0+	0+	0+
Ozone/BAC ⁽²⁾	6	6	1
UF ⁽³⁾	0	4	4
RO ⁽⁴⁾	2	2	2
UV/AOP	6	6	6
Secondary UV Disinfection	4	4	4
Stabilization	0	0	0
Chlorination ⁽⁵⁾	Up to 5 ⁽⁶⁾	0	0
Total	23	22	17
Required	20	14	15

Notes:

- (1) Pathogen removal through the WWTP would need to be evaluated and confirmed through a 3- to 12-month study including evaluation of a broad range of pathogens and surrogates.
- (2) Based on US EPA protocols with a contact time (CT) of 6 milligram-minutes per liter (mg-min/L), providing a residual of more than 1 mg/L as ozone, the project will result in the credits assigned to Pure Water San Diego, shown here. Ozone decay test in the source water should be conducted to verify design and dosage parameters.
- (3) UF systems can remove virus (2 to 4+ LRV) but currently are not credited due to the lack of a reliable surrogate to be used daily to verify performance (e.g., PDTs are used daily to verify protozoa removal).
- (4) Can receive up to 1 log credit during permitting for EC as a monitoring surrogate; 1.5 log credit for TOC, and 2 for strontium. An additional half log can typically be gained once the facility is operational. 2 log credit would be defined by pilot work ahead of any DPR project through monitoring across RO.
- (5) Chlorination credits based upon the Australian WaterVal analysis, which has been approved by the State of California for up to 5 log reduction of virus.
- (6) Final free chlorine credits would be determined based on the need to meet LRV target after other unit process credits are confirmed.

The treatment trains for IPR and DPR were developed to meet the regulations described in Chapter 3. Table 4.6 and Table 4.7 summarize IPR and DPR design capacities for each treatment process, respectively. The processes are sized to provide the design final product flow, given the recoveries of upstream and downstream processes. Upstream processes must be sized at higher instantaneous flow rates to provide sufficient process effluent for backwashes and other losses. Water used for backwashes would be sent back to the headworks at the WWTPs. The backwash water is not anticipated to impact the performance of the WWTPs, though further analysis is recommended to confirm this. Water lost to ROC would be discharged through deep well injection (see Chapter 6 for additional discussion). Detailed treatment process design criteria for each of the alternatives can be found in Appendix C.

The sections that follow provide more information on each of the AWPf treatment processes.

Table 4.6 Summary of IPR Capacity Criteria for Each Alternative

Process and Criteria	Unit	Buellton	Solvang	Buellton + Solvang
UF				
Average Feed Flow	mgd	0.43	1.00	1.02
Net Filtrate Permeate	mgd	0.41	0.95	0.97
Recovery	percent	95	95	95
RO				
Average Feed Flow	mgd	0.41	0.95	0.97
Net Filtrate Permeate	mgd	0.33	0.76	0.78
Recovery	percent	80	80	80
UV/AOP				
Rated Feedwater (Effluent)	mgd	0.33	0.76	0.78
Dose	mJ/cm ²	1,000	1,000	1,000
Calcite Contactor				
Feedwater	mgd	0.33	0.76	0.78
Chlorination				
Feedwater	mgd	0.33	0.76	0.78
Concentration Time CT ⁽¹⁾	mg-min/L	9	9	9

Notes:

(1) 9 mg-min/L achieves 2 log virus reduction at pH ≤8.5 at 15 degrees Celsius based upon the Australian WaterVal analysis. Chlorine residual is anticipated at 3 mg/L.

Table 4.7 Summary of DPR Capacity Criteria for Each Alternative

Process and Criteria	Unit	Buellton	Solvang	Buellton + Solvang
Ozone + BAC				
Feed Flow	mgd	0.43	1.00	1.02
Rated Effluent	mgd	0.40	0.92	0.94
Recovery	percent	92	92	92
UF				
Average Feed Flow ⁽¹⁾	mgd	0.40	0.92	0.94
Net Filtrate Permeate	mgd	0.38	0.89	0.91
Recovery	percent	97	97	97
RO				
Average Feed Flow	mgd	0.38	0.89	0.91
Net Filtrate Permeate	mgd	0.31	0.71	0.73
Recovery	percent	80	80	80
UV/AOP				
Rated Feedwater (Effluent)	mgd	0.31	0.71	0.73
Dose	mJ/cm ²	1,000	1,000	1,000
Calcite Contactor				
Feedwater	mgd	0.31	0.71	0.73

Process and Criteria	Unit	Buellton	Solvang	Buellton + Solvang
Chlorination				
Feedwater	mgd	0.31	0.71	0.73
Concentration Time CT ⁽¹⁾	mg-min/L	9	9	9
UV (Disinfection)				
Feedwater	mgd	0.31	0.71	0.73
Dose	mJ/cm ²	186	186	186

Notes:

(1) 9 mg/L-min achieves 2 log virus reduction at pH ≤8.5 at 15 degrees Celsius based upon the Australian WaterVal analysis. Chlorine residual is anticipated at 3 mg/L.

4.4.1 Ozone and Biologically Enhanced Activated Carbon

Ozone is a chemical disinfection process that provides reduction for virus, *Cryptosporidium*, and *Giardia*. Ozonation also breaks down organic molecules to increase their bioavailability, thereby allowing improved chemical removal via biological degradation through BAC filtration. The BAC process can remove organic matter, including trace constituents and their ozonation byproducts, via the microbial communities that develop on the surface of the media. Ozone/BAC reduces TOC, NDMA, and trace organics. Ozone/BAC is required to be designed for DPR only. The use of ozone/BAC results in improvements to downstream UF performance, as the BAC filtrate is more biostable and causes less fouling on downstream membranes.

4.4.1.1 Ozone Process

The ozone process involves several components: Ozone gas generation, ozone injection into an ozone contactor, and destruction of off-gassed ozone.

To achieve LRVs of 6, 6, and 1 for virus, *Giardia*, and *Cryptosporidium*, respectively, the concentration times CT method is required. At a temperature of above 15 degrees Celsius (a conservative assumption based on the effluent data provided from 2018 through 2022), a concentration times CT of 6.43 mg-min/L is required for 1 LRV of *Cryptosporidium*. At that concentration times CT, virus and *Giardia* LRVs exceed 6, which is the maximum log removal that can be assigned to any one process. Both temperature sampling as well as ozone jar testing must be used to confirm the dose-response curve for ozone. Jar testing can also help determine the ozone transfer efficiency and number of ozone injection points required. Ozone design criteria are summarized in Appendix C.

4.4.1.2 Biologically Enhanced Activated Carbon Process

The BAC process can be in the form of a gravity or pressurized filter. For this analysis, pressurized filters were assumed for space efficiency, to manage nitrogen spikes and retain nitrification and to make better use of biologically active carbon filter feedwater pumping energy; however, the type of filter should be refined during design.

As the filtration run time increases over a period of days, solids and biomass build up on the filter media until a backwash is needed. The backwash process includes draining the filter, agitating the media with air scour, backwashing the media with a fluidized wash, and then refilling the filter and returning it to service. The entire backwash process typically lasts from 30 to 60 minutes.

A key design criterion for BAC is the EBCT, or the amount of time that the water resides with the filter media. Higher EBCT results in better biological degradation and TOC removal but increases capital and operational costs. The optimal EBCT should be selected through piloting; however, EBCTs of between 10 and 30 minutes are typical for wastewater effluents. The filtration systems for the DPR alternatives are sized to maintain an EBCT of at least 15 minutes at the design flow rates with one filter in backwash.

The BAC filter media typically used is granular activated carbon (GAC), selected to maximize surface area for biological growth and performance. Initially, the GAC will also provide additional treatment of chemicals by adsorbing chemical constituents; however, over time, as the adsorption sites are used up, the dominant chemical removal mechanism will become biological. BAC design criteria are summarized in Appendix C.

4.4.2 Ultrafiltration

The UF system is a low-pressure membrane filtration system that removes pathogens and removes particulate matter from secondary effluent (IPR) or BAC filtrate (DPR) in order to enhance downstream RO membrane performance.

The UF feed tank will store and equalize either secondary effluent (IPR) or BAC filtrate (DPR) and will also provide storage for BAC backwash water (DPR). UF feed pumps will pressurize flow from the UF feed tank through the UF system. Chloramine is added ahead of the UF system to minimize biofouling of the membranes. The UF modules and rack sizing was provided based on a design flux of 30 gallons per square foot per day (gfd) for IPR scenario. A design flux of 70 gfd for the UF modules and rack sizing was provided for the DPR scenario, resulting in cost savings (capital and operations). The achievable flux rate should be confirmed through pilot testing.

The UF filtrate/RO feed tank must provide both sufficient backwash volume for the UF system and feed flow for the RO. The UF clean-in-place (CIP) and neutralization tanks are designed to allow adequate water for conducting CIP maintenance on membranes followed by neutralization of cleaned membranes before being put back into use. Design criteria for the UF system are summarized in Appendix C.

4.4.3 Reverse Osmosis

RO is a well-established process used to remove contaminants that remain after the low-pressure membrane system. The RO process uses semi-permeable membranes and a driving force of hydraulic pressure to remove dissolved contaminants, making it a physical separation process that can reject constituents as small as 0.0001 micrometer. RO can remove dissolved salts, TDS, hardness, dissolved organic carbon, synthetic organic chemicals, and DBP precursors.

The basic unit of an RO system is the spiral-wound RO element, which consists of several layers of RO membranes wound around a central permeate collection tube and enclosed in a cylindrical housing. The membranes separate the feed flow into treated water (permeate) and a waste stream (concentrate). As feedwater flows along the length of the element, permeate passes through the membrane leaving behind most dissolved constituents, resulting in a progressively decreasing flow (concentrate) to carry the same mass of dissolved constituents. The ratio of the permeate production to the feed flow is known as the RO system recovery.

The permeate is composed of low salinity, high quality water. Some salts, neutrally charged chemicals, and gasses will pass through the RO membrane into the permeate. The concentrate stream contains the

remaining constituents that were trapped on the feed side. Since the ions being removed are further concentrated as the water passes through the system, there is potential for scaling and foulants to form on the membrane surface that can decrease the efficiency of the system. Scaling is prevented by the addition of sulfuric acid and chemical scale inhibitor (antiscalant) upstream of the RO process, which keep scale forming compounds in solution.

RO trains are typically designed in stages, the number of which depends on the water supply and the design recovery. In a typical advanced wastewater treatment RO system operating at 75 to 85 percent recovery, a two-stage system with multiple RO elements per pressure vessel is typical. In a two-stage system, the concentrate from the pressure vessels in the first stage is combined and fed to a smaller number of pressure vessels in a second stage. This approach increases the RO system's recovery.

The RO transfer pump located in the RO feed tank supplies UF filtrate to the RO feed pump, which provides the pressure needed for the RO train, UV reactor, and chlorine contactor. Solids, such as fine sands or organic debris, will result in RO membrane fouling and may cause mechanical damage to the RO membrane elements. Although the UF system will provide exceptionally high-quality water that is free of suspended solids, cartridge filters are still required to protect against membrane damage from suspended material that may be introduced into the RO feed tank, leftover construction debris, or other unexpected solids. Cartridge filters are provided as the final barrier to protect the valuable RO membrane elements against fouling or damage from these particulates. RO design criteria are provided in Appendix C.

4.4.4 Ultraviolet Disinfection/Advanced Oxidation

The UV disinfection system with an AOP component (typically referred to as UV/AOP) uses UV light coupled with an oxidant—in this case sodium hypochlorite—to break down organics via oxidative reactions and photolysis, and to disinfect pathogens. The UV light alone provides pathogen disinfection and photolysis reactions. Photolysis can lower concentrations of certain chemicals, such as NDMA. The AOP is required to lower concentrations of other chemicals, such as 1,4-dioxane, which serves as an indicator of AOP performance.

The AOP is achieved by introducing an oxidant into the system with UV light, which reacts with the oxidant to produce hydroxyl radicals. Hydroxyl radicals react rapidly with organics and lower the concentrations of a broad range of organic compounds. Appendix C summarizes UV/AOP system design criteria.

4.4.5 Ultraviolet Disinfection

A second UV system is necessary to meet virus log removal requirements for DPR. This system, which is disinfection only, also provides additional protozoa removal. UV disinfection design criteria are provided in Appendix C.

4.4.6 Stabilization

Water that has undergone RO treatment is exceedingly low in salts and minerals, with a low pH. Without the addition of minerals back into the water, RO permeate water can be aggressive and corrosive and should not be sent directly into a distribution system. The stabilization can be configured to match

existing water supply alkalinity and can be refined during the design phase of this project. Three options commonly considered for stabilization are as follows:

- **Option 1:** Calcite Contactor + Sodium Hydroxide + Carbon Dioxide (if necessary).
- **Option 2:** Hydrated Lime + Carbon Dioxide Dosing.
- **Option 3:** Calcium Chloride + Sodium Hydroxide + Carbon Dioxide.

For the purposes of this study, Option 1 (calcite contactors) were selected as they are an established technology used for conditioning RO permeate. The RO permeate is fed to the calcite contactor. If necessary, carbon dioxide is added to increase dissolved carbon dioxide. Projections during design suggested this would not be necessary. The flow can then be split (to allow fine tuning of stabilized water quality) and an appropriate portion diverted through a contactor dissolving/absorbing calcium carbonate as it passes through the bed of calcite. The flow is then recommended to provide additional stability to the finished water, where sodium hydroxide (i.e., sodium hydroxide or caustic soda) is necessary to increase the alkalinity of the RO permeate to provide buffer capacity and pH stability.

Option 2 adds lime slurry and carbon dioxide to the RO permeate. The addition of lime raises the pH, adds alkalinity, meeting calcium carbonate saturation objectives. Carbon dioxide addition then lowers the pH level back down to a target range to minimize scaling of the injection well screens. One concern with implementing Option 2 is that lime can increase the turbidity of the water, which could hinder public perception of the water. Lime addition can also be challenging to operate.

Option 3 adds calcium chloride, sodium hydroxide, and carbon dioxide to the RO permeate to stabilize the finished water. The addition of calcium chloride and sodium hydroxide adds calcium, alkalinity, and TDS to achieve the finished water corrosion objectives. Carbon dioxide lowers the pH level to remain in a reasonable range.

The preferred stabilization method should be refined during detailed design. The cost differences for the three stabilization methods were not evaluated for this project. Work on prior, similar potable reuse projects suggest that generally Option 1 is found to be more operable and economically feasible at low flows (1 to 5 mgd) but may become more expensive at higher flow (above 10 mgd) when compared to alternative stabilization approaches. Stabilization criteria for selected Option 1 are provided in Appendix C.

4.4.7 Chlorine Disinfection

A chlorine contact tank provides additional disinfection before the purified water is distributed to the water distribution systems in Buellton and Solvang, respectively. Free chlorination credits are based on the 2017 Australian WaterVal Validation Protocol. As indicated in the design criteria denoted in Appendix C, the tank will be designed to target a CT (i.e., concentration times contact time) of 9 mg/min-L with a 3-minute CT and a baffle factor of 0.1 (appropriate assumption for an unbaffled tank).

This tank can also provide storage time that can contribute to the overall response time of the system that is needed to address off-spec water. As discussed in the draft DPR regulations (detailed in Chapter 3) the AWPf must be designed to ensure that, in the event of system failure, diversion or system shutoff can occur before more than 10 percent of the off-spec water reaches the diversion or shutoff point. The 30-minute response retention time provided by the chlorine contact tank will allow operations staff

30 minutes for online monitoring systems to cycle several times to confirm performance and divert flow if needed.

For virus removal, this project assumes two LRV from free chlorination to meet the 20 LRV total requirement. However, virus removal is likely occurring through other processes that currently do not have established crediting frameworks. Other processes likely achieving virus removal include the WWTP (which includes filtration), UF (which could achieve 3- to 4-log credit if online virus monitoring is established), and RO (which could achieve 2.5- or even 3-log credit using a more advanced monitoring system). Thus, our expectation is that the free chlorine credits will be supplemental by the time a project such as this is permitted. Effluent water will target a 3 mg/L free chlorine residual, per assumption. The target residual may change based upon pilot testing, future analysis, and input from Buellton and Solvang based on their respective residual targets.

Design criteria for the purified water tank are provided in Appendix C.

4.4.8 Blending

As part of the proposed DPR regulations, a 10:1 dilution of a one-hour chemical spike is required. This peak attenuation can occur at any point in the treatment and distribution process before the water is consumed. Thus, blending within the sewer collection system, the WWTP, a separate EQ basin, or within the distribution system could be considered. For this analysis, blending in the sewer collection system and/or the WWTP was not considered. Instead, new blending tanks at the AWPf are needed for Buellton and Solvang to achieve sufficient storage capacity for the required 10:1 dilution. It will be further discussed in Chapter 5.

4.4.9 Chemicals

Chemicals are used throughout the treatment train as described in the previous subsections. A chemical feed station will store the required chemicals and serve as a chemical refill station for chemical deliveries. Storage requirements for each chemical should be determined during design. Appendix C summarizes the chemicals required and the purpose for each chemical.

4.5 Advanced Water Purification Facility Layouts

Sufficient space was available at the Buellton site, covering 2.5 acres, and at the Solvang site, covering 3.5 acres, to accommodate all the necessary components within a single-story building. Each process is situated adjacent to a central underground channel for waste EQ and if necessary, diversion of off-spec flow from each process. The available spaces for Buellton and Solvang are shown in Figure 4.3 and Figure 4.4. Layouts were developed for the Buellton and Solvang AWPf alternatives for IPR and DPR scenarios as shown in Figure 4.5 through Figure 4.10 for zoom-out plant view and Figure 4.11 through Figure 4.16 for zoom-in plant view with processes labeled. The layouts include plant feed pump stations, all treatment processes, ancillary equipment such as chemical storage, and the on-site blending tank for DPR scenario.

Some of the assumptions/decisions that went into these particular layouts are as follows:

- The plant feed pump station provides the feed pressure required to move water through ozone and BAC and into the UF feed tank.

- The UF feed tank and RO feed tanks are constructed at grade. An air gap is required after BAC, after UF, after RO, and after UV treatment.
- The chemical equipment was located close to the point of use to minimize the length of chemical line to avoid possible plugging issues.
- All chemical tanks, with the exception of antiscalant, are located outside under canopies. This can be further appropriately evaluated during design. Sodium hypochlorite should be ordered to remain on site for no longer than 2 to 3 weeks to avoid DBP generation due to decay.
- Most of the chemicals are required with low volume and will be only stored in totes without building tanks, except sodium hydroxide and sodium hypochlorite that will be used at larger volumes and would be more efficiently stored in fixed tanks and delivered by tanker load.
- All tanks are located above grade except for the waste EQ tank, which collects the waste flows from each system before pumping them out at a constant rate to the sewer or head of the WWTP. The EQ tank in Solvang will be below grade.
- A new, dedicated space for the AWPf's control room is provided. There is sufficient space in this room for a small wet lab installation or storage. It is possible that these spaces can be combined elsewhere with existing control rooms, labs, and staff areas during detailed design.

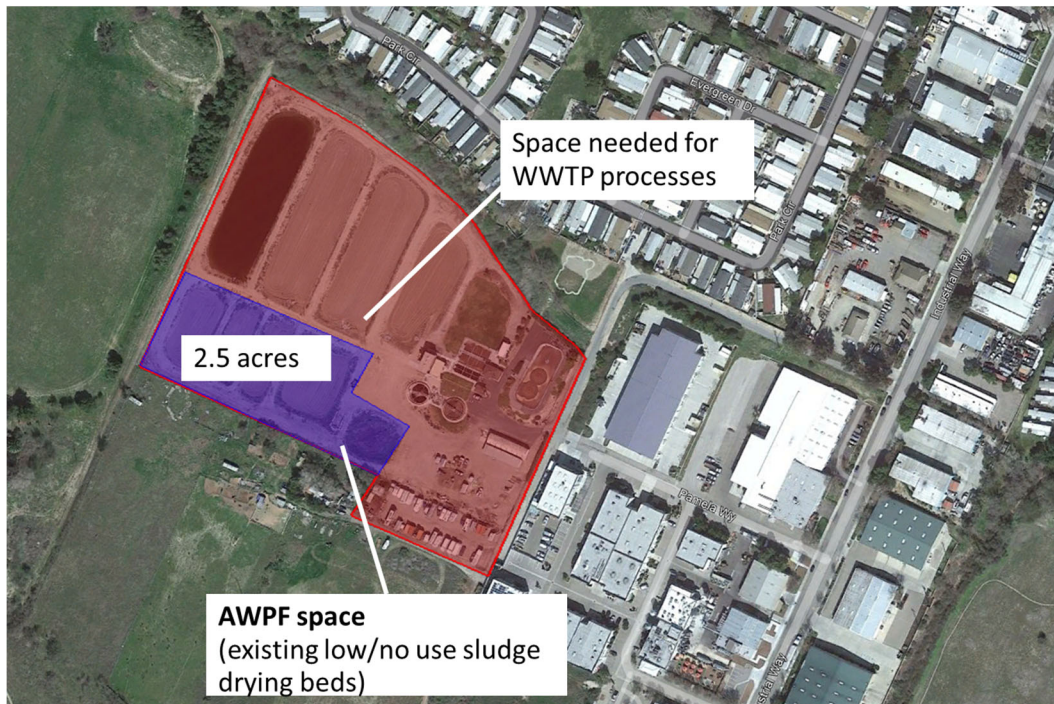

Figure 4.3 Available Space for AWPf in Buellton

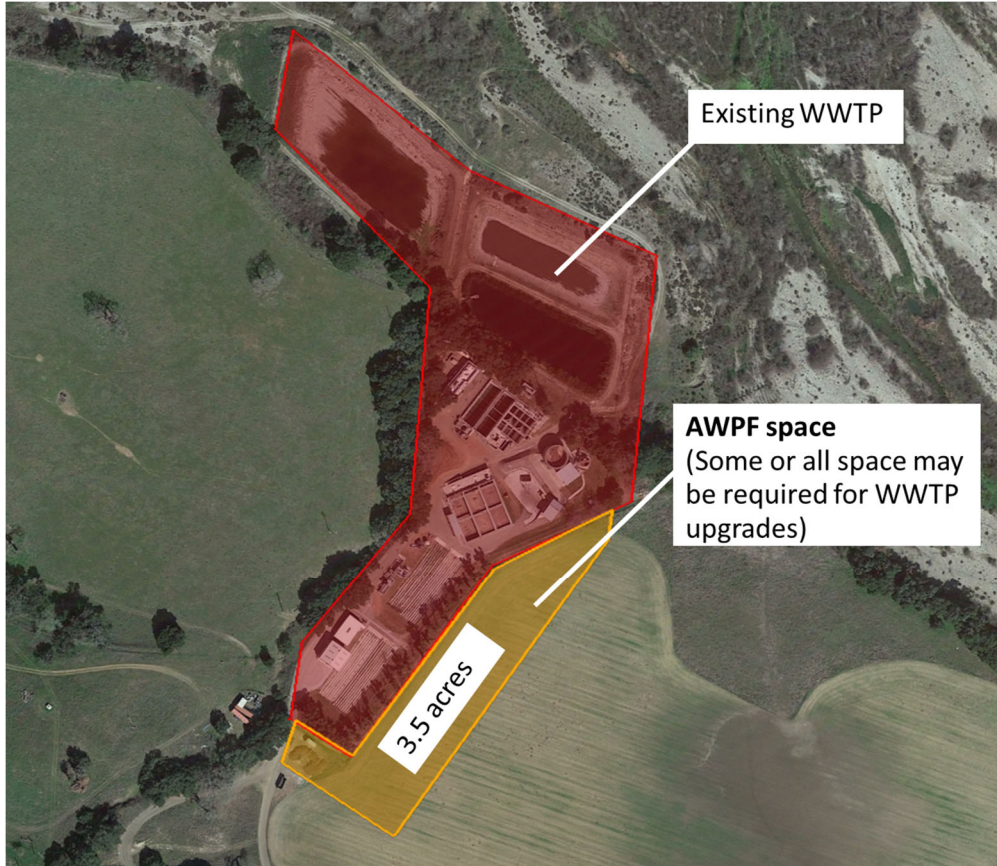

Figure 4.4 Available Space for AWPF in Solvang



Figure 4.5 Buellton IPR AWPF Zoom-Out Site Plan for 0.33-mgd Production



Figure 4.6 Solvang IPR AWPf Zoom-Out Site Plan for 0.76-mgd Production



Figure 4.7 IPR AWPf Zoom-Out Site Plan of Buellton and Solvang Combination for 0.78-mgd Production



Figure 4.8 Buellton DPR AWPf Zoom-Out Site Plan for 0.31-mgd Production

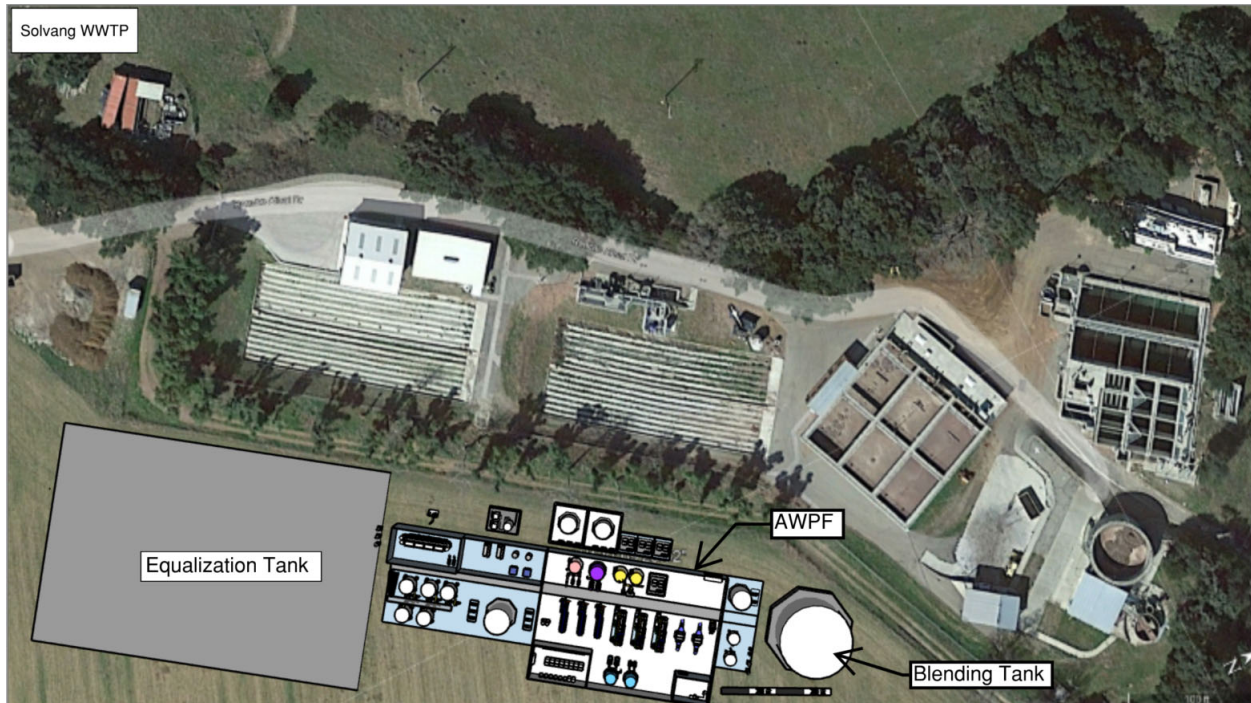

Figure 4.9 Solvang DPR AWPf Zoom-Out Site Plan for 0.71-mgd Production



Figure 4.10 Buellton DPR AWPf Zoom-Out Site Plan of Buellton and Solvang Combination for 0.73-mgd Production

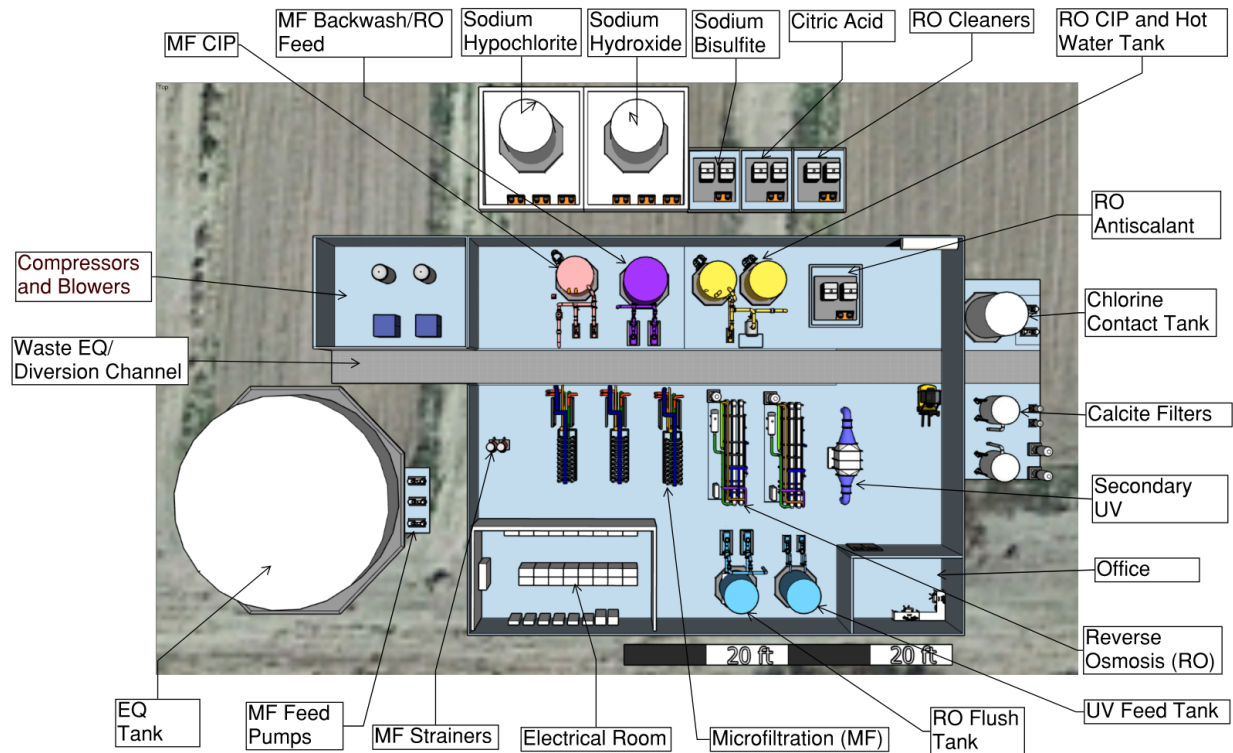

Figure 4.11 Buellton IPR AWPf Zoom-In Site Plan for 0.33-mgd Production

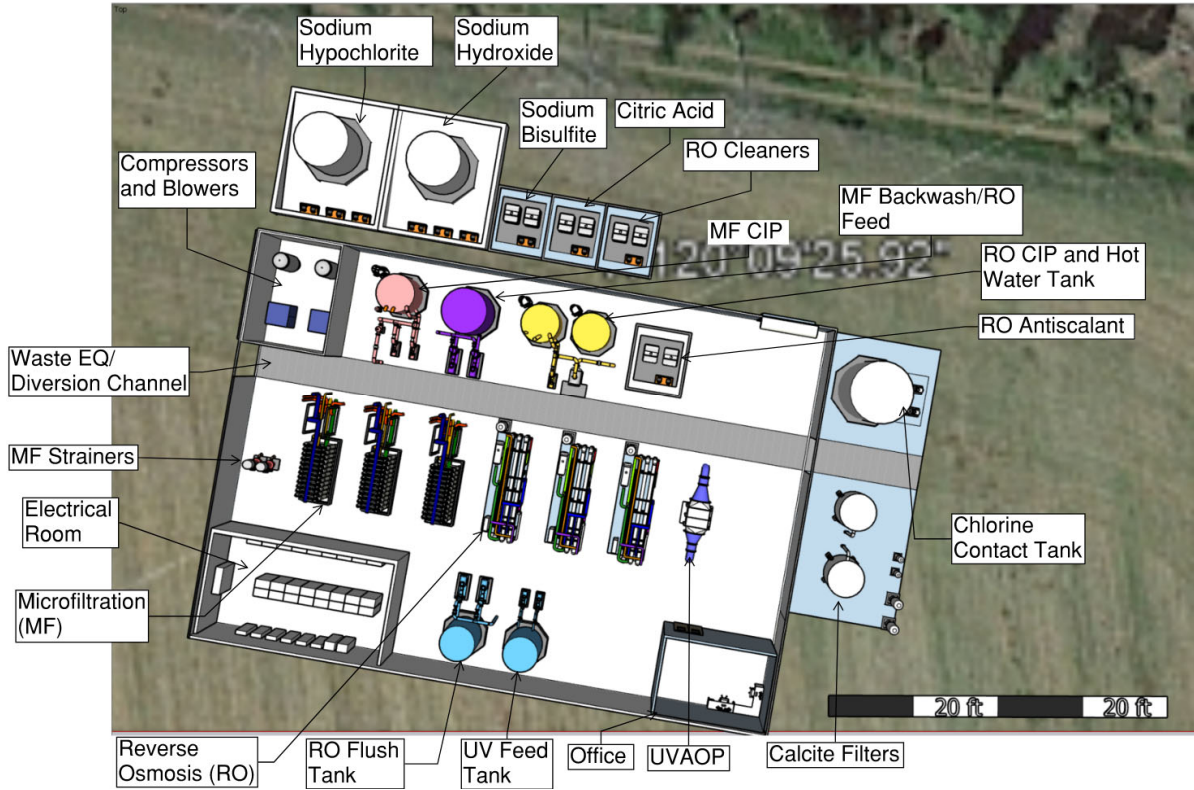

Figure 4.12 Solvang IPR AWP Zoom-In Site Plan for 0.76-mgd Production

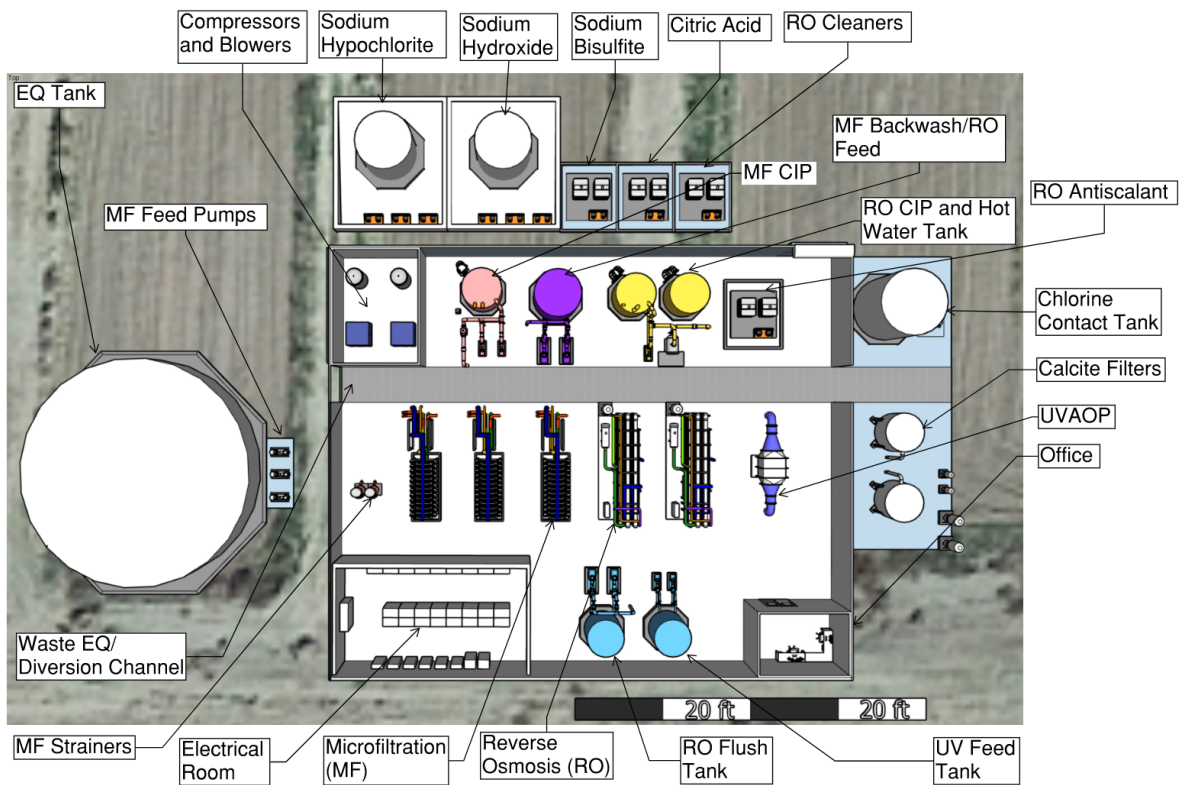

Figure 4.13 IPR AWP Zoom-In Site Plan of Buellton and Solvang Combination for 0.78-mgd Production

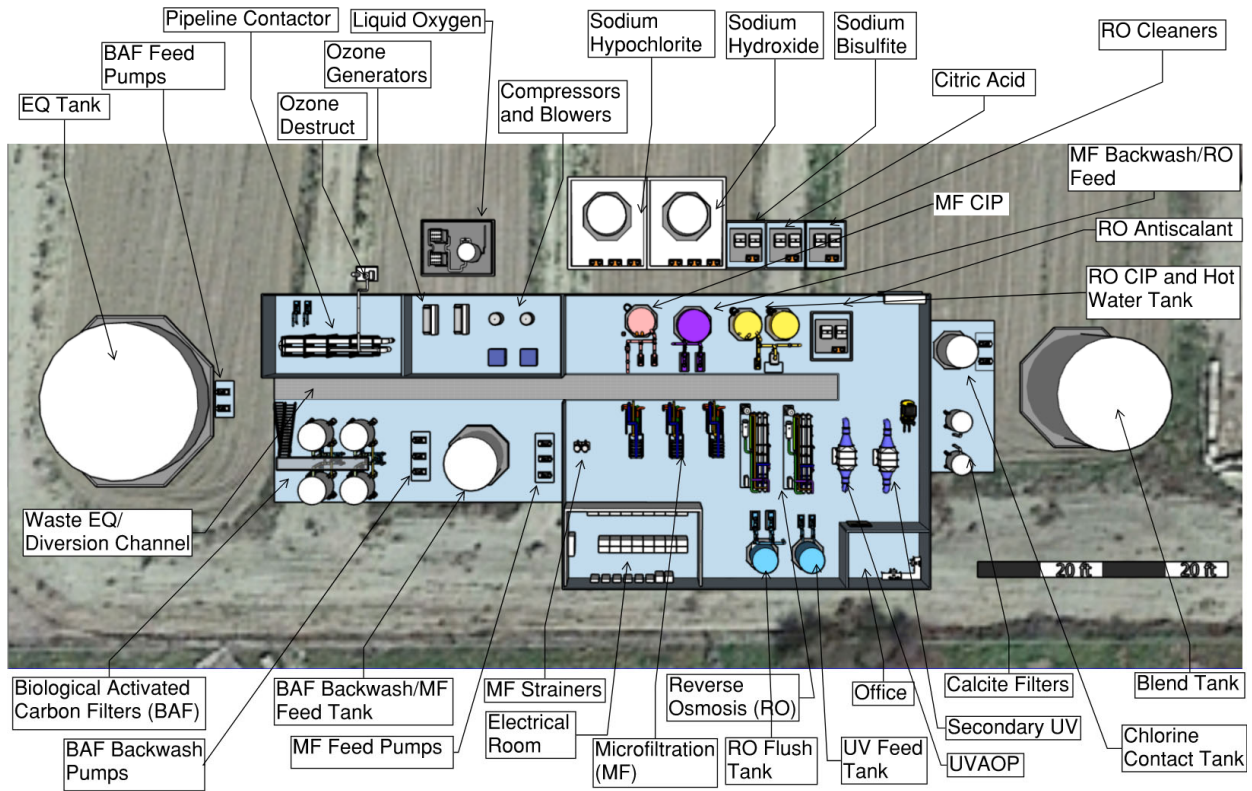

Figure 4.14 Buellton DPR AWP Zoom-In Site Plan for 0.31-mgd Production

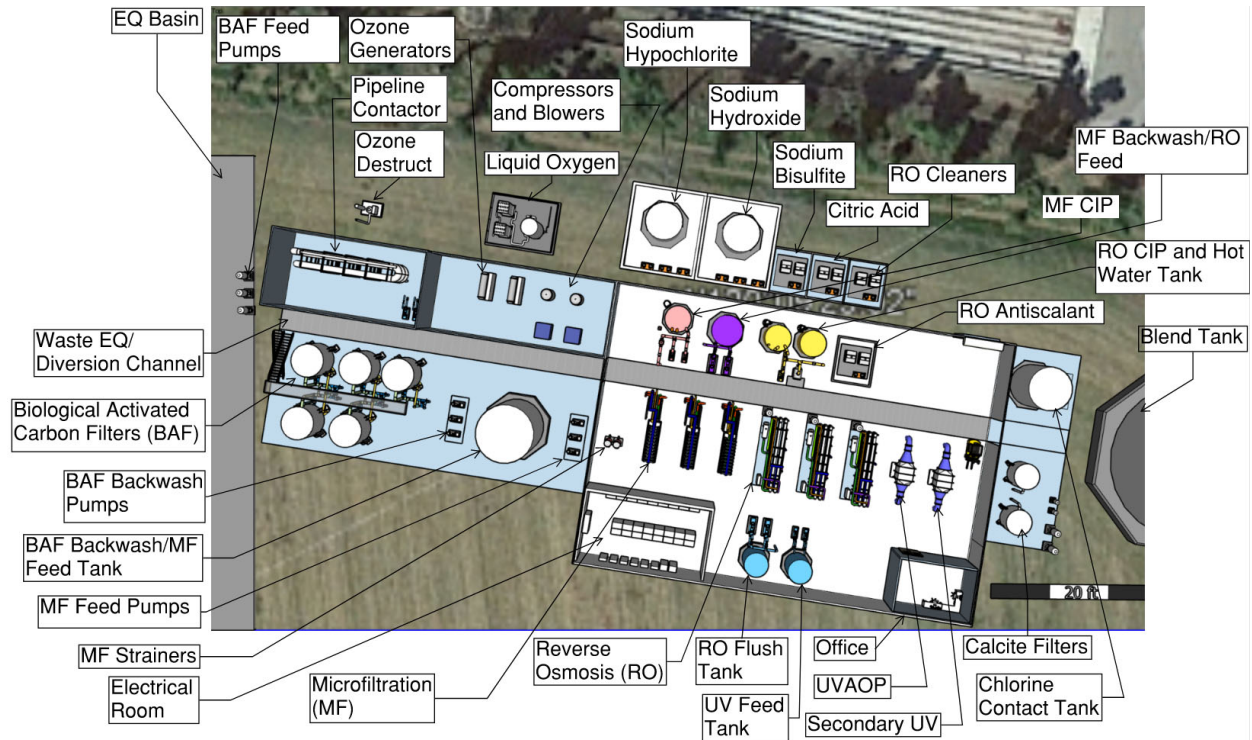

Figure 4.15 Solvang DPR AWP Zoom-In Site Plan for 0.71-mgd Production

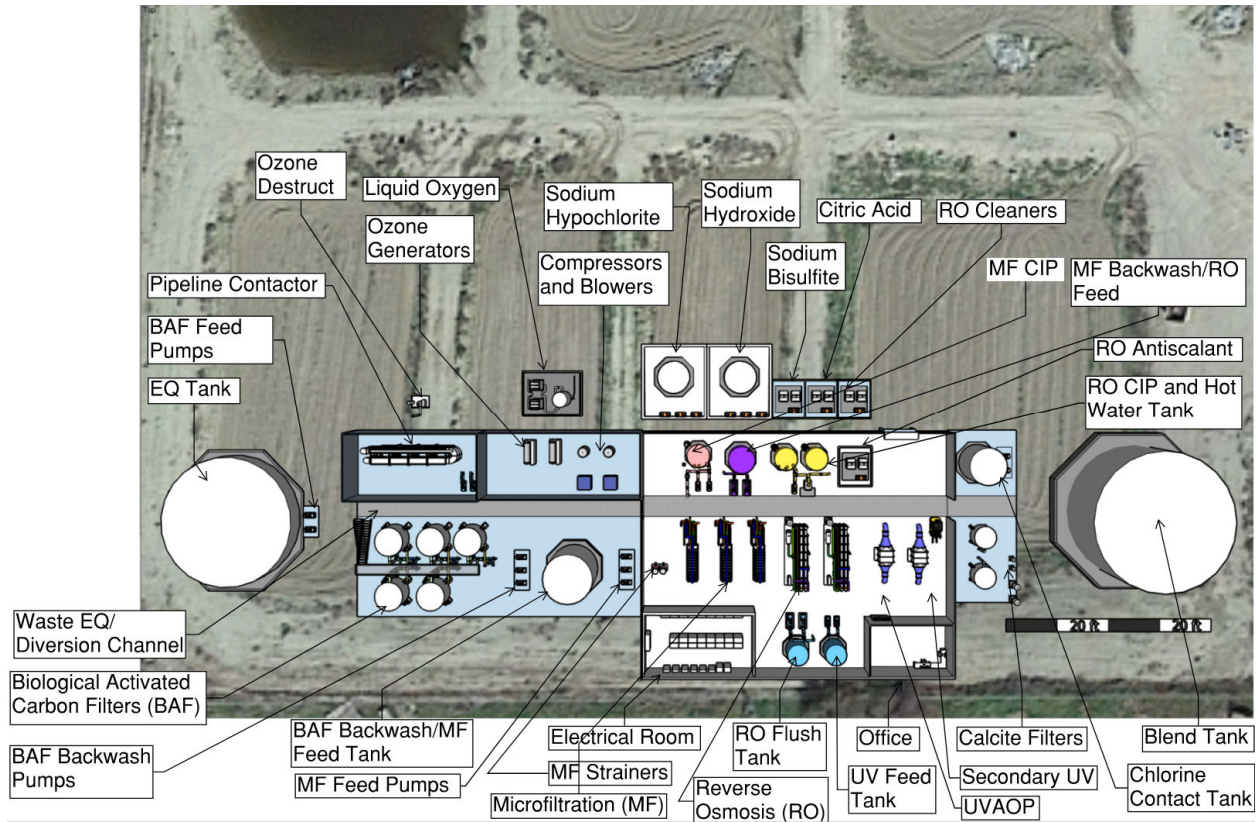

Figure 4.16 Buellton DPR AWP Zoom-In Site Plan of Buellton and Solvang Combination for 0.73-mgd Production

CHAPTER 5 WATER END USE AND NECESSARY INFRASTRUCTURE

5.1 Introduction

This chapter evaluates how the PRW is integrated into the municipal water supply (e.g., groundwater injection or directly into the distribution system) after treatment as well as the corresponding infrastructure required for transport to the end locations.

For this project, filtered undisinfected tertiary effluent from the local WWTPs (City of Buellton and City of Solvang) is routed to two potential AWPFS. The AWPFS at the City of Buellton would be either a 0.43 mgd facility (feed flow) or a 1.02 mgd facility (feed flow) for the combined Solvang/Buellton AWPFS. The AWPFS at the City of Solvang would be a 1.0 mgd facility (feed flow). The PRW would be conveyed either to injection wells for IPR or directly into the potable water distribution system for DPR. The waste flow from these AWPFS, which is the ROC, would be routed to deep well injection.

In addition, this chapter presents a review of the suggested pipe routing and the corresponding pump station(s) essential for the efficient distribution of untreated wastewater from SSD to CSD. Once connected to CSD, the wastewater can be treated and later purified as part of the larger (and currently under design) CAPP.

5.2 End Destination of Purified Recycled Water

As discussed in Chapter 3, there are several options that can be considered in California for potable reuse, including groundwater replenishment (GWR), surface water augmentation (SWA), raw water augmentation (RWA) ahead of a WTP, or treated water augmentation (TWA) (added directly into the drinking water distribution system), which are presented on Figure 5.1. Only GWR and TWA are practically viable for this particular project analysis.

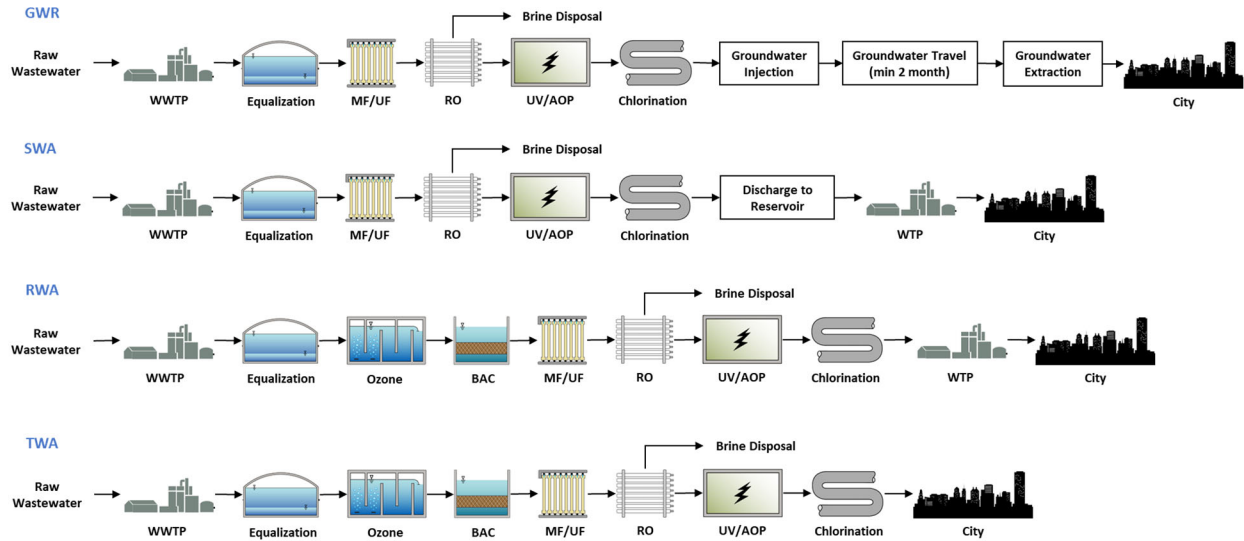

Figure 5.1 Four IPR/DPR Discharge Options

5.2.1 Groundwater Replenishment

As it pertains to this project, GWR is an IPR process that involves injecting PRW into underground aquifers to enhance the natural replenishment of groundwater.¹ At least two months of travel time in the groundwater basin are required to ensure the quality and safety of the injected water. Rigorous monitoring programs are typically involved that include regular sampling and analysis of the groundwater at various points in the aquifer to verify that the water quality meets regulatory and public health standards.

GWR was considered for the IPR projects in Solvang and Buellton. For the purposes of these projects, both 6- and 12-month travel time buffers were considered to provide a conservative estimate of infrastructure required. In addition, GWR is currently being pursued for the CAPP project, where the SSD flows would supplement CSD flows for purification and use.

5.2.2 Surface Water Augmentation

SWA is an IPR process that involves adding PRW to a surface water reservoir for subsequent treatment at a WTP for local supply. Several reservoirs are located in the County, including Lake Cachuma, Gibraltar Reservoir, Jameson Lake, and Twitchell Reservoir. Each reservoir is briefly described below:

- Lake Cachuma** is a large reservoir located in the Santa Ynez Valley. It was created in 1953 with the construction of the Bradbury Dam on the Santa Ynez River and serves as an important source of drinking water for the region. The reservoir has a capacity of approximately 193,000 ac-ft and covers over 3,100 acres when full. Lake Cachuma is a federal reservoir and adding PRW to the lake represents significant permitting challenges with the federal government. Further, water from Lake Cachuma is

¹ Spreading of tertiary recycled water into basins that percolate into the groundwater is allowed in California but requires significant blending water and travel time in the aquifer. Spreading projects are not evaluated in this document.

pumped, transferred, and treated by WTPs owned by the GWD, the City of Santa Barbara, and the MWD. Accordingly, there is no local WTP that would allow utilization of Lake Cachuma for a SWA project for Buellton or Solvang.

- **Gibraltar Reservoir** is a small reservoir that was created in 1920 with the construction of the Gibraltar Dam on the Santa Ynez River and has a capacity of approximately 4,500 ac-ft. Gibraltar Reservoir is located within the mountains to the southeast of Cachuma. The reservoir serves as an important source of drinking water for the City of Santa Barbara and provides recreational opportunities. The location of Gibraltar makes use prohibitive for a SWA for Buellton or Solvang.
- **Jameson Lake** is a small reservoir located in the mountains further to the southeast of Gibraltar. Jameson Lake was created in 1911 with the construction of a small earthen dam and has a capacity of approximately 4,800 ac-ft. Like Gibraltar, the location of Jameson makes use prohibitive for a SWA for Buellton or Solvang.
- **Twitchell Reservoir** is a small reservoir that was created in 1957 with the construction of a small earthen dam on the Cuyama River and has a capacity of approximately 195,000 ac-ft. There is no WTP located at or near Twitchell Reservoir, making SWA infeasible.

For the projects considered as a part of this study none of these existing reservoirs allow for SWA for the analyzed projects.

5.2.3 Raw Water Augmentation

RWA is a DPR project that involves adding PRW into the intake side of a WTP. The County has several WTPs that serve the local communities with safe and clean drinking water. These plants vary in size and capacity and are briefly described below.²

- **William B. Cater WTP:** The Cater WTP in the City of Santa Barbara has a capacity of up to 37 mgd. This plant treats water from Lake Gibraltar and Cachuma, which is a major water source for the area. The plant uses a multi-step treatment process, including screening, flocculation, sedimentation, filtration, and disinfection. The Cater WTP, in addition to being City of Santa Barbara property, is located far from any of the evaluated projects.
- **Corona del Mar WTP:** The Corona del Mar WTP belongs to GWD and has a design capacity of approximately 24 mgd, with a peak capacity of around 36 mgd. Due to its elevation of 192 meters (630 feet), water can be delivered to most of the district customers by gravity flow, without pumping. The plant receives "raw water" from Lake Cachuma and uses a multi-step treatment process, including pretreatment, flash mixing, coagulation/flocculation, sedimentation, filtration, and disinfection, to remove suspended matter and meet state health standards. The Corona del Mar WTP, in addition to being City of Goleta property, is located far from any of the evaluated projects.
- **The City of Lompoc WTP:** The City of Lompoc operates a conventional WTP with processes including disinfection, coagulation, flocculation, sedimentation, and filtration using diatomaceous earth. The WTP has a current capacity up to 10 mgd. The City of Lompoc WTP is located far from any of the evaluated projects.
- **Polonio Pass WTP:** The Polonio Pass WTP, which is operated by the Central Coast Water Authority, has a maximum capacity of 43 mgd. The plant treats all water supplied by the SWP to San Luis Obispo

² <https://www.countyofsb.org/2473/Water-Treatment-Plants>.

and the County. The treatment process at the Polonio Pass WTP involves several stages, including flash mixing, coagulation/flocculation, sedimentation, filtration, and disinfection. Like all other WTPs considered here, the Polonio Pass WTP is located far from the evaluated project sites.

The cities of Buellton and Solvang are located far from any of the WTPs in the County and thus are not amenable for RWA as part of this project.

5.2.4 Treated Water Augmentation

TWA is the process of producing PWR that is directly introduced into the drinking water distribution system. TWA DPR is a viable option for the Buellton and Solvang projects, the new PRW source is proposed to be blended with the cities' existing SWP source. TWA is not evaluated for a SSD project, as the SSD project would combine with CAPP, which is a GWR project.

5.3 Solvang and Buellton Advanced Water Purification Facility Infrastructure

The following subsections detail infrastructure required for the proposed Solvang and Buellton individual AWWPFs as well as the Solvang-Buellton combined AWWPF. These projects could be either IPR (via GWR) or DPR (via TWA). It should be noted that infrastructure presented in this chapter is preliminary and has been sized based on current flow data, as evaluated in Chapter 2. Should any iteration of these projects move forward, further analysis should be performed to evaluate future wastewater flow based on anticipated growth within the service areas.

5.3.1 Advanced Water Purification Facility Feedwater Infrastructure

As both the proposed IPR and DPR AWWPFs for Solvang and Buellton are located adjacent to the existing WWTPs, a short pipeline will convey wastewater effluent from the WWTPs to the EQ basin, followed by another short pipeline to the AWWPF influent. The pipeline for the combination of Solvang and Buellton will convey the wastewater effluent from both the Solvang and Buellton WWTPs to a combined AWWPF located adjacent to the Buellton WWTP. The pipe alignment for the equalized wastewater flow from the Solvang WWTP to the combined AWWPF at Buellton is shown on Figure 5.2. The remaining smaller pipelines are not shown, as these lengths and alignments are short and could change based on final AWWPF siting.



Figure 5.2 AWPFF Feedwater Preliminary Pipe Alignment: Solvang WWTP to Buellton AWPFF Influent

Table 5.1 provides pipeline details for the feedwater pipelines and estimated pumping required for the Solvang, Buellton, and combined AWPFF projects.

Table 5.1 AWPFF Feedwater Pipeline Design Details

Pipe Purpose	Pipe Capacity (mgd)	Pipe Diameter (inches)	Pipeline Length (feet)	Pump Power Demand (hp)
City of Solvang AWPFF (Feed Flow = 1.0 mgd)				
Feed Flow: Wastewater Effluent to EQ Basin ⁽¹⁾	3.6	16	600	(2)
Feed Flow: EQ Basin to AWPFF Influent	1.0	10	300	(2)
City of Buellton AWPFF (Feed Flow = 0.43 mgd)				
Feed Flow: Wastewater Effluent to EQ Basin ⁽¹⁾	1.5	12	250	(2)
Feed Flow: EQ Basin to AWPFF Influent	0.43	6	350	(2)
Combined Solvang/Buellton AWPFF (Feed Flow = 1.02 mgd)				
Feed Flow: Buellton Wastewater Effluent to EQ Basin ⁽¹⁾	1.5	12	250	(2)
Feed Flow: Buellton EQ Basin to AWPFF Influent	0.43	6	350	(2)
Feed Flow: Solvang Wastewater Effluent to EQ Basin ⁽¹⁾	3.6	16	600	(2)
Feed Flow: Solvang EQ Basin to AWPFF Influent	1.0	10	21,200	25

Notes:

- (1) Pipe flow is based on the highest observed daily effluent flow over the available dataset.
- (2) Pump power was not estimated for these interplant pipes. These pipes are small in length. The required pressure and alignment should be refined further should this project move forward into design.

hp - horsepower

5.3.2 Flow Equalization

As discussed in Chapter 2, flow EQ is required for efficient advanced treatment and maximum capture of water for reuse. Flow analysis performed identified EQ basin sizing options to appropriately equalize each city's effluent flow based on the AWPf sizing. As noted, EQ for Solvang will be sized to equalize the entirety of the city's flow, while Buellton EQ will be sized to capture ADWF only.

Table 5.2 shows the anticipated type, volume, and dimensions of the EQ basin for each city. The listed sizes would apply to both the individual and combined projects. As is all the infrastructure presented in this chapter, the sizing of the EQ basins is preliminary and may change based on ultimate AWPf sizing or space available at each site.

Table 5.2 Flow EQ Basin Design Criteria

EQ Basin Location	EQ Basin Type	Dimensions (feet)	Height/Depth (feet)	Approximate Total Volume (gallons)
Solvang	Rectangular Earthen Basin	Length = 240 Width = 160	15	4,300,000
Buellton	Steel Circular Storage Tank	Diameter = 48	13	140,000

As discussed previously, permitting negotiations are successful, and it is not required to capture and equalize all of the PWWF, then the large EQ basin could be removed (or significantly decreased in size) from the project and the size of the AWPf facility could also decrease.

5.3.3 Advanced Water Purification Facility Finished Water Infrastructure

After purification, finished water will be conveyed from the AWPf to delivery points, either to proposed injection wells (IPR scenario) or for direct connection to individual city distribution systems (DPR scenario). Each scenario, and required infrastructure, is discussed in the sections below.

5.3.3.1 Groundwater Augmentation for Indirect Potable Reuse

Treated water from both IPR AWPfs would be injected into the underlying groundwater basin for subsequent uptake and use by the city's water supply wells. As noted in Chapter 3, a minimum of two months of travel time is required from the IPR injection wells to the nearest potable water supply wells. A number of well data sources were reviewed to understand the quantity and density of potable water supply wells within both cities. The following data sources were reviewed:

- **County well records:** Table (as of September 30, 2022) of active and approved wells permitted by the County.
- **Groundwater Sustainability Plan (GSP) well maps:** Mapped well locations and types compiled by the Eastern Management GSP³ (covering the groundwater basin underlying the City of Solvang) and

³ GSI Water Solutions, Inc., 2022. Santa Ynez River Valley Groundwater Basin – Eastern Management Area Groundwater Sustainability Plan, January 2022. <https://www.santaynezwater.org/eastern-management-area-groundwater-sustainability-plan-2df1d8b>.

Central Management GSP⁴ (covering the groundwater basin underlying the City of Buellton). Note that actual spatial well data was not available for this project, so figures provided were reviewed.

- **SYRWCD well maps:** Well location data compiled by the SYRWCD. Note that well type or status (active versus inactive) was not available.
- **City municipal wells:** Well locations for city-owned municipal wells.

Due to the different nature and level of detail of well data available, it was difficult to directly correlate well locations across datasets. Thus, for the purposes of this evaluation, active city municipal well locations were primarily considered when siting the IPR injection wells. Should this type of project proceed into implementation, it is recommended a more detailed water supply well survey be conducted prior to finalizing the injection well locations.

Appendix D details the evaluation that was completed to determine the anticipated groundwater travel time. To be conservative at this preliminary planning phase, 6-month and 12-month travel times were developed for the underlying groundwater basins in each city. As a reminder, the State of California requires a minimum travel time of two months. Table 5.3 shows the estimated 6- and 12-month travel time for Solvang and Buellton.

Table 5.3 Estimated Groundwater Travel Times

City	6-Month Travel Time (feet)	12-Month Travel Time (feet)
Solvang	1,100	2,300
Buellton ⁽¹⁾	2,700	5,400

Notes:

- (1) As discussed in Appendix D, there are two different aquifer formations underlying the City of Buellton—the shallower Paso Robles formation and the deeper Careaga/Graciosa formation. Travel times shown are for the Careaga/Graciosa formation as the estimated depth of this portion as this is a more conservative travel time estimate and is a closer depth to where the nearby City of Buellton well is screened.

These travel time buffers were applied to selected city wells that were screened to a similar depth as the anticipated injection wells. This analysis allows the project team to site the IPR injection wells outside of these buffers. Figure 5.3 and Figure 5.4 show the city municipal wells, SYRWCD wells (for reference only), 6- and 12-month buffers applied to selected city wells and potential injection locations (for each buffer). The selected municipal wells were those that were screened to a similar depth as the anticipated IPR injection, to consider the different aquifer formations present. For example, in both cities, the active municipal wells along the Santa Ynez River were not considered, as these wells are comparatively shallow and unlikely to interact with the injected PRW.

It should be noted that there was no property evaluation performed for the identified injection well locations. Location and property availability will need to be assessed should this project move forward.

Indirect Potable Reuse Finished Water Infrastructure

Table 5.4 provides pipeline details for the finished water pipelines and estimated pumping required for the Solvang, Buellton, and combined AWPf projects.

⁴ Stetson Engineers Inc., 2022. Santa Ynez River Valley Groundwater Basin – Central Management Area Groundwater Sustainability Plan, January 2022. <https://www.santaynezwater.org/central-management-area-groundwater-sustainability-plan-b1412d9>.

Table 5.4 AWPf IPR Finished Water Pipeline Design Details

Pipe Purpose	Pipe Capacity (mgd)	Pipe Diameter (inches)	Pipeline Length (feet)	Pump Power Demand (hp)
City of Solvang AWPf (Feed Flow = 1.0 mgd)				
Finished Water Flow: To Solvang 6-month Injection Site	0.76	8	6,200	60
Finished Water Flow: To Solvang 12-month Injection Site	0.76	8	10,300	
City of Buellton AWPf (Feed Flow = 0.43 mgd)				
Finished Water Flow: To Buellton 6-month Injection Site	0.33	6	6,600	25
Finished Water Flow: To Buellton 12-month Injection Site	0.33	6	11,500	
Combined Solvang/Buellton AWPf (Feed Flow = 1.02 mgd)				
Finished Water Flow: Combined Finished Water Pipe	0.78	8	3,300	125
Finished Water Flow: To Solvang 6-month Injection Site	0.45 ⁽¹⁾	6	17,600	
Finished Water Flow: To Solvang 12-month Injection Site	0.45 ⁽¹⁾	6	21,900	
Finished Water Flow: To Buellton 6-month Injection Site	0.33 ⁽¹⁾	6	3,300	
Finished Water Flow: To Buellton 12-month Injection Site	0.33 ⁽¹⁾	6	8,100	

Notes:

(1) Finished water flow to Solvang and Buellton at the combined AWPf is the fraction of ADWF contributed by both cities with IPR treatment losses applied.

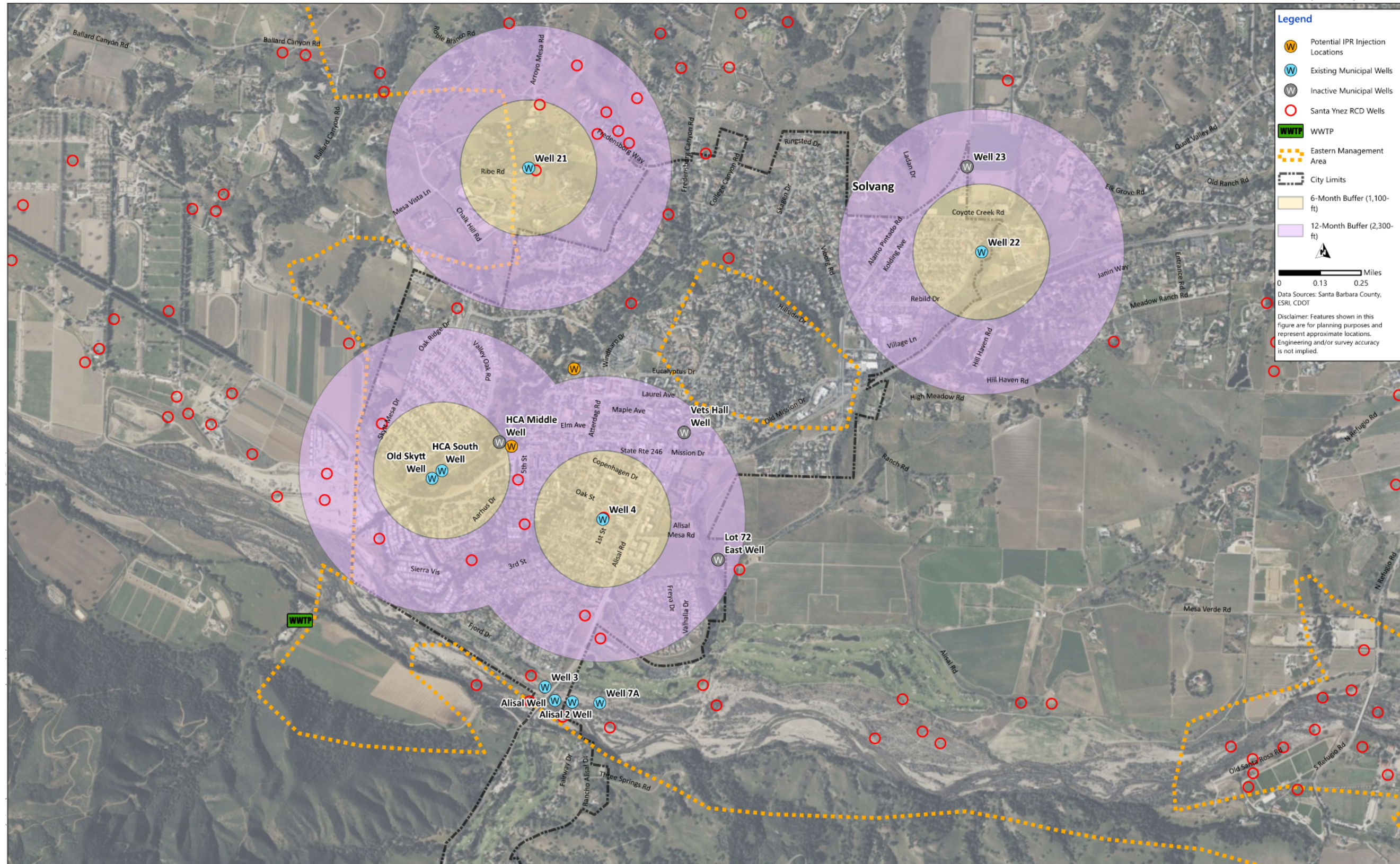

Figure 5.3 Solvang IPR Preliminary Injection Well Siting

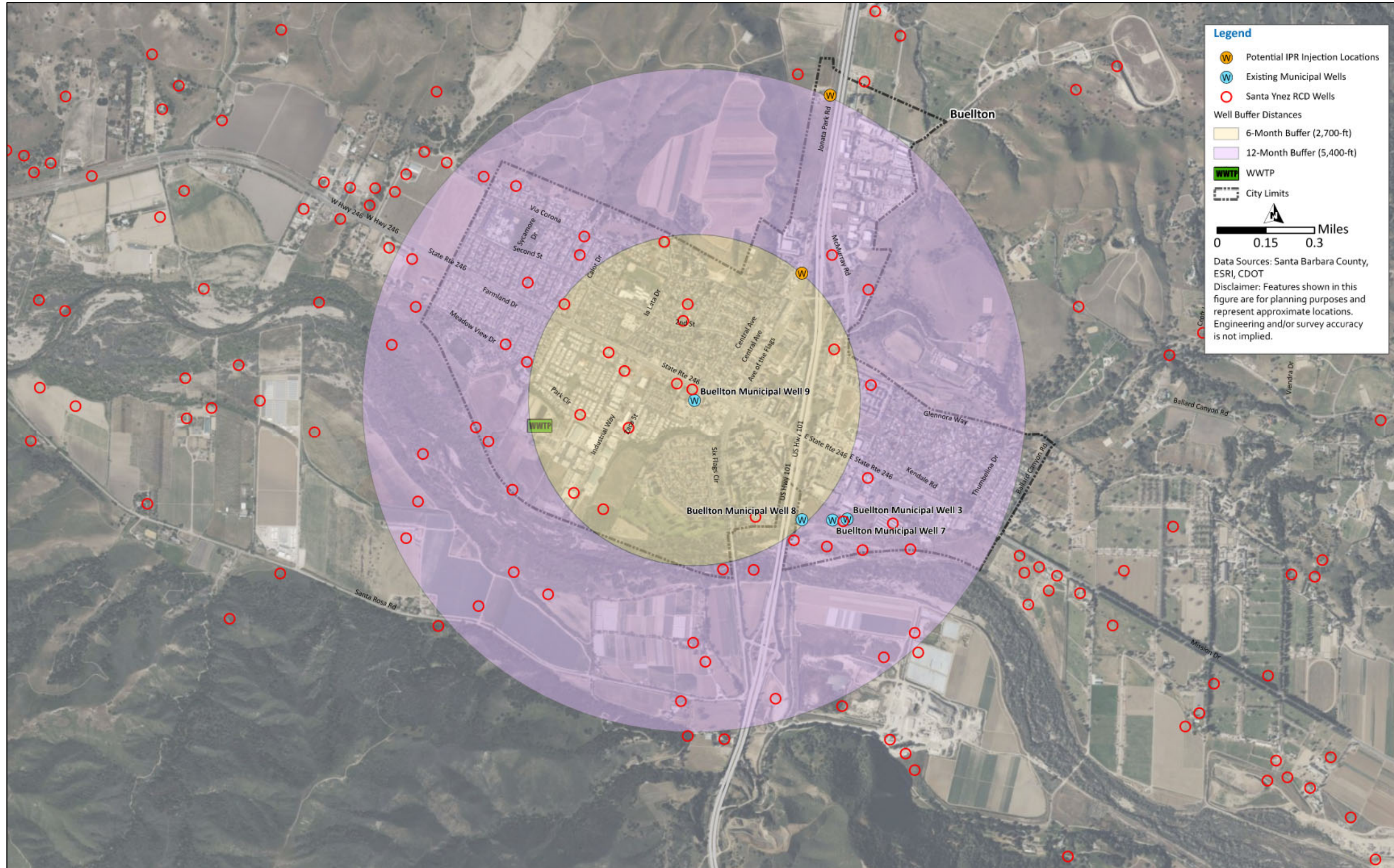

Figure 5.4 Buellton IPR Preliminary Injection Well Siting

Table 5.5 provides design details for the quantity of injection wells required at the Solvang and Buellton injection sites. Injection well quantity was determined by a review of the capacity of the nearby municipal water supply wells. It was assumed that the rate of injection was approximately half of the rate if extraction from the supply wells (as noted in Table 5.5).

Table 5.5 Injection Well Design Criteria

Injection Well Site	Capacity Required ⁽¹⁾ (mgd)	Capacity Required (gpm)	Injection Capacity, per Well (gpm)	Number of Injection Wells Needed
Solvang	0.76	556	200 ⁽²⁾	3 + 1 ⁽³⁾
Buellton	0.33	236	425 ⁽⁴⁾	1

Notes:

- (1) Capacity required is the estimated finished water produced after the IPR treatment losses, see Chapter 4 for more information.
- (2) Injection capacity is estimated as approximately half of the design extraction rate of the Solvang Municipal Well No. 21 and the Solvang Municipal Well HCA South, based on City records.
- (3) One redundant well will be provided at the City of Solvang injection well site to provide redundancy for the Solvang and combined facility should an injection well need maintenance or to be taken offline for routing cleaning. Should the well be offline in Buellton for the Buellton-only project, the AWPf can be shut down and WWTP effluent can be discharged in existing percolation ponds.
- (4) Injection capacity is estimated as approximately half of the design extraction rate of the Buellton Municipal Well No. 9, based on City records.

gpm - gallons per minute

Figure 5.5, Figure 5.6, and Figure 5.7 show the pipeline alignment for the finished water piping to the injection sites for the three AWPf considered.

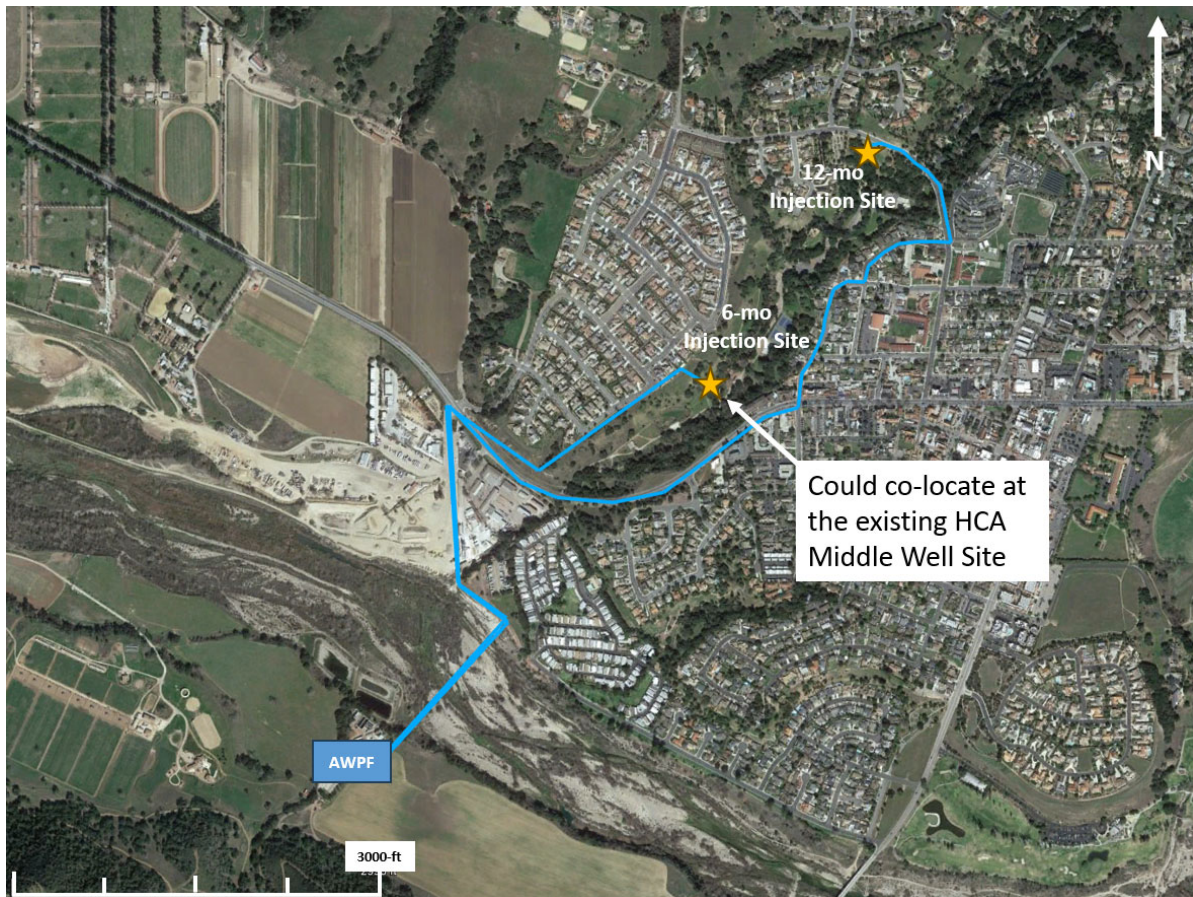

Figure 5.5 Solvang IPR Injection Well Preliminary Pipe Alignment

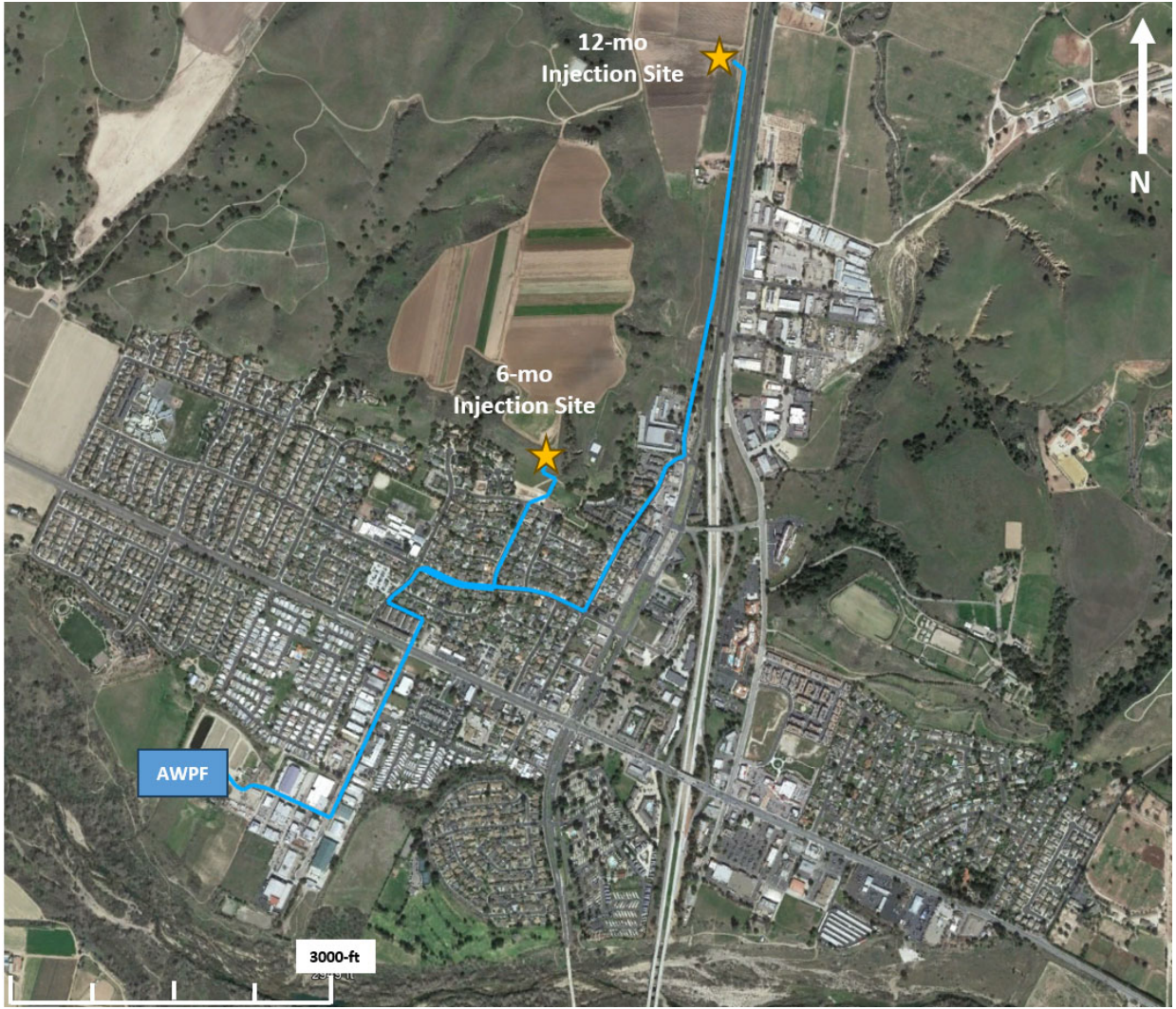

Figure 5.6 Buellton IPR Injection Well Preliminary Pipe Alignment



Figure 5.7 Combined Solvang/Buellton AWPf IPR Injection Well Preliminary Pipe Alignment

5.3.3.2 Treated Water Augmentation for Direct Potable Reuse

Treated water produced from the DPR AWPf's would be directly piped to the existing water distribution system within Solvang and Buellton. As discussed in Chapter 2, both cities primarily receive potable water from the SWP and from the underlying groundwater. The DPR connection points are located generally near each city's respective SWP turnout, the primary pipeline where SWP water is entering the distribution system. Pipe sizing and approximate pressure for the two connection points are provided in Table 5.6. Figure 5.8 and Figure 5.9 show the respective cities' potable water distribution systems and identified connection points.

Table 5.6 SWP Connection Points

SWP Connection Site	SWP Pipe Diameter (inches)	SWP Approximate Pipe Pressure (psi)
Solvang	8	107
Buellton	8	44

Notes:
 psi - pounds per square inch

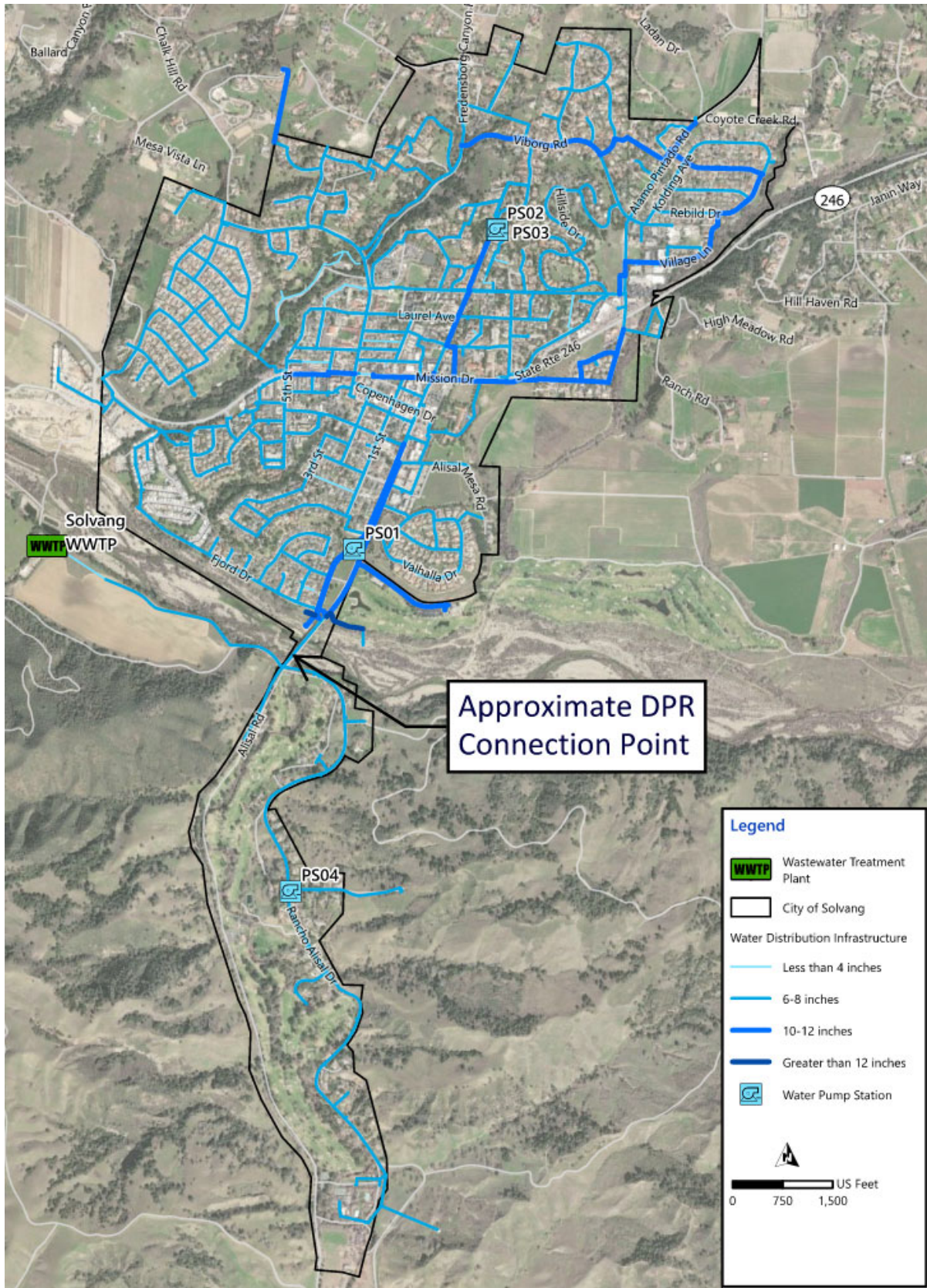

Figure 5.8 Solvang Water Distribution System

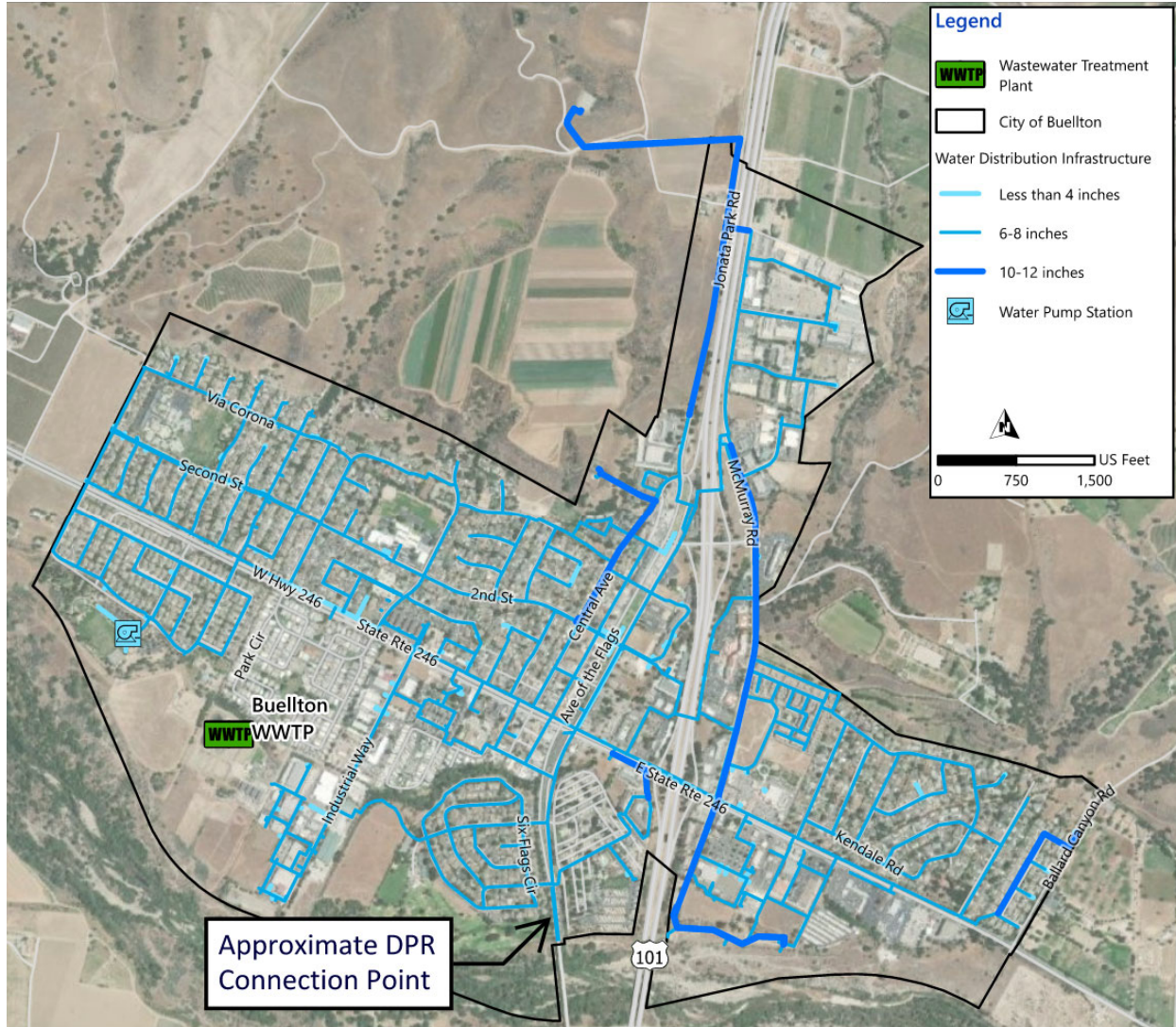

Figure 5.9 Buellton Water Distribution System

As discussed previously, draft DPR regulations require that prior to delivery to the end user (in this case, connection to the SWP pipeline), the water system must provide a 10:1 dilution to attenuate a one-hour peak flow. Such dilution can be achieved at any single or combination of locations along the flow schematic. For this analysis, it is assumed a blending tank will be constructed at the AWPf sites for each scenario to provide this full 10:1 dilution.

Direct Potable Reuse Finished Water Infrastructure

Table 5.7 provides pipeline details for the finished water pipelines and estimated pumping required for the Solvang, Buellton, and combined AWPf projects.

Table 5.7 AWPf DPR Finished Water Pipeline Design Details

Pipe Purpose	Pipe Capacity (mgd)	Pipe Diameter (inches)	Pipeline Length (feet)	Pump Power Demand (hp)
City of Solvang AWPf (Feed Flow = 1.0 mgd)				
To Solvang SWP Connection	0.71	8	4,200	50
City of Buellton AWPf (Feed Flow = 0.43 mgd)				
To Buellton SWP Connection	0.31	6	7,000	15
Combined Solvang/Buellton AWPf (Feed Flow = 1.02 mgd)				
Combined Finished Water Pipe	0.73	8	4,900	75
To Solvang SWP Connection	0.42 ⁽¹⁾	6	19,800	
To Buellton SWP Connection	0.31 ⁽¹⁾	6	2,000	

Notes:

(1) Finished water flow to Solvang and Buellton at the combined AWPf is the fraction of ADWF contributed by both cities with DPR treatment losses applied.

Figure 5.10, Figure 5.11, and Figure 5.12 show the pipeline alignment for the finished water piping to the SWP connection points for the three AWPfs considered.

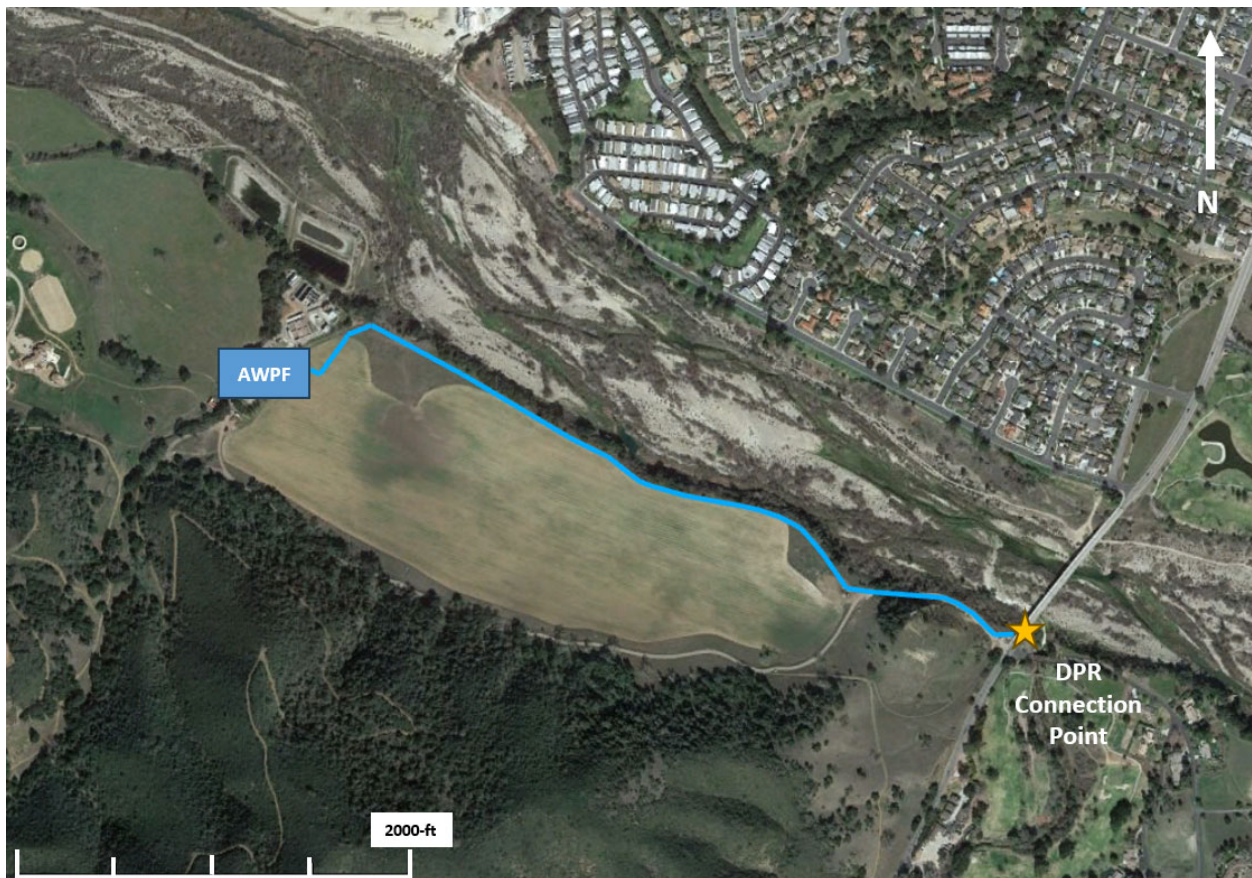

Figure 5.10 Solvang DPR Finished Water Preliminary Pipe Alignment

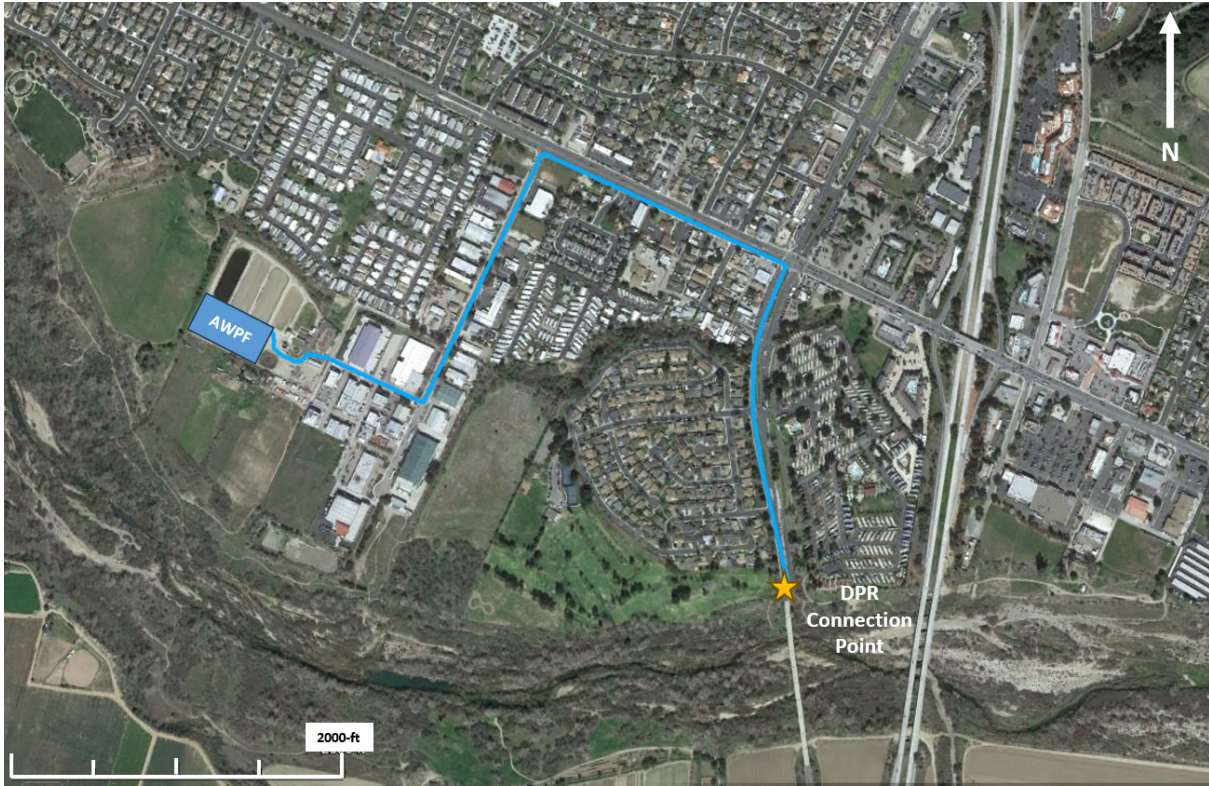

Figure 5.11 Buellton DPR Finished Water Preliminary Pipe Alignment

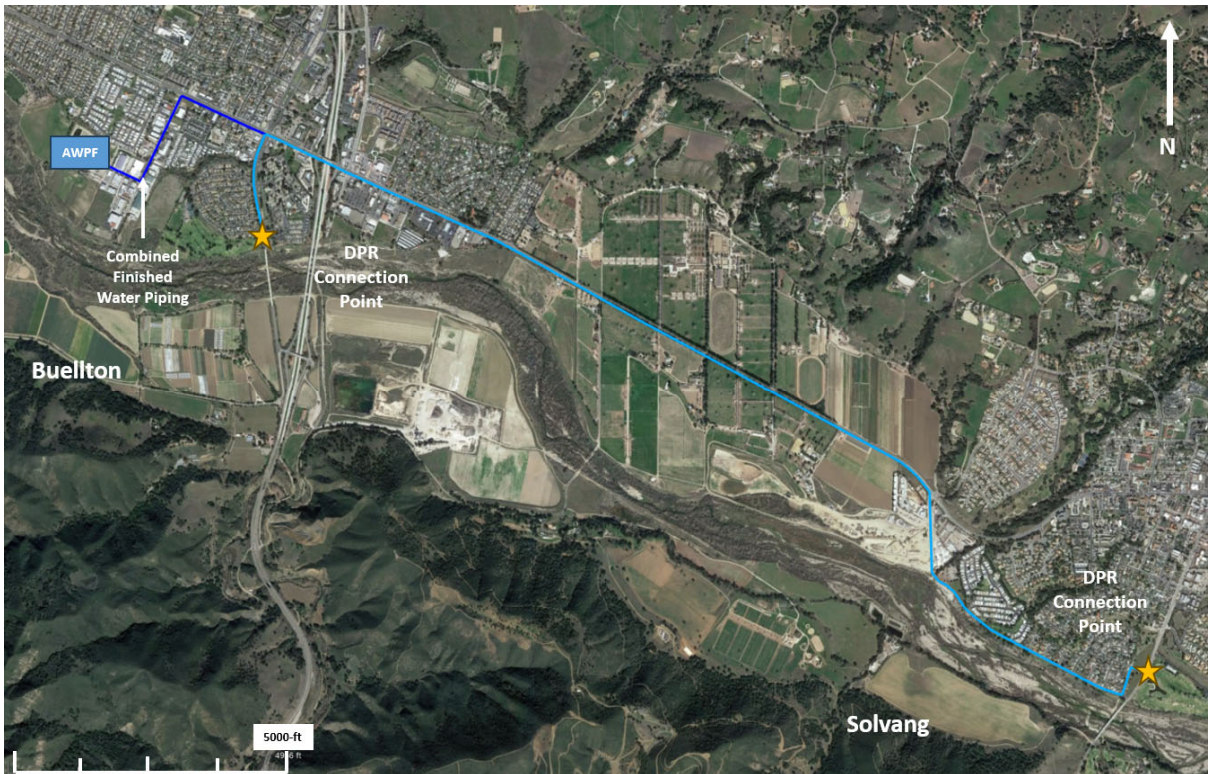

Figure 5.12 Combined Solvang/Buellton AWP DPR Preliminary Pipe Alignment

As noted, DPR projects require a 10:1 dilution of the peak hour flow. This dilution can occur anywhere within the transportation and treatment processes. The dilution credit can be cumulative, incorporating dilution at different locations. The dilution credit must be calculated based upon the peak flow at each particular location.

For this project, the full 10:1 dilution required would be obtained in finished water tanks after EQ and treatment. The sizes of these tanks would be calculated by multiplying the peak production flow by 10 and including a conservative baffling factor of 25 percent in the finished water tank, resulting in the following sizes, shown in Table 5.8.

Table 5.8 Blend Tank Design Criteria

Project	Peak Finished Water Flow (mgd)	Blend Tank Volume (gallons)
City of Solvang	0.76	440,000
City of Buellton	0.31	180,000
Combined Solvang/Buellton	0.78	450,000

For a future project, these tanks sizes could be reduced through a detailed evaluation of other locations within the wastewater transportation and treatment train for dilution credit.

5.3.4 Reverse Osmosis Concentrate Infrastructure

As discussed in Chapter 6, ROC will be conveyed to the identified deep well injection sites in Solvang and Buellton, respectively. Pipeline design criteria are provided in Table 5.9. Figure 5.13 shows the pipe alignment to the Solvang ROC injection site. The Buellton ROC injection is anticipated to be located at or near the WWTP site based on findings in Chapter 6, so this alignment is not shown.

Table 5.9 ROC Deep Well Injection Pipeline Design Details

Pipe Purpose	Flow (mgd) ⁽²⁾	Pipe Diameter (inches)	Pipeline Length (feet)	Pump Power Demand (hp)
City of Solvang AWPf (Feed Flow = 1.0 mgd)				
ROC to Solvang Deep Well Injection Site	0.20	6	12,400	25
City of Buellton AWPf (Feed Flow = 0.43 mgd)				
ROC to Buellton Deep Well Injection Site	0.09	4	900	⁽³⁾
Combined Solvang/Buellton AWPf (Feed Flow = 1.02 mgd)				
ROC to Buellton Deep Well Injection Site ⁽¹⁾	0.20	6	900	⁽³⁾

Notes:

- (1) All ROC will be conveyed to the Buellton injection site for the combined Solvang/Buellton project.
- (2) ROC flow is currently estimated as approximately 20 percent of the feed flow based on typical RO process assumptions. The feed flow + ROC flow does not equal the finished water flow due to additional filtration losses from other treatment processes (the BAC and UF).
- (3) Pump power was not estimated for this pipeline. While there will likely be a small amount of pumping required for deep well injection, this pipeline is short and should be refined should design move forward.

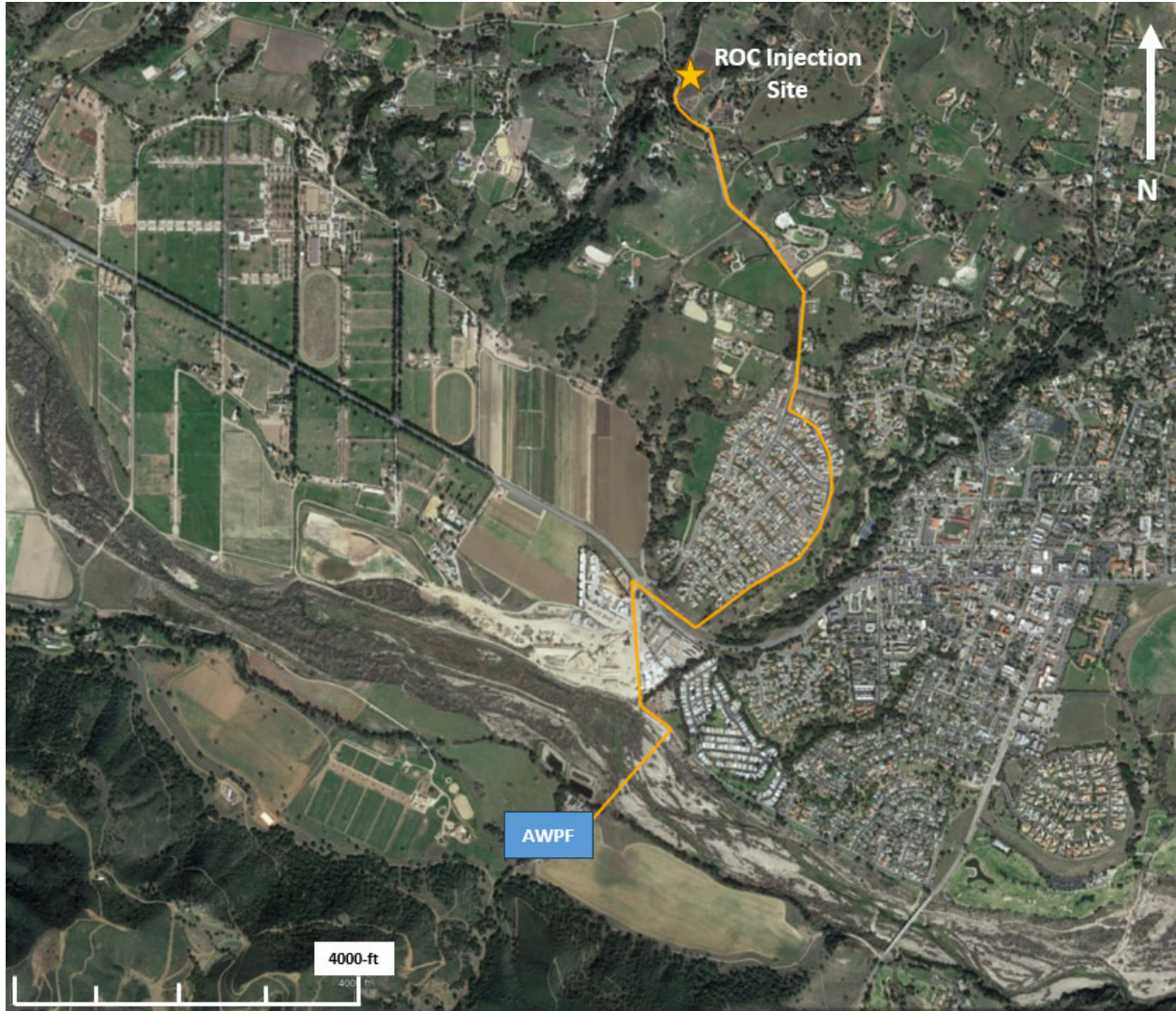

Figure 5.13 Solvang ROC Preliminary Pipe Alignment to Deep Well Injection Site

Each of the deep well injection sites will have two wells in total to provide redundancy. Design criteria is provided in Table 5.10.

Table 5.10 Deep Well Injection Design Criteria

Project	ROC Flow (mgd)	Number of Wells
City of Solvang	0.20	1+1
City of Buellton	0.09	1+1
Combined Solvang/Buellton ⁽¹⁾	0.20	1+1

Notes:

(1) All ROC will be conveyed to the Buellton injection site for the combined Solvang/Buellton project.

5.3.5 Advanced Water Purification Facility Waste/Backwash Return Infrastructure

A single pipeline will convey backwash and other waste flow from the AWPf back to the respective WWTPs. For IPR scenario, the primary source of backwash flow is the UF treatment process while the primary sources of backwash flow for DPR scenario are the UF and BAC treatment processes. Other waste flows include neutralized CIP wastes, UF strainer backwash waste, online analyzer drain wastes, and “flush” wastes from all membrane processes. The combined wastes for both IPR and DPR scenarios are routed to “waste EQ” basin with a combined air gap structure, allowing the combined backwash to be pumped at a constant rate. The waste EQ basin for all IPR and DPR scenarios analyzed will be conservatively sized at 100,000 gallons.

In addition to backwash flow and other waste flows, any water identified to be off-spec during AWPf operation will need to be conveyed back to the WWTP sewer lines. Off-spec flows are assumed to be redirected after either the BAC (DPR scenario only) or RO treatment steps and conveyed via an air gap structure and return flow pumps. The size of the waste/backwash return piping is dictated by the largest flow rate through a single treatment process train in the AWPf plus the anticipated flows from the backwashing and cleaning processes. In both the IPR and DPR treatment processes, the flow rate of a single RO train is the largest single train flow rate, and thus dictates the sizing for the waste/backwash return pipeline. Pipeline design details are provided in Table 5.11. Pipeline alignments are not shown, as these lengths and alignments are short and could change based on final AWPf siting.

Table 5.11 AWPf Waste/Backwash Pipeline Design Details

Pipe Purpose	Flow (mgd)	Pipe Diameter (inches)	Pipeline Length (feet)
City of Solvang AWPf (Feed Flow = 1.0 mgd)			
Solvang IPR Waste/Backwash Return Pipe	1.05	8	800
Solvang DPR Waste/Backwash Return Pipe	0.98	8	800
City of Buellton AWPf (Feed Flow = 0.43 mgd)			
Buellton IPR Waste/Backwash Return Pipe	0.45	6	500
Buellton DPR Waste/Backwash Return Pipe	0.43	6	500
Combined Solvang/Buellton AWPf (Feed Flow = 1.02 mgd)			
Buellton IPR Waste/Backwash Return Pipe ⁽¹⁾	1.07	8	500
Buellton DPR Waste/Backwash Return Pipe ⁽¹⁾	1.01	8	500

Notes:

(1) All waste flows and backwash will be conveyed to the Buellton WWTP for the combined Solvang/Buellton project.

5.4 Summerland Sanitary District Infrastructure

The following subsections detail the infrastructure needed to transport raw wastewater from the existing SSD system to the CSD WWTP for treatment and subsequent advanced treatment as a part of the planned CAPP project.

5.4.1 Existing Carpinteria Sanitary District Collection System

As a part of this project, the existing hydraulic model of the CSD wastewater collection system was analyzed to understand the impacts of adding in the range of SSD wastewater flows from 0.2 mgd (representing the minimum equalized flow that can be accommodated) to 0.54 mgd (maximum observed non-equalized peak flow). Such an analysis allows for a better understanding of the anticipated CSD system challenges as well as points that additional wastewater flow could be added in.

The CSD system consists of approximately 40 miles of gravity main piping and 8 miles of force main piping. Pipes range in size from 21- to 4-inches in diameter. The collection system includes eight total lift stations. Figure 5.14 shows the CSD system.

Conversations with CSD staff indicated that Lift Stations No. 2 and No. 4 are already challenged under existing wet weather flows. It is likely both lift stations will need to be upgraded with larger pumps if SSD flow is added upstream of these lift stations. CSD staff also indicated that the WWTP is equipped to take all the SSD flow (up to anticipated peak flows) and their main concern is collection system bottlenecks that would occur due to the added flows from SSD.

5.4.2 Summerland Sanitary District Raw Wastewater Piping

A new pipeline will be constructed to transport raw wastewater from the SSD WWTP site to the identified connection points in the CSD system. As discussed in Chapter 2, equalized flows from 0.1 mgd to 0.47 mgd were assessed based on available flow data. For the purposes of required infrastructure, two flows rates were assumed as options for connecting to the CSD system:

- **0.2 mgd:** Represents the largest possible EQ basin size that can feasibly be constructed at the SSD WWTP site (see Section 0 for further EQ basin discussion).
- **0.47 mgd:** Represents the equalized flow possible from utilizing the existing 70,000-gallon EQ basin at the SSD WWTP site. This minimum level of EQ may not be acceptable to CSD.

Table 5.12 presents anticipated sizing and design criteria for the raw wastewater pipeline options as well as pump power requirements. The specific alignment of the pipeline is illustrated on Figure 5.15.

Table 5.12 Untreated Wastewater Feedwater Design Details

Pipe Flow (mgd)	Pipeline Length (miles)	Pipeline Length (feet)	Pipe Diameter (inches)	Pump Power Demand (hp)
0.2	3.12	16,500	6	5
0.47	4.29	22,600	6	40



Figure 5.14 CSD Wastewater Collection System

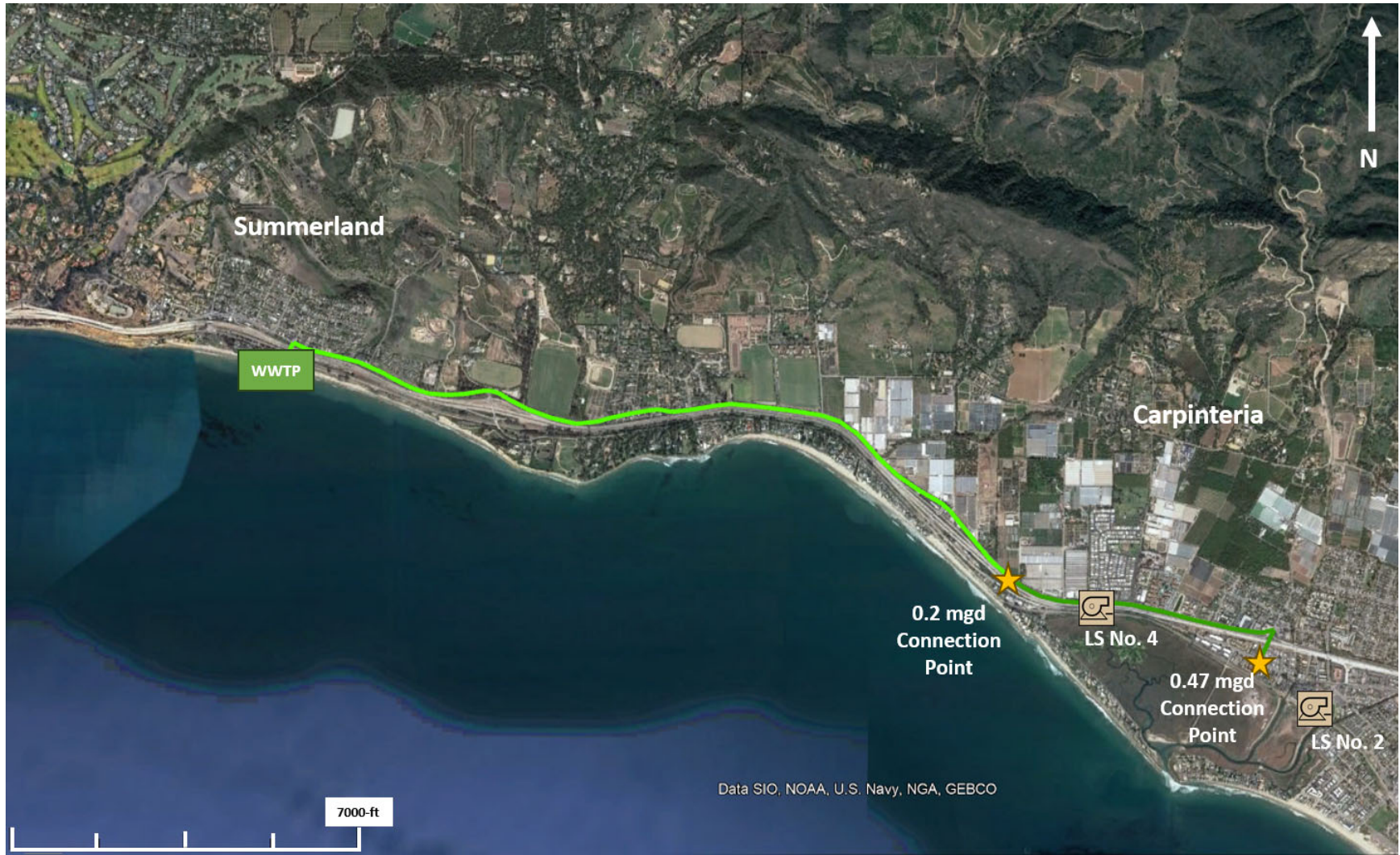

Figure 5.15 Untreated Wastewater Feedwater Preliminary Pipe Alignment From SSD to CSD

As shown on Figure 5.15, the 0.2 mgd connection point is located upstream of the two lift stations that CSD indicated may be capacity deficient (Lift Station No. 4 and No. 2) and the 0.47 mgd connection point is upstream of one of the deficient lift stations (Lift Station No. 2). Based on the CSD collection system model, the lift station pump design criteria are shown in Table 5.13.

Table 5.13 Lift Station No. 2 and No. 4 Existing Capacity

Lift Station	No. Pumps	Design Flow (mgd)	Existing Peak Hourly Flow (mgd) ⁽¹⁾	Capacity Deficient?
Lift Station No. 4	1+1	1.14	0.59	No
Lift Station No. 2	1+1	0.79	1.23	Yes

Notes:

(1) Existing flow is PWWF without any added SSD flow.

The 0.2 mgd and 0.47 mgd flows were input into the model to assess the impacts to these existing lift stations. The following capacity deficiencies were noted as shown in Table 5.14.

Table 5.14 Lift Station No. 2 and No. 4 Capacity With Added SSD Flows

Flow Added (mgd)	Lift Station No. 4		Lift Station No. 2	
	New Peak Hourly Flow (mgd)	Capacity Deficient?	New Peak Hourly Flow (mgd)	Capacity Deficient?
0.2	0.79	No	1.43	Yes
0.47	0.59	(1)	1.71	Yes

Notes:

(1) The 0.47 mgd flow will be added downstream of Lift Station No. 4. Therefore, no flow change from the existing conditions is anticipated.

As noted, based on this preliminary analysis, Lift Station No. 4 has sufficient capacity while Lift Station No. 2 has capacity deficiencies in all flow scenarios, including at existing flows. For the purposes of this analysis, it is recommended that additional pump(s) be installed at Lift Station No. 2 of the same capacity as the existing installed pumps. It is recommended that variable frequency drives be installed on the new pumps. Lift station upgrades for Lift Station No. 2 are shown in Table 5.15.

Table 5.15 Lift Station No. 2 Capacity Upgrades

Flow Added (mgd)	No. Pumps	Capacity Required (mgd)	New Capacity (mgd)
0.2	2+1	1.43	1.58
0.47	3+1	1.71	2.37

The resulting increase in flows and upsizing of Lift Station No. 2 may require upsizing portions of the existing CSD gravity main piping. Based on discussions with CSD, the maximum depth to diameter ratio (d/D) within the collection system is 0.92 based on typical values in similar systems. Figure 5.16 and Figure 5.17 show the locations of pipe in both flow scenarios where d/D exceeds 0.92 and Table 5.16 and Table 5.17 show the anticipated feet of replacement that would be required, at a minimum.



Figure 5.16 Modeled Gravity Mains Exceeding $d/D = 0.92$ (0.2 mgd Flow Scenario)

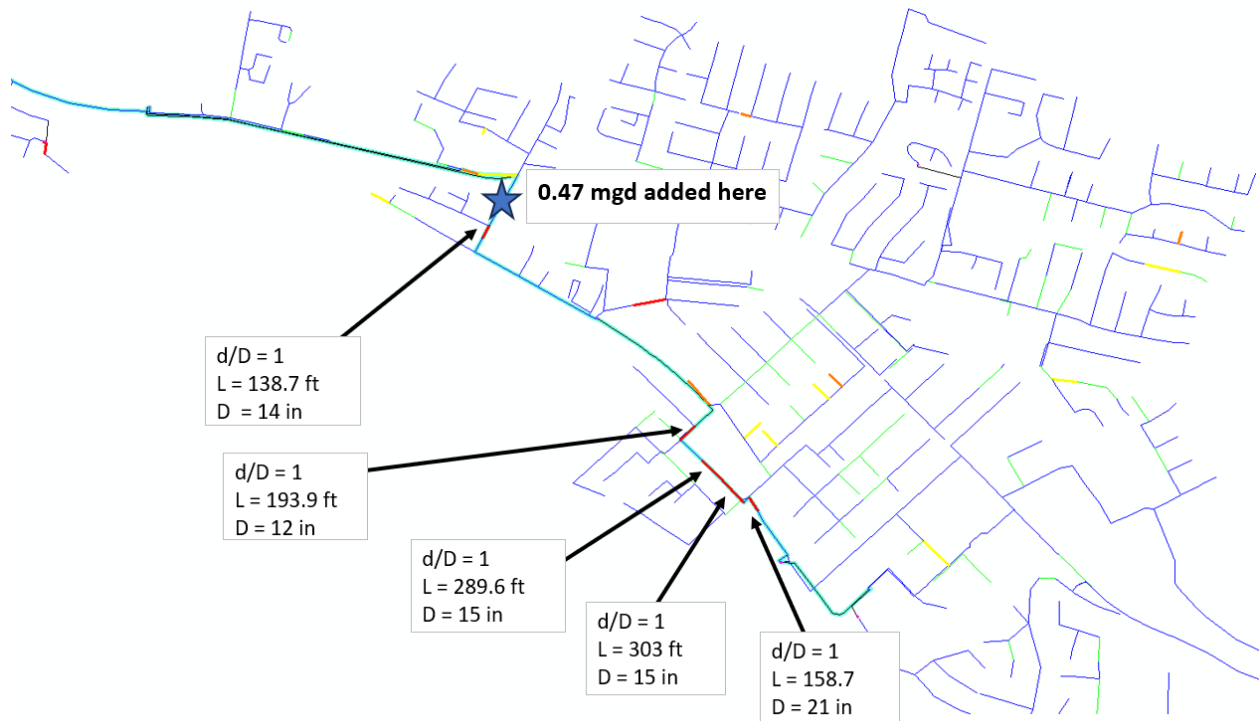

Figure 5.17 Modeled Gravity Mains Exceeding $d/D = 0.92$ (0.47 mgd Flow Scenario)

Table 5.16 0.2 mgd Flow Scenario – CSD Pipe Upsizing

Initial Pipe Diameter (inches)	Upsized Pipe Diameter (inches)	Length of Pipe Needing Upsizing (feet)
10	12	154
14	16	139

Table 5.17 0.47 mgd Flow Scenario – CSD Pipe Upsizing

Initial Pipe Diameter (inches)	Upsized Pipe Diameter (inches)	Length of Pipe Needing Upsizing (feet)
12	14	194
14	18	139
15	16	593
21	24	159

Pipe upsizing can be accomplished via several different construction methods; for the purposes of this project (and for cost assumptions) the selected method for pipe upsizing was remove and replace-in-place. A summary of this, and other common pipe replacement methods, are as follows:

- **Remove and Replace-in-Place:** Replace new pipe in the same alignment as existing. Temporary bypass piping is required during replacement to keep the system in service.
- **Replace With Parallel Pipe:** Construct the new pipe parallel to the existing. Bypass piping is not required as the existing pipe can remain in service for most of the construction time. However, the parallel alignment will require coordination with existing utilities.
- **Pipe Bursting:** Breaking and expanding the existing buried pipeline while simultaneously replacing it with a new high-density polyethylene or fusible polyvinyl chloride (PVC) pipe. The pipe size can typically be increased by up to two nominal pipe diameters using this method.

5.4.3 Summerland Sanitary District Flow Equalization

Two different flow EQ sizes were evaluated at the SSD WWTP site. The first utilizes the existing 70,000-gallon EQ basin, the other larger size utilizes the empty space on the western side of the WWTP property. Future analysis could include constructing an EQ basin at a new property, but no property was able to be identified for the purposes of this high-level study. The new EQ basin assumes a 6-foot clearance from the property fence line and from existing treatment processes. Table 5.18 shows the dimensions of the new EQ tank and Figure 5.18 and Figure 5.19 show the layout of both EQ tank options, including required supporting facilities that will be discussed in the following subsection.

Table 5.18 Flow EQ Basin Design Criteria

EQ Basin Type	Dimensions (feet)	Depth (feet)	Total Volume (gallons)
Covered Rectangular Basin	Length = 64 Width = 33	30 (plus 2 feet of freeboard)	470,000



Figure 5.18 Existing (70,000 Gallon) SSD EQ Basin and Supporting Facilities Layout



Figure 5.19 New (470,000 Gallon) SSD EQ Basin and Supporting Facilities Layout

Construction of the new, larger EQ tank will present a lot of constructability challenges. The following considerations should be kept in mind should this be pursued:

- The anticipated depth of the EQ basin is approximately 30 feet to achieve the 470,000-gallon volume. This will likely require extensive dewatering efforts throughout construction.
- Excavation will require sheet piles, it is recommended these be vibrated in to reduce noise that may disturb the adjacent residential property.
- A large staging area may be required for a clamshell excavator and crane for sheet pile installation.
- Noise restrictions and proximity to the railroad right-of-way may present challenges.

5.4.3.1 Process Mechanical Considerations

In addition to the EQ basin the following treatment processes should be added or maintained at the SSD WWTP site.

- **Grinder and bar screen:** It is recommended that the existing grinder and bar screen facilities be maintained for raw wastewater screening.
- **Screenings and screenings dewatering facility:** It is recommended a new screenings and screenings dewatering facility be constructed to remove additional particles from the raw wastewater and reduce the frequency of EQ basin cleanout. Because the EQ basin is primarily used for PWWF events, grit removal was deemed not necessary. In addition, per plant staff input, the WWTP currently gets very low volumes of grit and debris in their influent wastewater:
 - » **EQ basin cleaning:** *The EQ basin may need periodic cleaning after use. The simplest approach to accommodate this is to design the EQ basin cover with access to spray down from the top using water cannons. In addition, the cover should allow plant operators to make a confined space entry to hose down the basin from inside if needed. EQ basin floors should be sloped towards the EQ pump station wet well to allow the grit to flow towards the pumps and be pumped out of the basin.*
- **EQ pump station:** As noted above, a new pump station is required to transfer equalized flow to the CSD connection. In the case of the new, larger EQ basin, this pump station could be constructed as a wet well within the basin to save space.
- **Odor control:** It is recommended to install a new odor control facility, particularly to mitigate odors from the larger EQ basin option. To save space, this odor control could be installed over the wet well of the EQ pump station. In general, the odor control system should be installed in a space that allows for truck access for media change-out activities to occur.

Figure 5.20 shows an example of a 1.6 mgd screenings, dewatering, and odor control system recently installed at the City of Morro Bay's WWTP. This is a similar process to what would be required at the SSD WWTP for pretreatment ahead of EQ.



Figure 5.20 City of Morro Bay Screenings, Dewatering, and Odor Control System

Odor Control System Sizing and Recommendations

While there are numerous odor control technology options available, for the purposes of this evaluation a simple technology using a GAC tower with a high-capacity media is assumed. Equipment assumed for sizing and evaluation purposes is round single bed carbon adsorber (at 3 to 4 second empty bed residence time [EBRT]) as this system is a highly operator-friendly, hands-off approach and, depending on actual hydrogen sulfide (H_2S) values anticipated it may also be the most economical option available. Figure 5.21 shows a photo of a carbon adsorber system, installed at DCWater in Washington D.C.



Figure 5.21 DCWater Carbon Adsorber Odor Control System

Odor control system sizing for each alternative was based on air space for the total volume of each EQ basin. Since these basins will be used cyclically during wet weather events, sizing for the largest possible air space provides for a comfortable level of conservation at this level of study. Ventilation calculations assume a rate of two air changes (ACs) per hour for the empty volume, as the level of wastewater within the EQ basin rises so too will the ACs. Table 5.19 shows the design criteria for the carbon adsorbers for both sizes of EQ basins.

Table 5.19 EQ Basin Odor Control Sizing

Flow Scenario (mgd)	Approximate EQ Volume (cf)	Required Ventilation Rate (cfm)	No. of Carbon Adsorber Vessels	Adsorber Diameter (feet)	Adsorber Height (feet)	EBRT (seconds)
0.2	67,600	2,300	1	8	9	3.93
0.47	9,700	350	1	3	8	3.64

Notes:
 cf - cubic feet; cfm - cubic feet per minute

Should this project proceed into design, other odor control options could be considered. Common technologies include:

- **Biotrickling filter towers (BFTs):** At 12- to 15-second EBRT, BFTs are excellent for moderate and high H₂S levels. They can make for a cost-effective solution but usually this technology requires approximately two weeks to acclimate and can be prone to upset conditions if H₂S levels drop or are not maintained above 1 part per million. In addition, the BFT is large, at 8-foot diameter and 20-feet tall, which would be harder to hide behind a fence, a likely concern for the adjacent residential neighbors, and requires more frequent maintenance than carbon adsorbers.
- **In-ground biofilters:** Require a 30- to 45-second EBRT. Unfortunately, these take up a sizable footprint; an in-ground biofilter that is nearly 20-feet by 20-feet with an approximately 4-foot-deep bed gives a 42 second EBRT at 2,300 cfm. A deeper bed may be an option to reduce the footprint. Synthetic media with a thermally applied nutrient coating is suggested, but a more cost-efficient option with woodchip or bark media can be purchased. Organic media has a more frequent change-out (approximately every four to five years), creating some maintenance for the operator.
- **Chemical scrubber:** This option requires the most maintenance and presents safety concerns for chemical deliveries. This option is not recommended in remote areas or in neighborhoods.

CHAPTER 6 REVERSE OSMOSIS CONCENTRATE DISPOSAL

6.1 Introduction

This chapter provides an overview of the options available for ROC disposal for the potential projects evaluated as a part of this study. The two mechanisms of ROC disposal discussed in this chapter are ocean outfall disposal and deep well injection.

6.2 Reverse Osmosis Concentrate Background and Context

The use of RO results in the generation of ROC. The amount of ROC depends upon the recovery of the RO system, which is typically 80 percent to 85 percent. Lower recoveries (75 percent) can occur due to challenging feedwater quality and higher recoveries can be obtained through more complex RO treatment engineering (greater than 95 percent).

This project evaluates how to provide disposal of ROC for the following projects summarized in Table 6.1.

Table 6.1 Summary of RO and ROC

Project	RO Feed Flow, (gpm)	RO Recovery (Percent)	Quantity of ROC, (gpm)	ROC Discharge Location
City of Solvang Project	694	80	139	Deep Well Injection
City of Buellton Project	299	80	60	Deep Well Injection
Combined Solvang/Buellton Project	708	80	141	Deep Well Injection
SSD Project	56 ⁽¹⁾ 694 ⁽²⁾ 750 ⁽³⁾	80	150 ⁽³⁾	CSD Ocean Outfall

Notes:

- (1) This RO feed flow is based on SSD ADWF (0.08 mgd).
- (2) This RO feed flow is based on CSD ADWF (1.0 mgd).
- (3) The total RO feed flow is the combination of SSD and CSD ADWF.

The SSD component of the project is readily addressed through discharge of ROC into the existing CSD outfall and requires no further study. This ROC disposal analysis for this project focuses entirely upon the Solvang and Buellton projects, injecting the ROC deep underground. The long running LCSD WRP (since around 2000) discharges ROC in a similar manner.

6.3 Reverse Osmosis Concentrate Disposal Options

6.3.1 Ocean Outfalls

The proposed SSD project involves the discharge of raw wastewater into the CSD for the purpose of AWT. In accordance with the planned CAPP project, the ROC generated from advanced treatment of the SSD and CSD wastewater will be disposed of through the existing CSD ocean outfall for discharge. Sampling and analysis of water quality is ongoing in support of NPDES compliance for CAPP.

6.3.2 Deep Well Injection

Deep well injection has been used for many years in the oil and gas industry to dispose of liquid waste into geological formations with no potential to allow for migration into shallower, potable water aquifers.

Due to the inland location of Solvang and Buellton, deep well injection was the only ROC disposal mechanism considered for these potable reuse projects as pursuing an ocean outfall would require a lengthy, expensive pipeline and extensive permitting process.

For the purposes of evaluating deep well injection sites, abandoned oil and gas wells drilled in the proximity of the two cities were evaluated. Figure 6.1 provides an area map showing the location of the two WWTPs (Solvang and Buellton) along with the location of abandoned oil and gas wells drilled in the area. The oil and gas wells indicate that there are ample locations for ROC discharge that can be permitted.

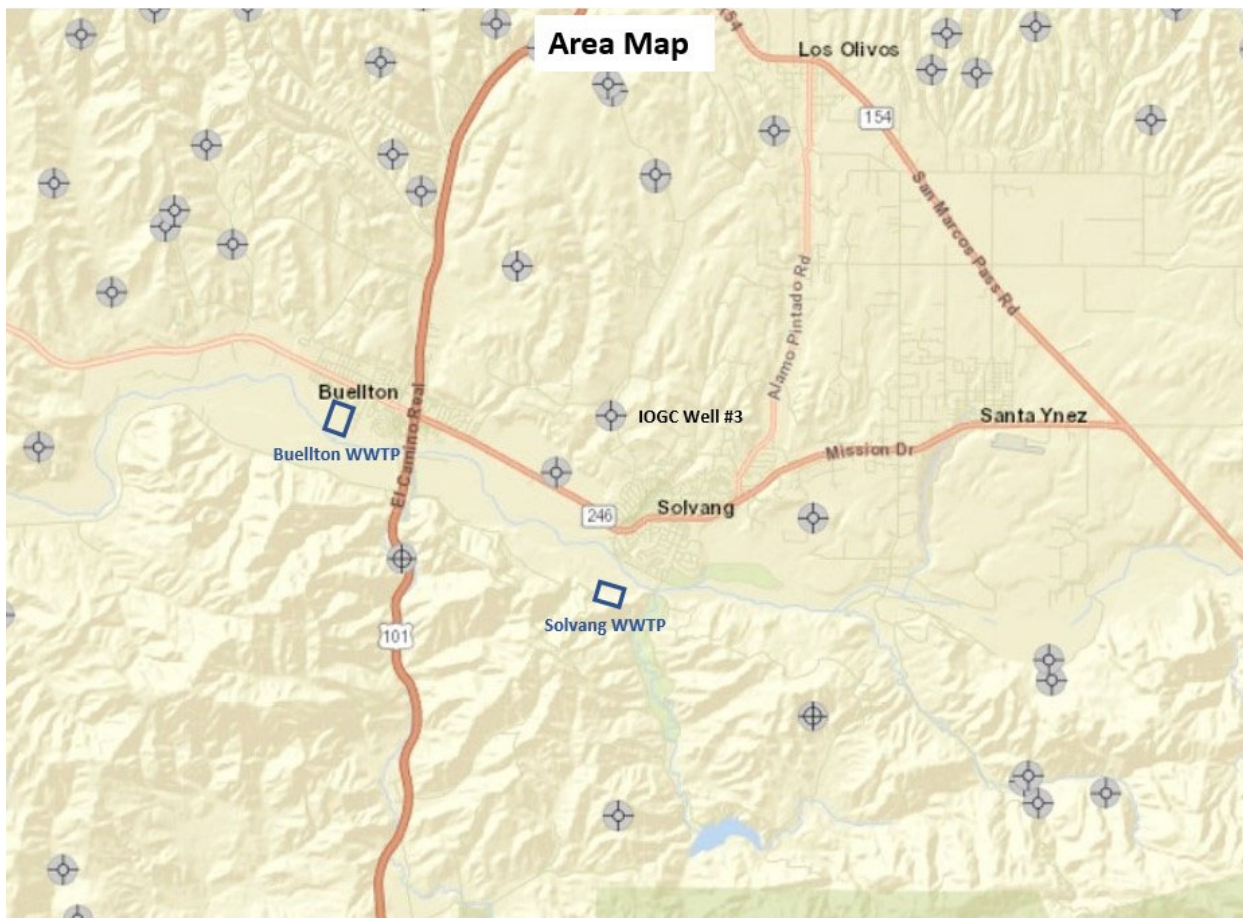

Figure 6.1 Abandoned Oil and Gas Wells Near Solvang and Buellton

6.3.2.1 Santa Ynez Valley Geology

The Solvang and Buellton WWTPs are located within the Santa Ynez Valley in the County. Both plants are adjacent to the Santa Ynez River that flows westward from Lake Cachuma to the Pacific Ocean near Lompoc, California. The Santa Ynez Valley is located between two folded and upthrust areas created

during land movement during the Pliocene epoch. Prior to that during the Eocene through Miocene epochs, the deposits of mud, sand, and gravel created the Sespe, Vaqueros, Rincon, and Monterey formations which were later covered by younger formations and subjected to land movement. The uplift and folding along the Santa Ynez fault caused the rise of the land to the north of the valley and the uplift of the San Gabriel Mountains along the fault to the south contributed to deposition of materials within the valley. The water within the valley created the Santa Ynez River which flows out the western end of the valley and onto the Lompoc Plain.

The deeper formations which were deposited prior to the folding and uplift of the mountains were deformed by the mountain building and were uplifted on both sides of the valley creating a syncline structure within the valley. A review of geologic cross sections indicates that the valley gets narrower as you move from the Lompoc area eastward toward Solvang and Lake Cachuma. The valley ends at the eastern end of Lake Cachuma due to faulting and uplifted formation near Santa Barbara.

6.3.2.2 Potential Injection Formations

There has been historical drilling activity within the Santa Ynez Valley in the areas near Solvang and Buellton. Many of these wells were drilled back in the 1930s and 1940s and were abandoned after drilling due to not finding producible quantities of oil. With geology very similar to the Lompoc area within the valley, the oil drillers were hoping to find oil within the Monterey Formation similar to the oil found in the Lompoc Field.

To better delineate the subsurface formations in the Solvang and Buellton area, historical reports and well drilling information were reviewed to collect depth information, formation properties information, and if available, oil/water production information. This information was evaluated to look at potential injection into the Monterey Formation in the area. Two structural cross sections were in a report prepared by Geosyntec in 2020 as they studied the groundwater basin. The cross sections provide a visual depiction of the uplifted sides of the valley. Figure 6.2 is a map showing the approximate locations of the two cross sections. Figure 6.3 is a cross section of the valley west of the Buellton area and Figure 6.4 is a cross section which is directly across the Buellton area (approximately parallel to Highway 101).

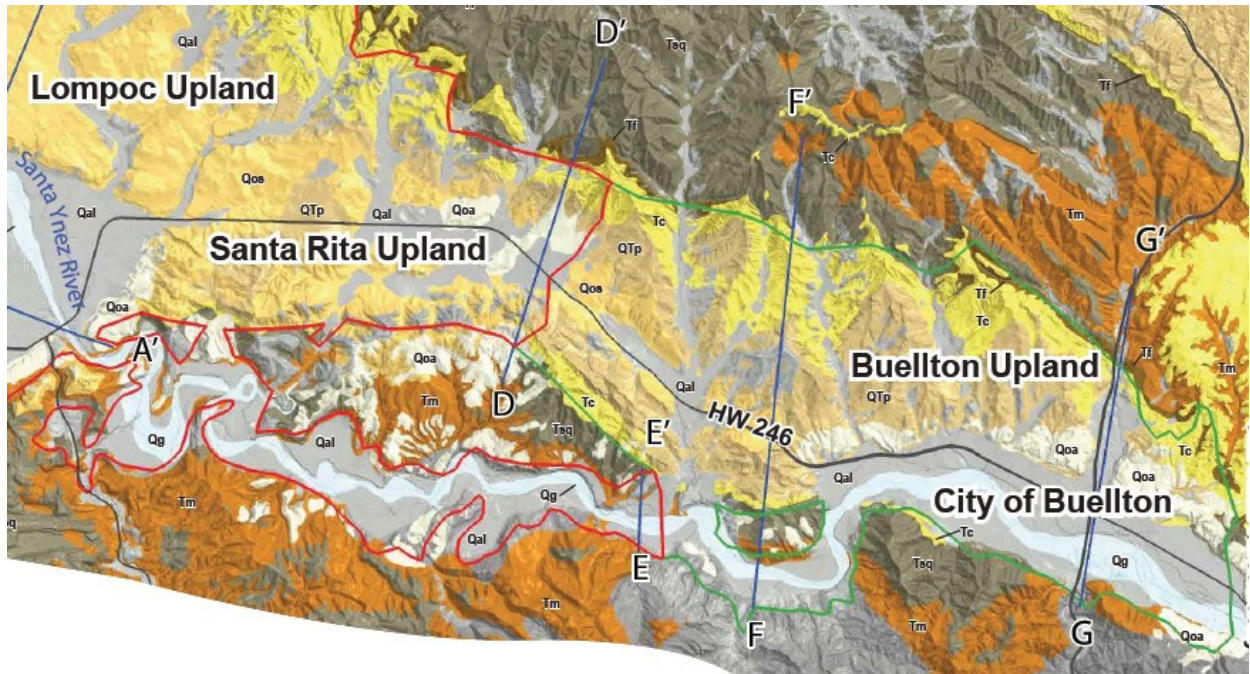

Figure 6.2 Cross Section Map

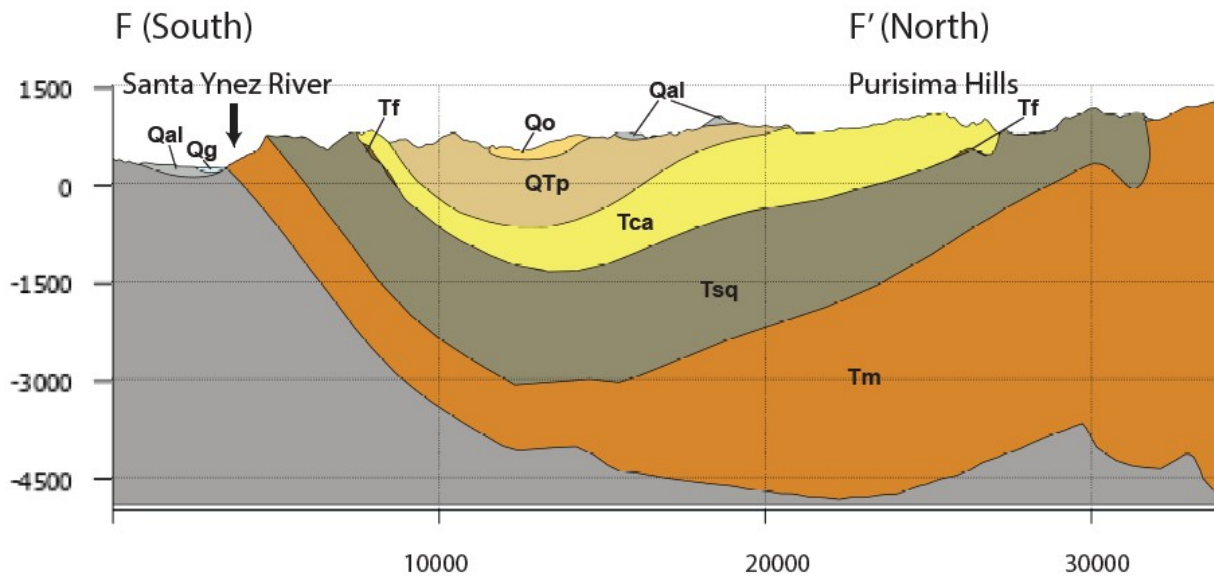

Figure 6.3 Cross Section F - F'

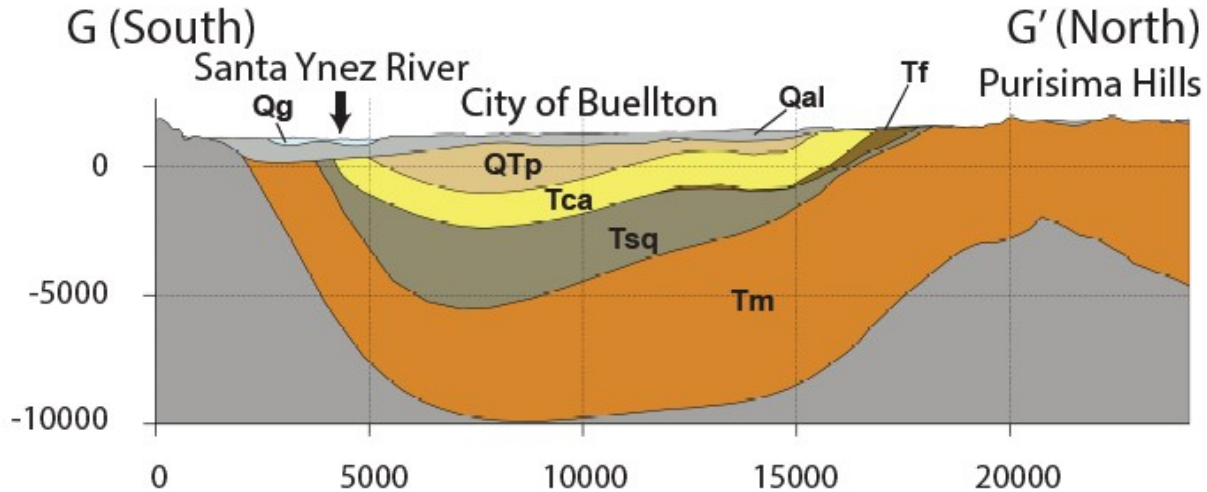

Figure 6.4 Cross Section G - G'



Figure 6.5 Formation Legend for Cross Sections

These cross sections show the narrowing of the valley as one moves east from Figure 6.3 to Figure 6.4. The southern edge of the valley has a more pronounced upward thrust that result in the formations becoming steeper dip while to the north the uplift is more gradual. Within these cross sections can be seen the typical formations for this area with the Monterey Formation being the primary formation of interest for injection.

The Monterey Formation is the principal oil producing zone in the area with production in the oil fields to the west (Lompoc, Orcutt, and Santa Maria Valley) and to the north (Zaca and Barnum Ranch). It consists of tightly carved, dark brown, hard, siliceous, fractured shale. Fracturing is variable depending upon proximity to faults and flexures. The shale typically has low matrix permeability but significantly higher fracture permeability. In the various oil producing areas, the fracture porosity ranges from 0 to over 30 percent with the permeability being anywhere from 150 millidarcy to over 1.0 darcy. Within the area near Solvang and Buellton, there were only a couple of wells drilled deep enough to reach the Monterey Formation.

In the Solvang area, a well drilled approximately 1.5 miles north of the WWTP showed the top of the Monterey Formation at 3,500 feet with water and oil present. This indicates that the formation is fractured but unproductive of oil in the area. In a well drilled approximately 2 miles west of Buellton, the Monterey Formation was found at 5,370 feet and was noted as being highly fractured shale with heavy oil. Wells drilled to the north and south of the center part of the valley also noted that the Monterey Formation was

present but at either the surface (well south of the valley) or at shallow depths due to the well being near the northern side of the valley.

As shown in the cross sections and in the few wells drilled within the valley that are deep enough to reach the Monterey, the formation is deep enough to be considered for injection purposes in the central part of the valley. The Sisquoc Formation is located above the Monterey and it is a good confining layer for injection purposes.

After reviewing the geology and potential injection formations in comparison to the location of the Solvang and Buellton WWTPs, there is good potential for injection of ROC in the area.

6.3.2.3 Feasible Injection Sites

Solvang Wastewater Treatment Plant

The Solvang WWTP location is not a viable location for injecting water. The WWTP is located on the far south side of the valley and is too far south to have viable formation for injection. The subsurface formations are likely to be steeply dipping due to the uplift on the south side of the valley. A review of the cross sections and surface geology maps indicate that the Monterey Formation is likely present at the surface in the area of the WWTP and vertically oriented making it unusable for injection.

Injection wells for the Solvang ROC would need to be located at least 1.5 miles north of the WWTP to have the Monterey Formation deep enough and oriented horizontally for injection purposes. Based on the well data for the Interstate Oil and Gas Company (IOGC) Well No. 3 well drilled in 1908 (abandoned well located 1.5 miles north of Solvang WWTP), the Monterey Formation is present at approximately 3,500 feet and is a good potential injection zone based on the data from the drilling of the IOGC Well No. 3. Additional information available about IOGC Well No. 3 is as follows:

- Drilled by the Santa Barbara Oil Company, Ltd. in 1908.
- Drilled to a depth of 3,613 feet.
- Cased with 12-1/2-inch, 10-inch, 8-1/4-inch, 6-5/8-inch, and 4-1/2-inch casing.
- The IOGC took over the well in 1917.
- The well was abandoned in April 2018.
- Cement plugs at around 1,232 feet.

If Solvang has land available near the abandoned IOGC Well No. 3, an ROC injection well could be located there and piped to the WWTP.

Another option for the Solvang ROC disposal is to send the water north to the Zaca Oilfield. While some areas of the field are still producing, the formation in the area would make a good injection formation. One hurdle to using that area for injection is the fact that the field is still being produced and an agreement would be needed with the current operator and with the California Geologic Energy Management Division (CALGEM), who manages the oil and gas operations for the State of California. Due to the age of the field, the operator may welcome the addition of wastewater to enhance their waterflood operations, but the potential for the wastewater to be produced by the well operator might be an issue with the EPA who manages the Class I injection program in California. Figure 6.6 provides a map of the areas discussed.

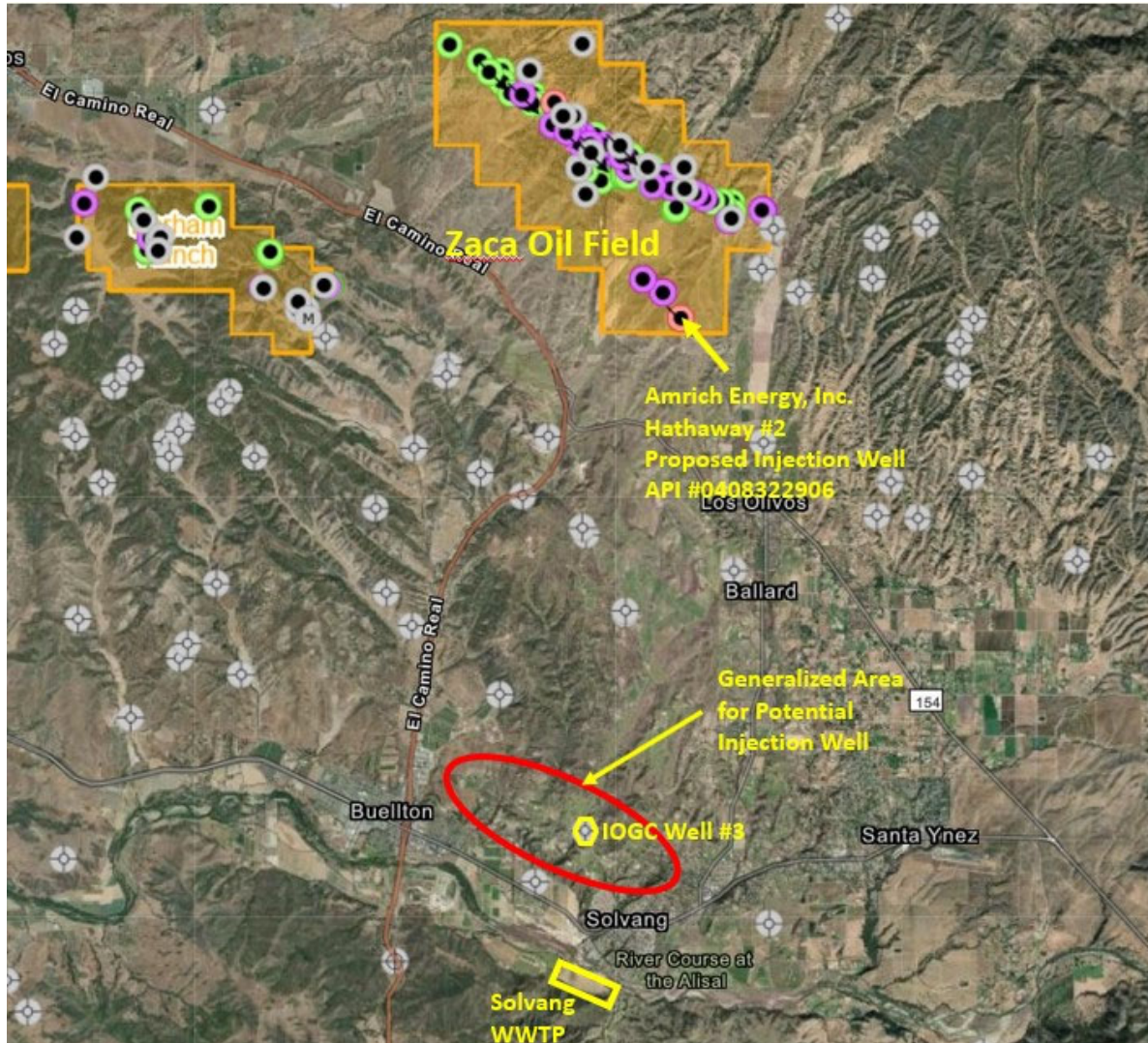

Figure 6.6 Solvang Potential Injection Areas

There is an area on the very south end of the Zaca Oilfield where Amrich Energy proposed drilling a disposal well into the Monterey but never drilled the well. There may be an opportunity to purchase the lease/land, depending on the lease status, and drill a disposal well in that location. That location is more than 1/2 mile from any other well which can make permitting easier. While Amrich Energy did propose to drill a disposal well at that location, there is no conclusive data that indicates that the Monterey Formation can accept water at that location. Testing of the formation would need to be conducted. Further information about the proposed well (known as Hathaway Well No. 2D) is as follows:

- The well was proposed to be drilled in November 2014 to a total depth of 5,976 feet into the Monterey Formation.
- The surface location of the proposed well is Sec 10, T7N, R31W, 2,083,906N and 5,920,710 E NAD 83 California State Plane.
- Two additional existing wells are located west of the proposed well site (Hathaway No. 1 and No. 2).

Both potential disposal areas would require the drilling of a new disposal well for injection purposes. The option of using an existing idle oil and gas well is not allowed by CALGEM. In previous discussions with CALGEM and the district deputy (Miguel Cabrera), he indicated that they would not allow unplugged, idle production wells to be purchased by anyone for use as a Class I well. He indicated that their history has shown that multiple operators have sold/transferred their wells to farmers and other groups to shed their responsibility for the well and to take the wells out of the CALGEM oversight. These wells were then not monitored to ensure the planned use of the well took place and later these wells became a source of contamination. Therefore, they have taken a hard line that these idle wells cannot be repurposed.

Buellton Wastewater Treatment Plant

The Buellton WWTP location is potentially a much better location for an injection well. With the Buellton WWTP property being located to the north of the river, the Monterey Formation should be between 4,000 and 5,000 feet deep and have good fracture permeability. In addition, a well log located in the area near Buellton also shows the presence of the Point Sal Formation directly below the Monterey Formation. The Point Sal is a sandstone formation that is typically high in porosity and permeability. These characteristics, if available, add to the injectivity in the area and enhance the chances for siting an injection well in the area.

There is a chance that the area directly under the WWTP may be more on the uplift side of the valley cross section, which will find the Monterey Formation at a shallower depth and with a less than horizontal dip. In this case, the potential well may need to be located further north to penetrate the formation at a deeper, more horizontal dip location. In that case, the injection well could be drilled on land acquired west and north of Buellton or the well could be directionally drilled northward from the WWTP property to intersect the formation at a deeper depth. Figure 6.7 provides a map of the potential injection area.

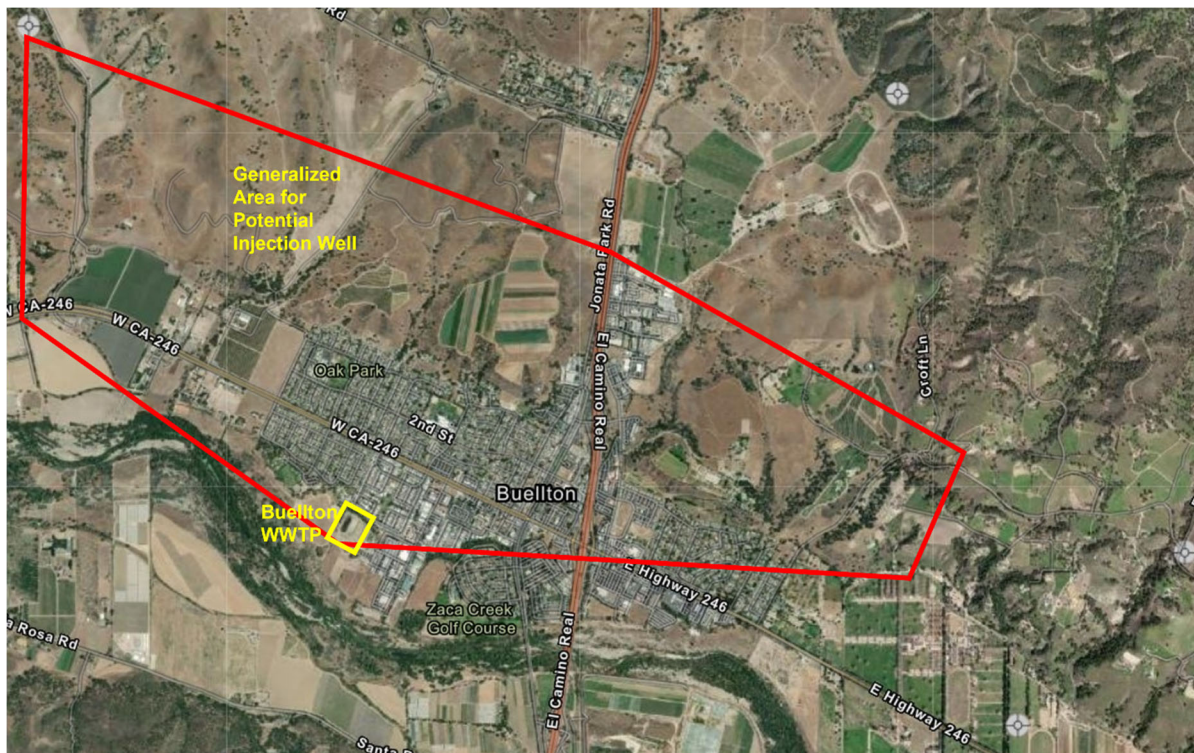

Figure 6.7 Buellton Potential Injection Area

6.3.2.4 Recommendations

The biggest unknown is the actual depth and condition of the formation at the location of the WWTP or other potential drilling sites. A recommended path forward for each WWTP is shown below:

- **Solvang:** With the Solvang WWTP location not being a viable site to drill a disposal well, a “Solvang Only” project needs to decide on how to handle the ROC. The best option is to locate property near the abandoned IOGC Well No. 3 location and drill a test well. Since the depth and injectivity of the formation is unknown, drilling a test well could provide the data needed to verify the well as a site for injection of ROC along with the data needed for permitting the site with the EPA. If Solvang decides to look at sending the water to the Zaca Oilfield area, negotiations would be needed with both CALGEM and the operating oil company. These negotiations can be avoided if the proposed location is more than 1/2 mile from an operating well.
- **Buellton:** The Buellton WWTP site is a possible site for installation of the ROC injection well. This site could be used for a “Buellton Only” project or a combined project with Solvang. The WWTP site is located near the south side of the valley where the subsurface formations may start being uplifted but is believed to be far enough north that the Monterey Formation will be near horizontal. As such, the well could be potentially drilled on that site. If the formation is found at a shallower depth or steeply dipping, a new well could be sited to the northwest of the plant site where all indications point to the formation being around 5,000 feet deep. The well could also be directionally drilled northwest from the WWTP site. The only way to assess the formation is to drill a test well and gather data from logs and cores.

It is recommended that a test well be drilled at the proposed locations to determine the depth, quality, and injectivity of the Monterey Formation at each proposed injection well site. With the lack of good geological data in the areas where injection wells are needed, a test well can provide all the necessary data to verify that injection is possible at the rates required. These test wells would need to be permitted through CALGEM as geologic test wells. Negotiations with the state would be needed to obtain approval for short term injection tests to gather injectivity data and to conduct a bottom hole pressure survey and fall off test to gather permeability data.

Depending on the approvals from CALGEM, these test wells may be able to be configured for conversion to Class I injection wells. While CALGEM has taken a stand to not allow abandoned, idle wells to be bought and converted to Class I injection wells, they may be agreeable to a planned conversion of a test well if the correct agreements are in place prior to drilling.

It is recommended that each of the two sites have two injection wells to provide a backup in case of well failure or injectivity problems. For constructability and ease of operations, it is recommended to have the wells located relatively close to each other.

6.4 Reverse Osmosis Concentrate Regulatory Compliance Challenges

The following subsections detail the anticipated permitting process for incorporating ROC discharge into an existing ocean outfall as well as permitting a new ROC deep well injection site.

6.4.1 Ocean Outfalls

The SWRCB develops water quality control planning documents that designate beneficial uses and water quality objectives for groundwater, surface water, and marine waters within the state. The relevant plan governing permitting considerations for the existing CSD outfall is the *California Ocean Plan*.¹ Under the SWRCB, nine RWQCBs issue permits to dischargers that enforce the requirements set forth by the relevant water quality control planning document. The permits are in the form of NPDES permits for surface water discharges. The Central Coast RWQCB has jurisdiction over and issues NPDES permits for the CSD WWTP.

Water quality based effluent limitations in the NPDES permit are based on the amount (mass, concentration, or both) of a specific pollutant that can be discharged into the receiving water body while still meeting the water quality objectives. Water quality based effluent limitations are calculated for any given facility using the water quality objectives and applying a dilution ratio that accounts for the rapid mixing that occurs in the receiving water body as the treated effluent exits the outfall diffuser.

The RWQCB has shown flexibility to meet water quality based effluent limitations for potable reuse projects, while remaining protective of the environment. Other purified water projects in the state, such as in Monterey and Morro Bay, have successfully negotiated multiple dilution factors to maintain concentration-based limits and are also subject to the governance of the *California Ocean Plan*.

In general, the following steps could be taken to negotiate alternative limits in an NPDES permit, such as a mass-based limit, to incorporate ROC into an existing outfall:

1. Perform a preliminary Reasonable Potential Analysis to determine the concentrations of the resulting stream of ROC and wastewater effluent. Compare the resulting waste stream against relevant NPDES limitations. This effort is well underway for the CAPP project.
2. Perform outfall plume modeling for a range of ROC and wastewater effluent flow combinations to determine if there are anticipated NPDES permit violations and how much dilution would be needed to mitigate these exceedances. This effort is well underway for the CAPP project (done by others) and is anticipated to be successful.
3. If the efforts above are not successful, develop different dilution factors for identified constituents. Different outfall diffuser configurations can also be considered in this exercise.
4. If the efforts above are not successful, perform a more detailed Reasonable Potential Analysis after the dilution factors have been developed. Such an analysis was not done for this project.
5. If needed, conduct discussions with the RWQCB to negotiate and request permit changes including mass-based limits and updated dilution factors.

6.4.2 Deep Well Injection

The Class I injection wells required for ROC disposal will be permitted by the US EPA Region 9 office in San Francisco. The permit process requires the preparation of a detailed permit application that provides the EPA with all the information on the injection operation along with geological information that shows

¹ SWRCB (2019). California Ocean Plan, February 2019.
https://www.waterboards.ca.gov/water_issues/programs/ocean/docs/oceanplan2019.pdf.

that the proposed injection will not contaminate any underground sources of drinking water. The application will include the following information:

- Area of review information (wells in the area near the proposed well).
- Summary of the geological information around the proposed injection site(s) both shallow and deep geology.
- Preparation of a detailed drilling procedure.
- Injection process details including details on storage, pumps, filtration, and monitoring system.

Preparation of this information is time consuming and requires the oversight and signatures of a professional engineer and geologist. The gathering of all this information and preparation of drilling and operational plans, along with making multiple copies of all the information generated for the application can take approximately three months to prepare, have reviewed internally, and submit to the EPA. Considerable information related to facility operations, fluid composition, and surface facility initial designs will be needed for the application.

As noted, the application for both deep well injection sites will be for two injection wells to provide a backup in case of well failure or injectivity problems. As a part of the permitting process, the total injection into both wells cannot exceed the permitted maximum injection rate. To prepare the application for both wells for submittal to EPA will take approximately three months including responding to one round of EPA comments on the content of the application.

The EPA can take 12 to 18 months in total to complete the permitting process. This schedule estimation includes two rounds of comments from the EPA prior to issuing a draft permit. Once the draft permit is issued, public comment can take up to 60 days to complete. Based on previous work with the EPA, the permitting process is expected to take 1.5 to 2 years to complete.

CHAPTER 7 PLANNING LEVEL COSTS

7.1 Introduction

This chapter provides an overview of cost assumptions and cost estimates for each project evaluated as a part of this study. Detailed cost estimates are available in Appendix E. In addition, implementation plans for each project are discussed at a high level.

7.2 Planning Level Cost Basis

The AACE International has suggested levels of accuracy for five estimate classes. These five estimate classes are presented in the AACE International Recommended Practice No. 18R-97 (Cost Estimate Classification System - As Applied in Engineering, Procurement, and Construction for the Process Industries). Table 7.1 presents a summary of these five estimate classes and their characteristics, including expected accuracy ranges.

Table 7.1 Classes of Cost Estimates

Estimate Class	Maturity Level of Project Definition Deliverables ⁽¹⁾	End Usage ⁽²⁾	Methodology ⁽³⁾	Expected Accuracy Range ⁽⁴⁾
Class 5	0 to 2 Percent	Concept Screening	Capacity Factored, Parametric Models, Judgement, or Analogy	L: -20 to -50 Percent H: +30 to +100 Percent
Class 4	1 to 15 Percent	Study or Feasibility	Equipment Factored or Parametric Models	L: -15 to -30 Percent H: +20 to +50 Percent
Class 3	10 to 40 Percent	Budget, Authorization, or Control	Semi-Detailed Unit Costs With Assembly Level Line Items	L: -10 to -20 Percent H: +10 to +30 Percent
Class 2	30 to 75 Percent	Control or Bid/Tender	Detailed Unit Cost With Forced Detailed Take-Off	L: -5 to -15 Percent H: +5 to +20 Percent
Class 1	65 to 100 Percent	Check Estimate or Bid/Tender	Detailed Unit Cost With Detailed Take-Off	L: -3 to -10 Percent H: +3 to +15 Percent

Notes:

- (1) Expressed as percent of complete definition.
- (2) Typical purpose of estimate.
- (3) Typical estimating method.
- (4) Typical variation in low and high ranges at an 80 percent confidence interval.

The costs presented in this section are preliminary and therefore considered an estimate. As such, costs should be refined and updated as the project progresses. The costs detailed herein are Class 5 level estimates. Class 5 estimates are considered to be 0 to 2 percent of the total project maturity level and should be considered only for concept screening as expected accuracy has potential to have great variance.

The quantity and quality of the information required to prepare an estimate depends on the end use for that estimate. Typically, as a project progresses from the conceptual phase to the study phase, preliminary design, and final design, the quantity and quality of information increases, thereby providing data for

development of a progressively more accurate cost estimate. A contingency is often used to compensate for lack of detailed engineering data, oversights, anticipated changes, and imperfection in the estimating methods used. As the quantity and quality of data becomes better, smaller contingency allowances are typically utilized.

7.2.1 Cost Estimating Methodology

The costs presented in this section are preliminary and therefore considered an estimate. As such, costs should be refined and updated as the project progresses. The costs detailed herein are Class 5 level estimates. Class 5 estimates are considered to be 0 to 2 percent of the total project maturity level and should be considered only for concept screening as expected accuracy has potential to have great variance. The expected range of accuracy for a Class 5 cost estimate is -30 percent to +50 percent; this means that for a \$100 estimated project cost, future bids would be expected to fall into a range of \$67 to \$130.

The project's cost estimates are comprised of both direct costs and indirect or "soft" costs. Direct costs are those directly attributed to the physical make-up of the work (e.g., site development, treatment equipment, pumps, piping, etc.). The sum of all direct costs is the "Total Direct Cost."

Indirect costs consist of contingency factors, including estimating contingency, general conditions, contractor overhead and profit, sales tax, and engineering/legal/administration. In the summary table below, markups are included below the "Total Direct Cost" row. A summary of the markups that were included here is provided in Table 7.2. The assumed percentage for each markup, and the order in which they were applied, is shown in Table 7.3.

Table 7.2 Indirect Cost Factors Included in Cost Estimates

Factor	Description
Estimating Contingency	Captures miscellaneous direct costs that would not otherwise be itemized within a direct cost category.
Sales Tax	State and local sales taxes on material goods, applied to 50 percent of total direct costs.
General Conditions	Accounts for items such as mobilization, demobilization, the contractor's temporary facilities, major construction equipment that cannot be distributed to a specific item of work, testing, start-up, commissioning, and project site supervision.
Contractor Overhead and Profit	This value includes general contractor home office overheads, sales tax, and profit.
Engineering, Legal, and Administrative	Engineering design and services during construction, construction management, legal, and administrative costs.
Owner's Reserve for Change Orders	Unforeseen site conditions and contractor change orders or claims that increase the final as-built price above the anticipated bid value for the project.

Table 7.3 Summary of Project Cost Estimating Methodology

No.	Description	Percentage	Example
01	Treatment Equipment	-	\$100
02	Site Work	-	\$100
03	Pump Station	-	\$100

No.	Description	Percentage	Example
04	Other	-	\$100
05	Other 2	-	\$100
	Total Direct Cost	-	\$500 (A)
	Estimating Contingency	30 Percent of (A)	\$150 (B)
	Sales Tax (On Materials and Construction Equipment) ⁽¹⁾	7.75 Percent of 0.5*(A)	\$19 (C)
	General Conditions	20 Percent of (A+B)	\$130 (D)
	Contractor Overhead and Profit	15 Percent of (A+B)	\$98 (E)
	Total Construction Cost	A+B+C+D+E	\$897 (F)
	Engineering, Legal, and Administration Fees	12 Percent of (F)	\$108 (G)
	Owner's Reserve for Change Orders	5 Percent of (F)	\$45 (H)
	Total Estimated Project Cost	F+G+H	\$1,050

Notes:

(1) The tax rate for each evaluated project will differ based on each city's sales tax rate. As of 2023, the Solvang sales tax is 8.75 percent and Buellton and Summerland sales tax are both 7.75 percent.

It is important to note that the project cost estimates provided are in today's dollars at the time of writing. If a project is implemented in the future, the cost estimate would need to be escalated to account for cost increases over time. Escalation can significantly impact project costs, especially given recent economic trends where annual escalation rates of 5 to 10 percent have been observed. For example, if the project were to be implemented in 5 years, with an assumed escalation rate of 5 percent, the total project cost would increase by 28 percent. An annual escalation rate of 10 percent would result in a project cost increase of 60 percent over 5 years.

7.2.1.1 Treatment Cost Methodology

Unlike cost estimating of infrastructure (see section below), cost estimating for PRW treatment systems cannot draw upon a large installation base. There are only a handful of operating projects in California for IPR and no operating systems in California for DPR. Further, the operating systems are, to a great extent, of very different capacities than the systems evaluated for this project. Accordingly, the approach to treatment system cost analysis is more time intensive and relies upon detailed sizing of treatment components and gathering of supplier specific cost information (price quotes for skid mounted equipment).

7.2.1.2 Infrastructure Cost Methodology

The following subsections detail the assumptions used for the infrastructure requirements for each project.

Advanced Water Purification Facility Feed and Finished Water Piping Costs

Feed and finished water piping for the Solvang, Buellton, and Solvang/Buellton Combined AWP is assumed to be cement mortar lined and coated ductile iron pipe. The direct cost for piping required includes the pipe material cost, developed from vendor quotes, and includes an installation cost based on the type of area where the pipeline will be placed. For example, the installation cost for a pipeline through

an open field is lower than a pipeline through a developed neighborhood. Table 7.4 and Table 7.5, respectively, show the pipe material costs and installation costs assumed for these pipelines.

Table 7.4 AWPF Feed and Finished Water Pipe Material Costs

Pipe Diameter (inches)	Pipe Material Cost (\$/linear foot)
4	\$31.90
6	\$38.50
8	\$45.10
10	\$51.70
12	\$58.30
16	\$82.50

Table 7.5 AWPF Feed and Finished Water Pipe Material Costs

Type of Area Where Pipeline Will be Placed	Installation Cost (\$/inch-diameter)
Open Field	\$10.00
Mostly Open	\$14.00
Developed	\$20.00

Using these respective unit costs, the total direct cost per linear foot of piping is calculated as follows:

$$\text{Total Direct Cost} = \text{Pipe Material Cost} \left(\frac{\$}{\text{linear foot}} \right) + \left(\text{Installation Cost} \left(\frac{\$}{\text{inch-diameter}} \right) * \text{Pipe diameter} \right)$$

Raw Wastewater Piping Costs

Raw wastewater piping for the SSD project is assumed to be C900 PVC pipe. The direct cost for piping required includes the pipe material cost, developed from vendor quotes, and includes an installation cost based on the type of area where the pipeline will be placed. The installation costs are the same as those estimated for the feed and finished water costs. In the case of the SSD raw wastewater pipeline, all piping required is located in fairly developed areas. Table 7.6 shows the pipe material costs and installation costs assumed for these pipelines.

Table 7.6 Raw Wastewater Pipe Material Costs

Pipe Diameter (inches)	Pipe Material Cost (\$/linear foot)
6	\$52.12
12	\$89.56
14	\$105.66
16	\$122.82
18	\$142.41
24	\$217.18

Costs were also developed for wastewater pipe upsizing within the existing CSD system using the remove and replace-in-place construction method noted in Chapter 5. Costs required for replacement include the following:

- New PVC pipe (based on the unit costs noted in Table 7.6).

- Pavement cutting and removal, trench excavation, and new backfill to remove and replace pipe (cost dependent on size of trench required for each pipe segment).
- Temporary bypass piping (estimated at approximately \$10/linear foot of bypass piping).

Pumping Costs

For the purposes of this feasibility study, pump station costs were estimated on a \$/hp basis. Table 7.7 shows the assumed \$/hp direct costs.

Table 7.7 Pump Station Direct Costs

Pump Station Size (hp)	Direct Cost (\$/hp)
30 hp and Smaller	\$25,000
30 to 125 hp	\$21,500
125 to 500 hp	\$13,000
600 to 1,000 hp	\$11,000
1,000 hp and Larger	\$9,000

7.2.2 Cost Basis

The project's capital and O&M costs are divided into two key categories:

- Infrastructure costs.
- Treatment costs.

For the Solvang and Buellton projects, infrastructure costs include the cost to transfer secondary wastewater effluent from the WWTP to the new AWPf facility (including flow EQ), transfer ROC to deep well injection sites, and transfer finished water to either injection well sites (for IPR) or to connect to the distribution system (for DPR). Note that IPR costs for the project options include two infrastructure cost options for piping to the identified 6-month injection site and 12-month injection site. For the SSD project, infrastructure costs include the cost to transfer raw wastewater from the existing WWTP to connect to the CSD collection system (including flow EQ at SSD).

For the Solvang and Buellton projects, treatment costs include all costs associated with constructing the treatment needed to create water fit for IPR or DPR. For the SSD project, treatment costs include the cost of screenings and odor control facilities required at the SSD WWTP associated with raw wastewater EQ.

O&M costs for each project include power consumption, chemical consumption, and maintenance. The Solvang and Buellton projects also include a high-level staffing estimate.

Finally, each project developed includes annualized project costs and unit costs. Annualized Total project costs were annualized assuming a 30-year loan with a 3.5 percent interest rate. This annualized cost would be impacted by the financing mechanism determined for the project; for example, if a low-interest loan with a 2 percent interest rate were secured, the annualized cost would decrease from what is shown. Unit costs were developed in \$/MG of finished water produced and \$ per ac-ft of finished water produced. Note that unit costs were not developed for the SSD project, as this is dependent on the CAPP purification costs, which are under development as part of design.

Grant funding for any aspect of the project is not included in this analysis.

7.3 Solvang Advanced Water Purification Facility Project Capital and Operations and Maintenance Costs

As noted in Chapter 4, sizing and production of the Solvang AWPf is as follows:

- AWPf capacity: 1.0 mgd:
 - » Note that the Solvang AWPf is sized for 1.0 mgd of equalized flow in order to capture PWWFs during storm events. Typical secondary effluent flow is closer to the ADWF of 0.59 mgd.
- Annual production (based on ADWF):
 - » IPR = 0.46 mgd (515 AFY).
 - » DPR = 0.43 mgd (482 AFY).

Table 7.8 and Table 7.9 show the total capital and annual O&M costs for the Solvang IPR and DPR projects.

Table 7.8 Solvang Total Project Cost Estimates

Cost Item	Total Project Cost		
	IPR (6 Month Conveyance Pipeline)	IPR (12 Month Conveyance Pipeline)	DPR
Infrastructure	\$38,460,000	\$42,300,000	\$23,660,000
Treatment	\$136,670,000	\$136,670,000	\$175,130,000
Total	\$175,130,000	\$178,970,000	\$199,360,000

If the Solvang permit negotiations are successful, then the large 4.3 MG EQ basin would be removed from the project and the AWPf could be shrunken down to treat ADWF only (reducing capacity from 1 mgd to 0.59 mgd). The net result is an **approximately 60 percent reduction in the total project treatment cost**.

Table 7.9 Solvang Annual O&M Cost Estimates

Cost Item	Annual O&M Cost		
	IPR (6 Month Conveyance Pipeline), \$/year	IPR (12 Month Conveyance Pipeline), \$/year	DPR, \$/year
Infrastructure	\$422,000	\$442,000	\$291,000
Treatment	\$1,087,000	\$1,087,000	\$1,540,000
Total	\$1,509,000	\$1,529,000	\$1,831,000

If the Solvang permit negotiations are successful, then the large 4.3 MG EQ basin would be removed from the project and the AWPf could be shrunken down to treat ADWF only (reducing capacity from 1 mgd to 0.59 mgd). The net result is an **approximately 15 percent reduction in annual O&M cost** due to a smaller operating AWPf.

Table 7.10 and Table 7.11 show the annualized project costs and unit costs for the Solvang IPR and DPR projects.

Table 7.10 Solvang Annualized Total Project Cost Estimates

Cost Item	Annualized Total Project Cost ⁽¹⁾		
	IPR (6 Month Conveyance Pipeline), \$/year	IPR (12 Month Conveyance Pipeline), \$/year	DPR, \$/year
Annualized Total Project Cost	\$9,522,000	\$9,731,000	\$10,839,000

Notes:

(1) Calculated assuming an interest rate of 3.5 percent and annualized over 30 years.

Table 7.11 Solvang Project Unit Cost Estimates

Cost Item	Unit Cost ⁽¹⁾		
	IPR (6 Month Conveyance Pipeline)	IPR (12 Month Conveyance Pipeline)	DPR
\$/ac-ft	\$21,500	\$21,900	\$26,400
\$/MG	\$65,800	\$67,100	\$80,800

Notes:

(1) Calculated using the annualized capital cost, annual O&M cost, and assuming the facility is running at capacity 365 days per year.

If the Solvang permit negotiations are successful, then the large 4.3 MG EQ basin would be removed from the project and the AWPf could be shrunken down to treat ADWF only (reducing capacity from 1 mgd to 0.59 mgd). The net result is an approximately **35 percent reduction in the unit cost**.

7.4 Buellton Advanced Water Purification Facility Project Capital and Operations and Maintenance Costs

As noted in Chapter 4, sizing and production of the Buellton AWPf is as follows:

- AWPf capacity: 0.43 mgd.
- Annual production (based on ADWF):
 - » IPR = 0.33 mgd (370 AFY).
 - » DPR = 0.31 mgd (347 AFY).

Table 7.12 and Table 7.13 show the total capital and annual O&M costs for the Buellton IPR and DPR projects.

Table 7.12 Buellton Total Project Cost Estimates

Cost Item	Total Project Cost		
	IPR (6 Month Conveyance Pipeline)	IPR (12 Month Conveyance Pipeline)	DPR
Infrastructure	\$22,170,000	\$23,820,000	\$16,460,000
Treatment	\$47,910,000	\$47,910,000	\$75,420,000
Total	\$70,080,000	\$71,730,000	\$91,880,000

Table 7.13 Buellton Annual O&M Cost Estimates

Cost Item	Annual O&M Cost		
	IPR (6 Month Conveyance Pipeline), \$/year	IPR (12 Month Conveyance Pipeline), \$/year	DPR, \$/year
Infrastructure	\$169,000	\$177,000	\$117,000
Treatment	\$870,000	\$870,000	\$1,371,000
Total	\$1,037,000	\$1,047,000	\$1,488,000

Table 7.14 and Table 7.15 show the annualized project costs and unit costs for the Solvang IPR and DPR projects.

Table 7.14 Buellton Annualized Total Project Cost Estimates

Cost Item	Annualized Total Project Cost ⁽¹⁾		
	IPR (6 Month Conveyance Pipeline), \$/year	IPR (12 Month Conveyance Pipeline), \$/year	DPR, \$/year
Annualized Total Project Cost	\$3,810,000	\$3,900,000	\$4,996,000

Notes:

(1) Calculated assuming an interest rate of 3.5 percent and annualized over 30 years.

Table 7.15 Buellton Project Unit Cost Estimates

Cost Item	Unit Cost ⁽¹⁾		
	IPR (6 Month Conveyance Pipeline), \$/year	IPR (12 Month Conveyance Pipeline), \$/year	DPR, \$/year
\$/ac-ft	\$13,200	\$13,400	\$18,700
\$/MG	\$40,300	\$41,100	\$57,300

Notes:

(1) Calculated using the annualized capital cost, annual O&M cost, and assuming the facility is running at capacity 365 days per year.

7.5 Solvang/Buellton Combined Advanced Water Purification Facility Project Capital and Operations and Maintenance Costs

As noted in Chapter 4, sizing and production of the Solvang/Buellton Combined AWPf is as follows:

- AWPf capacity: 1.02 mgd.
- Annual production (based on ADWF):
 - » IPR = 0.78 mgd (874 AFY).
 - » DPR = 0.731 mgd (818 AFY).

Table 7.16 and Table 7.17 show the total capital and annual O&M costs for the Solvang/Buellton combined IPR and DPR projects.

Table 7.16 Solvang/Buellton Combined Total Project Cost Estimates

Cost Item	Total Project Cost		
	IPR (6 Month Conveyance Pipeline)	IPR (12 Month Conveyance Pipeline)	DPR
Infrastructure	\$59,930,000	\$61,880,000	\$41,150,000
Treatment	\$137,760,000	\$137,760,000	\$177,990,000
Total	\$197,690,000	\$199,640,000	\$219,140,000

If the Solvang permit negotiations are successful, then the large 4.3 MG EQ basin would be removed from the project, **resulting in an approximately 55 percent reduction in the total project treatment cost.** In the combined project, the AWPf is already sized to treat the ADWF from both WWTPs so there would be no reduction in treatment equipment size.

Table 7.17 Solvang/Buellton Combined Annual O&M Cost Estimates

Cost Item	Annual O&M Cost		
	IPR (6 Month Conveyance Pipeline), \$/year	IPR (12 Month Conveyance Pipeline), \$/year	DPR, \$/year
Infrastructure	\$587,000	\$596,000	\$436,000
Treatment	\$1,310,000	\$1,310,000	\$1,864,000
Total	\$1,897,000	\$1,906,000	\$2,300,000

Table 7.18 and Table 7.19 show the annualized project costs and unit costs for the Solvang/Buellton combined IPR and DPR projects.

Table 7.18 Solvang/Buellton Combined Annualized Total Project Cost Estimates

Cost Item	Annualized Total Project Cost ⁽¹⁾		
	IPR (6 Month Conveyance Pipeline), \$/year	IPR (12 Month Conveyance Pipeline), \$/year	DPR, \$/year
Annualized Total Project Cost	\$10,749,000	\$10,855,000	\$11,915,000

Notes:

(1) Calculated assuming an interest rate of 3.5 percent and annualized over 30 years.

Table 7.19 Solvang/Buellton Combined Project Unit Cost Estimates

Cost Item	Unit Cost ⁽¹⁾		
	IPR (6 Month Conveyance Pipeline), \$/year	IPR (12 Month Conveyance Pipeline), \$/year	DPR, \$/year
\$/ac-ft	\$14,500	\$14,700	\$17,400
\$/MG	\$44,500	\$44,900	\$53,400

Notes:

(1) Calculated using the annualized capital cost, annual O&M cost, and assuming the facility is running at capacity 365 days per year.

If the Solvang permit negotiations are successful, then the large 4.3 MG EQ basin would be removed from the project, **resulting in an approximately 30 percent reduction in the unit costs.**

7.6 Summerland Sanitary District Connection to Carpinteria Sanitary District Capital and Operations and Maintenance Costs

Table 7.20 and Table 7.21 show the total capital and annual O&M costs for the SSD flow transfer projects.

Table 7.20 SSD Total Project Cost Estimates

Cost Item	Total Project Cost	
	0.2 mgd Equalized Flow to CSD	0.47 mgd Equalized Flow to CSD
New Pipe From SSD to CSD	\$6,591,000	\$9,434,000
Upsized CSD Piping	\$151,000	\$644,000
Pump Station	\$1,469,000	\$3,996,000
New 0.47 MG EQ Basin	\$9,120,000	-
Rehabilitate Existing EQ Basin	-	\$441,000
Odor Control System	\$869,000	\$623,000
Screenings and Conveyor Facility	\$1,679,000	\$1,679,000
Total	\$19,880,000	\$16,820,000

Table 7.21 SSD Annual O&M Cost Estimates

Cost Item	Annual O&M Cost	
	0.2 mgd Equalized Flow to CSD (\$/year)	0.47 mgd Equalized Flow to CSD (\$/year)
Power	\$73,000	\$153,000
Annual Maintenance ⁽¹⁾	\$99,000	\$84,000
Odor Control Media Replacement	\$5,000	\$1,000
Total	\$177,000	\$238,000

Notes:

(1) Annual maintenance estimated as 0.5 percent of total capital costs.

Table 7.22 shows the annualized project costs and unit costs for the SSD flow transfer projects. Unit cost was not calculated for this project as this is dependent on the CAPP purification costs, which are under development as part of design.

Table 7.22 SSD Annualized Total Project Cost Estimates

Cost Item	Annualized Total Project Cost ⁽¹⁾	
	0.2 mgd Equalized Flow to CSD (\$/year)	0.47 mgd Equalized Flow to CSD (\$/year)
Annualized Total Project Cost	\$1,261,000	\$1,213,000

Notes:

(1) Calculated assuming an interest rate of 3.5 percent and annualized over 30 years.

7.6.1 Carpinteria Sanitary District Connection Fees

In addition to the project cost estimates as displayed in this report, a comprehensive fiscal analysis needs to be conducted to determine all direct and indirect costs of the public services that are proposed to be assumed by the successor agency if the connection is successful.

7.7 Implementation Timelines

The timeline to implement a potable reuse project can vary depending on the urgency and need, regulatory climate, and specific project details. The following subsections discuss the overall approach to implementing potable reuse projects.

7.7.1 Indirect Potable Reuse Timeline

The following sections describe the timeline for IPR implementation and the key elements for IPR success. The next steps are incorporated into the project implementation phases.

7.7.1.1 Project Timeline

The goal of this IPR implementation timeline and approach is to provide insight into key project elements and how they might fit within an overall project delivery timeline. The project timeline components can be broken into three parts—planning phase, demonstration phase, and implementation phase.

7.7.1.2 Planning Phase

This work represents the initial planning efforts. The next steps that would be part of the planning phase may include:

- Define a financial model and governing approach for a future potable reuse program.
- Refine planning approaches based upon the specific needs of project participants.
- Identify grant funding opportunities. Focus will be on the application timing and components needed to secure funding.
- Produce a US Bureau of Reclamation “compliant” report that can be used for federal grant funding.

The planning phase tasks are detailed on Figure 7.1.

Project Phase	Year						
	1	2	3	4	5	6	7
Planning							
Project Visioning							
Feasibility Study							
Outreach							
Grant Funding							
Implementation							
Permitting							
Pre-Design (Basis of Design Report)							
Design							
Procurement							
Construction							
Operations & Operator Training							
AWTO Training and Certification							
AWPF Full Scale Operations							

Figure 7.1 Potential IPR Implementation Timeline Based on Three Main Project Phases

7.7.1.3 Implementation Phase

The implementation phase includes permitting, as well as design and construction of the project.

Elements of the implementation phase include:

- Environmental permitting is conducted via the CEQA process.
- RWQCB permitting requires preparation of a Title 22 Engineering Report (reviewed and approved by the DDW):
 - » Both permitting tasks will start with the demonstration phase and continue throughout the implementation phase.
 - » It should be noted that the timeline for permitting and approval may fluctuate and are project and agency dependent.
- Produce a Basis of Design Report. This report aids in greater project and cost confidence while also meeting requirements needed for State Revolving Fund funding.

- Project design is completed and the project goes out for bid.
- The project is constructed.

The implementation phase tasks are detailed on Figure 7.1.

7.7.1.4 Operations and Operator Training

The timeline for operator training assumes that all AWTOs will be promoted from within the existing water utility and trained as an AWTO. Given the small number of existing AWTO certified operators, it does not currently make sense to assume these operators can be hired from outside the organization. This also leads to the need to train replacement staff for the operators who transition into the AWTO role.

7.7.1.5 Schedule Risks

Throughout the implementation timeline there are elements that can result in schedule delays or project uncertainty. Some challenge to be aware of are:

- Public perception:
 - » *As a utility implements a potable reuse project, community confidence, understanding, acceptance, and support, along with stakeholder involvement, become essential:*
 - Issues that commonly come up with the public include no-growth concerns, rate impacts, and general concerns over the concept of potable reuse. It is important the project sponsor become aware of the likely concerns in the service area to address these early on.
 - Initiating and maintaining an extensive public engagement campaign is critical.
- Interagency agreements:
 - » *To implement a successful IPR project, a high degree of interagency coordination is needed. An interagency agreement will be needed to define elements of a project including:*
 - Cost sharing.
 - Responsibility for risk and liability.
 - Operational responsibilities.
 - Response to a system failure and/or interruption.
 - Meeting regulatory requirements.
 - » *Developing consensus between multiple agencies can be time consuming. Consequently, this should be an early priority in the project.*

7.7.2 Direct Potable Reuse Timeline

The goal of this DPR implementation timeline and approach is to provide perspective on key project elements and how they might fit within an overall project delivery timeline.

Figure 7.2 shows a general sequence of events typically assumed for DPR implementation. The timeline has been divided into four phases—planning, demonstration, implementation, and operations/operator training. Although these phases are ordered generally in sequence, there is overlap between them and some activities, particularly those associated with implementation and operation and training, continue throughout the life of the project. For example, projects may be required by the DDW to convene an IAP during the planning phase to provide input on project concepts, and the IAP will typically also convene at

key points throughout the project. Another example is with operations. Although the actual operation of a purified water facility wouldn't start until the facility is built, advanced planning for plant staffing and operator training would need to start much earlier to ensure that there are sufficient qualified operators once the AWPf comes online.

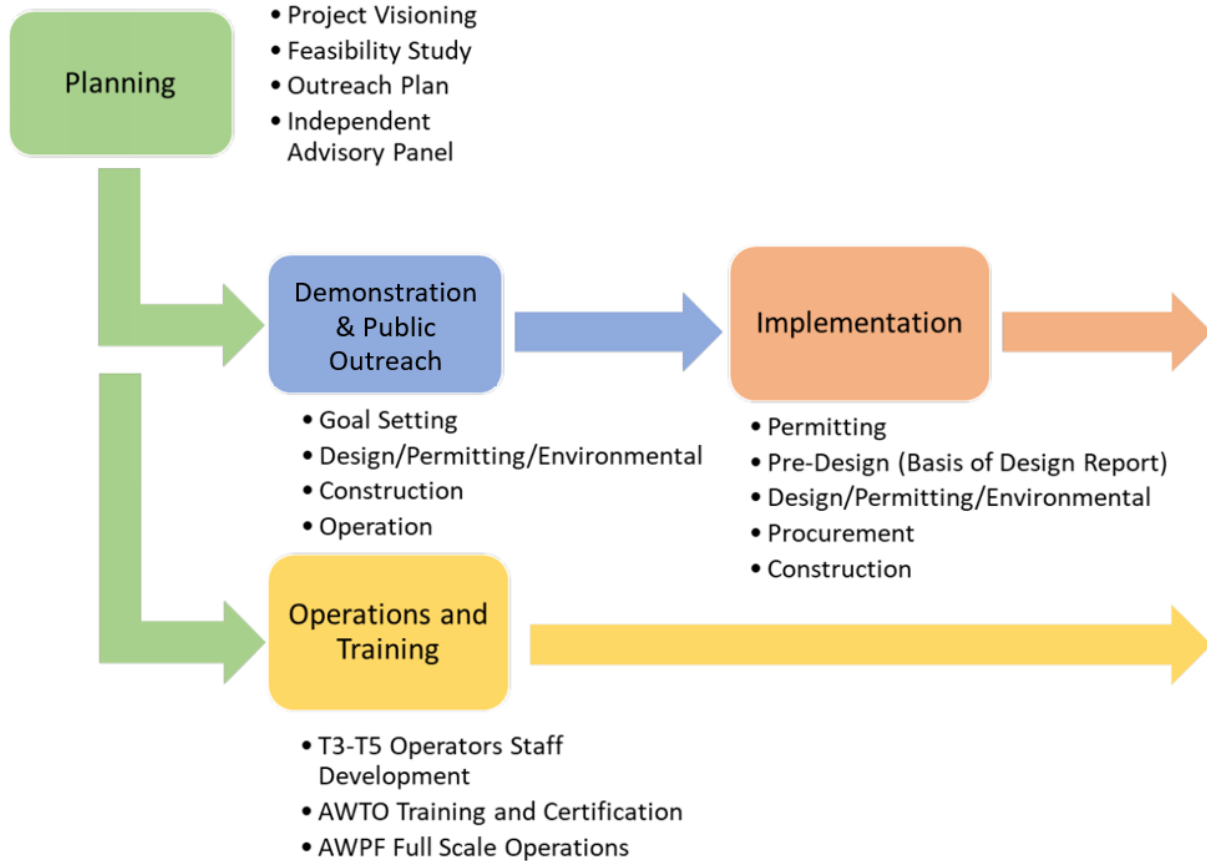

Figure 7.2 Four Main Phases of DPR Implementation

Some key assumptions and considerations incorporated into the development of the DPR project timeline on Figure 7.2 are as follows.

7.7.2.1 Planning Phase

Project visioning is a key component of planning for a DPR project. Visioning starts with clearly laying out and defining the need for the project, i.e., defining the water supply challenge addressed by the project, and quantifying how much water is needed. It is also an opportunity to place the project within the larger planning context and to begin to think about coordination with existing or planned projects and availability and sources of funding. This study herein represents the project visioning and feasibility components of the planning phase of the evaluation, to be followed by outreach and engagement, and National Water Research Institute efforts if the project is selected to progress.

7.7.2.2 Demonstration and Public Outreach Phase

The first step to implementing a demonstration facility is goal setting. In this stage, the project sponsor defines the demonstration goals, which are typically design, permitting, operations, engagement, and innovation. Some examples of demonstration facility goals are:

- Validating the project concept.
- Engaging with the public and stakeholders.
- Demonstrating the ability to effectively operate AWT technologies.
- Researching issues of emerging concern.
- Engaging with regulators.

Defining the timing for a demonstration facility and committing to funding and building a demonstration facility is the first major action item for a DPR project. The demonstration facility will provide information to support the decision to move forward with a full-scale project.

7.7.2.3 Implementation Phase

Typically, a demonstration facility would precede a decision about moving forward with a full-scale project. However, if a project sponsor has full commitment to move forward with a project prior to a demonstration facility, the implementation phase could begin sooner, in parallel with the demonstration phase.

Permitting for a potable reuse project includes several elements. Environmental permitting is conducted via the National Environmental Protection Act and the CEQA process. Projects must also be permitted by the RWQCB, which requires preparation of a Title 22 Engineering Report (with review and approval by DDW). Projects may also require updates of the relevant NPDES discharge permit to accommodate discharge of ROC through an ocean outfall. ROC disposal through deep well injection will require coordination with the appropriate regional EPA office.

7.7.2.4 Operations and Operator Training

The timeline for operator training assumes that all AWTO will be promoted from within the existing water utility and trained as an AWTO. Given the small number of existing AWTO certified operators, it does not currently make sense to assume these operators can be hired from outside the organization. This also leads to the need to train replacement staff for the operators who transition into the AWTO role.

7.7.2.5 Schedule Risks

Throughout the implementation timeline there are elements that can result in schedule delays or increased uncertainty. Some examples of challenges faced by utilities working to implement DPR are:

- Consensus on the project:
 - » *Internal discussion on the project definition, value, and urgency can significantly impact timeline.*

- Water supply need:
 - » *Projects have been deferred due to reduction of drought conditions.*
 - » *If other potential new water sources are in play, these may be preferred under certain supply demand scenarios.*
- Public perception:
 - » *As a utility implements a potable reuse project, community confidence, understanding, acceptance, and support, as well as stakeholder involvement, become essential. However, members of the general public often are not aware of the details of their water supply or the systems in place to bring drinking water to their business and homes, and the mechanisms employed to ensure that the quality of their finished water is protective of public health.*
 - » *Issues that commonly come up with the public include no-growth concerns, rate impacts, and general concern over the concept of potable reuse. Project sponsors should work to understand likely concerns in the service area early on so they can be addressed directly.*
 - » *Initiating and maintaining an extensive public engagement campaign is critical.*
 - » *Early understanding of public support or opposition becomes an important part of the decision-making process.*
- Interutility or interagency agreements:
 - » *To implement a successful DPR project, a high degree of interagency coordination is needed. An interagency agreement, such as a memorandum of understanding, will be needed to define elements of the project, including items such as:*
 - *Cost sharing.*
 - *Responsibility for risk and liability.*
 - *Operational responsibilities.*
 - *Response to system failure and/or interruption.*
 - *Meeting regulatory requirements.*
 - » *Developing consensus between multiple agencies, each with their own governing bodies and stakeholders, can be time consuming. This should be a priority early in the project to avoid creating a roadblock when the project is further along.*
- Regulatory uncertainty:
 - » *The lack of precedent for implementation of a TWA project in California may lead to a slow permitting process as DDW navigates this process.*

The example timeline shown on Figure 7.3 assumes the project sponsor is committed to implementing the project and is actively and consistently working to move the project forward. However, it should be well understood that a decision on whether to move forward with design and construction of a full-scale facility would be made after a demonstration facility has been built and supporting data collected.

Project Phase	Year										
	1	2	3	4	5	6	7	8	9	10	11
Planning											
Project Visioning											
Feasibility Study											
Outreach Plan											
Independent Advisory Panel											
Demonstration & Public Outreach											
Goal Setting											
Design											
Construction											
Operation											
Implementation											
Permitting											
Pre-Design (Basis of Design Report)											
Design											
Procurement											
Construction											
Operations & Operator Training											
T3 - T5 Operators Staff Development											
AWTO Training and Certification											
AWPF Full Scale Operations											

Figure 7.3 Potential DPR Implementation Timeline Based on Four Main Project Phases

7.7.3 Summerland Sanitary District Implementation

The implementation of an SSD water reuse project has two aspects:

1. The CAPP is under design. That design allows for increased flows to be captured and purified. No potable reuse implementation plan is needed from the standpoint of wastewater treatment or purification.
2. The integration of the SSD collection system into the CSD system will require extensive further study to examine and confirm alignments, evaluate permitting challenges, develop preliminary designs, refine costs, and develop the critical interagency agreements. Details of those efforts are beyond the scope of this study.

7.8 Next Steps

The intent of this study was to assess the feasibility for implementing IPR or DPR-related projects at selected utilities within the County. Should any of these studied projects move forward, the following subsections detail some next steps that could be taken to progress a project.

7.8.1 Solvang and Buellton Next Steps

This study focused upon the treatment and infrastructure necessary to implement IPR or DPR projects. There are other elements of a DPR or IPR project that require further evaluation and cost analysis, which could be done as part of next steps should any iteration of the Solvang and Buellton projects move forward towards implementation. These include:

- **SCP:** This element is required. The SCP builds upon existing industrial waste pretreatment programs and is required by DDW for a DPR project.
- **Pilot testing of treatment technology:** This element is optional, but highly beneficial for IPR. It is a requirement for DPR. Pilot testing of the proposed advanced treatment systems can be used to (a) refine design criteria, (b) train operations staff, (c) public engagement, and (d) regulatory permitting.
- **IAP:** An IAP is required by DDW for a DPR project but not for an IPR project. Such an IAP would have experts in various types of engineering and public health and provide valuable independent guidance to a DPR project.
- **CEQA reporting and other required environmental documentation:** Required.
- **Development of an operator training program:** This is required for any IPR or DPR project. DDW will require a robust operations staff with AWT certification for both IPR and DPR projects.
- **Additional groundwater modeling and monitoring:** This is required for any IPR project. Should an IPR project move forward, a cohesive understanding of active drinking water wells within the project area needs to be developed. In addition, further modeling and monitoring needs to be conducted to confirm injection well placement.

In addition to the general items above, some specific items for the Solvang project were identified through discussion with city staff and ongoing permitting work with the RWQCB.

- Optimization of AWWPF and EQ basin sizing pending results of permitting negotiations:
 - » *As noted throughout the report, Solvang is working with the RWQCB to determine appropriate concentration-based discharge limits for several parameters/constituents. At the time of project definition for this study, it was assumed that all wastewater effluent flow needs to be captured and treated at the AWWPF. The result is a large (4.3 MG) EQ basin and oversized AWWPF, both of which are very costly.*
 - » *If permitting negotiations are successful, and not all effluent needs to be captured, the size of the EQ basin and AWWPF could shrink significantly, reducing capital costs as much as 60 percent, with subsequent O&M savings as well.*
 - » *Further analysis should be performed to determine optimal AWWPF sizing once permit negotiations are completed.*

- Further study on ROC discharge:
 - » *Consideration of other ROC options, aside from deep well injection.*
 - » *Includes, but is not limited to, a regional brine line for ocean disposal of ROC, or collection of ROC and trucking to a disposal site. It is anticipated that such a regional brine line would be more costly than the deep well injection reviewed in this report.*
 - » *Pertaining to deep well injection, exploratory boring and permitting analysis is needed prior to proceeding with design/implementation of potable reuse.*

7.8.2 Summerland Sanitary District Next Steps

As the nature of the SSD project differs from implementing a new AWWP facility, the following were identified as specific next steps to this project.

- Identification of alternative available land to site the EQ basin and other required infrastructure:
 - » *The WWTP site may be vulnerable to cliff erosion due to sea-level rise.*
 - » *Properties were unable to be identified during this study but should be considered in the future to mitigate climate change risks.*
- Follow-up study on utilizing existing WWTP assets for flow transfer including the following:
 - » *Existing tankage (aside from the EQ basin) for flow EQ including the aeration tanks and secondary clarifiers.*
 - » *Existing aeration equipment for mixing and potentially odor control.*
 - » *Existing pumps.*
 - » *Existing emergency generator.*
 - » *Existing sampling and monitoring equipment and supervisory control and data acquisition system.*
- Additional flow monitoring and collection system modeling to determine the potential for flow segregation to the CSD collection system:
 - » *SSD wastewater on the eastern side of the system may be able to be directed towards the CSD system using the existing SSD Lift Station No. 3.*
 - » *Understanding where areas of the SSD flow can be directed towards the CSD system without pumping the water to the existing WWTP site can reduce EQ requirements and potentially save on power costs.*
- O&M cost analysis to understand savings associated with converting the WWTP site into an EQ basin and pump station:
 - » *Understand the power reduction at the WWTP.*
 - » *Understand the staffing reduction at the WWTP.*
 - » *Evaluate impact of reductions related to WWTP and increases related to CSD conversion as they apply to SSD customer rates.*

APPENDIX A **WASTEWATER UTILITY QUESTIONNAIRE**

Parameter	City of Buellton	Carpinteria Sanitary District	Goleta Sanitary District	City of Guadalupe	Laguna County Sanitation District	City of Lompoc	Los Alamos Community Services District
Nutrient Removal	Nitrification	Nitrification	No Nutrient Removal	Nitrification/Denitrification	Nitrification/Denitrification	Nitrification/Denitrification	No Nutrient Removal, Facultative Ponds
Tertiary Filtration	No Filtration	No Filtration	Media or Cloth Filtration	No Filtration	Membrane Filtration	Media or Cloth Filtration	No Filtration
Disinfection	No Disinfection	Chlorination	Chlorination	No Disinfection	UV	UV	No Disinfection
Average Dry Weather Flow (MGD)	0.5	1.14	4.0	0.82	1.7	3.06	0.12
Is flow equalized?	Yes	No	Yes	No	Yes	Yes	Yes
Effluent Discharge Location	Land Application	Ocean Outfall	Ocean Outfall	Land Application	Land Application	Surface Water Discharge	Land Application
Does your facility discharge to a location with a minimum flow requirement?	No	No	No	No	No	Yes, can only divert 4% of flow	Yes: BOD, TSS, Settleable Solids, pH
Does your utility have a water reuse program implemented currently?	No	Not currently implemented, but planned for 2025	Yes	Yes	Yes	Not currently implemented, but planned for	No
Average (current or near future) recycled water flow (MGD or gpd)	-	1.0 MGD	1.25 MGD	0.74 MGD	1.7 MGD	0	-
Is the recycled water flow equalized and constant or a variable flow?	N/A, no program in place	Flow to be equalized for future IPR project	Variable	Variable	Equalized and constant	Variable	Variable
What is the current end use of the recycled water?	N/A, no program in place	Near future will be Potable Water Reuse	Title 22, Irrigation Application	Title 22, Irrigation Application	Title 22, Irrigation Application	Title 22, Irrigation Application; Title 22, Industry Application	N/A, no program in place
If no program currently implemented or planned, does your utility have interest in implementing a water reuse program?	Need more information to decide	Program already underway for IPR	Yes, interested in expanding water reuse	-	Detailed IPR analysis underway as part of a separate project	No, limited to 62K gpd. Cannot sell enough recycled water to recover testing/compliance costs	Yes
When do you anticipate a water supply deficit in your community?	No foreseeable deficit, 15 or more years	Experiencing a deficit now	Within 10 years	No foreseeable deficit	-	15 or more years	15 or more years

Parameter	Mission Hills CSD	Montecito Sanitary District	City of Santa Barbara	City of Santa Maria	Santa Ynez Band of Chumash Indians	City of Solvang	Summerland Sanitary District
Nutrient Removal	Nitrification/Denitrification	Nitrification	Nitrification/Denitrification	No Nutrient Removal	Nitrification/Denitrification	Nitrification	Nitrification/Denitrification
Tertiary Filtration	-	No Filtration	Media or Cloth Filtration	No Filtration	Membrane Filtration	No Filtration	Media or Cloth Filtration
Disinfection	No Disinfection	Chlorination	Chlorination	No Disinfection	Chlorination	No Disinfection	Chlorination
Average Dry Weather Flow (MGD)	0.19	0.7	7.0	7.3	0.098	0.7	0.17
Is flow equalized?	No	No	No	No	No	No	Yes
Effluent Discharge Location	Land Application	Ocean Outfall	Ocean Outfall	Percolation Ponds	Surface Water Discharge/Land Application	Percolation Ponds	Ocean Outfall
Does your facility discharge to a location with a minimum flow requirement?	No	No	No	No	No	No	No
Does your utility have a water reuse program implemented currently?	No	Not currently implemented, but planned for: pursuing a variety of reuse options (NPR, IPR, DPR). Most promising is IPR with Carpinteria SD.	Yes	No	Yes	No	No
Average recycled water flow (MGD or gpd)	-	-	0.6 MGD	-	0.085	-	-
Is the recycled water flow equalized and constant or a variable flow?	N/A, no program in place	N/A, no program in place	Equalized and constant	N/A, no program in place	Variable	N/A, no program in place	N/A, no program in place
What is the current end use of the recycled water?	N/A, no program in place	N/A, no program in place	Title 22, Irrigation Application	N/A, no program in place	Title 22, Irrigation Application; Title 22, Industry Application	N/A, no program in place	N/A, no program in place
If no program currently implemented or planned, does your utility have interest in implementing a water reuse program?	-	Program already analyzed.	Program already analyzed.	No, effluent is percolated into the same groundwater basin that is used as the City's groundwater supply, essentially, the effluent is reused.	-	Yes	Need more information to decide
When do you anticipate a water supply deficit in your community?	No foreseeable deficit	-	-	No foreseeable deficit	No foreseeable deficit	-	Within 10 years



Wastewater Utility Questionnaire

Countywide Potable Reuse Evaluation

County of Santa Barbara | 130 E Victoria Street, Suite 200, Santa Barbara, CA 93101

Phone: (805) 568-3440

Please complete this form to the best of your ability and return via email to Matt Young (mcyoung@countyofsb.org) by Friday, March 3rd 2023.

General Information

Utility Name:	CITY OF BUELLTON
Wastewater Treatment Plant Name:	COB WWTP
Wastewater Treatment Plant Address:	79 Industrial Way, Buellton CA 93427

Existing Wastewater System

Wastewater Treatment:

Nutrient Removal:	<input checked="" type="checkbox"/> Nitrification <input type="checkbox"/> Nit/Denit <input type="checkbox"/> No Nutrient Removal
Tertiary Filtration:	<input type="checkbox"/> Media or Cloth Filtration <input type="checkbox"/> Membrane Filtration <input checked="" type="checkbox"/> No Filtration
Disinfection:	<input type="checkbox"/> Chlorination <input type="checkbox"/> UV <input checked="" type="checkbox"/> No Disinfection

Effluent Flow:

Average Dry Weather Flow (MGD):	[INPUT VALUE HERE]
Is flow equalized?	<input checked="" type="checkbox"/> Yes <input type="checkbox"/> No
Effluent Discharge Location:	<input type="checkbox"/> Surface Water Discharge <input type="checkbox"/> Ocean Outfall <input checked="" type="checkbox"/> Land Application
Does your facility discharge to a location with a minimum flow requirement? <i>If yes, note body of water and flow requirement.</i>	<input type="checkbox"/> Yes <input checked="" type="checkbox"/> No [NOTE FLOW REQUIREMENTS HERE, IF APPLICABLE]



Wastewater Utility Questionnaire

Countywide Potable Reuse Evaluation

County of Santa Barbara | 130 E Victoria Street, Suite 200, Santa Barbara, CA 93101

Phone: (805) 568-3440

Water Reuse

Does your utility have a water reuse program implemented currently?	<input type="checkbox"/> Yes <input checked="" type="checkbox"/> No <input type="checkbox"/> Not currently implemented, but planned for... [INPUT DATE HERE]
Average recycled water flow (MGD or gpd): <i>If project is planned, please note anticipated flow.</i>	[INPUT VALUE HERE]
Is the recycled water flow equalized and constant or a variable flow? <i>If project is planned, please note anticipated flow type.</i>	<input type="checkbox"/> Equalized and constant <input type="checkbox"/> Variable <input checked="" type="checkbox"/> N/A, no program in place
What is the current end use of the recycled water? <i>If project is planned, please note anticipated end use.</i>	<input type="checkbox"/> Potable Water Reuse <input type="checkbox"/> Title 22, Irrigation Application <input type="checkbox"/> Title 22, Industry Application <input type="checkbox"/> Non-Title 22 Application <input checked="" type="checkbox"/> N/A, no program in place
If no program currently implemented or planned, does your utility have interest in implementing a water reuse program?	<input type="checkbox"/> Yes <input type="checkbox"/> No <input checked="" type="checkbox"/> Need more information to decide, such as... [INPUT REASONS HERE]

Drinking Water Supply

When do you anticipate a water supply deficit in your community?	<input checked="" type="checkbox"/> No foreseeable deficit <input type="checkbox"/> Experiencing a deficit now <input type="checkbox"/> Within 5-years <input type="checkbox"/> Within 10-years <input checked="" type="checkbox"/> 15 or more years
--	--



Wastewater Utility Questionnaire

Countywide Potable Reuse Evaluation

County of Santa Barbara | 130 E Victoria Street, Suite 200, Santa Barbara, CA 93101

Phone: (805) 568-3440

Please complete this form to the best of your ability and return via email to Matt Young (mcyoung@countyofsb.org) by Friday, March 3rd 2023.

General Information

Utility Name:	Carpinteria Sanitary District
Wastewater Treatment Plant Name:	CSD Wastewater Treatment Facility
Wastewater Treatment Plant Address:	5351 Sixth St., Carpinteria, CA 93013

Existing Wastewater System

Wastewater Treatment:

Nutrient Removal:	<input checked="" type="checkbox"/> Nitrification <input type="checkbox"/> Nit/Denit <input type="checkbox"/> No Nutrient Removal
Tertiary Filtration:	<input type="checkbox"/> Media or Cloth Filtration <input type="checkbox"/> Membrane Filtration <input checked="" type="checkbox"/> No Filtration
Disinfection:	<input checked="" type="checkbox"/> Chlorination <input type="checkbox"/> UV <input type="checkbox"/> No Disinfection

Effluent Flow:

Average Dry Weather Flow (MGD):	[INPUT VALUE HERE]
Is flow equalized?	<input type="checkbox"/> Yes <input checked="" type="checkbox"/> No
Effluent Discharge Location:	<input type="checkbox"/> Surface Water Discharge <input checked="" type="checkbox"/> Ocean Outfall <input type="checkbox"/> Land Application
Does your facility discharge to a location with a minimum flow requirement? <i>If yes, note body of water and flow requirement.</i>	<input type="checkbox"/> Yes <input checked="" type="checkbox"/> No [NOTE FLOW REQUIREMENTS HERE, IF APPLICABLE]



Wastewater Utility Questionnaire

Countywide Potable Reuse Evaluation

County of Santa Barbara | 130 E Victoria Street, Suite 200, Santa Barbara, CA 93101

Phone: (805) 568-3440

Water Reuse

<p>Does your utility have a water reuse program implemented currently?</p>	<p><input type="checkbox"/> Yes</p> <p><input type="checkbox"/> No</p> <p><input checked="" type="checkbox"/> Not currently implemented, but planned for... [2025]</p>
<p>Average recycled water flow (MGD or gpd): <i>If project is planned, please note anticipated flow.</i></p>	<p>1.0 MGD</p>
<p>Is the recycled water flow equalized and constant or a variable flow? <i>If project is planned, please note anticipated flow type.</i></p>	<p><input type="checkbox"/> Equalized and constant</p> <p><input type="checkbox"/> Variable</p> <p><input checked="" type="checkbox"/> N/A, no program in place</p>
<p>What is the current end use of the recycled water? <i>If project is planned, please note anticipated end use.</i></p>	<p><input checked="" type="checkbox"/> Potable Water Reuse</p> <p><input type="checkbox"/> Title 22, Irrigation Application</p> <p><input type="checkbox"/> Title 22, Industry Application</p> <p><input type="checkbox"/> Non-Title 22 Application</p> <p><input type="checkbox"/> N/A, no program in place</p>
<p>If no program currently implemented or planned, does your utility have interest in implementing a water reuse program?</p>	<p><input type="checkbox"/> Yes</p> <p><input type="checkbox"/> No</p> <p><input checked="" type="checkbox"/> Need more information to decide, such as... [CVWD to fund project as new water supply]</p>

Drinking Water Supply

<p>When do you anticipate a water supply deficit in your community?</p>	<p><input type="checkbox"/> No foreseeable deficit</p> <p><input checked="" type="checkbox"/> Experiencing a deficit now</p> <p><input type="checkbox"/> Within 5-years</p> <p><input type="checkbox"/> Within 10-years</p> <p><input type="checkbox"/> 15 or more years</p>
---	--



Wastewater Utility Questionnaire

Countywide Potable Reuse Evaluation

County of Santa Barbara | 130 E Victoria Street, Suite 200, Santa Barbara, CA 93101

Phone: (805) 568-3440

Please complete this form to the best of your ability and return via email to Matt Young (mcyoung@countyofsb.org) by Friday, March 3rd 2023.

General Information

Utility Name:	GOLETA SANITARY DISTRICT
Wastewater Treatment Plant Name:	[GSD WATER RESOURCE RECOVERY FACILITY]
Wastewater Treatment Plant Address:	1 WILLIAM MOFFETT PL., GOLETA, CA, 93117]

Existing Wastewater System

Wastewater Treatment:

Nutrient Removal:	<input type="checkbox"/> Nitrification <input type="checkbox"/> Nit/Denit <input checked="" type="checkbox"/> No Nutrient Removal
Tertiary Filtration:	<input checked="" type="checkbox"/> Media or Cloth Filtration <input type="checkbox"/> Membrane Filtration <input type="checkbox"/> No Filtration
Disinfection:	<input checked="" type="checkbox"/> Chlorination <input type="checkbox"/> UV <input type="checkbox"/> No Disinfection

Effluent Flow:

Average Dry Weather Flow (MGD):	4.0MGD
Is flow equalized?	<input checked="" type="checkbox"/> Yes <input type="checkbox"/> No
Effluent Discharge Location:	<input type="checkbox"/> Surface Water Discharge <input checked="" type="checkbox"/> Ocean Outfall <input type="checkbox"/> Land Application
Does your facility discharge to a location with a minimum flow requirement? <i>If yes, note body of water and flow requirement.</i>	<input type="checkbox"/> Yes <input checked="" type="checkbox"/> No [NOTE FLOW REQUIREMENTS HERE, IF APPLICABLE]



Wastewater Utility Questionnaire

Countywide Potable Reuse Evaluation

County of Santa Barbara | 130 E Victoria Street, Suite 200, Santa Barbara, CA 93101

Phone: (805) 568-3440

Water Reuse

<p>Does your utility have a water reuse program implemented currently?</p>	<input checked="" type="checkbox"/> Yes <input type="checkbox"/> No <input type="checkbox"/> Not currently implemented, but planned for... [INPUT DATE HERE]
<p>Average recycled water flow (MGD or gpd): <i>If project is planned, please note anticipated flow.</i></p>	<p>1.25MGD</p>
<p>Is the recycled water flow equalized and constant or a variable flow? <i>If project is planned, please note anticipated flow type.</i></p>	<input type="checkbox"/> Equalized and constant <input checked="" type="checkbox"/> Variable <input type="checkbox"/> N/A, no program in place
<p>What is the current end use of the recycled water? <i>If project is planned, please note anticipated end use.</i></p>	<input type="checkbox"/> Potable Water Reuse <input checked="" type="checkbox"/> Title 22, Irrigation Application <input type="checkbox"/> Title 22, Industry Application <input type="checkbox"/> Non-Title 22 Application <input type="checkbox"/> N/A, no program in place
<p>If no program currently implemented or planned, does your utility have interest in implementing a water reuse program?</p>	<input checked="" type="checkbox"/> Yes <input type="checkbox"/> No <input type="checkbox"/> Need more information to decide, such as... INTERESTED IN EXPANDING REUSE PROGRAM

Drinking Water Supply

<p>When do you anticipate a water supply deficit in your community?</p>	<input type="checkbox"/> No foreseeable deficit <input type="checkbox"/> Experiencing a deficit now <input type="checkbox"/> Within 5-years <input checked="" type="checkbox"/> Within 10-years <input type="checkbox"/> 15 or more years
---	---



Wastewater Utility Questionnaire

Countywide Potable Reuse Evaluation

County of Santa Barbara | 130 E Victoria Street, Suite 200, Santa Barbara, CA 93101

Phone: (805) 568-3440

Please complete this form to the best of your ability and return via email to Matt Young (mcyoung@countyofsb.org) by Friday, March 3rd 2023.

General Information

Utility Name:	City of Guadalupe
Wastewater Treatment Plant Name:	Wastewater Treatment Plant
Wastewater Treatment Plant Address:	5125 West Main Street, Guadalupe, CA 93434

Existing Wastewater System

Wastewater Treatment:

Nutrient Removal:	<input type="checkbox"/> Nitrification <input checked="" type="checkbox"/> Nit/Denit <input type="checkbox"/> No Nutrient Removal
Tertiary Filtration:	<input type="checkbox"/> Media or Cloth Filtration <input type="checkbox"/> Membrane Filtration <input checked="" type="checkbox"/> No Filtration
Disinfection:	<input type="checkbox"/> Chlorination <input type="checkbox"/> UV <input checked="" type="checkbox"/> No Disinfection

Effluent Flow:

Average Dry Weather Flow (MGD):	0.82
Is flow equalized?	<input type="checkbox"/> Yes <input checked="" type="checkbox"/> No
Effluent Discharge Location:	<input type="checkbox"/> Surface Water Discharge <input type="checkbox"/> Ocean Outfall <input checked="" type="checkbox"/> Land Application
Does your facility discharge to a location with a minimum flow requirement? <i>If yes, note body of water and flow requirement.</i>	<input type="checkbox"/> Yes <input checked="" type="checkbox"/> No [NOTE FLOW REQUIREMENTS HERE, IF APPLICABLE]



Wastewater Utility Questionnaire

Countywide Potable Reuse Evaluation

County of Santa Barbara | 130 E Victoria Street, Suite 200, Santa Barbara, CA 93101

Phone: (805) 568-3440

Water Reuse

Does your utility have a water reuse program implemented currently?	<input checked="" type="checkbox"/> Yes <input type="checkbox"/> No <input type="checkbox"/> Not currently implemented, but planned for... [INPUT DATE HERE]
Average recycled water flow (MGD or gpd): <i>If project is planned, please note anticipated flow.</i>	0.74
Is the recycled water flow equalized and constant or a variable flow? <i>If project is planned, please note anticipated flow type.</i>	<input type="checkbox"/> Equalized and constant <input checked="" type="checkbox"/> Variable <input type="checkbox"/> N/A, no program in place
What is the current end use of the recycled water? <i>If project is planned, please note anticipated end use.</i>	<input type="checkbox"/> Potable Water Reuse <input checked="" type="checkbox"/> Title 22, Irrigation Application <input type="checkbox"/> Title 22, Industry Application <input type="checkbox"/> Non-Title 22 Application <input type="checkbox"/> N/A, no program in place
If no program currently implemented or planned, does your utility have interest in implementing a water reuse program?	<input type="checkbox"/> Yes <input type="checkbox"/> No <input type="checkbox"/> Need more information to decide, such as... [INPUT REASONS HERE]

Drinking Water Supply

When do you anticipate a water supply deficit in your community?	<input checked="" type="checkbox"/> No foreseeable deficit <input type="checkbox"/> Experiencing a deficit now <input type="checkbox"/> Within 5-years <input type="checkbox"/> Within 10-years <input type="checkbox"/> 15 or more years
--	---



Wastewater Utility Questionnaire

Countywide Potable Reuse Evaluation

County of Santa Barbara | 130 E Victoria Street, Suite 200, Santa Barbara, CA 93101

Phone: (805) 568-3440

Please complete this form to the best of your ability and return via email to Matt Young (mcyoung@countyofsb.org) by Friday, March 3rd 2023.

General Information

Utility Name:	Laguna County Sanitation District
Wastewater Treatment Plant Name:	Laguna County Sanitation District
Wastewater Treatment Plant Address:	620 W Foster Road, Santa Maria, CA, 93455

Existing Wastewater System

Wastewater Treatment:

Nutrient Removal:	<input type="checkbox"/> Nitrification <input checked="" type="checkbox"/> Nit/Denit <input type="checkbox"/> No Nutrient Removal
Tertiary Filtration:	<input type="checkbox"/> Media or Cloth Filtration <input checked="" type="checkbox"/> Membrane Filtration <input type="checkbox"/> No Filtration
Disinfection:	<input type="checkbox"/> Chlorination <input checked="" type="checkbox"/> UV <input type="checkbox"/> No Disinfection

Effluent Flow:

Average Dry Weather Flow (MGD):	3.7 MGD
Is flow equalized?	<input checked="" type="checkbox"/> Yes <input type="checkbox"/> No
Effluent Discharge Location:	<input type="checkbox"/> Surface Water Discharge <input type="checkbox"/> Ocean Outfall <input checked="" type="checkbox"/> Land Application
Does your facility discharge to a location with a minimum flow requirement? <i>If yes, note body of water and flow requirement.</i>	<input type="checkbox"/> Yes <input checked="" type="checkbox"/> No



Wastewater Utility Questionnaire

Countywide Potable Reuse Evaluation

County of Santa Barbara | 130 E Victoria Street, Suite 200, Santa Barbara, CA 93101

Phone: (805) 568-3440

Water Reuse

Does your utility have a water reuse program implemented currently? <i>If project is planned, please note anticipated flow.</i>	<input checked="" type="checkbox"/> Yes <input type="checkbox"/> No <input type="checkbox"/> Not currently implemented, but planned for... June 2005
Average recycled water flow (MGD or gpd): <i>If project is planned, please note anticipated flow type.</i>	1.7 MGD
Is the recycled water flow equalized and constant or a variable flow? <i>If project is planned, please note anticipated flow type.</i>	<input checked="" type="checkbox"/> Equalized and constant <input type="checkbox"/> Variable <input type="checkbox"/> N/A, no program in place
What is the current end use of the recycled water? <i>If project is planned, please note anticipated end use.</i>	<input type="checkbox"/> Potable Water Reuse <input checked="" type="checkbox"/> Title 22, Irrigation Application <input type="checkbox"/> Title 22, Industry Application <input type="checkbox"/> Non-Title 22 Application <input type="checkbox"/> N/A, no program in place
If no program currently implemented or planned, does your utility have interest in implementing a water reuse program?	<input checked="" type="checkbox"/> Yes <input type="checkbox"/> No <input type="checkbox"/> Need more information to decide, such as... Interested in an IPR option as volume of sewage increases and current users/storage is limited.

Drinking Water Supply

When do you anticipate a water supply deficit in your community?	<input type="checkbox"/> No foreseeable deficit <input type="checkbox"/> Experiencing a deficit now <input type="checkbox"/> Within 5-years <input type="checkbox"/> Within 10-years <input type="checkbox"/> 15 or more years
--	--



Wastewater Utility Questionnaire

Countywide Potable Reuse Evaluation

County of Santa Barbara | 130 E Victoria Street, Suite 200, Santa Barbara, CA 93101

Phone: (805) 568-3440

Please complete this form to the best of your ability and return via email to Matt Young (mcyoung@countyofsb.org) by Friday, March 3rd 2023.

General Information

Utility Name:	City of Lompoc
Wastewater Treatment Plant Name:	Lompoc Regional Wastewater Reclamation Plant
Wastewater Treatment Plant Address:	1801 W Central Ave. Lompoc, CA 93436

Existing Wastewater System

Wastewater Treatment:

Nutrient Removal:	<input type="checkbox"/> Nitrification <input checked="" type="checkbox"/> Nit/Denit <input type="checkbox"/> No Nutrient Removal
Tertiary Filtration:	<input checked="" type="checkbox"/> Media or Cloth Filtration <input type="checkbox"/> Membrane Filtration <input type="checkbox"/> No Filtration
Disinfection:	<input type="checkbox"/> Chlorination <input checked="" type="checkbox"/> UV <input type="checkbox"/> No Disinfection

Effluent Flow:

Average Dry Weather Flow (MGD):	3.06
Is flow equalized?	<input checked="" type="checkbox"/> Yes <input type="checkbox"/> No
Effluent Discharge Location:	<input checked="" type="checkbox"/> Surface Water Discharge <input type="checkbox"/> Ocean Outfall <input type="checkbox"/> Land Application
Does your facility discharge to a location with a minimum flow requirement? <i>If yes, note body of water and flow requirement.</i>	<input checked="" type="checkbox"/> Yes <input type="checkbox"/> No Can only divert 4% of flow



Wastewater Utility Questionnaire

Countywide Potable Reuse Evaluation

County of Santa Barbara | 130 E Victoria Street, Suite 200, Santa Barbara, CA 93101

Phone: (805) 568-3440

Water Reuse

Does your utility have a water reuse program implemented currently?	<input type="checkbox"/> Yes <input type="checkbox"/> No <input checked="" type="checkbox"/> Not currently implemented, but planned for... [INPUT DATE HERE]
Average recycled water flow (MGD or gpd): <i>If project is planned, please note anticipated flow.</i>	0
Is the recycled water flow equalized and constant or a variable flow? <i>If project is planned, please note anticipated flow type.</i>	<input type="checkbox"/> Equalized and constant <input checked="" type="checkbox"/> Variable <input type="checkbox"/> N/A, no program in place
What is the current end use of the recycled water? <i>If project is planned, please note anticipated end use.</i>	<input type="checkbox"/> Potable Water Reuse <input checked="" type="checkbox"/> Title 22, Irrigation Application <input checked="" type="checkbox"/> Title 22, Industry Application <input type="checkbox"/> Non-Title 22 Application <input type="checkbox"/> N/A, no program in place
If no program currently implemented or planned, does your utility have interest in implementing a water reuse program?	<input type="checkbox"/> Yes <input checked="" type="checkbox"/> No <input type="checkbox"/> Need more information to decide, such as... Limited to 62k gpd. We cannot sell enough recycled water to recover testing/compliance costs.

Drinking Water Supply

When do you anticipate a water supply deficit in your community?	<input type="checkbox"/> No foreseeable deficit <input type="checkbox"/> Experiencing a deficit now <input type="checkbox"/> Within 5-years <input type="checkbox"/> Within 10-years <input checked="" type="checkbox"/> 15 or more years
--	---



Wastewater Utility Questionnaire

Countywide Potable Reuse Evaluation

County of Santa Barbara | 130 E Victoria Street, Suite 200, Santa Barbara, CA 93101

Phone: (805) 568-3440

Please complete this form to the best of your ability and return via email to Matt Young (mcyoung@countyofsb.org) by Friday, March 3rd 2023.

General Information

Utility Name:	Los Alamos Community Services District
Wastewater Treatment Plant Name:	Los Alamos Wastewater Treatment Plant
Wastewater Treatment Plant Address:	8690 Bell Street

Existing Wastewater System

Wastewater Treatment:

Nutrient Removal:	<input type="checkbox"/> Nitrification <input type="checkbox"/> Nit/Denit <input checked="" type="checkbox"/> No Nutrient Removal Facultative Ponds
Tertiary Filtration:	<input type="checkbox"/> Media or Cloth Filtration <input type="checkbox"/> Membrane Filtration <input checked="" type="checkbox"/> No Filtration
Disinfection:	<input type="checkbox"/> Chlorination <input type="checkbox"/> UV <input checked="" type="checkbox"/> No Disinfection

Effluent Flow:

Average Dry Weather Flow (MGD):	121,416 GPD
Is flow equalized?	<input checked="" type="checkbox"/> Yes <input type="checkbox"/> No
Effluent Discharge Location:	<input type="checkbox"/> Surface Water Discharge <input type="checkbox"/> Ocean Outfall <input checked="" type="checkbox"/> Land Application
Does your facility discharge to a location with a minimum flow requirement? <i>If yes, note body of water and flow requirement.</i>	<input checked="" type="checkbox"/> Yes <input type="checkbox"/> No BOD, Total Suspended Solids, Settleable Solids, pH



Wastewater Utility Questionnaire

Countywide Potable Reuse Evaluation

County of Santa Barbara | 130 E Victoria Street, Suite 200, Santa Barbara, CA 93101

Phone: (805) 568-3440

Water Reuse

Does your utility have a water reuse program implemented currently?	<input type="checkbox"/> Yes <input checked="" type="checkbox"/> No <input type="checkbox"/> Not currently implemented, but planned for... [INPUT DATE HERE]
Average recycled water flow (MGD or gpd): <i>If project is planned, please note anticipated flow.</i>	120,067 Gallons Per Day
Is the recycled water flow equalized and constant or a variable flow? <i>If project is planned, please note anticipated flow type.</i>	<input type="checkbox"/> Equalized and constant <input checked="" type="checkbox"/> Variable <input type="checkbox"/> N/A, no program in place
What is the current end use of the recycled water? <i>If project is planned, please note anticipated end use.</i>	<input type="checkbox"/> Potable Water Reuse <input type="checkbox"/> Title 22, Irrigation Application <input type="checkbox"/> Title 22, Industry Application <input type="checkbox"/> Non-Title 22 Application <input checked="" type="checkbox"/> N/A, no program in place
If no program currently implemented or planned, does your utility have interest in implementing a water reuse program?	<input checked="" type="checkbox"/> Yes <input type="checkbox"/> No <input type="checkbox"/> Need more information to decide, such as...

Drinking Water Supply

When do you anticipate a water supply deficit in your community?	<input type="checkbox"/> No foreseeable deficit <input type="checkbox"/> Experiencing a deficit now <input type="checkbox"/> Within 5-years <input type="checkbox"/> Within 10-years <input checked="" type="checkbox"/> 15 or more years
--	---



Wastewater Utility Questionnaire

Countywide Potable Reuse Evaluation

County of Santa Barbara | 130 E Victoria Street, Suite 200, Santa Barbara, CA 93101

Phone: (805) 568-3440

Please complete this form to the best of your ability and return via email to Matt Young (mcyoung@countyofsb.org) by Friday, March 3rd 2023.

General Information

Utility Name:	Mission Hills CSD
Wastewater Treatment Plant Name:	Mission Hills WWTP
Wastewater Treatment Plant Address:	1550 East Burton Mesa Blvd

Existing Wastewater System

Wastewater Treatment:

Nutrient Removal:	<input type="checkbox"/> Nitrification <input checked="" type="checkbox"/> Nit/Denit <input type="checkbox"/> No Nutrient Removal
Tertiary Filtration:	<input type="checkbox"/> Media or Cloth Filtration <input type="checkbox"/> Membrane Filtration <input type="checkbox"/> No Filtration
Disinfection:	<input type="checkbox"/> Chlorination <input type="checkbox"/> UV <input checked="" type="checkbox"/> No Disinfection

Effluent Flow:

Average Dry Weather Flow (MGD):	190,000 gpd
Is flow equalized?	<input type="checkbox"/> Yes <input checked="" type="checkbox"/> No
Effluent Discharge Location:	<input type="checkbox"/> Surface Water Discharge <input type="checkbox"/> Ocean Outfall <input checked="" type="checkbox"/> Land Application
Does your facility discharge to a location with a minimum flow requirement? <i>If yes, note body of water and flow requirement.</i>	<input type="checkbox"/> Yes <input checked="" type="checkbox"/> No [NOTE FLOW REQUIREMENTS HERE, IF APPLICABLE]



Wastewater Utility Questionnaire

Countywide Potable Reuse Evaluation

County of Santa Barbara | 130 E Victoria Street, Suite 200, Santa Barbara, CA 93101

Phone: (805) 568-3440

Water Reuse

<p>Does your utility have a water reuse program implemented currently?</p>	<input type="checkbox"/> Yes <input checked="" type="checkbox"/> No <input type="checkbox"/> Not currently implemented, but planned for... [INPUT DATE HERE]
<p>Average recycled water flow (MGD or gpd): <i>If project is planned, please note anticipated flow.</i></p>	[INPUT VALUE HERE]
<p>Is the recycled water flow equalized and constant or a variable flow? <i>If project is planned, please note anticipated flow type.</i></p>	<input type="checkbox"/> Equalized and constant <input type="checkbox"/> Variable <input checked="" type="checkbox"/> N/A, no program in place
<p>What is the current end use of the recycled water? <i>If project is planned, please note anticipated end use.</i></p>	<input type="checkbox"/> Potable Water Reuse <input type="checkbox"/> Title 22, Irrigation Application <input type="checkbox"/> Title 22, Industry Application <input type="checkbox"/> Non-Title 22 Application <input checked="" type="checkbox"/> N/A, no program in place
<p>If no program currently implemented or planned, does your utility have interest in implementing a water reuse program?</p>	<input type="checkbox"/> Yes <input type="checkbox"/> No <input type="checkbox"/> Need more information to decide, such as... [INPUT REASONS HERE]

Drinking Water Supply

<p>When do you anticipate a water supply deficit in your community?</p>	<input checked="" type="checkbox"/> No foreseeable deficit <input type="checkbox"/> Experiencing a deficit now <input type="checkbox"/> Within 5-years <input type="checkbox"/> Within 10-years <input type="checkbox"/> 15 or more years
---	---



Wastewater Utility Questionnaire

Countywide Potable Reuse Evaluation

County of Santa Barbara | 130 E Victoria Street, Suite 200, Santa Barbara, CA 93101

Phone: (805) 568-3440

Please complete this form to the best of your ability and return via email to Matt Young (mcyoung@countyofsb.org) by Friday, March 3rd 2023.

General Information

Utility Name:	Montecito Sanitary District
Wastewater Treatment Plant Name:	Wastewater Treatment Plant
Wastewater Treatment Plant Address:	1042 Monte Cristo Ln, Montecito, CA 93108

Existing Wastewater System

Wastewater Treatment:

Nutrient Removal:	<input checked="" type="checkbox"/> Nitrification <input type="checkbox"/> Nit/Denit <input type="checkbox"/> No Nutrient Removal
Tertiary Filtration:	<input type="checkbox"/> Media or Cloth Filtration <input type="checkbox"/> Membrane Filtration <input checked="" type="checkbox"/> No Filtration
Disinfection:	<input checked="" type="checkbox"/> Chlorination <input type="checkbox"/> UV <input type="checkbox"/> No Disinfection

Effluent Flow:

Average Dry Weather Flow (MGD):	0.7 mgd
Is flow equalized?	<input type="checkbox"/> Yes <input checked="" type="checkbox"/> No
Effluent Discharge Location:	<input type="checkbox"/> Surface Water Discharge <input checked="" type="checkbox"/> Ocean Outfall <input type="checkbox"/> Land Application
Does your facility discharge to a location with a minimum flow requirement? <i>If yes, note body of water and flow requirement.</i>	<input type="checkbox"/> Yes <input checked="" type="checkbox"/> No [NOTE FLOW REQUIREMENTS HERE, IF APPLICABLE]



Wastewater Utility Questionnaire

Countywide Potable Reuse Evaluation

County of Santa Barbara | 130 E Victoria Street, Suite 200, Santa Barbara, CA 93101

Phone: (805) 568-3440

Water Reuse

<p>Does your utility have a water reuse program implemented currently?</p>	<p><input type="checkbox"/> Yes</p> <p><input type="checkbox"/> No</p> <p><input checked="" type="checkbox"/> Not currently implemented, but planned for...</p> <p>Pursuing a variety of reuse options (NPR, IPR, DPR). Most promising is IPR with Carpinteria SD.</p>
<p>Average recycled water flow (MGD or gpd):</p> <p><i>If project is planned, please note anticipated flow.</i></p>	<p>[INPUT VALUE HERE]</p>
<p>Is the recycled water flow equalized and constant or a variable flow?</p> <p><i>If project is planned, please note anticipated flow type.</i></p>	<p><input type="checkbox"/> Equalized and constant</p> <p><input type="checkbox"/> Variable</p> <p><input checked="" type="checkbox"/> N/A, no program in place</p>
<p>What is the current end use of the recycled water?</p> <p><i>If project is planned, please note anticipated end use.</i></p>	<p><input type="checkbox"/> Potable Water Reuse</p> <p><input type="checkbox"/> Title 22, Irrigation Application</p> <p><input type="checkbox"/> Title 22, Industry Application</p> <p><input type="checkbox"/> Non-Title 22 Application</p> <p><input checked="" type="checkbox"/> N/A, no program in place</p>
<p>If no program currently implemented or planned, does your utility have interest in implementing a water reuse program?</p>	<p><input checked="" type="checkbox"/> Yes</p> <p><input type="checkbox"/> No</p> <p><input type="checkbox"/> Need more information to decide, such as...</p> <p>[INPUT REASONS HERE]</p>

Drinking Water Supply

<p>When do you anticipate a water supply deficit in your community?</p>	<p><input type="checkbox"/> No foreseeable deficit</p> <p><input type="checkbox"/> Experiencing a deficit now</p> <p><input type="checkbox"/> Within 5-years</p> <p><input type="checkbox"/> Within 10-years</p> <p><input type="checkbox"/> 15 or more years</p>
---	---



Wastewater Utility Questionnaire

Countywide Potable Reuse Evaluation

County of Santa Barbara | 130 E Victoria Street, Suite 200, Santa Barbara, CA 93101

Phone: (805) 568-3440

Please complete this form to the best of your ability and return via email to Matt Young (mcyoung@countyofsb.org) by Friday, March 3rd 2023.

General Information

Utility Name:	City of Santa Barbara
Wastewater Treatment Plant Name:	El Estero Water Resource Center
Wastewater Treatment Plant Address:	520 E Yanonali St, Santa Barbara, CA 93103

Existing Wastewater System

Wastewater Treatment:

Nutrient Removal:	<input type="checkbox"/> Nitrification <input checked="" type="checkbox"/> Nit/Denit <input type="checkbox"/> No Nutrient Removal
Tertiary Filtration:	<input checked="" type="checkbox"/> Media or Cloth Filtration <input type="checkbox"/> Membrane Filtration <input type="checkbox"/> No Filtration
Disinfection:	<input checked="" type="checkbox"/> Chlorination <input type="checkbox"/> UV <input type="checkbox"/> No Disinfection

Effluent Flow:

Average Dry Weather Flow (MGD):	7.0 mgd
Is flow equalized?	<input type="checkbox"/> Yes <input checked="" type="checkbox"/> No
Effluent Discharge Location:	<input type="checkbox"/> Surface Water Discharge <input checked="" type="checkbox"/> Ocean Outfall <input type="checkbox"/> Land Application
Does your facility discharge to a location with a minimum flow requirement? <i>If yes, note body of water and flow requirement.</i>	<input type="checkbox"/> Yes <input checked="" type="checkbox"/> No [NOTE FLOW REQUIREMENTS HERE, IF APPLICABLE]



Wastewater Utility Questionnaire

Countywide Potable Reuse Evaluation

County of Santa Barbara | 130 E Victoria Street, Suite 200, Santa Barbara, CA 93101

Phone: (805) 568-3440

Water Reuse

<p>Does your utility have a water reuse program implemented currently?</p>	<p><input checked="" type="checkbox"/> Yes</p> <p><input type="checkbox"/> No</p> <p><input type="checkbox"/> Not currently implemented, but planned for...</p> <p>[INPUT DATE HERE]</p>
<p>Average recycled water flow (MGD or gpd):</p> <p><i>If project is planned, please note anticipated flow.</i></p>	<p>0.6 mgd</p>
<p>Is the recycled water flow equalized and constant or a variable flow?</p> <p><i>If project is planned, please note anticipated flow type.</i></p>	<p><input checked="" type="checkbox"/> Equalized and constant</p> <p><input type="checkbox"/> Variable</p> <p><input type="checkbox"/> N/A, no program in place</p>
<p>What is the current end use of the recycled water?</p> <p><i>If project is planned, please note anticipated end use.</i></p>	<p><input type="checkbox"/> Potable Water Reuse</p> <p><input checked="" type="checkbox"/> Title 22, Irrigation Application</p> <p><input type="checkbox"/> Title 22, Industry Application</p> <p><input type="checkbox"/> Non-Title 22 Application</p> <p><input type="checkbox"/> N/A, no program in place</p>
<p>If no program currently implemented or planned, does your utility have interest in implementing a water reuse program?</p>	<p><input checked="" type="checkbox"/> Yes</p> <p><input type="checkbox"/> No</p> <p><input type="checkbox"/> Need more information to decide, such as...</p> <p><i>Currently evaluating potable reuse potentially with Montecito (MSD).</i></p>

Drinking Water Supply

<p>When do you anticipate a water supply deficit in your community?</p>	<p><input type="checkbox"/> No foreseeable deficit</p> <p><input type="checkbox"/> Experiencing a deficit now</p> <p><input type="checkbox"/> Within 5-years</p> <p><input type="checkbox"/> Within 10-years</p> <p><input type="checkbox"/> 15 or more years</p>
---	---



Wastewater Utility Questionnaire

Countywide Potable Reuse Evaluation

County of Santa Barbara | 130 E Victoria Street, Suite 200, Santa Barbara, CA 93101

Phone: (805) 568-3440

Please complete this form to the best of your ability and return via email to Matt Young (mcyoung@countyofsb.org) by Friday, March 3rd 2023.

General Information

Utility Name:	City of Santa Maria
Wastewater Treatment Plant Name:	City of Santa Maria Wastewater Treatment Plant
Wastewater Treatment Plant Address:	601 Black Road, Santa Maria, CA 93458

Existing Wastewater System

Wastewater Treatment:

Nutrient Removal:	<input type="checkbox"/> Nitrification <input type="checkbox"/> Nit/Denit <input checked="" type="checkbox"/> No Nutrient Removal
Tertiary Filtration:	<input type="checkbox"/> Media or Cloth Filtration <input type="checkbox"/> Membrane Filtration <input checked="" type="checkbox"/> No Filtration
Disinfection:	<input type="checkbox"/> Chlorination <input type="checkbox"/> UV <input checked="" type="checkbox"/> No Disinfection

Effluent Flow:

Average Dry Weather Flow (MGD):	7.3 MGD
Is flow equalized?	<input type="checkbox"/> Yes <input checked="" type="checkbox"/> No
Effluent Discharge Location:	<input type="checkbox"/> Surface Water Discharge <input type="checkbox"/> Ocean Outfall <input type="checkbox"/> Land Application <input checked="" type="checkbox"/> Percolation Ponds
Does your facility discharge to a location with a minimum flow requirement? <i>If yes, note body of water and flow requirement.</i>	<input type="checkbox"/> Yes <input checked="" type="checkbox"/> No [NOTE FLOW REQUIREMENTS HERE, IF APPLICABLE]



Wastewater Utility Questionnaire

Countywide Potable Reuse Evaluation

County of Santa Barbara | 130 E Victoria Street, Suite 200, Santa Barbara, CA 93101

Phone: (805) 568-3440

Water Reuse

<p>Does your utility have a water reuse program implemented currently?</p>	<p><input type="checkbox"/> Yes <input checked="" type="checkbox"/> No <input type="checkbox"/> Not currently implemented, but planned for...</p>
<p>Average recycled water flow (MGD or gpd): <i>If project is planned, please note anticipated flow.</i></p>	<p>NA</p>
<p>Is the recycled water flow equalized and constant or a variable flow? <i>If project is planned, please note anticipated flow type.</i></p>	<p><input type="checkbox"/> Equalized and constant <input type="checkbox"/> Variable <input checked="" type="checkbox"/> N/A, no program in place</p>
<p>What is the current end use of the recycled water? <i>If project is planned, please note anticipated end use.</i></p>	<p><input type="checkbox"/> Potable Water Reuse <input type="checkbox"/> Title 22, Irrigation Application <input type="checkbox"/> Title 22, Industry Application <input type="checkbox"/> Non-Title 22 Application <input checked="" type="checkbox"/> N/A, no program in place</p>
<p>If no program currently implemented or planned, does your utility have interest in implementing a water reuse program?</p>	<p><input type="checkbox"/> Yes <input checked="" type="checkbox"/> No <input type="checkbox"/> Need more information to decide, such as...</p> <p>Note: Effluent is percolated into the same groundwater basin that is used as the City's groundwater supply, essentially, the effluent is reused.</p>

Drinking Water Supply

<p>When do you anticipate a water supply deficit in your community?</p>	<p><input checked="" type="checkbox"/> No foreseeable deficit <input type="checkbox"/> Experiencing a deficit now <input type="checkbox"/> Within 5-years <input type="checkbox"/> Within 10-years <input type="checkbox"/> 15 or more years</p>
---	--



Wastewater Utility Questionnaire

Countywide Potable Reuse Evaluation

County of Santa Barbara | 130 E Victoria Street, Suite 200, Santa Barbara, CA 93101

Phone: (805) 568-3440

Please complete this form to the best of your ability and return via email to Matt Young (mcyoung@countyofsb.org) by Friday, March 3rd 2023.

General Information

Utility Name:	Santa Ynez Band of Chumash Indians
Wastewater Treatment Plant Name:	Chumash Casino Resort WWTP
Wastewater Treatment Plant Address:	3400 246 E. Highway 246, Santa Ynez, Ca. 93460

Existing Wastewater System

Wastewater Treatment:

Nutrient Removal:	<input type="checkbox"/> Nitrification <input checked="" type="checkbox"/> Nit/Denit <input type="checkbox"/> No Nutrient Removal
Tertiary Filtration:	<input type="checkbox"/> Media or Cloth Filtration <input checked="" type="checkbox"/> Membrane Filtration <input type="checkbox"/> No Filtration
Disinfection:	<input checked="" type="checkbox"/> Chlorination <input type="checkbox"/> UV <input type="checkbox"/> No Disinfection

Effluent Flow:

Average Dry Weather Flow (MGD):	0.098
Is flow equalized?	<input type="checkbox"/> Yes <input checked="" type="checkbox"/> No
Effluent Discharge Location:	<input checked="" type="checkbox"/> Surface Water Discharge <input type="checkbox"/> Ocean Outfall <input checked="" type="checkbox"/> Land Application
Does your facility discharge to a location with a minimum flow requirement? <i>If yes, note body of water and flow requirement.</i>	<input type="checkbox"/> Yes <input checked="" type="checkbox"/> No [NOTE FLOW REQUIREMENTS HERE, IF APPLICABLE]



Wastewater Utility Questionnaire

Countywide Potable Reuse Evaluation

County of Santa Barbara | 130 E Victoria Street, Suite 200, Santa Barbara, CA 93101

Phone: (805) 568-3440

Water Reuse

<p>Does your utility have a water reuse program implemented currently?</p>	<input checked="" type="checkbox"/> Yes <input type="checkbox"/> No <input type="checkbox"/> Not currently implemented, but planned for... [INPUT DATE HERE]
<p>Average recycled water flow (MGD or gpd): <i>If project is planned, please note anticipated flow.</i></p>	<p>0.085</p>
<p>Is the recycled water flow equalized and constant or a variable flow? <i>If project is planned, please note anticipated flow type.</i></p>	<input type="checkbox"/> Equalized and constant <input checked="" type="checkbox"/> Variable <input type="checkbox"/> N/A, no program in place
<p>What is the current end use of the recycled water? <i>If project is planned, please note anticipated end use.</i></p>	<input type="checkbox"/> Potable Water Reuse <input checked="" type="checkbox"/> Title 22, Irrigation Application <input checked="" type="checkbox"/> Title 22, Industry Application <input type="checkbox"/> Non-Title 22 Application <input type="checkbox"/> N/A, no program in place
<p>If no program currently implemented or planned, does your utility have interest in implementing a water reuse program?</p>	<input type="checkbox"/> Yes <input type="checkbox"/> No <input type="checkbox"/> Need more information to decide, such as... [INPUT REASONS HERE]

Drinking Water Supply

<p>When do you anticipate a water supply deficit in your community?</p>	<input checked="" type="checkbox"/> No foreseeable deficit <input type="checkbox"/> Experiencing a deficit now <input type="checkbox"/> Within 5-years <input type="checkbox"/> Within 10-years <input type="checkbox"/> 15 or more years
---	---



Wastewater Utility Questionnaire

Countywide Potable Reuse Evaluation

County of Santa Barbara | 130 E Victoria Street, Suite 200, Santa Barbara, CA 93101

Phone: (805) 568-3440

Please complete this form to the best of your ability and return via email to Matt Young (mcyoung@countyofsb.org) by Friday, March 3rd 2023.

General Information

Utility Name:	CITY OF SOLVANG
Wastewater Treatment Plant Name:	COS WWTP
Wastewater Treatment Plant Address:	1644 Oak Street Solvang, CA 93463

Existing Wastewater System

Wastewater Treatment:

Nutrient Removal:	<input checked="" type="checkbox"/> Nitrification <input type="checkbox"/> Nit/Denit <input type="checkbox"/> No Nutrient Removal
Tertiary Filtration:	<input type="checkbox"/> Media or Cloth Filtration <input type="checkbox"/> Membrane Filtration <input checked="" type="checkbox"/> No Filtration
Disinfection:	<input type="checkbox"/> Chlorination <input type="checkbox"/> UV <input checked="" type="checkbox"/> No Disinfection

Effluent Flow:

Average Dry Weather Flow (MGD):	0.7
Is flow equalized?	<input type="checkbox"/> Yes <input checked="" type="checkbox"/> No
Effluent Discharge Location:	<input type="checkbox"/> Surface Water Discharge <input type="checkbox"/> Ocean Outfall <input type="checkbox"/> Land Application <input checked="" type="checkbox"/> Percolation Ponds
Does your facility discharge to a location with a minimum flow requirement? <i>If yes, note body of water and flow requirement.</i>	<input type="checkbox"/> Yes <input checked="" type="checkbox"/> No [NOTE FLOW REQUIREMENTS HERE, IF APPLICABLE]



Wastewater Utility Questionnaire

Countywide Potable Reuse Evaluation

County of Santa Barbara | 130 E Victoria Street, Suite 200, Santa Barbara, CA 93101

Phone: (805) 568-3440

Water Reuse

<p>Does your utility have a water reuse program implemented currently?</p>	<p><input type="checkbox"/> Yes</p> <p><input checked="" type="checkbox"/> No</p> <p><input type="checkbox"/> Not currently implemented, but planned for...</p> <p>[INPUT DATE HERE]</p>
<p>Average recycled water flow (MGD or gpd):</p> <p><i>If project is planned, please note anticipated flow.</i></p>	<p>[INPUT VALUE HERE]</p>
<p>Is the recycled water flow equalized and constant or a variable flow?</p> <p><i>If project is planned, please note anticipated flow type.</i></p>	<p><input type="checkbox"/> Equalized and constant</p> <p><input type="checkbox"/> Variable</p> <p><input checked="" type="checkbox"/> N/A, no program in place</p>
<p>What is the current end use of the recycled water?</p> <p><i>If project is planned, please note anticipated end use.</i></p>	<p><input type="checkbox"/> Potable Water Reuse</p> <p><input type="checkbox"/> Title 22, Irrigation Application</p> <p><input type="checkbox"/> Title 22, Industry Application</p> <p><input type="checkbox"/> Non-Title 22 Application</p> <p><input checked="" type="checkbox"/> N/A, no program in place</p>
<p>If no program currently implemented or planned, does your utility have interest in implementing a water reuse program?</p>	<p><input checked="" type="checkbox"/> Yes</p> <p><input type="checkbox"/> No</p> <p><input type="checkbox"/> Need more information to decide, such as...</p> <p>[INPUT REASONS HERE]</p>

Drinking Water Supply

<p>When do you anticipate a water supply deficit in your community?</p>	<p><input type="checkbox"/> No foreseeable deficit</p> <p><input type="checkbox"/> Experiencing a deficit now</p> <p><input type="checkbox"/> Within 5-years</p> <p><input type="checkbox"/> Within 10-years</p> <p><input type="checkbox"/> 15 or more years</p>
---	---



Wastewater Utility Questionnaire

Countywide Potable Reuse Evaluation

County of Santa Barbara | 130 E Victoria Street, Suite 200, Santa Barbara, CA 93101

Phone: (805) 568-3440

Please complete this form to the best of your ability and return via email to Matt Young (mcyoung@countyofsb.org) by Friday, March 3rd 2023.

General Information

Utility Name:	Summerland Sanitary District
Wastewater Treatment Plant Name:	Summerland WWTP
Wastewater Treatment Plant Address:	2435 Wallace Ave. Summerland, CA. 93067

Existing Wastewater System

Wastewater Treatment:

Nutrient Removal:	<input type="checkbox"/> Nitrification <input checked="" type="checkbox"/> Nit/Denit <input type="checkbox"/> No Nutrient Removal
Tertiary Filtration:	<input checked="" type="checkbox"/> Media or Cloth Filtration <input type="checkbox"/> Membrane Filtration <input type="checkbox"/> No Filtration
Disinfection:	<input checked="" type="checkbox"/> Chlorination <input type="checkbox"/> UV <input type="checkbox"/> No Disinfection

Effluent Flow:

Average Dry Weather Flow (MGD):	[INPUT VALUE HERE]
Is flow equalized?	<input checked="" type="checkbox"/> Yes <input type="checkbox"/> No
Effluent Discharge Location:	<input type="checkbox"/> Surface Water Discharge <input checked="" type="checkbox"/> Ocean Outfall <input type="checkbox"/> Land Application
Does your facility discharge to a location with a minimum flow requirement? <i>If yes, note body of water and flow requirement.</i>	<input type="checkbox"/> Yes <input checked="" type="checkbox"/> No [NOTE FLOW REQUIREMENTS HERE, IF APPLICABLE]



Wastewater Utility Questionnaire

Countywide Potable Reuse Evaluation

County of Santa Barbara | 130 E Victoria Street, Suite 200, Santa Barbara, CA 93101

Phone: (805) 568-3440

Water Reuse

<p>Does your utility have a water reuse program implemented currently?</p>	<input type="checkbox"/> Yes <input checked="" type="checkbox"/> No <input type="checkbox"/> Not currently implemented, but planned for... [INPUT DATE HERE]
<p>Average recycled water flow (MGD or gpd): <i>If project is planned, please note anticipated flow.</i></p>	[INPUT VALUE HERE]
<p>Is the recycled water flow equalized and constant or a variable flow? <i>If project is planned, please note anticipated flow type.</i></p>	<input type="checkbox"/> Equalized and constant <input type="checkbox"/> Variable <input checked="" type="checkbox"/> N/A, no program in place
<p>What is the current end use of the recycled water? <i>If project is planned, please note anticipated end use.</i></p>	<input type="checkbox"/> Potable Water Reuse <input type="checkbox"/> Title 22, Irrigation Application <input type="checkbox"/> Title 22, Industry Application <input type="checkbox"/> Non-Title 22 Application <input checked="" type="checkbox"/> N/A, no program in place
<p>If no program currently implemented or planned, does your utility have interest in implementing a water reuse program?</p>	<input type="checkbox"/> Yes <input type="checkbox"/> No <input checked="" type="checkbox"/> Need more information to decide, such as... [INPUT REASONS HERE]

Drinking Water Supply

<p>When do you anticipate a water supply deficit in your community?</p>	<input type="checkbox"/> No foreseeable deficit <input type="checkbox"/> Experiencing a deficit now <input type="checkbox"/> Within 5-years <input checked="" type="checkbox"/> Within 10-years <input type="checkbox"/> 15 or more years
---	---

APPENDIX B

MONITORING REQUIREMENTS

APPENDIX B MONITORING REQUIREMENTS

The expected water quality monitoring parameters for direct potable reuse (DPR) feedwater and product water are defined below.

Tables B.1 through B.6 constitute the anticipated water quality performance for an indirect potable reuse project, consistent with Title 22 California Code of Regulations (2019).¹ Within each table is a specific reference to the section or table within the regulation. Table B.7 indicates the monitoring requirements for contaminants of emerging concern (CECs) per the State Water Resources Control Board (SWRCB) *Water Quality Control Plan for Recycled Water*.² It is anticipated that these will be the majority of constituents that require monthly monitoring for a DPR project. There may be additional parameters added upon regulation finalization.

Table B.1 Inorganics With Primary Maximum Contaminant Levels or Action Levels⁽¹⁾

Constituents	Primary MCL or AL (in mg/L)	Constituents	Primary MCL or AL (in mg/L)
Aluminum	1.0	Fluoride	2
Antimony	0.006	Lead	0.015 ⁽³⁾⁽⁴⁾
Arsenic	0.010	Mercury	0.002
Asbestos	7 (MFL) ⁽²⁾	Nickel	0.1
Barium	1	Nitrate (as N)	10
Beryllium	0.004	Nitrite (as N)	1
Cadmium	0.005	Total Nitrate/Nitrite (as N)	10
Chromium	0.05	Perchlorate	0.006
Copper	1.3 ⁽³⁾	Selenium	0.05
Cyanide	0.15	Thallium	0.002

Notes:

(1) Based on Table 64431-A and Section 64678.

(2) MFL with fiber lengths >10 microns.

(3) Regulatory AL; if system exceeds, it must take certain actions such as additional monitoring, corrosion control studies, and treatment, and for lead, a public education program; replaces MCL.

(4) The MCL for lead was rescinded with the adoption of the regulatory AL described in note 3.

AL - action level; MCL - maximum contaminant level; MFL - million fibers per liter; mg/L - milligrams per liter; N - nitrogen

¹ SWRCB (2018). Regulations Related to Recycled Water. Effective October 1, 2018.

https://www.waterboards.ca.gov/drinking_water/certlic/drinkingwater/documents/lawbook/RWregulations_20181001.pdf.

² SWRCB (2019). Water Quality Control Policy for Recycled Water. Adopted December 11, 2018. Effective April 8, 2019.

https://www.waterboards.ca.gov/board_decisions/adopted_orders/resolutions/2018/121118_7_final_amendment_oal.pdf.

Table B.2 Radioactivity⁽¹⁾

Constituents	MCL (in pCi/L)	Constituents	MCL (in pCi/L)
Uranium	20	Beta/Photon Emitters	50 ⁽²⁾
Combined Radium-226 & 228	5	Strontium-90	8 ⁽²⁾
Gross Alpha Particle Activity	15	Tritium	20,000 ⁽²⁾

Notes:

(1) Based on Tables 64442 and 64443.

(2) MCLs are intended to ensure that exposure above 4 millirem per year does not occur.
pCi/L - picocuries per liter

Table B.3 Regulated Organics⁽¹⁾

Constituents	MCL (in mg/L)	Constituents	MCL (in mg/L)
Volatile Organic Compounds			
Benzene	0.001	Monochlorobenzene	0.07
Carbon Tetrachloride	0.0005	Styrene	0.1
1,2-Dichlorobenzene	0.6	1,1,2,2-Tetrachloroethane	0.001
1,4-Dichlorobenzene	0.005	Tetrachloroethylene	0.005
1,1-Dichloroethane	0.005	Toluene	0.15
1,2-Dichloroethane	0.0005	1,2,4 Trichlorobenzene	0.005
1,1-Dichloroethylene	0.006	1,1,1-Trichloroethane	0.2
cis-1,2-Dichloroethylene	0.006	1,1,2-Trichloroethane	0.005
trans-1,2-Dichloroethylene	0.01	Trichloroethylene	0.005
Dichloromethane	0.005	Trichlorofluoromethane	0.15
1,3-Dichloropropene	0.0005	1,1,2-Trichloro-1,2,2-Trifluoroethane	1.2
1,2-Dichloropropane	0.005	Vinyl Chloride	0.0005
Ethylbenzene	0.3	Xylenes	1.75
MTBE	0.013		
Synthetic Organic Compounds			
Alachlor	0.002	Heptachlor	0.00001
Atrazine	0.001	Heptachlor Epoxide	0.00001
Bentazon	0.018	Hexachlorobenzene	0.001
Benzo(a) Pyrene	0.0002	Hexachlorocyclopentadiene	0.05
Carbofuran	0.018	Lindane	0.0002
Chlordane	0.0001	Methoxychlor	0.03
Dalapon	0.2	Molinate	0.02
Dibromochloropropane	0.0002	Oxamyl	0.05
Di(2-ethylhexyl)adipate	0.4	Pentachlorophenol	0.001
Di(2-ethylhexyl)phthalate	0.004	Picloram	0.5
2,4-D	0.07	Polychlorinated Biphenyls	0.0005

Constituents	MCL (in mg/L)	Constituents	MCL (in mg/L)
Dinoseb	0.007	Simazine	0.004
Diquat	0.02	Thiobencarb	0.07/0.001 ⁽²⁾
Endothall	0.1	Toxaphene	0.003
Endrin	0.002	1,2,3-Trichloropropane	5x10-6
Ethylene Dibromide	0.00005	2,3,7,8-TCDD (Dioxin)	3x10-8
Glyphosate	0.7	2,4,5-TP (Silvex)	0.05

Notes:

(1) Based on Table 64444-A.

(2) Second value is listed as a secondary MCL.

MTBE - methyl tertiary-butyl ether

Table B.4 Disinfection Byproducts⁽¹⁾

Constituents	MCL (in mg/L)	Constituents	MCL (in mg/L)
Total Trihalomethanes	0.080	Bromate	0.010
Total Haloacetic Acids	0.060	Chlorite	1.0

Notes:

(1) Based on Table 64533-A.

Table B.5 Constituents/Parameters With Secondary MCLs

Constituents ⁽¹⁾	MCL (in mg/L)	Constituents ⁽²⁾	MCL (in mg/L)
Aluminum	0.2	TDS	500
Color	15 (units)	Specific Conductance	900 µS/cm
Copper	1	Chloride	250
Foaming Agents (MBAS)	0.5	Sulfate	250
Iron	0.3		
Manganese	0.05		
MTBE	0.005		
Odor Threshold	3 (units)		
Silver	0.1		
Thiobencarb	0.001		
Turbidity	5 (NTU)		
Zinc	5		

Notes:

(1) Based on Table 64449-A.

(2) Based on Table 64449-B.

MBAS - methylene blue active substances; NTU - nephelometric turbidity unit; TDS - total dissolved solids; µS/cm - microsiemens per centimeter

Table B.6 Constituents With Notification Levels^(1, 2)

Constituents	NL (in µg/L)	Constituents ⁽³⁾	NL (in µg/L)
Boron ⁽⁴⁾	1,000	MIBK	120
n-Butylbenzene	260	Naphthalene	17
sec-Butylbenzene	260	NDEA	0.01
tert-Butylbenzene	260	NDMA	0.01
Carbon disulfide	160	NDPA	0.01
Chlorate	800	PFBS	0.5
2-Chlorotoluene	140	PFOA	0.0051
4-Chlorotoluene	140	PFOS	0.0065
Diazinon	1.2	Propachlor	90
Dichlorodifluoromethane (Freon 12)	1,000	n-Propylbenzene	260
1,4-Dioxane	1	RDX ⁽³⁾	0.3
Ethylene glycol	14,000	TBA	12
Formaldehyde	100	1,2,4-Trimethylbenzene	330
HMX	350	1,3,5-Trimethylbenzene	330
Isopropylbenzene	770	TNT	1
Manganese	500 ⁽²⁾	Vanadium	50

Notes:

- (1) Based on https://www.waterboards.ca.gov/drinking_water/certlic/drinkingwater/documents/notificationlevels/notification_response_level_overview_2022_02_09.pdf, published February 9, 2022.
 - (2) The web link above also contains the levels of the pollutants in this table that must result in a removal of the water source from service.
 - (3) RDX - research department explosive (O₂NNCH₂)₃.
 - (4) Central Coast Basin Plan Water Quality Objective is more stringent: Boron - 750 µg/L (500 µg/L is the “no problem” water quality guideline).
- HMX - high melting explosive; MIBK - methyl isobutyl ketone; NDEA - N-nitrosodiethylamine; NDMA - N-nitrosodimethylamine; NDPA - N-nitrosodi-n-propylamine; NL - notification level; PFBS - perfluorobutanesulfonic acid; PFOA - perfluorooctanoic acid; PFOS - perfluorooctanesulfonic acid; RDX - research department explosive (O₂NNCH₂)₃; TBA - tertiary butyl alcohol; TNT - 2,4,6-trinitrotoluene; µg/L - micrograms per liter

Table B.7 Monitoring Requirements for CECs per SWRCB (2019a)

Constituent	Relevance	MTL (in µg/L)	Example Removal Percentages (%)
1,4-Dioxane	Health	1	--
NDMA ⁽¹⁾	Health and Performance	0.010	>25-50, 80
NMOR ⁽²⁾	Health	0.012	--
PFOS	Health	0.0065	--
PFOA	Health	0.0051	--
Sulfamethoxazole ⁽²⁾	Performance	-	>90
Sucralose ⁽²⁾	Performance	-	>90

Constituent	Relevance	MTL (in µg/L)	Example Removal Percentages (%)
Dissolved Organic Carbon ⁽²⁾	Surrogate (example) ⁽³⁾	-	>90
UV Absorbance ⁽²⁾	Surrogate (example) ⁽³⁾	-	>50
EC ⁽²⁾	Surrogate (example) ⁽³⁾	-	>90
Estrogen receptor-alpha bioassay ⁽²⁾	Bioanalytical Screening	-	--
Aryl hydrocarbon bioassay ⁽²⁾	Bioanalytical Screening	-	--

Notes:

- (1) Health-based CECs and Bioanalytical Screening to be monitored following treatment.
 - (2) Performance indicator CECs to be monitored before reverse osmosis and after treatment.
 - (3) Surrogates are provided as examples. Surrogates should be used to demonstrate effectiveness of individual processes for removing CECs.
- % - percent; EC - electrical conductivity; MTL - monitoring trigger levels; NMOR - N-nitrosomorpholine; UV - ultraviolet

APPENDIX C **DESIGN CRITERIA SUMMARY**

APPENDIX C DESIGN CRITERIA SUMMARY

The design criteria for each unit process are summarized in the tables below.

Table C.1 Ozone Design Criteria for DPR

Process and Criteria	Unit	Buellton	Solvang	Buellton + Solvang
Feed Flow	mgd	0.4	1.00	1.02
Ozone Production				
Ozone Applied Dose	mg/L	20	20	20
Ozone MTE	%	90	90	90
Ozone Transferred Dose	mg/L	18	18	18
Ozone Production	ppd	72	167	170
Ozone wt %	%	10	10	10
Ozone CT	min	6	6	6
Ozone CT ⁽¹⁾	mg-min/L	6.43	6.43	6.43
Oxygen Required	ppd	72	167	170
Side Stream Mixing Pumps				
Duty Pumps	No.	1	1	1
Standby Pumps	No.	1	1	1
Capacity Per Pump	gpm	60	139	142
TDH	ft	100	100	100
Motor Size	hp	5	5	5
Drive		VFD	VFD	VFD

Notes:

(1) Ozone CT required to remove 1 log *Cryptosporidium* at 15 degrees Celsius, according to the equation *Cryptosporidium* log removal value (LRV) = CT*0.0397*(1.09757)^{Temperature} (Environmental Protection Agency 2010). The ability to achieve this CT is dependent on the dose-response curve and must be confirmed through jar testing.

% - percent; CT - contact time; DPR - direct potable reuse; ft - feet; gpm - gallons per minute; hp - horsepower; mg/L - milligrams per liter; mg-min/L - milligram-minutes per liter; mgd - million gallons per day; min - minute(s); MTE - mass transfer efficiency; No. - number; ppd - pounds per day; TDH - total dynamic head; VFD - variable frequency drive; wt - weight

Table C.2 Biologically Enhanced Activated Carbon Design Criteria for DPR

Process and Criteria	Unit	Buellton	Solvang	Buellton + Solvang
Duty Filters	No.	3	4	4
Standby/Backwash Filters	No.	1	1	1
Total No. of Filters	No.	4	5	5
Filter Area, each	sf	50	79	79
Filter Depth	ft	6.0	6.0	6.2
Filter Diameter	ft	8.0	10.0	10.0
Flow Per Filter				
All Filters Operating	gpm	100	174	177
One Filter in Backwash	gpm	149	231	236

Process and Criteria	Unit	Buellton	Solvang	Buellton + Solvang
Hydraulic Loading				
All Filters Operating	gpm/ft	2.0	2.2	2.3
One Filter in Backwash	gpm/ft	3.0	2.9	3.0
EBCT				
All Filters Operating	min	22.7	20.3	20.6
One Filter in Backwash	min	15.1	15.2	15.4
Backwash				
No. of Backwashes Per Filter Per Day	No.	1	1	1
Volume Used Per Backwash	gal	11,410	20,028	20,420
Reverse Flow Duration	min	18.2	20.4	20.8
Air Scour Duration	min	5.0	5.0	5.0
Total Backwash Duration	min	23.2	25.4	25.8
Backwash Pump				
Duty Pumps	No.	2	2	2
Standby Pumps	No.	1	1	1
Capacity Per Pump	gpm	628	982	982
Motor Size	hp	10	15	15
Drive	-	VFD	VFD	VFD
Backwash Blowers				
Duty	No.	1	1	1
Standby	No.	1	1	1
Capacity Per Blower ⁽¹⁾	scfm	251	393	393
Discharge Pressure	psi	12	12	12
Motor Size	hp	25	40	40

Notes:

- (1) Air scour requirement for biologically active carbon filter (BAF) is significantly higher than for microfiltration. The blowers have been upsized such that there is sufficient capacity for the BAF blowers to perform air scour for both microfiltration and BAF on the DPR schemes.

EBCT - empty bed contact time; gal - gallons; gpm/ft - gallons per minute per foot; psi - pounds per square inch; scfm - standard cubic feet per minute; sf - square feet

Table C.3 UF Design Criteria

Process and Criteria	Unit	IPR			DPR		
		Buellton	Solvang	Buellton + Solvang	Buellton	Solvang	Buellton + Solvang
UF Process							
Flow Rate		299	694	708	275	639	652
Type	-	Pressurized, Polymeric Hollow Fiber UF					
Overall Recovery	-	95%	95%	95%	97%	97%	97%
No. of Trains in Service	No.	2	2	2	2	2	2
No. of Redundant Trains	No.	1	1	1	1	1	1
No. of Total Trains	No.	3	3	3	3	3	3
Installed Modules Per Train	No.	20	28	48	10	22	22
Temperature Correction							
Peak Capacity Design Temperature	degrees Celsius	20	20	20	20	20	20
Design Peak Flux (at Design Temperature)	gfd	30.0	30.0	30.0	70.0	70.0	70.0
Flow Criteria							
Average Feed Flow Rate	gpm	299	694	708	275	639	652
Feed Water Loss	%	1.7%	1.7%	1.7%	1.0%	1.0%	1.0%
Gross Filtrate Production	gpm	293	682	696	272	633	645
Filtrate Losses	%	3.3%	3.3%	3.3%	2.0%	2.0%	2.0%
Overall Recovery	%	95.0%	95.0%	95.0%	97.0%	97.0%	97.0%
System Net Filtrate	gpm	284	660	673	267	620	632
Instantaneous Factor	-	1.09	1.09	1.09	1.08	1.09	1.08
Online Factor (1/Instantaneous)	-	91%	91%	91%	92%	91%	92%
Instantaneous Filtrate Production	gpm	321	747	762	293	681	694
Module Criteria							
Membrane Area Per Module	sf	775	775	775	775	775	775
Membrane Area Per Train	sf	15,500	37,200	37,200	7,750	17,050	17,050
Membrane Area Total	sf	46,500	111,600	111,600	23,250	51,150	51,150
Gross Flux Rate	gfd	13.6	13.2	13.5	25.3	26.7	27.2
Instantaneous Flux Rate	gfd	14.9	14.5	14.8	27.2	28.7	29.3
Backwash Criteria							
Type	-	Reverse Flow Followed by Air Scour and Drain					
Backwash Interval Per Train							
Minimum	min	20	20	20	20	20	20
Maximum	min	30	30	30	30	30	30
Target Filtration Interval	min	24	24	24	28	28	28
Filtration Flow	ratio	1.5	1.5	1.5	1.1	1.1	1.1
Backwash Supply Flow Rate	gpm	241	336	572	161	374	382

Process and Criteria	Unit	IPR			DPR		
		Buellton	Solvang	Buellton + Solvang	Buellton	Solvang	Buellton + Solvang
Backwash Duration	sec	30	30	30	30	30	30
Air Scour Flow Rate	scfm	110	154	264	55	121	121
Air Scour Duration	sec	30	30	30	30	30	30
Drain Duration	sec	20	20	20	20	20	20
Forward Flush Flow Rate	gpm	720	1,008	1,728	360	792	792
Forward Flush Duration	sec	30	30	30	30	30	30

Notes:

gfd - gallons per square foot per day; IPR - indirect potable reuse; sec - seconds; UF - ultrafiltration

Table C.4 Reverse Osmosis Design Criteria

Process and Criteria	Unit	IPR			DPR		
		Buellton	Solvang ⁽¹⁾	Buellton + Solvang	Buellton	Solvang ⁽¹⁾	Buellton + Solvang
Design Feed Flow Rate	gpm	284	660	673	267	620	632
Recovery	%	80	80	80	80	80	80
Permeate Flow Rate	gpm	227	528	538	213	496	506
Concentrate Flow Rate	gpm	57	132	135	53	124	126
Feed Flow Rate Per Train	gpm	284	660	673	267	620	632
Permeate Flow Rate Per Train	gpm	227	528	538	213	496	506
Concentrate Flow Per Train	gpm	57	132	135	53	124	126
No. of RO Trains							
In-Service	No.	1	2	1	1	2	1
Reliability	No.	1	1	1	1	1	1
Total	No.	2	3	2	2	3	2
Staging of RO Trains							
<i>First Stage</i>							
Pressure Vessels Per Train	No.	6	8	14	6	8	14
Elements Per Pressure Vessels	No.	7	7	7	7	7	7
<i>Second Stage</i>							
Second Stage	No.	3	4	7	3	4	7
Elements Per Pressure Vessels	No.	7	7	7	7	7	7
No. of Elements							
Per Train	No.	63	147	147	63	147	147
Total (In-Service)	No.	126	294	294	126	294	294

Process and Criteria	Unit	IPR			DPR		
		Buellton	Solvang ⁽¹⁾	Buellton + Solvang	Buellton	Solvang ⁽¹⁾	Buellton + Solvang
Membrane Area							
Per Element	sf	400	400	400	400	400	400
Per Train	sf	25,200	58,800	58,800	25,200	58,800	58,800
Total (In-Service)	sf	25,200	58,800	58,800	25,200	58,800	58,800
Average Flux Rate	gfd	13.0	12.9	13.2	12.2	12.1	12.4

Notes:

(1) Solvang RO sized to be 2 + 1 (as opposed to 1 + 1) to deal with flow variability. Most optimum operation will require periodic manual isolation of a single of the two duty trains to operate as a 6:3 2 stage array. A standard operating procedure could be developed for this purpose.

RO - reverse osmosis

Table C.5 Ultraviolet Advanced Oxidation Process Design Criteria

Process and Criteria	Unit	IPR			DPR		
		Buellton	Solvang	Buellton + Solvang	Buellton	Solvang	Buellton + Solvang
No. of Vessels							
In-Service	No.	1	1	1	1	1	1
Reliability ⁽¹⁾	No.	0	0	0	0	0	0
Total	No.	1	1	1	1	1	1
Feed Flow Rate	mgd	0.33	0.76	0.78	0.31	0.71	0.73
Feed Flow Rate Per Reactor	mgd	0.33	0.76	0.78	0.31	0.71	0.73
Lamp Aging and Fouling Factor	%	80	80	80	80	80	80
Design Inlet UVT	%	96	96	96	96	96	96
Design Outlet UVT	%	98	98	98	98	98	98
Design NDMA LRV ⁽²⁾	LRV	>1.0	>1.0	>1.0	>1.0	>1.0	>1.0
Design 1,4-Dioxane LRV	LRV	>0.5	>0.5	>0.5	>0.5	>0.5	>0.5
Hypochlorite Dose	mg/L	5.0	5.0	5.0	5.0	5.0	5.0

Notes:

(1) To optimize footprint and capital expenditure, a single reactor with redundant lamp banks will be installed such that within one reactor, there is still 1 + 1 redundancy.

(2) Assumed NDMA reduction requirement. Bench scale testing required to confirm NDMA in RO permeate.
NDMA - N-nitrosodimethylamine; UVT - ultraviolet transmittance

Table C.6 Stabilization Design Criteria: Calcite Contactors

Process and Criteria	Unit	IPR			DPR		
		Buellton	Solvang	Buellton + Solvang	Buellton	Solvang	Buellton + Solvang
Flow Rate	gpm	227	528	538	213	496	506
No. of Filters	No.	2	2	2	2	2	2
Filter Diameter	ft	6	8	8	6	8	8
Area Per Filter	sf	28	50	50	28	50	50
Media Depth	ft	3	3	3	3	3	3

Process and Criteria	Unit	IPR			DPR		
		Buellton	Solvang	Buellton + Solvang	Buellton	Solvang	Buellton + Solvang
Flow Per Filter							
All Filters Operating	gpm	64	132	135	64	124	126
One Filter Offline	gpm	64	132	135	64	124	126
Hydraulic Loading							
All Filters Operating	gpm/ft	2.2	2.6	2.7	2.3	2.5	2.5
One Filter Offline	gpm/ft	2.2	2.6	2.7	2.3	2.5	2.5
EBCT							
All Filters Operating	min	10.0	8.5	8.4	9.9	9.1	8.9
One Filter in Backwash	min	10.0	8.5	8.4	9.9	9.1	8.9

Table C.7 Secondary Ultraviolet Design Criteria for DPR

Process and Criteria	Unit	Buellton	Solvang	Buellton + Solvang
No. of Reactors ⁽¹⁾				
In-Service	No.	1	1	1
Reliability	No.	0	0	0
Total	No.	1	1	1
Feed Flow Rate	mgd	0.31	0.71	0.73
Feed Flow Rate Per Reactor	mgd	0.31	0.71	0.73
Lamp Aging Factor	(-)	80	80	80
Design UVT	%	98	98	98

Notes:

(1) To optimize footprint and capital expenditure, a single reactor with redundant lamp banks will be installed such that within one reactor, there is still 1 + 1 redundancy.

Table C.8 Product Water Tank/Chlorine Disinfection Design Criteria

Process and Criteria	Unit	IPR			DPR		
		Buellton	Solvang ⁽³⁾	Buellton + Solvang	Buellton	Solvang ⁽³⁾	Buellton + Solvang
Flow Rate	gpm	227	528	538	213	496	506
Baffling Factor	-	0.1	0.1	0.1	0.1	0.1	0.1
Virus LRV ⁽¹⁾	-	2	2	2	2	2	2
Concentration Times CT Value ⁽¹⁾	mg-min/L	9	9	9	9	9	9
Residual Free Chlorine ⁽²⁾	mg/L	3	3	3	3	3	3

Process and Criteria	Unit	IPR			DPR		
		Buellton	Solvang ⁽³⁾	Buellton + Solvang	Buellton	Solvang ⁽³⁾	Buellton + Solvang
Minimum Tank Volume ⁽²⁾	gal	6,809	15,834	16,151	6,397	14,877	15,174
Tank Diameter	ft	10	14	14	10	14	14
Tank Height	ft	12	18	18	12	18	18

Notes:

- (1) The Australian WaterVal Validation protocol published in 2017 was used to determine the concentration times CT value. Per Table 1 of WaterVal, assuming a pH of ≤ 8.5 , > 15 degrees Celsius, and ≤ 2.0 nephelometric turbidity unit, the concentration times CT required for 2 LRV virus is 9 mg-min/L. Note that there is a lot of flexibility in the use of the Australian WaterVal free chlorine credit document.
- (2) Tank volume is for calculation of CT. This volume does not include operational volume, the volume required for pumping, or the volume required for response time.
- (3) Solvang chlorine contact tank sized for peak flows.

Table C.9 Chemical Storage Design Criteria

Chemical	Purpose
Ammonium Sulfate	UF Feed Monochloramination
Antiscalant	RO Feed
Citric Acid	UF MCs and CIPs
Gypsum	Post-Treatment
Sodium Bisulfite	Ozone Quench, Neutralize Clean
Sodium Hydroxide	UF MC, CIP, and Neutralize Clean
Sodium Hypochlorite	Pretreatment, UF MC, CIP, and Residual Disinfectant, UV/AOP
Sulfuric Acid	RO Feed pH Adjustment, Neutralize Clean

Notes:

AOP - advanced oxidation process; CIP - clean-in-place; MC - maintenance clean; UV - ultraviolet

Table C.10 On-Site Blend Tank for DPR

Process and Criteria	Unit	Buellton	Solvang	Buellton + Solvang
Nominal Capacity	gal	180,000	440,000	450,000
Inner Diameter	ft	32	50	51
Sidewater Depth	ft	27	27	27
Freeboard	ft	3	3	3

APPENDIX D **GROUNDWATER BASIN ANALYSIS**

APPENDIX D GROUNDWATER BASIN ANALYSIS

An analysis of the Santa Ynez River Valley Groundwater Basin (Basin) was performed to determine directional flow and velocity near the cities of Buellton and Solvang. This information is then used to evaluate if the groundwater retention time requirements are met based on targeted pathogen removal and time. A minimum of 2 months' travel time is mandatory before purified recycled water (PRW) reaches a drinking water well. Regarding pathogen removal, for each month retained underground the PRW is credited with 1-log virus reduction. For the purpose of this project, groundwater travel times of 6 months and 1-year were targeted, providing a measure of conservatism. Groundwater flow, velocity, and travel times are discussed below.

Santa Ynez River Valley Groundwater Basin

The Basin is located in coastal central California. For purposes of compliance with the Sustainable Groundwater Management Act (SGMA), the Basin was divided into Western, Central, and Eastern Management Areas (WMA, CMA, and EMA respectively) based on physical and political complexities within the Basin. The City of Buellton is located in the CMA while Solvang is located in the EMA.

The Buellton Aquifer, comprising local alluvium, the Paso Robles Formation, and the Careaga Sand Formation, is the principal aquifer in the CMA which covers the Buellton Upland and the older formations that lie under the Santa Ynez River alluvium near the City of Buellton. Two principal aquifers have been identified in the EMA—the Paso Robles Formation and the Careaga Sand. For the purposes of this study, the analysis is focused on areas near the City of Solvang where only the Careaga Sand occurs west of Alamo Pintado Creek.

The Santa Ynez River is the primary surface water source within the Basin. The Santa Ynez River Alluvium consists of the relatively flat area cut by the historical movements of the Santa Ynez River. Water present within the Santa Ynez River Alluvium is considered surface water subject to the jurisdiction of the State Water Resources Control Board (SWRCB) because the hydraulic continuity of the underflow with the surface flow of the Santa Ynez River is such that diversion from the underflow constitutes diversion from the surface water system. Such underflow constitutes subterranean water flowing in known and definite channels; the SWRCB retains administrative authority over the surface flow and underflow of the Santa Ynez River, including wells that divert the underflow. Therefore, although many water supply wells are completed in the Santa Ynez River Alluvium, the alluvium has been excluded from consideration for injection of PRW.

The Basin is filled with an unconsolidated to weakly consolidated tertiary-aged marine sandstone deposit, referred to as the Careaga Sand and non-marine Pliocene- and Pleistocene-aged sand, gravel, silt, and clay deposits that comprise the Paso Robles Formation. In the EMA, the two members of the Careaga Sand (Cebada and Graciosa members) are combined into a single unit. The water-bearing formations of the Careaga Sand and the Paso Robles Formation together extend to a depth of more than 1,000 feet below ground surface beneath the City of Buellton in the CMA and just north of the City of Solvang in the EMA.

In the EMA, overlying these formations to a depth of as much as 150 feet is the Quaternary-aged Older Alluvium, considered a derivative of the Paso Robles Formation and composed of materials that are very similar to the Paso Robles Formation. Because of this similarity, this Older Alluvium is managed as part of the Paso Robles Formation.

Buellton Aquifer

The Buellton Aquifer consists of the Paso Robles and Careaga Formations. In the eastern part of the CMA (including the City of Buellton), this aquifer underlies the Santa Ynez River Alluvium as shown on Figure D.1.

Figure D.1 is a cross-section of the CMA of the Basin running south to north roughly parallel to Highway 101 through the City of Buellton. The cross-section illustrates the Santa Ynez River Alluvium and other alluvium in the shallow zone beneath the city, underlain by the Paso Robles and Careaga Sand Formations comprising the Buellton Aquifer.

The Paso Robles Formation, is composed of sand, silt, and clay of non-marine origin and overlies the older marine Careaga Formation. The Paso Robles Formation contains a large proportion of fine-grained material and is composed chiefly of discontinuous, lenticular, and poorly sorted alluvial-fan deposits. The lower part of the Paso Robles Formation is finer-grained than the upper part. Wells completed in the Paso Robles Formation yield from 200 to 1,000 gallons per minute (gpm). The permeability of the Paso Robles Formation is approximately 5 feet per day.

The Careaga Formation has two sub-members including the upper Graciosa Member with medium to coarse sand, and the lower Cebada Member with typically finer sand. The Graciosa Member is the main producer of groundwater in the Buellton Aquifer. Permeabilities in the Graciosa Member range from 0.1 to 100 feet per day, with an average permeability of approximately 9.4 feet per day. Hydraulic conductivity of the Cebada Member ranges from 0.1 to 3 feet per day. The specific yield of the Careaga Formation ranges from 10 to 30 percent, and a 10 percent specific yield was utilized in the Buellton Upland Groundwater Management Plan (Santa Ynez River Water Conservation District and City of Buellton, 1995).

From the CMA/EMA boundary to the Buellton Bend, including the area beneath the City of Buellton, the Buellton Aquifer lies underneath the Santa Ynez River Alluvium. Because most wells in the Santa Ynez River Alluvium area are shallow, a precise understanding of the Buellton Aquifer underneath the Santa Ynez River is undetermined.

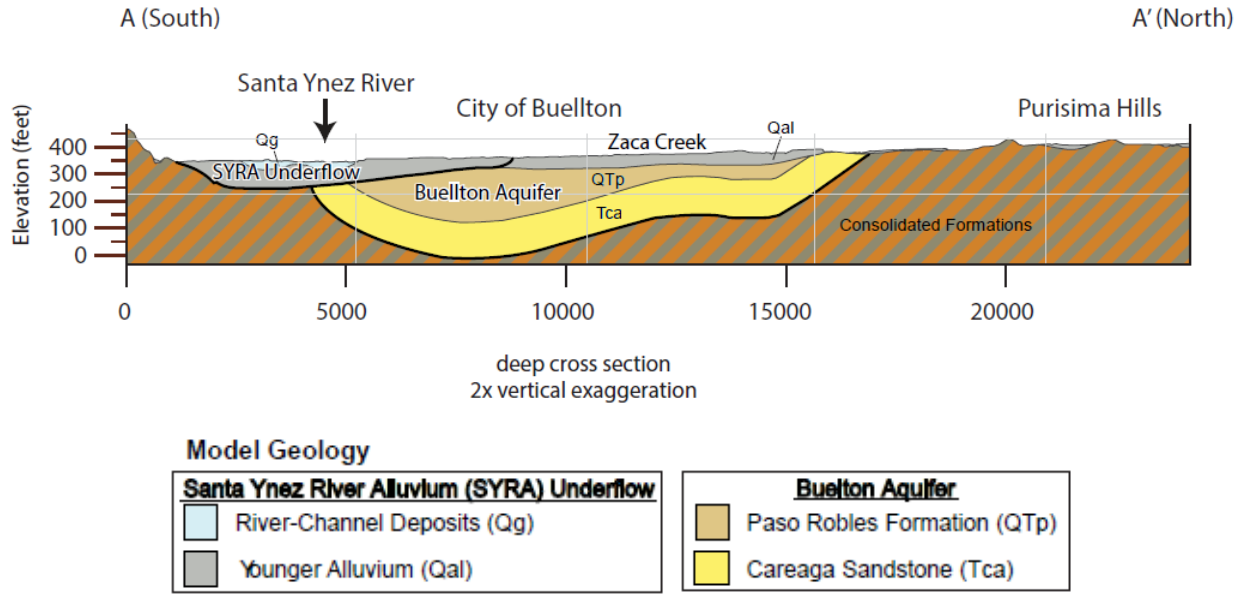

Source: Stetson 2022.

Figure D.1 Central Management Area Geologic Cross Section A - A'

Careaga Sand (Eastern Management Area)

The Careaga Sand is present below the Paso Robles Formation in the Santa Ynez Uplands and below the Santa Ynez River gravels near the City of Solvang. In the Santa Ynez Uplands, the Careaga Sand is approximately 800 feet thick on average and varies between 200 and 900 feet.

Figure D.2 is a cross-section of the southern part of the EMA of the Basin running south to north about 2 miles east of Highway 101, immediately west of the City of Solvang. In this area, the Careaga Sand is near the surface, and the Paso Robles Formation is absent.

The Careaga Sand consists of fine-grained to medium-grained, uniform, massive, marine sand with some gravel and limestone. Two members of the Careaga Sand include the relatively coarse upper Graciosa Member and the relatively fine-grained lower Cebada Member. Driller logs from wells drilled into this unit do not indicate the presence of confining beds that may create barriers to flow in the Careaga Sand.

In the EMA, the Careaga Sand is generally less permeable than the overlying Paso Robles Formation; wells completed in the Careaga Sand typically provide relatively less water than wells in the Paso Robles Formation. The hydraulic conductivity of the Careaga Sand is approximately 10 feet per day, which is similar to the lower end of the range of hydraulic conductivities for the Paso Robles Formation. Pumping test data from a total of six wells completed in the Careaga Sand indicated that hydraulic conductivity ranges between approximately 2 feet and 20 feet per day. Aquifer tests for wells completed in the Careaga Sand ranged between 12 and 325 gpm. Because of the limited lateral extent of the aquifer relative to the Paso Robles Formation within the Santa Ynez Uplands and the greater depth to this formation outside of the western portion of the Santa Ynez Uplands, fewer wells are completed in the Careaga Sand than in the overlying Paso Robles Formation. Wells completed within the Careaga Sand often have sanding problems, especially for wells completed in the lower Cebada Member, because of the uniform fine nature of the material. The specific yield of the Careaga Sand is estimated to be 0.05.

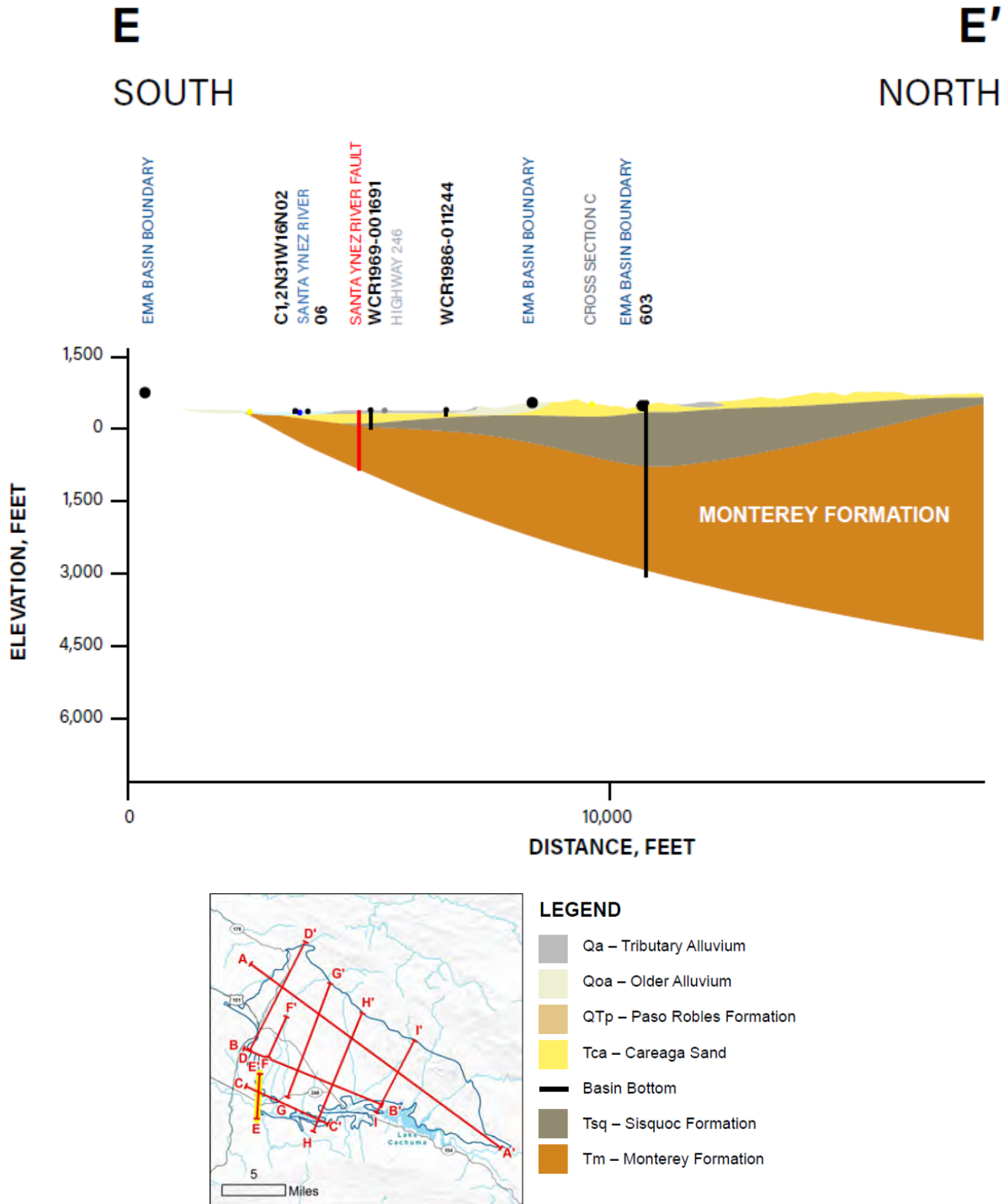

Source: GSI, 2022

Figure D.2 Eastern Management Area Geologic Cross Section E - E'

Groundwater Directional Flow and Velocity

Groundwater flow near the cities of Buellton and Solvang was estimated from available data. As part of annual reporting for SGMA, each Groundwater Sustainability Agency (GSA) must develop groundwater

contour maps for each principal aquifer in the Basin to illustrate groundwater flow under seasonal high and low conditions. The information provided in the GSA Annual Reports provides the most recent and complete data for groundwater levels in the Basin and was therefore used as the basis for estimating groundwater flow conditions for this evaluation. The groundwater velocity was calculated using estimates of hydraulic gradient, hydraulic conductivity, and effective porosity values described below.

Buellton Aquifer

Hydraulic Gradient, $\Delta h/\Delta l$

Groundwater in the Buellton Aquifer generally flows from north to south beneath the upland areas towards the Santa Ynez River. Groundwater elevation monitoring data are limited for the Buellton Aquifer, and the CMA GSA Annual Report does not show groundwater contours for the eastern part of the CMA.

The CMA monitoring network includes two wells near the City of Buellton (6N/32W-12K2 and 6N/31W-7F1). The hydraulic gradient was estimated using reported water levels for these wells for spring and fall 2021, the most recent periods when data was reported for both wells. The hydraulic gradient based on these wells ranges from 0.0011 to 0.0015.

The hydraulic gradient for the area near the City of Buellton was also estimated from the contours shown in the 2022 GSA Annual Report for spring and fall 2022. On these maps, the contours are drawn to the area east of Zaca Creek; however, no water level monitoring wells are located in this area so these contours are inferred from other hydrogeologic information. The hydraulic gradient based on the contours ranges from 0.017 to 0.020 indicating an order of magnitude greater groundwater flow than indicated by the head difference between the two monitoring wells.

Based on the observed water levels for the two CMA monitoring wells, the contours appear to over-estimate the groundwater gradient in this area. However, the upper value for both estimates of hydraulic gradient (0.0015 and 0.020) have been used to provide a range of estimated groundwater flow velocities for this analysis.

The hydraulic gradient was calculated using the equation below:

$$\text{Hydraulic gradient} = \frac{\Delta h}{\Delta l}$$

Hydraulic Conductivity, K

Estimates of hydraulic conductivity are reported in the CMA Groundwater Sustainability Plan (Stetson, 2022). The estimated values for the Paso Robles Formation range from 1.5 feet per day for the calibrated numerical model, a reported average value of 5 feet per day, and a median value from well tests of 10 feet per day. Because of the uncertainty in the reported values, a value of 20 feet per day was selected (double the reported median value from well tests) for estimation of groundwater velocity in the Paso Robles Formation.

For the Careaga Sand, the hydraulic conductivity is greater in the upper Graciosa Member of the Buellton Aquifer. The reported range for the Graciosa Member is 5 to 90 feet per day; a value of 90 feet per day was selected for this analysis to provide a conservative, upper bound estimate of groundwater velocity.

Effective Porosity, n_e

Effective porosity is generally defined as the portion of the saturated media that contributes to groundwater flow (Stephens et al., 1998). Effective porosity is less than the total porosity because, even if the medium is fully saturated, not all of the water-filled pores are interconnected or contribute to flow. Field tracer tests provide the most direct method for obtaining effective porosity; effective porosity cannot be reliably estimated from particle size, specific yield, or from measurements of soil-water retention (Stephens et al., 1998). Therefore, effective porosity is typically estimated using professional judgment.

No estimates of porosity are provided in the GSA report. Total porosity of sand and gravel aquifers generally ranges from 20 to 35 percent (Fetter, 1994). Effective porosity was estimated as 0.12 for use in estimating groundwater velocity in the Buellton Aquifer.

Estimated Velocity, v

Groundwater velocity near the City of Buellton was estimated to range from 0.24 to 3.3 feet per day in the Paso Robles Formation and from 1.1 up to 15 feet per day in the Careaga Sand as shown in Table D.1 depending on the selected value for hydraulic gradient. Based on these velocities, estimated travel distances in the Paso Robles Formation range from 44 feet for six months up to about 1,200 feet for twelve months. In the Careaga Sand, estimated travel distances range from about 200 feet for six months up to about 5,400 feet for 12 months.

The estimated groundwater velocity was calculated using the following equation:

$$Velocity \left(\frac{feet}{day} \right) = -\frac{K}{n} * \left(\frac{\Delta h}{\Delta l} \right)$$

Table D.1 Groundwater Velocity and Travel Time Estimates for the Buellton Aquifer

Unit	Paso Robles		Careaga/Graciosa	
K (feet per day)	20		90	
n_e	0.12		0.12	
i (feet per foot)	0.020	0.0014	0.020	0.0014
v (feet per day)	3.3	0.24	15	1.1
Distance _{6 months} (feet)	600	44	2,700	200
Distance _{12 months} (feet)	1,200	90	5,400	400

Notes:

i - hydraulic gradient; K - hydraulic conductivity; n_e - porosity; v - velocity

Careaga Sand Near Solvang

Hydraulic Gradient, $\Delta h/\Delta l$

Groundwater in the Careaga Sand in the southwestern part of the EMA north of the City of Solvang generally flows to the southeast beneath the upland areas towards the Santa Ynez River. Groundwater elevation monitoring data for spring and fall 2021 and 2022 provided in the EMA GSA Annual Report were used to estimate the hydraulic gradient near Solvang.

The EMA monitoring network includes several wells in the Careaga Sand in the southwestern part of the GSA. Based on the contour maps presented in the EMA GSA Annual Report, the gradient is steeper south

of Well 09Q02; because the area south of this well is closer to city and would provide a more conservative travel time analysis, the hydraulic gradient was estimated using the data for the three southern wells in the EMA GSA monitoring network (09Q02, HCA_South, and 16N07).

The hydraulic gradient was calculated for the four monitoring periods (spring and fall 2021 and 2022) included in the most recent EMA GSA Annual Report. The gradient ranges from 0.032 to 0.037, and the highest value of 0.037 was selected for used to estimate groundwater flow velocities for this analysis.

Hydraulic Conductivity, K

Estimates of hydraulic conductivity are reported in the EMA Groundwater Sustainability Plan (GSI, 2022). The estimated values for the Careaga Sand range from 0.8 to 20 feet per day with an average of 7.5 feet per day. The high value of 20 feet per day was selected for estimation of groundwater velocity in the Careaga Sand.

Effective Porosity, n_e

Effective porosity is generally defined as the portion of the saturated media that contributes to groundwater flow (Stephens et al., 1998). Effective porosity is less than the total porosity because, even if the medium is fully saturated, not all of the water-filled pores are interconnected or contribute to flow. Field tracer tests provide the most direct method for obtaining effective porosity; effective porosity cannot be reliably estimated from particle size, specific yield, or from measurements of soil–water retention (Stephens et al., 1998). Therefore, effective porosity is typically estimated using professional judgment.

A porosity of 0.12 for the Careaga Sand is provided in the GSA report. Effective porosity was estimated as 0.12 for use in estimating groundwater velocity in the Careaga Sand.

Estimated Velocity, v

Groundwater velocity near the City of Solvang was estimated to be 6.2 feet per day in the Careaga Sand as shown in Table D.2. Based on this velocity, estimated travel distances in the Careaga Sand range from 1,100 feet for 6 months up to about 2,300 feet for 12 months.

The estimated groundwater velocity was calculated using the following equation:

$$Velocity \left(\frac{ft}{day} \right) = -\frac{K}{n} * \left(\frac{\Delta h}{\Delta l} \right)$$

Table D.2 Groundwater Velocity and Travel Time Estimates for the Solvang Aquifer

Unit	Careaga Sand
K (feet per day)	20
n_e	0.12
i (feet per foot)	0.037
v (feet per day)	6.2
Distance _{6 months} (feet)	1,100
Distance _{12 months} (feet)	2,300

References

GSI, 2022. Santa Ynez River Valley Groundwater Basin – Eastern Management Area Groundwater Sustainability Plan. Prepared for the Eastern Management Area Groundwater Sustainability Agency.

Stetson (Stetson Engineers), 2022. Groundwater Sustainability Plan. Santa Ynez River Valley Groundwater Basin Central Management Area. Prepared for Central Management Area Groundwater Sustainability Agency.

APPENDIX E

DETAILED COST ESTIMATES

Solvang, DPR

PROJECT:	Santa Barbara Countywide Potable Reuse Evaluation			
JOB NO.:	201798			
ALTERNATIVE:	Solvang			
COST:	DPR - Treatment Process Equipment and Building			
DESCRIPTION:	Level 5 Cost Estimate			
CAPITAL COST ESTIMATE				
Classification	Quantity	Units	Unit Cost	Estimated Cost ⁽¹⁾
Equalization Tank				
Below Grade Coated Concrete Tank ⁽²⁾	1	LS	\$ 25,997,000	\$ 25,997,000
			Subtotal	\$ 25,997,000
AWPF Building				
AWPF Building	26,613	ft ²	\$ 450	\$ 11,976,000
Waste EQ Channel	1	LS	\$ 952,000	\$ 952,000
			Subtotal	\$ 12,928,000
Treatment Processes				
Ozone Generation and Injection	1	LS	\$ 2,900,000	\$ 2,900,000
Biological Activated Carbon Filters	1	LS	\$ 1,120,000	\$ 1,120,000
Ultrafiltration	1	LS	\$ 1,460,000	\$ 1,460,000
Reverse Osmosis	1	LS	\$ 1,530,000	\$ 1,530,000
UV Advanced Oxidation (LBX 850)	2	EA	\$ 118,500	\$ 237,000
Secondary UV (Spektron 350)	2	EA	\$ 43,800	\$ 88,000
Calcite Contactors	1	LS	\$ 520,000	\$ 520,000
Water Quality/CCP Instrumentation	1	LS	\$ 170,000	\$ 170,000
			Subtotal	\$ 8,025,000
Chemical Dosing Equipment, Tanks and Pumps ⁽³⁾				
BAF Feed Pumps	25	hp	\$ 25,000	\$ 625,000
BAF Backwash/MF Feed Tank	1	LS	\$ 101,000	\$ 101,000
Sodium Hypochlorite Tank	1	LS	\$ 23,000	\$ 23,000
Sodium Hypochlorite Dosing Pumps	8	pumps	\$ 11,000	\$ 88,000
Sodium Hydroxide Tank	1	LS	\$ 160,000	\$ 160,000
Sodium Hydroxide Dosing Pumps	4	pumps	\$ 11,000	\$ 44,000
Sulfuric Acid Tank	1	LS	\$ 160,000	\$ 160,000
Sulfuric Acid Dosing Pumps	4	pumps	\$ 11,000	\$ 44,000
Tote System Pumps	12	pumps	\$ 11,000	\$ 132,000
MF CIP Tank	1	LS	\$ 11,000	\$ 11,000
MF Backwash/RO Feed Tank	1	LS	\$ 23,000	\$ 23,000
Hot Water Tank	1	LS	\$ 11,000	\$ 11,000
RO CIP Tank	1	LS	\$ 11,000	\$ 11,000
RO Permeate Flush Tank	1	LS	\$ 9,000	\$ 9,000
UVAOP Feed Tank	1	LS	\$ 9,000	\$ 9,000
Chlorine Contact Tank	1	LS	\$ 46,000	\$ 46,000
Blending Tank	1	LS	\$ 487,000	\$ 487,000
Waste EQ Diversion Pumps	25	hp	\$ 25,000	\$ 625,000
Waste EQ Pumps	2	hp	\$ 25,000	\$ 50,000
			Subtotal	\$ 2,659,000
Treatment Facility Items ⁽⁴⁾				
Process Equipment Installation			25%	\$ 2,671,000
Piping and valves			20%	\$ 2,137,000
			Subtotal	\$ 4,808,000
Engineering Services				
Civil and Sitework			10%	\$ 8,372,000
Electrical & I/C			25%	\$ 20,930,000
			Subtotal	\$ 29,302,000
Total Direct Cost				\$ 83,719,000

Solvang, DPR

PROJECT:	Santa Barbara Countywide Potable Reuse Evaluation			
JOB NO.:	201798			
ALTERNATIVE:	Solvang			
COST:	DPR - Treatment Process Equipment and Building			
DESCRIPTION:	Level 5 Cost Estimate			
CAPITAL COST ESTIMATE				
Classification	Quantity	Units	Unit Cost	Estimated Cost⁽¹⁾
Estimating Contingency	30%		\$	25,116,000
Sales Tax (applied to 50% of direct costs)	7.75%		\$	3,245,000
Contractor Overhead & Profit	15%		\$	16,326,000
General Conditions	20%		\$	21,767,000
TOTAL CONSTRUCTION COST			\$	150,173,000
Engineering, Legal, and Administrative	12%		\$	18,021,000
Owners Reserve for Change Orders	5%		\$	7,509,000
TOTAL PROJECT COST			\$	175,700,000
Notes				
<ol style="list-style-type: none"> 1. Expressed in 2023 dollars. 2. 240' x 160' x 15' Submerged Concrete EQ Tank. The EQ tank could be removed or significantly reduced in size from this project if the peak wet weather flow does not have to be captured. This is pending discussions with the RWQCB. 3. Does not include pumps or equipment included in scope of supply for process (e.g. MF Feed Pumps) or infrastructure cost (finished water pumps, ROC pumps etc) 4. Treatment facility items are scaled as a factor of direct Treatment Processes and Chemical Dosing Equipment and Tanks, excluding building and other Engineering Services 				

Solvang, DPR

PROJECT:	Santa Barbara Countywide Potable Reuse Evaluation
JOB NO.:	201798
ALTERNATIVE:	Solvang
COST:	DPR - Treatment Process Opex
DESCRIPTION:	Level 5 Cost Estimate

O&M COST ESTIMATE					
Classification	Quantity	Units	Unit Cost	Annual Cost ⁽¹⁾	
Staffing Cost					
Utility Operator ⁽²⁾	6	\$/yr.	\$150,000		\$900,000
			Subtotal \$		900,000
Process Energy Costs⁽³⁾					
O3/BAF	33.9	kW	\$ 0.35	\$	103,900
UF	2.25	kW	\$ 0.35	\$	6,900
RO	1.82	kWh/kgal	\$ 0.35	\$	100,000
UVAOP	12.4	kW	\$ 0.35	\$	38,000
Secondary UV	1.1	kW	\$ 0.35	\$	3,500
			Subtotal \$		252,300
Process Chemical Usage⁽⁴⁾					
Sodium Hypochlorite (12.5 wt%)	51	lbs/d	\$ 2.12	\$	39,800
Sodium Hydroxide (50 wt%)	658	lbs/d	\$ 0.29	\$	69,600
Ammonium Sulfate (40 wt%)	3	lbs/d	\$ 0.45	\$	500
Liquid Oxygen	100	lbs/d	\$ 0.09	\$	3,300
Sulfuric Acid (93 wt%)	563	lbs/d	\$ 0.29	\$	59,700
Antiscalant	23	lbs/d	\$ 5.22	\$	43,000
Citric Acid 50%	53	lbs/d	\$ 5.80	\$	112,100
Calcite	172	lbs/d	\$ 0.31	\$	19,500
			Subtotal \$		347,500
Process Consumables Costs					
UF Membrane Replacement ⁽⁵⁾	1	\$/yr.	\$ 16,300.00	\$	16,300
RO Membrane Replacement ⁽⁵⁾	1	\$/yr.	\$ 12,500.00	\$	12,500
UVAOP Lamp Replacement ⁽⁶⁾	1	\$/yr.	\$ 7,600.00	\$	7,600
Secondary UV Lamp Replacement ⁽⁶⁾	1	\$/yr.	\$ 800.00	\$	800
			Subtotal \$		37,200
Additional Pumping⁽⁷⁾					
Waste EQ	0.9	kW	\$ 0.35	\$	2,800
			Subtotal \$		2,800
TOTAL O&M COST				\$	1,539,800

Notes

- Expressed in 2023 dollars.
- DPR staffing based upon doubling the City of Morro Bay 1 mgd IPR AWWP for 12 hours per day staffing. Costs assume a fully burdened rate of \$72/hour for staff.
- Process Energy Costs and Chemical Usage are Calculated Assuming Average (not peak) Flows
- Estimated from Projections and Material Balance
- Replacement of Duty Membranes Every 7 Years, Reported as Annualized Cost Based on a Sinking Fund Factor
- Replacement of Duty Lamps Every 2 Years, Reported as Annualized Costs Based on a Sinking Fund Factor
- Considers only Pumping Costs not Already Incorporated into Process Energy

Solvang, IPR

PROJECT:	Santa Barbara Countywide Potable Reuse Evaluation			
JOB NO.:	201798			
ALTERNATIVE:	Solvang			
COST:	IPR - Treatment Process Equipment and Building			
DESCRIPTION:	Level 5 Cost Estimate			
CAPITAL COST ESTIMATE				
Classification	Quantity	Units	Unit Cost	Estimated Cost ⁽¹⁾
Equalization Tank				
3.48 MG Below Grade Coated Concrete Tank ⁽²⁾	1	LS	\$ 25,997,000	\$ 25,997,000
			Subtotal	\$ 25,997,000
AWPF Building				
AWPF Building	16,601	ft ²	\$ 450	\$ 7,471,000
Waste EQ Channel	1	LS	\$ 628,000	\$ 628,000
			Subtotal	\$ 8,099,000
Treatment Processes				
Ultrafiltration	1	LS	\$ 1,820,000	\$ 1,820,000
Reverse Osmosis	1	LS	\$ 1,540,000	\$ 1,540,000
UV Advanced Oxidation (LBX 850)	2	EA	\$ 118,500	\$ 237,000
Calcite Contactors	1	LS	\$ 520,000	\$ 520,000
Water Quality/CCP Instrumentation	1	LS	\$ 112,500	\$ 113,000
			Subtotal	\$ 4,230,000
Chemical Dosing Equipment, Tanks and Pumps ⁽³⁾				
Sodium Hypochlorite Tank	1	LS	\$ 23,000	\$ 23,000
Sodium Hypochlorite Dosing Pumps	8	pumps	\$ 11,000	\$ 88,000
Sodium Hydroxide Tank	1	LS	\$ 160,000	\$ 160,000
Sodium Hydroxide Dosing Pumps	4	pumps	\$ 11,000	\$ 44,000
Sulfuric Acid Tank	1	LS	\$ 160,000	\$ 160,000
Sulfuric Acid Dosing Pumps	4	pumps	\$ 11,000	\$ 44,000
Tote System Pumps	12	pumps	\$ 11,000	\$ 132,000
MF CIP Tank	1	LS	\$ 11,000	\$ 11,000
MF Backwash/RO Feed Tank	1	LS	\$ 23,000	\$ 23,000
Hot Water Tank	1	LS	\$ 11,000	\$ 11,000
RO CIP Tank	1	LS	\$ 11,000	\$ 11,000
RO Permeate Flush Tank	1	LS	\$ 9,000	\$ 9,000
UVAOP Feed Tank	1	LS	\$ 9,000	\$ 9,000
Chlorine Contact Tank	1	LS	\$ 46,000	\$ 46,000
Waste EQ Diversion Pumps	25	hp	\$ 25,000	\$ 625,000
Waste EQ Pumps	2	hp	\$ 25,000	\$ 50,000
			Subtotal	\$ 1,446,000
Treatment Facility Items ⁽⁴⁾				
Process Equipment Installation			25%	\$ 1,419,000
Piping and valves			20%	\$ 1,136,000
			Subtotal	\$ 2,555,000
Engineering Services				
Civil and Sitework			10%	\$ 6,512,000
Electrical & I/C			25%	\$ 16,280,000
			Subtotal	\$ 22,792,000
Total Direct Cost			\$	65,119,000

Solvang, IPR

PROJECT:	Santa Barbara Countywide Potable Reuse Evaluation			
JOB NO.:	201798			
ALTERNATIVE:	Solvang			
COST:	IPR - Treatment Process Equipment and Building			
DESCRIPTION:	Level 5 Cost Estimate			
CAPITAL COST ESTIMATE				
Classification	Quantity	Units	Unit Cost	Estimated Cost⁽¹⁾
Estimating Contingency	30%		\$	19,536,000
Sales Tax (applied to 50% of direct costs)	7.75%		\$	2,524,000
Contractor Overhead & Profit	15%		\$	12,699,000
General Conditions	20%		\$	16,931,000
TOTAL CONSTRUCTION COST			\$	116,809,000
Engineering, Legal, and Administrative	12%		\$	14,017,000
Owners Reserve for Change Orders	5%		\$	5,840,000
TOTAL PROJECT COST			\$	136,670,000
Notes				
<ol style="list-style-type: none"> 1. Expressed in 2023 dollars. 2. 240' x 160' x 15' Submerged Concrete EQ Tank. The EQ tank could be removed or significantly reduced in size from this project if the peak wet weather flow does not have to be captured. This is pending discussions with the RWQCB. 3. Does not include pumps or equipment included in scope of supply for process (e.g. MF Feed Pumps) or infrastructure cost (finished water pumps, ROC pumps etc) 4. Treatment facility items are scaled as a factor of direct Treatment Processes and Chemical Dosing Equipment and Tanks, excluding building and other Engineering Services 				

Solvang, IPR

PROJECT:	Santa Barbara Countywide Potable Reuse Evaluation
JOB NO.:	201798
ALTERNATIVE:	Solvang
COST:	IPR - Treatment Process Opex
DESCRIPTION:	Level 5 Cost Estimate

O&M COST ESTIMATE					
Classification	Quantity	Units	Unit Cost	Annual Cost ⁽¹⁾	
Staffing Cost					
Utility Operator ⁽²⁾	3	\$/yr.	\$150,000		\$450,000
			Subtotal \$		450,000
Process Energy Costs⁽³⁾					
UF	2.07	kW	\$ 0.35	\$	6,400
RO	1.93	kWh/kgal	\$ 0.35	\$	113,500
UVAOP	12.6	kW	\$ 0.35	\$	38,500
			Subtotal \$		158,400
Process Chemical Usage⁽⁴⁾					
Sodium Hypochlorite (12.5 wt%)	54	lbs/d	\$ 2.12	\$	42,100
Sodium Hydroxide (50 wt%)	703	lbs/d	\$ 0.29	\$	74,500
Ammonium Sulfate (40 wt%)	3	lbs/d	\$ 0.45	\$	500
Sulfuric Acid (93 wt%)	595	lbs/d	\$ 0.29	\$	63,000
Antiscalant	24	lbs/d	\$ 5.22	\$	45,400
Citric Acid 50%	53	lbs/d	\$ 5.80	\$	112,100
Calcite	183	lbs/d	\$ 0.31	\$	20,800
			Subtotal \$		358,400
Process Consumables Costs					
UF Membrane Replacement ⁽⁵⁾	1	\$/yr.	\$ 35,500.00	\$	35,500
RO Membrane Replacement ⁽⁵⁾	1	\$/yr.	\$ 12,500.00	\$	12,500
UVAOP Lamp Replacement ⁽⁶⁾	1	\$/yr.	\$ 7,600.00	\$	7,600
			Subtotal \$		55,600
Additional Pumping⁽⁷⁾					
Waste EQ	1.0	kW	\$ 0.35	\$	3,300
RO Concentrate	4.0	kW	\$ 0.35	\$	12,200
Finished Water	16.0	kW	\$ 0.35	\$	49,200
			Subtotal \$		64,700
TOTAL O&M COST				\$	1,087,100

Notes

- Expressed in 2023 dollars.
- IPR staffing based the City of Morro Bay 1 mgd IPR AWPf for 12 hours per day staffing. Costs assume a fully burdened rate of \$72/hour for staff.
- Process Energy Costs and Chemical Usage are Calculated Assuming Average (not peak) Flows
- Estimated from Projections and Material Balance
- Replacement of Duty Membranes Every 7 Years, Reported as Annualized Cost Based on a Sinking Fund Factor
- Replacement of Duty Lamps Every 2 Years, Reported as Annualized Costs Based on a Sinking Fund Factor
- Considers only Pumping Costs not Already Incorporated into Process Energy

Solvang, DPR

STUDY TITLE:	Santa Barbara Countywide Potable Reuse Evaluation				
JOB NO.:	201798				
PROJECT:	Solvang				
ALTERNATIVE:	DPR - Infrastructure				
DESCRIPTION:	Level 5 Cost Estimate				
CAPITAL COST ESTIMATE					
Classification	Quantity	Units	Unit Cost	Estimated Cost⁽¹⁾	
Feedwater Piping					
WWTP Effluent to EQ Basin (16" Diameter)	600	LF	\$ 310	\$	186,000
EQ Basin to AWPFI Influent (10" Diameter)	300	LF	\$ 155	\$	47,000
			Subtotal	\$	233,000
Finished Water Piping					
8" Diameter, Open Field	4,200	LF	\$ 130	\$	546,000
			Subtotal	\$	546,000
ROC Piping					
6" Diameter, Open Field	3,100	LF	\$ 100	\$	310,000
6" Diameter, Developed	8,550	LF	\$ 160	\$	1,368,000
6" Diameter, Trenchless River Crossing	750	LF	\$ 480	\$	360,000
			Subtotal	\$	2,038,000
Waste/Backwash Return Piping					
8" Diameter, Mostly Open	800	LF	\$ 160	\$	128,000
			Subtotal	\$	128,000
Pump Station Cost					
Finished Water Pump Station	50	hp	\$ 21,500	\$	1,075,000
ROC Pump Station	25	hp	\$ 25,000	\$	625,000
			Subtotal	\$	1,700,000
Pump Station Allowances					
Process Equipment Installation			25%	\$	425,000
Sitework			15%	\$	255,000
			Subtotal	\$	680,000
ROC Injection Wells					
Permitting	1	LS	\$ 150,000	\$	150,000
Injection Wells	2	ea	\$ 2,400,000	\$	4,800,000
Surface Facilities (tanks, pumps, piping, monitoring)	2	LS	\$ 500,000	\$	1,000,000
			Subtotal	\$	5,950,000
Total Direct Cost				\$	11,275,000

Solvang, DPR

STUDY TITLE:	Santa Barbara Countywide Potable Reuse Evaluation			
JOB NO.:	201798			
PROJECT:	Solvang			
ALTERNATIVE:	DPR - Infrastructure			
DESCRIPTION:	Level 5 Cost Estimate			
CAPITAL COST ESTIMATE				
Classification	Quantity	Units	Unit Cost	Estimated Cost⁽¹⁾
Estimating Contingency	30%		\$	3,383,000
Sales Tax (applied to 50% of direct costs) ⁽²⁾	7.75%		\$	437,000
Contractor Overhead & Profit	15%		\$	2,199,000
General Conditions	20%		\$	2,932,000
TOTAL CONSTRUCTION COST			\$	20,226,000
Engineering, Legal, and Administrative	12%		\$	2,427,000
Owners Reserve for Change Orders	5%		\$	1,011,000
TOTAL PROJECT COST			\$	23,660,000
Notes				
1. Expressed in 2023 dollars.				

Solvang, IPR

STUDY TITLE:	Santa Barbara Countywide Potable Reuse Evaluation				
JOB NO.:	201798				
PROJECT:	Solvang				
ALTERNATIVE:	IPR - Infrastructure, to 6 Month Injection Point				
DESCRIPTION:	Level 5 Cost Estimate				
CAPITAL COST ESTIMATE					
Classification	Quantity	Units	Unit Cost	Estimated Cost ⁽¹⁾	
Feedwater Piping					
WWTP Effluent to EQ Basin (16" Diameter)	600	LF	\$ 310	\$	186,000
EQ Basin to AWPFI Influent (10" Diameter)	300	LF	\$ 155	\$	47,000
			Subtotal	\$	233,000
Finished Water Piping					
8" Diameter, Open Field	1,850	LF	\$ 130	\$	241,000
8" Diameter, Developed	3,590	LF	\$ 210	\$	754,000
8" Diameter, Trenchless River Crossing	750	LF	\$ 630	\$	473,000
			Subtotal	\$	1,468,000
ROC Piping					
6" Diameter, Open Field	3,100	LF	\$ 100	\$	310,000
6" Diameter, Developed	8,550	LF	\$ 160	\$	1,368,000
6" Diameter, Trenchless River Crossing	750	LF	\$ 480	\$	360,000
			Subtotal	\$	2,038,000
Waste/Backwash Return Piping					
8" Diameter, Mostly Open	800	LF	\$ 160	\$	128,000
			Subtotal	\$	128,000
Pump Station Cost					
Finished Water Pump Station	75	hp	\$ 21,500	\$	1,612,500
ROC Pump Station	25	hp	\$ 25,000	\$	625,000
			Subtotal	\$	2,237,500
Pump Station Allowances					
Process Equipment Installation			25%	\$	559,000
Sitework			15%	\$	336,000
			Subtotal	\$	895,000
Finished Water Injection Wells					
Onsite Recycled Water Pump Station & Tank	1	LS	\$ 1,313,000	\$	1,313,000
Injection Sites - General Requiements and Site Civil	1	LS	\$ 1,107,600	\$	1,108,000
Injection Wells	1	LS	\$ 2,475,000	\$	2,475,000
Supporting EI&C	1	LS	\$ 477,900	\$	478,000
			Subtotal	\$	5,374,000

Solvang, IPR

STUDY TITLE:	Santa Barbara Countywide Potable Reuse Evaluation			
JOB NO.:	201798			
PROJECT:	Solvang			
ALTERNATIVE:	IPR - Infrastructure, to 6 Month Injection Point			
DESCRIPTION:	Level 5 Cost Estimate			
CAPITAL COST ESTIMATE				
Classification	Quantity	Units	Unit Cost	Estimated Cost⁽¹⁾
ROC Injection Wells				
Permitting	1	LS	\$ 150,000	\$ 150,000
Injection Wells	2	ea	\$ 2,400,000	\$ 4,800,000
Surface Facilities (tanks, pumps, piping, monitoring)	2	LS	\$ 500,000	\$ 1,000,000
			Subtotal	\$ 5,950,000
Total Direct Cost				\$ 18,324,000
Estimating Contingency	30%		\$	5,497,000
Sales Tax (applied to 50% of direct costs)	7.75%		\$	710,000
Contractor Overhead & Profit	15%		\$	3,573,000
General Conditions	20%		\$	4,764,000
TOTAL CONSTRUCTION COST				\$ 32,868,000
Engineering, Legal, and Administrative	12%		\$	3,944,000
Owners Reserve for Change Orders	5%		\$	1,643,000
TOTAL PROJECT COST				\$ 38,460,000
Notes	1. Expressed in 2023 dollars.			

Solvang, IPR

STUDY TITLE:	Santa Barbara Countywide Potable Reuse Evaluation				
JOB NO.:	201798				
PROJECT:	Solvang				
ALTERNATIVE:	IPR - Infrastructure, to 12 Month Injection Point				
DESCRIPTION:	Level 5 Cost Estimate				
CAPITAL COST ESTIMATE					
Classification	Quantity	Units	Unit Cost	Estimated Cost ⁽¹⁾	
Feedwater Piping					
WWTP Effluent to EQ Basin (16" Diameter)	600	LF	\$ 310	\$	186,000
EQ Basin to AWPFI Influent (10" Diameter)	300	LF	\$ 155	\$	47,000
			Subtotal	\$	233,000
Finished Water Piping					
8" Diameter, Open Field	3,450	LF	\$ 130	\$	449,000
8" Diameter, Developed	7,300	LF	\$ 210	\$	1,533,000
8" Diameter, Trenchless River Crossing	750	LF	\$ 630	\$	473,000
			Subtotal	\$	2,455,000
ROC Piping					
6" Diameter, Open Field	3,100	LF	\$ 100	\$	310,000
6" Diameter, Developed	8,550	LF	\$ 160	\$	1,368,000
6" Diameter, Trenchless River Crossing	750	LF	\$ 480	\$	360,000
			Subtotal	\$	2,038,000
Waste/Backwash Return Piping					
8" Diameter, Mostly Open	800	LF	\$ 160	\$	128,000
			Subtotal	\$	128,000
Pump Station Cost					
Finished Water Pump Station	75	hp	\$ 21,500	\$	1,612,500
ROC Pump Station	25	hp	\$ 25,000	\$	625,000
			Subtotal	\$	2,237,500
Pump Station Allowances					
Process Equipment Installation			25%	\$	559,000
Sitework			15%	\$	336,000
			Subtotal	\$	895,000
Finished Water Injection Wells					
Onsite Recycled Water Pump Station & Tank	1	LS	\$ 1,313,000	\$	1,313,000
Injection Sites - General Requiements and Site Civil	1	LS	\$ 1,107,600	\$	1,108,000
Injection Wells	1	LS	\$ 2,475,000	\$	2,475,000
Supporting EI&C	1	LS	\$ 477,900	\$	478,000
			Subtotal	\$	5,374,000
ROC Injection Wells					
Permitting	1	LS	\$ 150,000	\$	150,000
Injection Wells	2	ea	\$ 2,400,000	\$	4,800,000
Surface Facilities (tanks, pumps, piping, monitoring)	2	LS	\$ 500,000	\$	1,000,000
			Subtotal	\$	5,950,000
Total Direct Cost				\$	19,310,500

Solvang, IPR

STUDY TITLE:	Santa Barbara Countywide Potable Reuse Evaluation			
JOB NO.:	201798			
PROJECT:	Solvang			
ALTERNATIVE:	IPR - Infrastructure, to 12 Month Injection Point			
DESCRIPTION:	Level 5 Cost Estimate			
CAPITAL COST ESTIMATE				
Classification	Quantity	Units	Unit Cost	Estimated Cost⁽¹⁾
Estimating Contingency	30%		\$	5,793,000
Subtotal			\$	25,103,500
Sales Tax (applied to 50% of direct costs)	8.75%		\$	1,098,000
Subtotal			\$	26,201,500
Contractor Overhead & Profit	15%		\$	3,930,000
Subtotal			\$	30,131,500
General Conditions	20%		\$	6,026,000
Subtotal			\$	36,157,500
TOTAL CONSTRUCTION COST				\$ 36,157,500
Engineering, Legal, and Administrative	12%		\$	4,339,000
Subtotal			\$	40,496,500
Owners Reserve for Change Orders	5%		\$	1,808,000
Subtotal			\$	42,304,500
TOTAL PROJECT COST				\$ 42,300,000
Notes				
1. Expressed in 2023 dollars.				

Solvang

STUDY TITLE:	Santa Barbara Countywide Potable Reuse Evaluation
JOB NO.:	201798
PROJECT:	Solvang
ALTERNATIVE:	IPR and DPR Infrastructure O&M Costs
DESCRIPTION:	Level 5 Cost Estimate

O&M Item	Quantity			Unit	Unit Cost	Annual Cost ⁽¹⁾		
	IPR, 6 Month	IPR, 12 Month	DPR			IPR, 6 Month	IPR, 12 Month	DPR
Power	See footnote (2)							
Feedwater PS				KW-hr/year	\$0.35			
Finished Water PS	490,122	490,122	326,748	KW-hr/year	\$0.35	\$172,000	\$172,000	\$115,000
ROC PS	163,374	163,374	163,374	KW-hr/year	\$0.35	\$58,000	\$58,000	\$58,000
Annual Maintenance	See footnote (3)					\$192,000	\$212,000	\$118,000
TOTAL ESTIMATED ANNUAL O&M COSTS						\$422,000	\$442,000	\$291,000

(1) Expressed in 2023 dollars.

(2) Feedwater pumping not estimated at this level of detail. There will likely be a small pump station required to transport water from the WWTP to the AWPf that should be considered should this project move forward.

(3) Annual maintenance estimated as 0.5% of total capital costs.

Buellton, DPR

PROJECT:	Santa Barbara Countywide Potable Reuse Evaluation				
JOB NO.:	201798				
ALTERNATIVE:	Buellton				
COST:	DPR - Treatment Process Equipment and Building				
DESCRIPTION:	Level 5 Cost Estimate				
CAPITAL COST ESTIMATE					
Classification	Quantity	Units	Unit Cost	Estimated Cost ⁽¹⁾	
Equalization Tank					
EQ Tank ⁽²⁾	1	LS	\$ 318,000	\$	318,000
			Subtotal	\$	318,000
AWPF Building					
AWPF Building	22,969	ft ²	\$ 450	\$	10,337,000
Waste EQ Channel	1	LS	\$ 714,000	\$	714,000
			Subtotal	\$	11,051,000
Treatment Processes					
Ozone Generation and Injection	1	LS	\$ 2,500,000	\$	2,500,000
Biological Activated Carbon Filters	1	LS	\$ 810,000	\$	810,000
Ultrafiltration	1	LS	\$ 1,290,000	\$	1,290,000
Reverse Osmosis	1	LS	\$ 1,120,000	\$	1,120,000
UV Advanced Oxidation (Spektron 650)	2	EA	\$ 76,500	\$	153,000
Secondary UV (Spektron 250)	2	EA	\$ 35,400	\$	71,000
Calcite Contactors	1	LS	\$ 470,000	\$	470,000
Water Quality/CCP Instrumentation	1	LS	\$ 170,000	\$	170,000
			Subtotal	\$	6,584,000
Chemical Dosing Equipment, Tanks and Pumps ⁽³⁾					
BAF Feed Pumps	10	hp	\$ 25,000	\$	250,000
BAF Backwash/MF Feed Tank	1	LS	\$ 67,000	\$	67,000
Sodium Hypochlorite Tank	1	LS	\$ 23,000	\$	23,000
Sodium Hypochlorite Dosing Pumps	8	pumps	\$ 11,000	\$	88,000
Sodium Hydroxide Tank	1	LS	\$ 160,000	\$	160,000
Sodium Hydroxide Dosing Pumps	4	pumps	\$ 11,000	\$	44,000
Sulfuric Acid Tank	1	LS	\$ 160,000	\$	160,000
Sulfuric Acid Dosing Pumps	4	pumps	\$ 11,000	\$	44,000
Tote System Pumps	12	pumps	\$ 11,000	\$	132,000
MF CIP Tank	1	LS	\$ 11,000	\$	11,000
MF Backwash/RO Feed Tank	1	LS	\$ 23,000	\$	23,000
Hot Water Tank	1	LS	\$ 11,000	\$	11,000
RO CIP Tank	1	LS	\$ 11,000	\$	11,000
RO Permeate Flush Tank	1	LS	\$ 9,000	\$	9,000
UVAOP Feed Tank	1	LS	\$ 9,000	\$	9,000
Chlorine Contact Tank	1	LS	\$ 16,000	\$	16,000
Blending Tank	1	LS	\$ 350,000	\$	350,000
Waste EQ Diversion Pumps	10	hp	\$ 25,000	\$	250,000
Waste EQ Pumps	1	hp	\$ 25,000	\$	25,000
			Subtotal	\$	1,683,000
Treatment Facility Items ⁽⁴⁾					
Process Equipment Installation			25%	\$	2,067,000
Piping and valves			20%	\$	1,654,000
			Subtotal	\$	3,721,000
Engineering Services					
Civil and Sitework			10%	\$	3,594,000
Electrical & I/C			25%	\$	8,984,000
			Subtotal	\$	12,578,000
Total Direct Cost				\$	35,935,000

Buellton, DPR

PROJECT:	Santa Barbara Countywide Potable Reuse Evaluation			
JOB NO.:	201798			
ALTERNATIVE:	Buellton			
COST:	DPR - Treatment Process Equipment and Building			
DESCRIPTION:	Level 5 Cost Estimate			
CAPITAL COST ESTIMATE				
Classification	Quantity	Units	Unit Cost	Estimated Cost⁽¹⁾
Estimating Contingency	30%		\$	10,781,000
Sales Tax (applied to 50% of direct costs)	7.75%		\$	1,393,000
Contractor Overhead & Profit	15%		\$	7,008,000
General Conditions	20%		\$	9,344,000
TOTAL CONSTRUCTION COST			\$	64,461,000
Engineering, Legal, and Administrative	12%		\$	7,735,000
Owners Reserve for Change Orders	5%		\$	3,223,000
TOTAL PROJECT COST			\$	75,420,000
Notes				
1. Expressed in 2023 dollars.				
2. 13' tall, 48' diameter steel EQ Tank				
3. Does not include pumps or equipment included in scope of supply for process (e.g. MF Feed Pumps) or infrastructure cost (finished water pumps, ROC pumps etc)				
4. Treatment facility items are scaled as a factor of direct Treatment Processes and Chemical Dosing Equipment and Tanks, excluding building and other Engineering Services				

Buellton, DPR

PROJECT:	Santa Barbara Countywide Potable Reuse Evaluation
JOB NO.:	201798
ALTERNATIVE:	Buellton
COST:	DPR - Treatment Process Opex
DESCRIPTION:	Level 5 Cost Estimate

O&M COST ESTIMATE					
Classification	Quantity	Units	Unit Cost	Annual Cost ⁽¹⁾	
Staffing Cost					
Utility Operator ⁽²⁾	6	\$/yr.	\$150,000		\$900,000
			Subtotal \$		900,000
Process Energy Costs⁽³⁾					
O3/BAF	24.2	kW	\$ 0.35	\$	74,300
UF	1.75	kW	\$ 0.35	\$	5,400
RO	1.75	kWh/kgal	\$ 0.35	\$	69,400
UVAOP	6.1	kW	\$ 0.35	\$	18,700
Secondary UV	0.9	kW	\$ 0.35	\$	2,700
			Subtotal \$		170,500
Process Chemical Usage⁽⁴⁾					
Sodium Hypochlorite (12.5 wt%)	41	lbs/d	\$ 2.12	\$	31,500
Sodium Hydroxide (50 wt%)	454	lbs/d	\$ 0.29	\$	48,100
Ammonium Sulfate (40 wt%)	2	lbs/d	\$ 0.45	\$	400
Liquid Oxygen	72	lbs/d	\$ 0.09	\$	2,400
Sulfuric Acid (93 wt%)	396	lbs/d	\$ 0.29	\$	42,000
Antiscalant	16	lbs/d	\$ 5.22	\$	30,300
Citric Acid 50%	53	lbs/d	\$ 5.80	\$	112,100
Calcite	148	lbs/d	\$ 0.31	\$	16,800
			Subtotal \$		283,600
Process Consumables Costs					
UF Membrane Replacement ⁽⁵⁾	1	\$/yr.	\$ 7,400.00	\$	7,400
RO Membrane Replacement ⁽⁵⁾	1	\$/yr.	\$ 4,700.00	\$	4,700
UVAOP Lamp Replacement ⁽⁶⁾	1	\$/yr.	\$ 1,900.00	\$	1,900
Secondary UV Lamp Replacement ⁽⁶⁾	1	\$/yr.	\$ 500.00	\$	500
			Subtotal \$		14,500
Additional Pumping⁽⁷⁾					
Waste EQ	0.7	kW	\$ 0.35	\$	2,100
			Subtotal \$		2,100
TOTAL O&M COST				\$	1,370,700

Notes

- Expressed in 2023 dollars.
- DPR staffing based upon doubling the City of Morro Bay 1 mgd IPR AWPf for 12 hours per day staffing. Costs assume a fully burdened rate of \$72/hour for staff.
- Process Energy Costs and Chemical Usage are Calculated Assuming Average (not peak) Flows
- Estimated from Projections and Material Balance
- Replacement of Duty Membranes Every 7 Years, Reported as Annualized Cost Based on a Sinking Fund Factor
- Replacement of Duty Lamps Every 2 Years, Reported as Annualized Costs Based on a Sinking Fund Factor
- Considers only Pumping Costs not Already Incorporated into Process Energy

Buellton, IPR

PROJECT:	Santa Barbara Countywide Potable Reuse Evaluation			
JOB NO.:	201798			
ALTERNATIVE:	Buellton			
COST:	IPR - Treatment Process Equipment and Building			
DESCRIPTION:	Level 5 Cost Estimate			
CAPITAL COST ESTIMATE				
Classification	Quantity	Units	Unit Cost	Estimated Cost ⁽¹⁾
Equalization Tank				
EQ Tank ⁽²⁾	1	LS	\$ 318,000	\$ 318,000
			Subtotal	\$ 318,000
AWPF Building				
AWPF Building	16,944	ft ²	\$ 450	\$ 7,625,000
Waste EQ Channel	1	LS	\$ 683,000	\$ 683,000
			Subtotal	\$ 8,308,000
Treatment Processes				
Ultrafiltration	1	LS	\$ 1,400,000	\$ 1,400,000
Reverse Osmosis	1	LS	\$ 1,130,000	\$ 1,130,000
UV Advanced Oxidation (Spektron 650)	2	EA	\$ 76,500	\$ 153,000
Calcite Contactors	1	LS	\$ 470,000	\$ 470,000
Water Quality/CCP Instrumentation	1	LS	\$ 112,500	\$ 113,000
			Subtotal	\$ 3,266,000
Chemical Dosing Equipment, Tanks and Pumps ⁽¹⁾				
Sodium Hypochlorite Tank	1	LS	\$ 23,000	\$ 23,000
Sodium Hypochlorite Dosing Pumps	8	pumps	\$ 11,000	\$ 88,000
Sodium Hydroxide Tank	1	LS	\$ 160,000	\$ 160,000
Sodium Hydroxide Dosing Pumps	4	pumps	\$ 11,000	\$ 44,000
Sulfuric Acid Tank	1	LS	\$ 160,000	\$ 160,000
Sulfuric Acid Dosing Pumps	4	pumps	\$ 11,000	\$ 44,000
Tote System Pumps	12	pumps	\$ 11,000	\$ 132,000
MF CIP Tank	1	LS	\$ 11,000	\$ 11,000
MF Backwash/RO Feed Tank	1	LS	\$ 23,000	\$ 23,000
Hot Water Tank	1	LS	\$ 11,000	\$ 11,000
RO CIP Tank	1	LS	\$ 11,000	\$ 11,000
RO Permeate Flush Tank	1	LS	\$ 9,000	\$ 9,000
UVAOP Feed Tank	1	LS	\$ 9,000	\$ 9,000
Chlorine Contact Tank	1	LS	\$ 16,000	\$ 16,000
Waste EQ Diversion Pumps	10	hp	\$ 25,000	\$ 250,000
Waste EQ Pumps	1	hp	\$ 25,000	\$ 25,000
			Subtotal	\$ 1,016,000
Treatment Facility Items ⁽²⁾				
Process Equipment Installation			25%	\$ 1,071,000
Piping and valves			20%	\$ 857,000
			Subtotal	\$ 1,928,000
Engineering Services				
Civil and Sitework			10%	\$ 2,283,000
Electrical & I/C			25%	\$ 5,707,000
			Subtotal	\$ 7,990,000
Total Direct Cost			\$	22,826,000

Buellton, IPR

PROJECT:	Santa Barbara Countywide Potable Reuse Evaluation			
JOB NO.:	201798			
ALTERNATIVE:	Buellton			
COST:	IPR - Treatment Process Equipment and Building			
DESCRIPTION:	Level 5 Cost Estimate			
CAPITAL COST ESTIMATE				
Classification	Quantity	Units	Unit Cost	Estimated Cost⁽¹⁾
Estimating Contingency	30%		\$	6,848,000
Sales Tax (applied to 50% of direct costs)	7.75%		\$	885,000
Contractor Overhead & Profit	15%		\$	4,452,000
General Conditions	20%		\$	5,935,000
TOTAL CONSTRUCTION COST			\$	40,946,000
Engineering, Legal, and Administrative	12%		\$	4,914,000
Owners Reserve for Change Orders	5%		\$	2,047,000
TOTAL PROJECT COST			\$	47,910,000
Notes				
1. Expressed in 2023 dollars.				
2. 13' tall, 48' diameter steel EQ Tank				
3. Does not include pumps or equipment included in scope of supply for process (e.g. MF Feed Pumps) or infrastructure cost (finished water pumps, ROC pumps etc)				
4. Treatment facility items are scaled as a factor of direct Treatment Processes and Chemical Dosing Equipment and Tanks, excluding building and other Engineering Services				

Buellton, IPR

PROJECT:	Santa Barbara Countywide Potable Reuse Evaluation				
JOB NO.:	201798				
ALTERNATIVE:	Buellton				
COST:	IPR - Treatment Process Opex				
DESCRIPTION:	Level 5 Cost Estimate				
O&M COST ESTIMATE					
Classification	Quantity	Units	Unit Cost	Annual Cost ⁽¹⁾	
Staffing Cost					
Utility Operator ⁽²⁾	3	\$/yr.	\$150,000		\$450,000
			Subtotal \$		450,000
Process Energy Costs ⁽³⁾					
UF	1.53	kW	\$ 0.35	\$	4,700
RO	1.86	kWh/kgal	\$ 0.35	\$	78,500
UVAOP	6.71	kW	\$ 0.35	\$	20,600
			Subtotal \$		103,800
Process Chemical Usage ⁽⁴⁾					
Sodium Hypochlorite (12.5 wt%)	43	lbs/d	\$ 2.12	\$	33,000
Sodium Hydroxide (50 wt%)	491	lbs/d	\$ 0.29	\$	52,000
Ammonium Sulfate (40 wt%)	2	lbs/d	\$ 0.45	\$	400
Sulfuric Acid (93 wt%)	428	lbs/d	\$ 0.29	\$	45,300
Antiscalant	17	lbs/d	\$ 5.22	\$	32,600
Citric Acid 50%	53	lbs/d	\$ 5.80	\$	112,100
Calcite	147	lbs/d	\$ 0.31	\$	16,700
			Subtotal \$		292,100
Process Consumables Costs					
UF Membrane Replacement ⁽⁵⁾	1	\$/yr.	\$ 14,800.00	\$	14,800
RO Membrane Replacement ⁽⁵⁾	1	\$/yr.	\$ 4,700.00	\$	4,700
UVAOP Lamp Replacement ⁽⁶⁾	1	\$/yr.	\$ 1,900.00	\$	1,900
			Subtotal \$		21,400
Additional Pumping ⁽⁷⁾					
Waste EQ	0.7	kW	\$ 0.35	\$	2,300
			Subtotal \$		2,300
TOTAL O&M COST				\$	869,600
Notes					
1. Expressed in 2023 dollars.					
2. IPR staffing based the City of Morro Bay 1 mgd IPR AWPf for 12 hours per day staffing. Costs assume a fully burdened rate of \$72/hour for staff.					
3. Process Energy Costs and Chemical Usage are Calculated Assuming Average (not peak) Flows					
4. Estimated from Projections and Material Balance					
5. Replacement of Duty Membranes Every 7 Years, Reported as Annualized Cost Based on a Sinking Fund Factor					
6. Replacement of Duty Lamps Every 2 Years, Reported as Annualized Costs Based on a Sinking Fund Factor					
7. Considers only Pumping Costs not Already Incorporated into Process Energy					

Buellton, DPR

STUDY TITLE:	Santa Barbara Countywide Potable Reuse Evaluation				
JOB NO.:	201798				
PROJECT:	Buellton				
ALTERNATIVE:	DPR - Infrastructure				
DESCRIPTION:	Level 5 Cost Estimate				
CAPITAL COST ESTIMATE					
Classification	Quantity	Units	Unit Cost	Estimated Cost⁽¹⁾	
Feedwater Piping					
WWTP Effluent to EQ Basin (12" Diameter)	250	LF	\$ 230	\$	58,000
EQ Basin to AWPFI Influent (6" Diameter)	350	LF	\$ 125	\$	44,000
			Subtotal	\$	102,000
Finished Water Piping					
6" Diameter, Developed	7,000	LF	\$ 160	\$	1,120,000
			Subtotal	\$	1,120,000
ROC Piping					
4" Diameter, Mostly Open	900	LF	\$ 90	\$	81,000
			Subtotal	\$	81,000
Waste/Backwash Return Piping					
6" Diameter, Mostly Open	500	LF	\$ 125	\$	63,000
			Subtotal	\$	63,000
Pump Station Cost					
Finished Water Pump Station	15	hp	\$ 25,000	\$	375,000
			Subtotal	\$	375,000
Pump Station Allowances					
Process Equipment Installation			25%	\$	94,000
Sitework			15%	\$	56,000
			Subtotal	\$	150,000
ROC Injection Wells					
Permitting	1	LS	\$ 150,000	\$	150,000
Injection Wells	2	ea	\$ 2,400,000	\$	4,800,000
Surface Facilities (tanks, pumps, piping, monitoring)	2	LS	\$ 500,000	\$	1,000,000
			Subtotal	\$	5,950,000
Total Direct Cost				\$	7,841,000
Estimating Contingency	30%			\$	2,352,000
Sales Tax (applied to 50% of direct costs) ⁽²⁾	7.75%			\$	304,000
Contractor Overhead & Profit	15%			\$	1,529,000
General Conditions	20%			\$	2,039,000
TOTAL CONSTRUCTION COST				\$	14,065,000
Engineering, Legal, and Administrative	12%			\$	1,688,000
Owners Reserve for Change Orders	5%			\$	703,000
TOTAL PROJECT COST				\$	16,460,000
Notes					
1. Expressed in 2023 dollars.					

Buellton, IPR

STUDY TITLE:	Santa Barbara Countywide Potable Reuse Evaluation				
JOB NO.:	201798				
PROJECT:	Buellton				
ALTERNATIVE:	IPR - Infrastructure, to 6 Month Injection Point				
DESCRIPTION:	Level 5 Cost Estimate				
CAPITAL COST ESTIMATE					
Classification	Quantity	Units	Unit Cost	Estimated Cost⁽¹⁾	
Feedwater Piping					
WWTP Effluent to EQ Basin (12" Diameter)	250	LF	\$ 230	\$	58,000
EQ Basin to AWPf Influent (6" Diameter)	350	LF	\$ 125	\$	44,000
			Subtotal	\$	102,000
Finished Water Piping					
6" Diameter, Developed	6,600	LF	\$ 160	\$	1,056,000
			Subtotal	\$	1,056,000
ROC Piping					
4" Diameter, Mostly Open	900	LF	\$ 90	\$	81,000
			Subtotal	\$	81,000
Waste/Backwash Return Piping					
6" Diameter, Mostly Open	500	LF	\$ 125	\$	63,000
			Subtotal	\$	63,000
Pump Station Cost					
Finished Water Pump Station	25	hp	\$ 25,000	\$	625,000
			Subtotal	\$	625,000
Pump Station Allowances					
Process Equipment Installation			25%	\$	156,000
Sitework			15%	\$	94,000
			Subtotal	\$	250,000
Finished Water Injection Wells					
Onsite Recycled Water Pump Station & Tank	1	LS	\$ 619,000	\$	619,000
Injection Sites - General Requiements and Site Civil	1	LS	\$ 779,300	\$	779,000
Injection Wells	1	LS	\$ 825,000	\$	825,000
Supporting EI&C	1	LS	\$ 213,800	\$	214,000
			Subtotal	\$	2,437,000
ROC Injection Wells					
Permitting	1	LS	\$ 150,000	\$	150,000
Injection Wells	2	ea	\$ 2,400,000	\$	4,800,000
Surface Facilities (tanks, pumps, piping, monitoring)	2	LS	\$ 500,000	\$	1,000,000
			Subtotal	\$	5,950,000
Total Direct Cost				\$	10,564,000

Buellton, IPR

STUDY TITLE:	Santa Barbara Countywide Potable Reuse Evaluation			
JOB NO.:	201798			
PROJECT:	Buellton			
ALTERNATIVE:	IPR - Infrastructure, to 6 Month Injection Point			
DESCRIPTION:	Level 5 Cost Estimate			
CAPITAL COST ESTIMATE				
Classification	Quantity	Units	Unit Cost	Estimated Cost⁽¹⁾
Estimating Contingency	30%		\$	3,169,000
Sales Tax (applied to 50% of direct costs) ⁽²⁾	7.75%		\$	409,000
Contractor Overhead & Profit	15%		\$	2,060,000
General Conditions	20%		\$	2,747,000
TOTAL CONSTRUCTION COST			\$	18,949,000
Engineering, Legal, and Administrative	12%		\$	2,274,000
Owners Reserve for Change Orders	5%		\$	947,000
TOTAL PROJECT COST			\$	22,170,000
Notes				
1. Expressed in 2023 dollars.				

Buellton, IPR

STUDY TITLE:	Santa Barbara Countywide Potable Reuse Evaluation				
JOB NO.:	201798				
PROJECT:	Buellton				
ALTERNATIVE:	IPR - Infrastructure, to 12 Month Injection Point				
DESCRIPTION:	Level 5 Cost Estimate				
CAPITAL COST ESTIMATE					
Classification	Quantity	Units	Unit Cost	Estimated Cost ⁽¹⁾	
Feedwater Piping					
WWTP Effluent to EQ Basin (12" Diameter)	250	LF	\$ 230	\$	58,000
EQ Basin to AWPf Influent (6" Diameter)	350	LF	\$ 125	\$	44,000
			Subtotal	\$	102,000
Finished Water Piping					
6" Diameter, Developed	11,500	LF	\$ 160	\$	1,840,000
			Subtotal	\$	1,840,000
ROC Piping					
4" Diameter, Mostly Open	900	LF	\$ 90	\$	81,000
			Subtotal	\$	81,000
Waste/Backwash Return Piping					
6" Diameter, Mostly Open	500	LF	\$ 125	\$	63,000
			Subtotal	\$	63,000
Pump Station Cost					
Finished Water Pump Station	25	hp	\$ 25,000	\$	625,000
			Subtotal	\$	625,000
Pump Station Allowances					
Process Equipment Installation			25%	\$	156,000
Sitework			15%	\$	94,000
			Subtotal	\$	250,000
Finished Water Injection Wells					
Onsite Recycled Water Pump Station & Tank	1	LS	\$ 619,000	\$	619,000
Injection Sites - General Requiements and Site Civil	1	LS	\$ 779,300	\$	779,000
Injection Wells	1	LS	\$ 825,000	\$	825,000
Supporting EI&C	1	LS	\$ 213,800	\$	214,000
			Subtotal	\$	2,437,000
ROC Injection Wells					
Permitting	1	LS	\$ 150,000	\$	150,000
Injection Wells	2	ea	\$ 2,400,000	\$	4,800,000
Surface Facilities (tanks, pumps, piping, monitoring)	2	LS	\$ 500,000	\$	1,000,000
			Subtotal	\$	5,950,000
Total Direct Cost				\$	11,348,000

Buellton, IPR

STUDY TITLE:	Santa Barbara Countywide Potable Reuse Evaluation			
JOB NO.:	201798			
PROJECT:	Buellton			
ALTERNATIVE:	IPR - Infrastructure, to 12 Month Injection Point			
DESCRIPTION:	Level 5 Cost Estimate			
CAPITAL COST ESTIMATE				
Classification	Quantity	Units	Unit Cost	Estimated Cost⁽¹⁾
Estimating Contingency	30%		\$	3,404,000
Sales Tax (applied to 50% of direct costs) ⁽²⁾	7.75%		\$	440,000
Contractor Overhead & Profit	15%		\$	2,213,000
General Conditions	20%		\$	2,950,000
TOTAL CONSTRUCTION COST			\$	20,355,000
Engineering, Legal, and Administrative	12%		\$	2,443,000
Owners Reserve for Change Orders	5%		\$	1,018,000
TOTAL PROJECT COST			\$	23,820,000
Notes	1. Expressed in 2023 dollars.			

Buellton

STUDY TITLE:		Santa Barbara Countywide Potable Reuse Evaluation						
JOB NO.:		201798						
PROJECT:		Buellton						
ALTERNATIVE:		IPR and DPR Infrastructure O&M Costs						
DESCRIPTION:		Level 5 Cost Estimate						
O&M Item	Quantity			Unit	Unit Cost	Annual Cost ⁽¹⁾		
	IPR, 6 Month	IPR, 12 Month	DPR			IPR, 6 Month	IPR, 12 Month	DPR
Power								
Feedwater PS	See footnote (2)			KW-hr/year	\$0.35			
Finished Water PS	163,374	163,374	98,024	KW-hr/year	\$0.35	\$58,000	\$58,000	\$35,000
ROC PS	See footnote (3)			KW-hr/year	\$0.35			
Annual Maintenance	See footnote (4)					\$111,000	\$119,000	\$82,000
TOTAL ESTIMATED ANNUAL O&M COSTS						\$169,000	\$177,000	\$117,000
<p>(1) Expressed in 2023 dollars.</p> <p>(2) Feedwater pumping not estimated at this level of detail. There will likely be a small pump station required to transport water from the WWTP to the AWPf that should be considered should this project move forward.</p> <p>(3) ROC pumping for the projects sited at Buellton was not estimated at this level of detail given that ROC can be injected adjacent to the Buellton WWTP. There will likely be a small pump station require to transport and inject ROC that should be considered should this project move forward.</p> <p>(4) Annual maintenance estimated as 0.5% of total capital costs.</p>								

Solvang/Buellton, DPR

PROJECT:	Santa Barbara Countywide Potable Reuse Evaluation				
JOB NO.:	201798				
ALTERNATIVE:	Solvang + Buellton				
COST:	DPR - Treatment Process Equipment and Building				
DESCRIPTION:	Level 5 Cost Estimate				
CAPITAL COST ESTIMATE					
Classification	Quantity	Units	Unit Cost	Estimated Cost ⁽¹⁾	
Equalization Tank					
Buellton EQ Tank ⁽²⁾	1	LS	\$ 318,000	\$	318,000
Solvang EQ Tank, 3.48 MG Below Grade Coated Concrete Tank ⁽³⁾	1	LS	\$ 25,997,000	\$	25,997,000
			Subtotal	\$	26,315,000
AWPF Building					
AWPF Building	27,876	ft ²	\$ 450	\$	12,545,000
Waste EQ Channel	1	LS	\$ 1,019,000	\$	1,019,000
			Subtotal	\$	13,564,000
Treatment Processes					
Ozone Generation and Injection	1	LS	\$ 2,900,000	\$	2,900,000
Biological Activated Carbon Filters	1	LS	\$ 1,120,000	\$	1,120,000
Ultrafiltration	1	LS	\$ 1,470,000	\$	1,470,000
Reverse Osmosis	1	LS	\$ 1,350,000	\$	1,350,000
UV Advanced Oxidation (LBX 850)	2	EA	\$ 118,500	\$	237,000
Secondary UV (Spektron 350)	2	EA	\$ 43,800	\$	88,000
Calcite Contactors	1	LS	\$ 520,000	\$	520,000
Water Quality/CCP Instrumentation	1	LS	\$ 170,000	\$	170,000
			Subtotal	\$	7,855,000
Chemical Dosing Equipment, Tanks and Pumps ⁽⁴⁾					
BAF Feed Pumps	25	hp	\$ 25,000	\$	625,000
BAF Backwash/MF Feed Tank	1	LS	\$ 101,000	\$	101,000
Sodium Hypochlorite Tank	1	LS	\$ 23,000	\$	23,000
Sodium Hypochlorite Dosing Pumps	8	pumps	\$ 11,000	\$	88,000
Sodium Hydroxide Tank	1	LS	\$ 160,000	\$	160,000
Sodium Hydroxide Dosing Pumps	4	pumps	\$ 11,000	\$	44,000
Sulfuric Acid Tank	1	LS	\$ 160,000	\$	160,000
Sulfuric Acid Dosing Pumps	4	pumps	\$ 11,000	\$	44,000
Tote System Pumps	12	pumps	\$ 11,000	\$	132,000
MF CIP Tank	1	LS	\$ 11,000	\$	11,000
MF Backwash/RO Feed Tank	1	LS	\$ 23,000	\$	23,000
Hot Water Tank	1	LS	\$ 11,000	\$	11,000
RO CIP Tank	1	LS	\$ 11,000	\$	11,000
RO Permeate Flush Tank	1	LS	\$ 9,000	\$	9,000
UVAOP Feed Tank	1	LS	\$ 9,000	\$	9,000
Chlorine Contact Tank	1	LS	\$ 46,000	\$	46,000
Blending Tank	1	LS	\$ 487,000	\$	487,000
Waste EQ Diversion Pumps	25	hp	\$ 25,000	\$	625,000
Waste EQ Pumps	2	hp	\$ 25,000	\$	50,000
			Subtotal	\$	2,659,000
Treatment Facility Items ⁽⁵⁾					
Process Equipment Installation			25%	\$	2,629,000
Piping and valves			20%	\$	2,103,000
			Subtotal	\$	4,732,000
Engineering Services					
Civil and Sitework			10%	\$	8,481,000
Electrical & I/C			25%	\$	21,202,000
			Subtotal	\$	29,683,000
Total Direct Cost				\$	84,808,000

Solvang/Buellton, DPR

PROJECT:	Santa Barbara Countywide Potable Reuse Evaluation			
JOB NO.:	201798			
ALTERNATIVE:	Solvang + Buellton			
COST:	DPR - Treatment Process Equipment and Building			
DESCRIPTION:	Level 5 Cost Estimate			
CAPITAL COST ESTIMATE				
Classification	Quantity	Units	Unit Cost	Estimated Cost⁽¹⁾
Estimating Contingency	30%		\$	25,443,000
Sales Tax (applied to 50% of direct costs)	7.75%		\$	3,287,000
Contractor Overhead & Profit	15%		\$	16,538,000
General Conditions	20%		\$	22,051,000
TOTAL CONSTRUCTION COST				\$ 152,127,000
Engineering, Legal, and Administrative	12%		\$	18,255,000
Owners Reserve for Change Orders	5%		\$	7,606,000
TOTAL PROJECT COST				\$ 177,990,000
Notes				
<ol style="list-style-type: none"> 1. Expressed in 2023 dollars. 2. Buellton EQ Tank: 13' tall, 48' diameter steel tank 3. Solvang EQ Tank: 240' x 160' x 15' Submerged Concrete Tank. The EQ tank could be removed or significantly reduced in size from this project if the peak wet weather flow does not have to be captured. This is pending discussions with the RWQCB. 4. Does not include pumps or equipment included in scope of supply for process (e.g. MF Feed Pumps) or infrastructure cost (finished water pumps, ROC pumps etc) 5. Treatment facility items are scaled as a factor of direct Treatment Processes and Chemical Dosing Equipment and Tanks, excluding building and other Engineering Services 				

Solvang/Buellton, DPR

PROJECT:	Santa Barbara Countywide Potable Reuse Evaluation
JOB NO.:	201798
ALTERNATIVE:	Solvang + Buellton
COST:	DPR - Treatment Process Opex
DESCRIPTION:	Level 5 Cost Estimate

O&M COST ESTIMATE					
Classification	Quantity	Units	Unit Cost	Annual Cost ⁽¹⁾	
Staffing Cost					
Utility Operator ⁽²⁾	6	\$/yr.	\$150,000		\$900,000
			Subtotal \$		900,000
Process Energy Costs⁽³⁾					
O3/BAF	57.1	kW	\$ 0.35	\$	175,000
UF	3.70	kW	\$ 0.35	\$	11,400
RO	1.77	kWh/kgal	\$ 0.35	\$	165,100
UVAOP	20.1	kW	\$ 0.35	\$	61,700
Secondary UV	2.1	kW	\$ 0.35	\$	6,300
			Subtotal \$		419,500
Process Chemical Usage⁽⁴⁾					
Sodium Hypochlorite (12.5 wt%)	79	lbs/d	\$ 2.12	\$	60,900
Sodium Hydroxide (50 wt%)	1116	lbs/d	\$ 0.29	\$	118,100
Ammonium Sulfate (40 wt%)	5	lbs/d	\$ 0.45	\$	800
Liquid Oxygen	170	lbs/d	\$ 0.09	\$	5,600
Sulfuric Acid (93 wt%)	949	lbs/d	\$ 0.29	\$	100,500
Antiscalant	38	lbs/d	\$ 5.22	\$	72,400
Citric Acid 50%	53	lbs/d	\$ 5.80	\$	112,100
Calcite	292	lbs/d	\$ 0.31	\$	33,100
			Subtotal \$		503,500
Process Consumables Costs					
UF Membrane Replacement ⁽⁵⁾	1	\$/yr.	\$ 16,300.00	\$	16,300
RO Membrane Replacement ⁽⁵⁾	1	\$/yr.	\$ 10,900.00	\$	10,900
UVAOP Lamp Replacement ⁽⁶⁾	1	\$/yr.	\$ 7,600.00	\$	7,600
Secondary UV Lamp Replacement ⁽⁶⁾	1	\$/yr.	\$ 800.00	\$	800
			Subtotal \$		35,600
Additional Pumping⁽⁷⁾					
Waste EQ	1.6	kW	\$ 0.35	\$	4,900
			Subtotal \$		4,900
TOTAL O&M COST				\$	1,863,500

Notes

- Expressed in 2023 dollars.
- DPR staffing based upon doubling the City of Morro Bay 1 mgd IPR AWPf for 12 hours per day staffing. Costs assume a fully burdened rate of \$72/hour for staff.
- Process Energy Costs and Chemical Usage are Calculated Assuming Average (not peak) Flows
- Estimated from Projections and Material Balance
- Replacement of Duty Membranes Every 7 Years, Reported as Annualized Cost Based on a Sinking Fund Factor
- Replacement of Duty Lamps Every 2 Years, Reported as Annualized Costs Based on a Sinking Fund Factor
- Considers only Pumping Costs not Already Incorporated into Process Energy

Solvang/Buellton, IPR

PROJECT:	Santa Barbara Countywide Potable Reuse Evaluation				
JOB NO.:	201798				
ALTERNATIVE:	Solvang + Buellton				
COST:	IPR - Treatment Process Equipment and Building				
DESCRIPTION:	Level 5 Cost Estimate				
CAPITAL COST ESTIMATE					
Classification	Quantity	Units	Unit Cost	Estimated Cost ⁽¹⁾	
Equalization Tank					
Buellton EQ Tank ⁽²⁾	1	LS	\$ 318,000	\$	318,000
Solvang EQ Tank, 3.48 MG Below Grade Coated Concrete Tank ⁽³⁾	1	LS	\$ 25,997,000	\$	25,997,000
			Subtotal	\$	26,315,000
AWPF Building					
AWPF Building	17,366	ft ²	\$ 450	\$	7,815,000
Waste EQ Channel	1	LS	\$ 549,000	\$	549,000
			Subtotal	\$	8,364,000
Treatment Processes					
Ultrafiltration	1	LS	\$ 1,830,000	\$	1,830,000
Reverse Osmosis	1	LS	\$ 1,360,000	\$	1,360,000
UV Advanced Oxidation (LBX 850)	2	EA	\$ 118,500	\$	237,000
Calcite Contactors	1	LS	\$ 520,000	\$	520,000
Water Quality/CCP Instrumentation	1	LS	\$ 112,500	\$	113,000
			Subtotal	\$	4,060,000
Chemical Dosing Equipment, Tanks and Pumps ⁽⁴⁾					
Sodium Hypochlorite Tank	1	LS	\$ 23,000	\$	23,000
Sodium Hypochlorite Dosing Pumps	8	pumps	\$ 11,000	\$	88,000
Sodium Hydroxide Tank	1	LS	\$ 160,000	\$	160,000
Sodium Hydroxide Dosing Pumps	4	pumps	\$ 11,000	\$	44,000
Sulfuric Acid Tank	1	LS	\$ 160,000	\$	160,000
Sulfuric Acid Dosing Pumps	4	pumps	\$ 11,000	\$	44,000
Tote System Pumps	12	pumps	\$ 11,000	\$	132,000
MF CIP Tank	1	LS	\$ 11,000	\$	11,000
MF Backwash/RO Feed Tank	1	LS	\$ 23,000	\$	23,000
Hot Water Tank	1	LS	\$ 11,000	\$	11,000
RO CIP Tank	1	LS	\$ 11,000	\$	11,000
RO Permeate Flush Tank	1	LS	\$ 9,000	\$	9,000
UVAOP Feed Tank	1	LS	\$ 9,000	\$	9,000
Chlorine Contact Tank	1	LS	\$ 46,000	\$	46,000
Waste EQ Diversion Pumps	25	hp	\$ 25,000	\$	625,000
Waste EQ Pumps	2	hp	\$ 25,000	\$	50,000
			Subtotal	\$	1,446,000
Treatment Facility Items ⁽⁵⁾					
Process Equipment Installation			25%	\$	1,377,000
Piping and valves			20%	\$	1,102,000
			Subtotal	\$	2,479,000
Engineering Services					
Civil and Sitework			10%	\$	6,564,000
Electrical & I/C			25%	\$	16,410,000
			Subtotal	\$	22,974,000
Total Direct Cost				\$	65,638,000

Solvang/Buellton, IPR

PROJECT:	Santa Barbara Countywide Potable Reuse Evaluation			
JOB NO.:	201798			
ALTERNATIVE:	Solvang + Buellton			
COST:	IPR - Treatment Process Equipment and Building			
DESCRIPTION:	Level 5 Cost Estimate			
CAPITAL COST ESTIMATE				
Classification	Quantity	Units	Unit Cost	Estimated Cost⁽¹⁾
Estimating Contingency	30%		\$	19,692,000
Sales Tax (applied to 50% of direct costs)	7.75%		\$	2,544,000
Contractor Overhead & Profit	15%		\$	12,800,000
General Conditions	20%		\$	17,066,000
TOTAL CONSTRUCTION COST			\$	117,740,000
Engineering, Legal, and Administrative	12%		\$	14,129,000
Owners Reserve for Change Orders	5%		\$	5,887,000
TOTAL PROJECT COST			\$	137,760,000
Notes				
<ol style="list-style-type: none"> 1. Expressed in 2023 dollars. 2. Buellton EQ Tank: 13' tall, 48' diameter steel tank 3. Solvang EQ Tank: 240' x 160' x 15' Submerged Concrete Tank. The EQ tank could be removed or significantly reduced in size from this project if the peak wet weather flow does not have to be captured. This is pending discussions with the RWQCB. 4. Does not include pumps or equipment included in scope of supply for process (e.g. MF Feed Pumps) or infrastructure cost (finished water pumps, ROC pumps etc) 5. Treatment facility items are scaled as a factor of direct Treatment Processes and Chemical Dosing Equipment and Tanks, excluding building and other Engineering Services 				

Solvang/Buellton, IPR

PROJECT:	Santa Barbara Countywide Potable Reuse Evaluation				
JOB NO.:	201798				
ALTERNATIVE:	Solvang + Buellton				
COST:	IPR - Treatment Process Opex				
DESCRIPTION:	Level 5 Cost Estimate				
O&M COST ESTIMATE					
Classification	Quantity	Units	Unit Cost	Annual Cost ⁽¹⁾	
Staffing Cost					
Utility Operator ⁽²⁾	3	\$/yr.	\$150,000		\$450,000
			Subtotal \$		450,000
Process Energy Costs ⁽³⁾					
UF	3.05	kW	\$ 0.35	\$	9,400
RO	1.88	kWh/kgal	\$ 0.35	\$	187,400
UVAOP	22.7	kW	\$ 0.35	\$	69,700
			Subtotal \$		266,500
Process Chemical Usage ⁽⁴⁾					
Sodium Hypochlorite (12.5 wt%)	84	lbs/d	\$ 2.12	\$	64,700
Sodium Hydroxide (50 wt%)	1192	lbs/d	\$ 0.29	\$	126,200
Ammonium Sulfate (40 wt%)	5	lbs/d	\$ 0.45	\$	900
Sulfuric Acid (93 wt%)	1012	lbs/d	\$ 0.29	\$	107,200
Antiscalant	40	lbs/d	\$ 5.22	\$	77,200
Citric Acid 50%	53	lbs/d	\$ 5.80	\$	112,100
Calcite	311	lbs/d	\$ 0.31	\$	35,200
			Subtotal \$		523,500
Process Consumables Costs					
UF Membrane Replacement ⁽⁵⁾	1	\$/yr.	\$ 35,500.00	\$	35,500
RO Membrane Replacement ⁽⁵⁾	1	\$/yr.	\$ 21,800.00	\$	21,800
UVAOP Lamp Replacement ⁽⁶⁾	1	\$/yr.	\$ 7,600.00	\$	7,600
			Subtotal \$		64,900
Additional Pumping ⁽⁷⁾					
Waste EQ	1.7	kW	\$ 0.35	\$	5,300
			Subtotal \$		5,300
TOTAL O&M COST				\$	1,310,200
Notes					
1. Expressed in 2023 dollars.					
2. IPR staffing based the City of Morro Bay 1 mgd IPR AWPf for 12 hours per day staffing. Costs assume a fully burdened rate of \$72/hour for staff.					
3. Process Energy Costs and Chemical Usage are Calculated Assuming Average (not peak) Flows					
4. Estimated from Projections and Material Balance					
5. Replacement of Duty Membranes Every 7 Years, Reported as Annualized Cost Based on a Sinking Fund Factor					
6. Replacement of Duty Lamps Every 2 Years, Reported as Annualized Costs Based on a Sinking Fund Factor					
7. Considers only Pumping Costs not Already Incorporated into Process Energy					

Solvang/Buellton, DPR

Santa Barbara Countywide Potable Reuse Evaluation					
JOB NO.:	201798				
PROJECT:	Solvang/Buellton Combined AWPf				
ALTERNATIVE:	DPR - Infrastructure				
DESCRIPTION:	Level 5 Cost Estimate				
CAPITAL COST ESTIMATE					
Classification	Quantity	Units	Unit Cost	Estimated Cost ⁽¹⁾	
Feedwater Piping					
Solvang, WWTP Effluent to EQ Basin (12" Diameter)	250	LF	\$ 230	\$	58,000
Solvang, EQ Basin to AWPf Influent (10" Diameter), Developed	19,125	LF	\$ 255	\$	4,877,000
Solvang, EQ Basin to AWPf Influent (10" Diameter), Trenchless River Crossing	1,200	LF	\$ 765	\$	918,000
Solvang, EQ Basin to AWPf Influent (10" Diameter), Trenchless Highway 101 Crossing	820	LF	\$ 765	\$	627,000
Buellton, WWTP Effluent to EQ Basin (12" Diameter)	250	LF	\$ 230	\$	58,000
Buellton, EQ Basin to AWPf Influent (6" Diameter)	350	LF	\$ 125	\$	44,000
			Subtotal	\$	6,582,000
Finished Water Piping					
Combined, 8" Diameter, Developed	4,900	LF	\$ 210	\$	1,029,000
Solvang, 6" Diameter, Developed	18,980	LF	\$ 160	\$	3,037,000
Solvang, 6" Diameter, Trenchless Highway 101 Crossing	820	LF	\$ 480	\$	394,000
Buellton, 6" Diameter, Developed	2,000	LF	\$ 160	\$	320,000
			Subtotal	\$	3,751,000
ROC Piping					
6" Diameter, Mostly Open	900	LF	\$ 125	\$	113,000
			Subtotal	\$	113,000
Waste/Backwash Return Piping					
8" Diameter, Mostly Open	500	LF	\$ 160	\$	80,000
			Subtotal	\$	80,000
Pump Station Cost					
Solvang to Buellton Feedwater Pump Station	25	hp	\$ 25,000	\$	625,000
Finished Water Pump Station	75	hp	\$ 21,500	\$	1,612,500
			Subtotal	\$	2,237,500
Pump Station Allowances					
Process Equipment Installation			25%	\$	559,000
Sitework			15%	\$	336,000
			Subtotal	\$	895,000
ROC Injection Wells (located at Buellton)					
Permitting	1	LS	\$ 150,000	\$	150,000
Injection Wells	2	ea	\$ 2,400,000	\$	4,800,000
Surface Facilities (tanks, pumps, piping, monitoring)	2	LS	\$ 500,000	\$	1,000,000
			Subtotal	\$	5,950,000
Total Direct Cost				\$	19,609,000

Solvang/Buellton, DPR

Santa Barbara Countywide Potable Reuse Evaluation					
JOB NO.:	201798				
PROJECT:	Solvang/Buellton Combined AWP				
ALTERNATIVE:	DPR - Infrastructure				
DESCRIPTION:	Level 5 Cost Estimate				
CAPITAL COST ESTIMATE					
	Classification	Quantity	Units	Unit Cost	Estimated Cost⁽¹⁾
	Estimating Contingency	30%		\$	5,883,000
	Sales Tax (applied to 50% of direct costs) ⁽²⁾	7.75%		\$	760,000
	Contractor Overhead & Profit	15%		\$	3,824,000
	General Conditions	20%		\$	5,098,000
	TOTAL CONSTRUCTION COST			\$	35,174,000
	Engineering, Legal, and Administrative	12%		\$	4,221,000
	Owners Reserve for Change Orders	5%		\$	1,759,000
	TOTAL PROJECT COST			\$	41,150,000
Notes					
1. Expressed in 2023 dollars.					
2. Tax rate assumes the City of Buellton 2023 tax rate. Should this combined project be pursued, the Solvang tax rate (8.75%) may need to be applied to portions of the infrastructure costs.					

Solvang/Buellton, IPR

STUDY TITLE: Santa Barbara Countywide Potable Reuse Evaluation					
JOB NO.: 201798					
PROJECT: Solvang/Buellton Combined AWPf					
ALTERNATIVE: IPR - Infrastructure, to 6 Month Injection Point					
DESCRIPTION: Level 5 Cost Estimate					
CAPITAL COST ESTIMATE					
Classification	Quantity	Units	Unit Cost	Estimated Cost ⁽¹⁾	
Feedwater Piping					
Solvang, WWTP Effluent to EQ Basin (12" Diameter)	250	LF	\$ 230	\$	58,000
Solvang, EQ Basin to AWPf Influent (10" Diameter), Developed	19,125	LF	\$ 255	\$	4,877,000
Solvang, EQ Basin to AWPf Influent (10" Diameter), Trenchless River Crossing	1,200	LF	\$ 765	\$	918,000
Solvang, EQ Basin to AWPf Influent (10" Diameter), Trenchless Highway 101 Crossing	820	LF	\$ 765	\$	627,000
Buellton, WWTP Effluent to EQ Basin (12" Diameter)	250	LF	\$ 230	\$	58,000
Buellton, EQ Basin to AWPf Influent (6" Diameter)	350	LF	\$ 125	\$	44,000
			Subtotal	\$	6,582,000
Finished Water Piping					
Combined, 8" Diameter, Developed	3,300	LF	\$ 210	\$	693,000
Solvang, 6" Diameter, Developed	16,780	LF	\$ 160	\$	2,685,000
Solvang, 6" Diameter, Trenchless Highway 101 Crossing	820	LF	\$ 480	\$	394,000
Buellton, 6" Diameter, Developed	6,600	LF	\$ 160	\$	1,056,000
			Subtotal	\$	4,135,000
ROC Piping					
6" Diameter, Mostly Open	900	LF	\$ 125	\$	113,000
			Subtotal	\$	113,000
Waste/Backwash Return Piping					
8" Diameter, Mostly Open	500	LF	\$ 160	\$	80,000
			Subtotal	\$	80,000
Pump Station Cost					
Solvang to Buellton Feedwater Pump Station	25	hp	\$ 25,000	\$	625,000
Finished Water Pump Station	100	hp	\$ 21,500	\$	2,150,000
			Subtotal	\$	2,775,000
Pump Station Allowances					
Process Equipment Installation			25%	\$	694,000
Sitework			15%	\$	416,000
			Subtotal	\$	1,110,000
Solvang Finished Water Injection Wells					
Onsite Recycled Water Pump Station & Tank	1	LS	\$ 1,313,000	\$	1,313,000
Injection Sites - General Requiements and Site Civil	1	LS	\$ 1,107,600	\$	1,108,000
Injection Wells	1	LS	\$ 2,475,000	\$	2,475,000
Supporting EI&C	1	LS	\$ 477,900	\$	478,000
			Subtotal	\$	5,374,000
Buellton Finished Water Injection Wells					
Onsite Recycled Water Pump Station & Tank	1	LS	\$ 619,000	\$	619,000
Injection Sites - General Requiements and Site Civil	1	LS	\$ 779,300	\$	779,000
Injection Wells	1	LS	\$ 825,000	\$	825,000
Supporting EI&C	1	LS	\$ 213,800	\$	214,000
			Subtotal	\$	2,437,000

Solvang/Buellton, IPR

STUDY TITLE:	Santa Barbara Countywide Potable Reuse Evaluation			
JOB NO.:	201798			
PROJECT:	Solvang/Buellton Combined AWWP			
ALTERNATIVE:	IPR - Infrastructure, to 6 Month Injection Point			
DESCRIPTION:	Level 5 Cost Estimate			
CAPITAL COST ESTIMATE				
Classification	Quantity	Units	Unit Cost	Estimated Cost⁽¹⁾
ROC Injection Wells (located at Buellton)				
Permitting	1	LS	\$ 150,000	\$ 150,000
Injection Wells	2	ea	\$ 2,400,000	\$ 4,800,000
Surface Facilities (tanks, pumps, piping, monitoring)	2	LS	\$ 500,000	\$ 1,000,000
			Subtotal	\$ 5,950,000
Total Direct Cost				\$ 28,556,000
Estimating Contingency	30%		\$	8,567,000
Sales Tax (applied to 50% of direct costs) ⁽²⁾	7.75%		\$	1,107,000
Contractor Overhead & Profit	15%		\$	5,568,000
General Conditions	20%		\$	7,425,000
TOTAL CONSTRUCTION COST				\$ 51,223,000
Engineering, Legal, and Administrative	12%		\$	6,147,000
Owners Reserve for Change Orders	5%		\$	2,561,000
TOTAL PROJECT COST				\$ 59,930,000
Notes				
1. Expressed in 2023 dollars.				
2. Tax rate assumes the City of Buellton 2023 tax rate. Should this combined project be pursued, the Solvang tax rate (8.75%) may need to be applied to portions of the infrastructure costs.				

Solvang/Buellton, IPR

STUDY TITLE: Santa Barbara Countywide Potable Reuse Evaluation						
JOB NO.: 201798						
PROJECT: Solvang/Buellton Combined AWWP						
ALTERNATIVE: IPR - Infrastructure, to 12 Month Injection Point						
DESCRIPTION: Level 5 Cost Estimate						
CAPITAL COST ESTIMATE						
Classification	Quantity	Units	Unit Cost	Estimated Cost ⁽¹⁾		
Feedwater Piping						
Solvang, WWTP Effluent to EQ Basin (12" Diameter)	250	LF	\$ 230	\$	58,000	
Solvang, EQ Basin to AWWP Influent (10" Diameter), Developed	19,125	LF	\$ 255	\$	4,877,000	
Solvang, EQ Basin to AWWP Influent (10" Diameter), Trenchless River Crossing	1,200	LF	\$ 765	\$	918,000	
Solvang, EQ Basin to AWWP Influent (10" Diameter), Trenchless Highway 101 Crossing	820	LF	\$ 765	\$	627,000	
Buellton, WWTP Effluent to EQ Basin (12" Diameter)	250	LF	\$ 230	\$	58,000	
Buellton, EQ Basin to AWWP Influent (6" Diameter)	350	LF	\$ 125	\$	44,000	
			Subtotal	\$	6,582,000	
Finished Water Piping						
Combined, 8" Diameter, Developed	3,300	LF	\$ 210	\$	693,000	
Solvang, 6" Diameter, Developed	21,080	LF	\$ 160	\$	3,373,000	
Solvang, 6" Diameter, Trenchless Highway 101 Crossing	820	LF	\$ 480	\$	394,000	
Buellton, 6" Diameter, Developed	8,100	LF	\$ 160	\$	1,296,000	
			Subtotal	\$	5,063,000	
ROC Piping						
6" Diameter, Mostly Open	900	LF	\$ 125	\$	113,000	
			Subtotal	\$	113,000	
Waste/Backwash Return Piping						
8" Diameter, Mostly Open	500	LF	\$ 160	\$	80,000	
			Subtotal	\$	80,000	
Pump Station Cost						
Solvang to Buellton Feedwater Pump Station	25	hp	\$ 25,000	\$	625,000	
Finished Water Pump Station	100	hp	\$ 21,500	\$	2,150,000	
			Subtotal	\$	2,775,000	
Pump Station Allowances						
Process Equipment Installation			25%	\$	694,000	
Sitework			15%	\$	416,000	
			Subtotal	\$	1,110,000	
Solvang Finished Water Injection Wells						
Onsite Recycled Water Pump Station & Tank	1	LS	\$ 1,313,000	\$	1,313,000	
Injection Sites - General Requiements and Site Civil	1	LS	\$ 1,107,600	\$	1,108,000	
Injection Wells	1	LS	\$ 2,475,000	\$	2,475,000	
Supporting EI&C	1	LS	\$ 477,900	\$	478,000	
			Subtotal	\$	5,374,000	
Buellton Finished Water Injection Wells						
Onsite Recycled Water Pump Station & Tank	1	LS	\$ 619,000	\$	619,000	
Injection Sites - General Requiements and Site Civil	1	LS	\$ 779,300	\$	779,000	
Injection Wells	1	LS	\$ 825,000	\$	825,000	
Supporting EI&C	1	LS	\$ 213,800	\$	214,000	
			Subtotal	\$	2,437,000	

Solvang/Buellton, IPR

STUDY TITLE:	Santa Barbara Countywide Potable Reuse Evaluation			
JOB NO.:	201798			
PROJECT:	Solvang/Buellton Combined AWPf			
ALTERNATIVE:	IPR - Infrastructure, to 12 Month Injection Point			
DESCRIPTION:	Level 5 Cost Estimate			
CAPITAL COST ESTIMATE				
Classification	Quantity	Units	Unit Cost	Estimated Cost⁽¹⁾
ROC Injection Wells (located at Buellton)				
Permitting	1	LS	\$ 150,000	\$ 150,000
Injection Wells	2	ea	\$ 2,400,000	\$ 4,800,000
Surface Facilities (tanks, pumps, piping, monitoring)	2	LS	\$ 500,000	\$ 1,000,000
			Subtotal	\$ 5,950,000
Total Direct Cost				\$ 29,484,000
Estimating Contingency	30%		\$	8,845,000
Sales Tax (applied to 50% of direct costs) ⁽²⁾	7.75%		\$	1,143,000
Contractor Overhead & Profit	15%		\$	5,749,000
General Conditions	20%		\$	7,666,000
TOTAL CONSTRUCTION COST				\$ 52,887,000
Engineering, Legal, and Administrative	12%		\$	6,346,000
Owners Reserve for Change Orders	5%		\$	2,644,000
TOTAL PROJECT COST				\$ 61,880,000
Notes				
1. Expressed in 2023 dollars.				
2. Tax rate assumes the City of Buellton 2023 tax rate. Should this combined project be pursued, the Solvang tax rate (8.75%) may need to be applied to portions of the infrastructure costs.				

Solvang/Buellton

STUDY TITLE:	Santa Barbara Countywide Potable Reuse Evaluation							
JOB NO.:	201798							
PROJECT:	Solvang/Buellton Combined							
ALTERNATIVE:	IPR and DPR Infrastructure O&M Costs							
DESCRIPTION:	Level 5 Cost Estimate							
O&M Item	Quantity			Unit	Unit Cost	Annual Cost ⁽¹⁾		
	IPR, 6 Month	IPR, 12 Month	DPR			IPR, 6 Month	IPR, 12 Month	DPR
Power								
Feedwater PS ⁽²⁾	163,374	163,374	163,374	KW-hr/year	\$0.35	\$58,000	\$58,000	\$58,000
Finished Water PS	653,496	653,496	490,122	KW-hr/year	\$0.35	\$229,000	\$229,000	\$172,000
ROC PS	See footnote (3)			KW-hr/year	\$0.35			
Annual Maintenance	See footnote (4)					\$300,000	\$309,000	\$206,000
TOTAL ESTIMATED ANNUAL O&M COSTS						\$587,000	\$596,000	\$436,000
<p>(1) Expressed in 2023 dollars.</p> <p>(2) Feedwater pumping shown is estimated for transport of water from the Solvang WWTP to the Buellton AWWP only. There will likely be a small pump station required to transport water from the Buellton WWTP to the AWWP that should be considered should this project move forward.</p> <p>(3) ROC pumping for the projects sited at Buellton was not estimated at this level of detail given that ROC can be injected adjacent to the Buellton WWTP. There will likely be a small pump station require to transport and inject ROC that should be considered should this project move forward.</p> <p>(4) Annual maintenance estimated as 0.5% of total capital costs.</p>								

Summerland Sanitary District

STUDY TITLE:	Santa Barbara Countywide Potable Reuse Evaluation
JOB NO.:	201798
PROJECT:	Summerland Sanitary District
ALTERNATIVE:	0.2 MGD Connection to Carpinteria Sanitary District
DESCRIPTION:	Level 5 Cost Estimate

CAPITAL COST ESTIMATE

Classification	Quantity	Units	Unit Cost	Estimated Cost ⁽¹⁾
New Pipe from SSD WWTP Site to CSD Collection System				
6" Diameter, Developed	15,780	LF	\$ 175	\$ 2,762,000
6" Diameter, Trenchless Hwy 101 and Railroad Crossing	320	LF	\$ 525	\$ 168,000
6" Diameter, Trenchless Creek Crossings (2 identified)	400	LF	\$ 525	\$ 210,000
			Subtotal	\$ 3,140,000
Upsized CSD Piping				
10" Upsized to 12" Piping	154	LF	\$ 226	\$ 35,000
14" Upsized to 16" Piping	139	LF	\$ 263	\$ 37,000
			Subtotal	\$ 72,000
Pump Station Cost				
SSD to CSD Connection Point Pump Station	5	hp	\$ 25,000	\$ 125,000
CSD Pump Station Upgrades	15	hp	\$ 25,000	\$ 375,000
			Subtotal	\$ 500,000
Pump Station Allowances				
Process Equipment Installation			25%	\$ 125,000
Sitework			15%	\$ 75,000
			Subtotal	\$ 200,000
470,000 gal Equalization Basin				
Staging	10	month	\$ 50,000	\$ 500,000
Utility Relocation	1	LS	\$ 500,000	\$ 500,000
Shoring	1	LS	\$ 2,000,000	\$ 2,000,000
Dewatering	10	month	\$ 5,000	\$ 50,000
Excavation	2,400	CY	\$ 50	\$ 120,000
Tank Construction	470,000	gal	\$ 2.50	\$ 1,175,000
			Subtotal	\$ 4,345,000
Odor Control System				
8-ft Diameter Carbon Adsorber	1	LS	\$ 250,000	\$ 250,000
			Subtotal	\$ 250,000
Odor Control Allowances				
Process Equipment Installation			25%	\$ 63,000
Sitework			15%	\$ 38,000
Electrical & I/C			25%	\$ 63,000
			Subtotal	\$ 164,000
Screenings Facility				
Screenings and Conveyor Facility	1	LS	\$ 800,000	\$ 800,000
			Subtotal	\$ 800,000
Total Direct Cost				\$ 9,471,000

Summerland Sanitary District

STUDY TITLE:	Santa Barbara Countywide Potable Reuse Evaluation			
JOB NO.:	201798			
PROJECT:	Summerland Sanitary District			
ALTERNATIVE:	0.2 MGD Connection to Carpinteria Sanitary District			
DESCRIPTION:	Level 5 Cost Estimate			
CAPITAL COST ESTIMATE				
Classification	Quantity	Units	Unit Cost	Estimated Cost⁽¹⁾
Estimating Contingency	30%		\$	2,841,000
Sales Tax (applied to 50% of direct costs) ⁽²⁾	7.75%		\$	367,000
Contractor Overhead & Profit	15%		\$	1,847,000
General Conditions	20%		\$	2,462,000
TOTAL CONSTRUCTION COST			\$	16,988,000
Engineering, Legal, and Administrative	12%		\$	2,039,000
Owners Reserve for Change Orders	5%		\$	849,000
TOTAL PROJECT COST			\$	19,880,000
Notes				
1. Expressed in 2023 dollars.				

Summerland Sanitary District

STUDY TITLE:	Santa Barbara Countywide Potable Reuse Evaluation
JOB NO.:	201798
PROJECT:	Summerland Sanitary District
ALTERNATIVE:	0.2 MGD Connection to Carpinteria Sanitary District
DESCRIPTION:	Level 5 Cost Estimate

CAPITAL COST ESTIMATE						
Classification	Quantity	Units	Unit Cost		Estimated Cost ¹⁾	
New Pipe from SSD WWTP Site to CSD Collection System						
6" Diameter, Developed	21,060	LF	\$	175	\$	3,686,000
6" Diameter, Trenchless Hwy 101 and Railroad Crossing	320	LF	\$	525	\$	168,000
6" Diameter, Trenchless Hwy 101 Crossing	820	LF	\$	525	\$	431,000
6" Diameter, Trenchless Creek Crossings (2 identified)	400	LF	\$	525	\$	210,000
				Subtotal	\$	4,495,000
Upsized CSD Piping						
12" Upsized to 14" Piping	194	LF	\$	244	\$	47,000
14" Upsized to 18" Piping	139	LF	\$	285	\$	40,000
15" Upsized to 16" Piping	593	LF	\$	263	\$	156,000
21" Upsized to 24" Piping	159	LF	\$	401	\$	64,000
				Subtotal	\$	307,000
Pump Station Cost						
SSD to CSD Connection Point Pump Station	40	hp	\$	21,500	\$	860,000
CSD Pump Station Upgrades	20	hp	\$	25,000	\$	500,000
				Subtotal	\$	1,360,000
Pump Station Allowances						
Process Equipment Installation				25%	\$	340,000
Sitework				15%	\$	204,000
				Subtotal	\$	544,000
Existing 70,000 Gallon Equalization Basin Rehabilitation						
Concrete Repair	1	LS	\$	160,000	\$	160,000
Basin Coating	1	LS	\$	50,000	\$	50,000
				Subtotal	\$	210,000
Odor Control System						
8-ft Diameter Carbon Adsorber	1	LS	\$	180,000	\$	180,000
				Subtotal	\$	180,000
Odor Control Allowances						
Process Equipment Installation				25%	\$	45,000
Sitework				15%	\$	27,000
Electrical & I/C				25%	\$	45,000
				Subtotal	\$	117,000
Screenings Facility						
Screenings and Conveyor Facility	1	LS	\$	800,000	\$	800,000
				Subtotal	\$	800,000
Total Direct Cost					\$	8,013,000

Summerland Sanitary District

STUDY TITLE:	Santa Barbara Countywide Potable Reuse Evaluation			
JOB NO.:	201798			
PROJECT:	Summerland Sanitary District			
ALTERNATIVE:	0.2 MGD Connection to Carpinteria Sanitary District			
DESCRIPTION:	Level 5 Cost Estimate			
CAPITAL COST ESTIMATE				
Classification	Quantity	Units	Unit Cost	Estimated Cost⁽¹⁾
Estimating Contingency	30%		\$	2,404,000
Sales Tax (applied to 50% of direct costs) ⁽²⁾	7.75%		\$	311,000
Contractor Overhead & Profit	15%		\$	1,563,000
General Conditions	20%		\$	2,083,000
TOTAL CONSTRUCTION COST			\$	14,374,000
Engineering, Legal, and Administrative	12%		\$	1,725,000
Owners Reserve for Change Orders	5%		\$	719,000
TOTAL PROJECT COST			\$	16,820,000
Notes				
1. Expressed in 2023 dollars.				

Summerland Sanitary District

STUDY TITLE:	Santa Barbara Countywide Potable Reuse Evaluation					
JOB NO.:	201798					
PROJECT:	Solvang					
ALTERNATIVE:	IPR and DPR Infrastructure O&M Costs					
DESCRIPTION:	Level 5 Cost Estimate					
O&M Item	Quantity		Unit	Unit Cost	Annual Cost ⁽¹⁾	
	0.2 mgd Flow	0.47 mgd Flow			0.2 mgd Flow	0.47 mgd Flow
Power						
SSD to CSD Connection Point PS	32,675	261,398	KW-hr/year	\$0.35	\$12,000	\$92,000
CSD PS Upgrades	98,024	130,699	KW-hr/year	\$0.35	\$35,000	\$46,000
Odor Control System	65,350	32,675	KW-hr/year	\$0.35	\$23,000	\$12,000
Screenings and Conveyor Facility	6,535	6,535	KW-hr/year	\$0.35	\$3,000	\$3,000
Annual Maintenance	See footnote (2)				\$99,000	\$84,000
Odor Control Media Replacement	See footnote (3)				\$5,000	\$1,000
TOTAL ESTIMATED ANNUAL O&M COSTS					\$177,000	\$238,000
<p>(1) Expressed in 2023 dollars.</p> <p>(2) Annual maintenance estimated as 0.5% of total capital costs.</p> <p>(3) Odor control media assumed to be the high capacity, Jacobi OX30, 4mm diameter. Media replacment required approximately every 3.5 years.</p>						