

**ATTACHMENT K: MONTECITO PLANNING COMMISSION ACTION  
LETTER AND RESOLUTIONS, DATED SEPTEMBER 18, 2024**



# County of Santa Barbara Planning and Development

Lisa Plowman, Director

Jeff Wilson, Assistant Director

Elise Dale, Assistant Director

TO THE HONORABLE BOARD OF SUPERVISORS  
COUNTY OF SANTA BARBARA, CALIFORNIA

MONTECITO PLANNING COMMISSION  
HEARING OF SEPTEMBER 18, 2024

**RE: *Outdoor Lighting, Signs, and Miscellaneous Ordinance Amendments; 24ORD-00002, 24ORD-00003***

Hearing on the request of the Planning and Development Department that the Montecito Planning Commission consider the following:

- Case No. 24ORD-00002: an Ordinance Amendment to the Montecito Land Use and Development Code (MLUDC) to include new and revised regulations regarding outdoor lighting, to include new and revised regulations regarding the placement and types of allowable signs within the Montecito Community Plan Area, and to make other minor, miscellaneous changes.
- Case No. 24ORD-00003: an Ordinance Amendment to the Article II – Coastal Zoning Ordinance (CZO) to include new and revised regulations regarding outdoor lighting, to include new and revised regulations regarding the placement and types of allowable signs within the Coastal Zone, to make other minor, miscellaneous changes, and to repeal Article I – Sign Regulations or Chapter 35 – Zoning, of the County Code.
- Changes to the *Montecito Architectural Guidelines and Development Standards*. (Continued from 08/21/24)

---

Dear Honorable Members of the Board of Supervisors:

At the Montecito Planning Commission hearing of September 18, 2024, Commissioner Stahl moved, seconded by Commissioner Senauer and carried by a vote of 4 to 0 (Kupiec absent) to:

**Case No. 24ORD-00002**

1. Make the required findings for approval, including CEQA findings, and recommend that the Board make the required findings for approval, including CEQA findings, of the proposed amendment, Case No. 24ORD-00002 (Attachment A of the staff memorandum dated September 10, 2024);

2. Recommend that the Board determine that this ordinance is exempt from environmental review pursuant to State CEQA Guidelines Section 15061(b)(3) (Attachment B of the staff memorandum dated September 10, 2024); and
3. Adopt a resolution (Attachment C of the staff memorandum dated September 10, 2024) recommending that the Board approve Case No. 24ORD-00002, an ordinance amending the Montecito Land Use and Development Code with new and revised regulations for outdoor lighting, signs, and other miscellaneous sections, with the revisions recommended by the Montecito Planning Commission at the September 18, 2024, hearing.

### **Case No. 24ORD-00003**

1. Recommend that the County Planning Commission make the required findings for approval, including California Environmental Quality Act (CEQA) findings, and recommend that the Board make the required findings for approval, including CEQA findings, of the proposed amendment, Case No. 24ORD-00003 (Attachment A of the of the staff memorandum dated September 10, 2024);
2. Recommend that the County Planning Commission recommend that the Board determine this ordinance is exempt from environmental review pursuant to State CEQA Guidelines Sections 15061(b)(3) and 15265 (Attachment B of the staff memorandum dated September 10, 2024); and
3. Adopt a resolution (Attachment D of the staff memorandum dated September 10, 2024) recommending that the County Planning Commission recommend that the Board approve Case No. 24ORD-00003, an ordinance amending Article II – Coastal Zoning Ordinance with new and revised regulations for outdoor lighting, signs, and other miscellaneous sections, with the revisions recommended by the Montecito Planning Commission at the September 18, 2024, hearing, and to repeal Article I – Sign Regulations or Chapter 35 – Zoning, of the Santa Barbara County Code.

### **Montecito Architectural Guidelines and Development Standards Amendment**

1. Recommend that the Board determine that the Montecito Architectural Guidelines and Development Standards amendment is exempt from environmental review pursuant to State CEQA Guidelines Section 15061(b)(3) (Attachment B of the of the staff memorandum dated September 10, 2024); and
2. Adopt a resolution (Attachment E of the staff memorandum dated September 10, 2024) recommending that the Board of Supervisors revise the *Montecito Architectural Guidelines and Development Standards* for consistency with the adoption of the Outdoor Lighting, Signs, and Miscellaneous Ordinance Amendments, Case Nos. 24ORD-00002 and 24ORD-00003, to the MLUDC and CZO.

### ***RECOMMENDED REVISIONS***

As part of its recommendations to the County Planning Commission and Board of Supervisors, the Montecito Planning Commission made the following revisions at the September 18, 2024, hearing, and said revisions are incorporated in Attachment C, MLUDC Resolution and Ordinance, and Attachment D, CZO Resolution and Ordinance.

1. Allow for uplighting of specimen trees and the U.S. flag with a cumulative limit of 500 lumens;

2. Require that string lights installed outside of landscaping be hooded;
3. Clarify that the 60-day limit for seasonal lighting be usage of lights, not placement; and
4. Require that lights shall not be directed towards the ocean.

Sincerely,

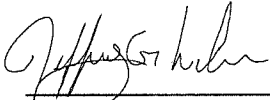

---

Jeff Wilson  
Secretary Planning Commission

cc: Case File: 24ORD-00002, 24ORD-00003  
Jeff Wilson, Assistant Director  
Alex Tuttle Deputy Director, Long Range Planning  
Ben Singer, Planner

**Attachments:**            **Attachment A – Findings**  
                                 **Attachment C – MLUDC Resolution and Ordinance**  
                                 **Attachment D – CZO Resolution and Ordinance**  
                                 **Attachment E – Montecito Architectural Guidelines and Development**  
                                 **Standards Resolution**

JW/dmv

G:\GROUP\COMP\Ordinances\Outdoor Lighting and Signs\Public Hearings\MPC\09-18-24actltr.doc

**ATTACHMENT A: FINDINGS OF APPROVAL**

**1.0 CEQA FINDINGS**

**1.1 CEQA EXEMPTION**

**Case No. 24ORD-00002:** The Montecito Planning Commission finds and recommends that the Board of Supervisors find that the proposed ordinance amendments are exempt from environmental review under the California Environmental Quality Act (CEQA) pursuant to CEQA Guidelines Section 15061(b)(3). Please see Attachment C, Notice of Exemption, incorporated herein by reference.

**Case No. 24ORD-00003:** The Montecito Planning Commission finds and recommends that the County Planning Commission recommend that the Board of Supervisors find that the proposed ordinance amendments are exempt from environmental review under CEQA pursuant to CEQA Guidelines Sections 15061(b)(3) and 15265. Please see Attachment C, Notice of Exemption, incorporated herein by reference.

**Montecito Architectural Guidelines and Development Standards:** The Montecito Planning Commission finds and recommends that the Board of Supervisors find that the proposed guidelines amendments are exempt from environmental review under CEQA pursuant to CEQA Guidelines Sections 15061(b)(3) and 15265. Please see Attachment C, Notice of Exemption, incorporated herein by reference.

**2.0 ADMINISTRATIVE FINDINGS**

**ARTICLE II COASTAL ZONING ORDINANCE AND MONTECITO LAND USE AND DEVELOPMENT CODE FINDINGS**

**Findings required for approval or conditional approval of an Ordinance Amendment.** In compliance with Section 35-180.6 of the Article II Coastal Zoning Ordinance and Section 35.494.060 of the Montecito Land Use and Development Code (MLUDC), prior to the approval or conditional approval of an application for a Zoning Ordinance (CZO) amendment, the decision-maker shall first make all of the following findings:

**2.1 The request is in the interests of the general community welfare.**

The Montecito Planning Commission finds and recommends that the Board find that the proposed ordinance amendments are in the interests of the general community welfare. The proposed amendments will provide new and revised regulations on outdoor lighting and signs in the inland and coastal portions of the Montecito Community Plan Area, in addition to making miscellaneous changes to the MLUDC and CZO to clarify and modernize requirements regarding setbacks, pool cabañas, and short-term rental enforcement. These regulations will provide for orderly development within the Montecito Community Plan Area, reduce light trespass and light pollution, clarify requirements for signs and outdoor lighting, and make other portions of the MLUDC and CZO clearer and easier to interpret, apply, and enforce.

**2.2 The request is consistent with the Comprehensive Plan, the Coastal Land Use Plan, the requirements of the State planning and zoning laws, and this Article and Development Code.**

The Montecito Planning Commission finds and recommends that the Board find that the proposed ordinance amendments are consistent with the County Comprehensive Plan, including the Coastal Land Use Plan and Montecito Community Plan, the requirements of the State planning and zoning laws, and the CZO and MLUDC. The proposed amendments will update and standardize regulations regarding signs and outdoor lighting for consistency, and update and modernize other miscellaneous sections of the CZO and MLUDC as discussed in Finding 2.1 above. The proposed ordinance amendments do not conflict with any goals or policies of the County Comprehensive Plan or Coastal Land Use Plan.

**2.3 The request is consistent with good zoning and planning practices.**

The Montecito Planning Commission finds and recommends that the Board find that the proposed ordinance amendments are consistent with good zoning and planning practices. The proposed amendments will provide for orderly development of signs and lighting within the Montecito Community Plan Area, in addition to updating and modernizing miscellaneous portions of the MLUDC and CZO as discussed in Finding 2.1 above. The proposed amendments will protect against light trespass and light pollution, and standardize, consolidate, and clarify the regulations regarding signs and outdoor lighting. The amendments will be applied county-wide, providing a basic standard across the entire County, while still maintaining some community-specific requirements to ensure that community character is not impacted.

ATTACHMENT C: 24ORD-00002 RESOLUTION

RESOLUTION OF THE MONTECITO PLANNING COMMISSION  
COUNTY OF SANTA BARBARA, STATE OF CALIFORNIA

IN THE MATTER OF RECOMMENDING THAT THE )  
BOARD OF SUPERVISORS ADOPT AN ORDINANCE )  
AMENDING SECTION 35-2, THE SANTA BARBARA )  
COUNTY MONTECITO LAND USE AND )  
DEVELOPMENT CODE, OF CHAPTER 35, ZONING, )  
OF THE COUNTY CODE BY AMENDING DIVISION )  
35.2, MONTECITO ZONES AND ALLOWABLE LAND )  
USES; DIVISION 35.3, MONTECITO SITE PLANNING )  
AND OTHER PROJECT STANDARDS; DIVISION 35.4, )  
MONTECITO STANDARDS FOR SPECIFIC LAND )  
USES; DIVISION 35.7, MONTECITO PLANNING )  
PERMIT PROCEDURES; DIVISION 35.9, MONTECITO )  
LAND USE AND DEVELOPMENT CODE )  
ADMINISTRATION; AND DIVISION 35.10, )  
GLOSSARY, TO IMPLEMENT NEW REGULATIONS )  
AND DEVELOPMENT STANDARDS REGARDING )  
OUTDOOR LIGHTING, SIGNS, AND SIGN )  
STRUCTURES, AND MAKE OTHER MISCELLANEOUS )  
CHANGES. )

RESOLUTION NO.: 24- 10

CASE NO.: 24ORD-00002

**WHEREAS**, on November 27, 2007, by Ordinance 4660, the Board of Supervisors (Board) adopted the Santa Barbara County Montecito Land Use and Development Code (MLUDC), Section 35-2 of Chapter 35 of the Santa Barbara County Code; and

**WHEREAS**, the MLUDC contains many regulations and standards, and periodic updates are needed to clarify and modernize portions of the code; and

**WHEREAS**, the Montecito Planning Commission now finds that it is in the interest of the orderly development of the County and important to the preservation of health, safety, and general welfare of the residents of the County, to recommend that the Board adopt an ordinance (Case No. 24ORD-00002) amending Division 35.2, Montecito Zones and Allowable Land Uses; Division 35.3, Montecito Site Planning and Other Project Standards; Division 35.4, Montecito Standards for Specific Land Uses; Division 35.7, Montecito Planning Permit Procedures; Division 35.9, Montecito Land Use and Development Code Administration; and Division 35.10, Glossary; of Section 35-2, the MLUDC, of Chapter 35, Zoning, of the Santa Barbara County Code to implement new regulations regarding outdoor lighting and signs and make other miscellaneous changes regarding setbacks, pool cabañas, and short-term rental enforcement; and

**WHEREAS**, the proposed MLUDC amendment is attached hereto as Attachment C-1 and is incorporated herein by reference; and

**WHEREAS**, the proposed MLUDC amendment is consistent with the County Comprehensive Plan, including the Montecito Community Plan, and the requirements of State planning, zoning, and development laws; and

**WHEREAS**, the proposed MLUDC amendment is in the interest of the general community welfare since it will provide for orderly development within the Montecito Community Plan Area, reduce light trespass

and light pollution, and clarify requirements for signs, outdoor lighting, and other sections of the MLUDC; and

WHEREAS, the Montecito Planning Commission has held duly noticed public hearings on August 21, 2024, and September 18, 2024, in compliance with Government Code Section 65854, on the proposed Montecito Land Use and Development Code amendment, at which hearing the proposed amendments were explained and comments invited from the persons in attendance.

NOW, THEREFORE, IT IS HEREBY RESOLVED as follows:

1. The above recitations are true and correct.
2. In compliance with the provisions of Government Code Section 65855, the Montecito Planning Commission recommends that the Board of Supervisors of the County of Santa Barbara, State of California, following the required noticed public hearing, approve and adopt the above-mentioned recommendation of this Montecito Planning Commission, based on the findings included as Attachment A of the Montecito Planning Commission staff memorandum dated September 10, 2024, and with the following revisions recommended by the Montecito Planning Commission at the September 18, 2024, hearing:
  - a. Allow for uplighting of specimen trees and the U.S. flag with a cumulative limit of 500 lumens;
  - b. Require that string lights installed outside of landscaping be hooded;
  - c. Clarify that the 60-day limit for seasonal lighting shall be usage of the lights, not placement; and
  - d. Require that lights shall not be directed towards the ocean.
3. A certified copy of this Resolution shall be transmitted to the Board in compliance with Government Code Section 65855.
4. The Chair of the Montecito Planning Commission is hereby authorized and directed to sign and certify all documents and other materials in accordance with this Resolution to reflect the above mentioned action by the Montecito Planning Commission.

PASSED, APPROVED, AND ADOPTED this 18<sup>th</sup> day of September, 2024 by the following vote:

AYES: Miller, Senauer, Pulice, Stahl

NOES:

ABSENT: Kupiec

ABSTENTIONS:

  
MARSHALL MILLER, CHAIR



Outdoor Lighting, Signs, and Miscellaneous Ordinance Amendments  
Montecito Planning Commission  
Hearing Date: September 18, 2024  
Attachment C – Page 3

SANTA BARBARA COUNTY  
MONTECITO PLANNING COMMISSION

ATTEST:

JEFF WILSON  
SECRETARY TO THE COMMISSION

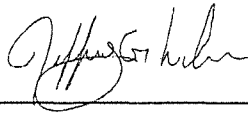
By   
\_\_\_\_\_

APPROVED AS TO FORM:

RACHEL VAN MULLEM  
COUNTY COUNSEL

By   
\_\_\_\_\_ DEPUTY COUNTY COUNSEL

Attachment C-1: Montecito Land Use and Development Code Ordinance Amendment, Case No.  
24ORD-00002

**ATTACHMENT C-1: MONTECITO LAND USE AND DEVELOPMENT CODE  
ORDINANCE AMENDMENT**

**ORDINANCE NO. \_\_\_\_\_**

AN ORDINANCE AMENDING SECTION 35-2, THE SANTA BARBARA COUNTY MONTECITO LAND USE AND DEVELOPMENT CODE (MLUDC), CHAPTER 35, OF THE COUNTY CODE, BY AMENDING DIVISION 35.2, MONTECITO ZONES AND ALLOWABLE LAND USES; DIVISION 35.3, MONTECITO SITE PLANNING AND OTHER PROJECT STANDARDS; DIVISION 35.4, MONTECITO STANDARDS FOR SPECIFIC LAND USES; DIVISION 35.7, MONTECITO PLANNING PERMIT PROCEDURES; DIVISION 35.9, MONTECITO LAND USE AND DEVELOPMENT CODE ADMINISTRATION; AND DIVISION 35.10, GLOSSARY, TO IMPLEMENT NEW REGULATIONS AND DEVELOPMENT STANDARDS REGARDING OUTDOOR LIGHTING, SIGNS, AND SIGN STRUCTURES, AND MAKE OTHER MISCELLANEOUS CHANGES.

Case No. 24ORD-00002

The Board of Supervisors of the County of Santa Barbara, State of California, ordains as follows:

**SECTION 1:**

DIVISION 35.2, Montecito Zones and Allowable Land Uses, of Section 35-2, the Montecito Land Use and Development Code, of Chapter 35, Zoning, of the Santa Barbara County Code, Subsection 20, Signs, flags, and similar devices, of Subsection B, Exempt activities and structures, of Section 35.420.040, Exemptions from Planning Permit Requirements, of Chapter 35.420, Development and Land Use Approval Requirements, is hereby amended to read as follows:

**20. Signs, flags, and similar devices.** Signs, ~~flags and similar devices~~ in compliance with Section 35.438.030 (~~Exemptions Exempt Signs, Flags, and Devices~~).

**SECTION 2:**

DIVISION 35.3, Montecito Site Planning and Other Project Standards, of Section 35-2, the Montecito Land Use and Development Code, of Chapter 35, Zoning, of the Santa Barbara County Code, Section 35.430.120, Outdoor Lighting, of Chapter 35.430, Standards for All Development and Land Uses, is hereby amended to read as follows:

- ~~A. All exterior lighting shall be hooded and no unobstructed beam of exterior light shall be directed toward any area zoned or developed residential.~~
- ~~B. Lighting shall be designed so as not to interfere with vehicular traffic on any portion of a street.~~
- A. Purpose.** The purpose of this Section is to create standards for outdoor lighting that minimize light pollution caused by inappropriate or misaligned light fixtures. These standards conserve

energy and preserve the nighttime sky while maintaining nighttime safety, utility, security and productivity. The County recognizes that the unique development patterns and environments of the County created ideal areas for astronomical observation and enjoyment of the nighttime sky. Additionally, resources in the County warrant the protection of nighttime viewsheds and wildlife corridors from light trespass. The County, through the provisions contained herein, intends to preserve and protect the nighttime environment of the County by regulating unnecessary and excessive outdoor lighting. See “Lighting” within Division 35.10 (Glossary) for definitions related to outdoor lighting used within this Section.

**B. Applicability.** The standards of this Section apply to all new or replaced outdoor light fixtures or systems and to existing lighting, as provided below unless specifically exempted or required pursuant to any other applicable code or regulation.

**1. Existing Lighting.** All outdoor lighting fixtures lawfully installed prior to the effective date of this Section are subject to only Subsections E.4 (Glare Prevention) and E.7 (Timing Controls) of this Section.

**2. New and Replaced Lighting.** The standards of this Section apply to all new or replaced outdoor light fixtures or systems, except as specifically exempted pursuant to Subsection B.4 (Exemptions) below.

**3. Additions and Remodels.** Additions totaling 50 percent or more of the existing gross floor area of a structure or exterior alterations affecting 50 percent or more of a building’s exterior shall require that all existing lighting on the lot be brought into compliance with the provisions of this Section.

**4. Exemptions.** The following types of lighting are exempt from the provisions of this Section.

a. Fossil fuel lights.

b. Traffic control signs and devices.

c. Street lights installed prior to the effective date of the Ordinance adding this section.

d. Temporary construction or emergency lighting under direction of a public agency (e.g., fire, police, public works).

e. Navigation lights (e.g., airports, heliports, radio/television towers).

f. Seasonal lighting decorations in place no longer than 60 days per calendar year.

g. Light fixtures with a maximum output of 60 lumens, including solar lights.

h. Underwater lights used to illuminate swimming pools, spas, fountains, and other water features.

i. Temporary lighting for agricultural activities of a limited duration, not including unshielded arena lights.

**5. Alternative Compliance.** The provisions of this Section are not intended to prevent the use of any design, material or method of installation not specifically prescribed by this Section provided any such alternate has been approved by the Director as part of a planning permit. The Director may approve any such alternate provided that the proposed design, material or method:

- a. Provides approximate equivalence to the specific requirements of this Section; and
- b. Is otherwise satisfactory and complies with the purpose of this Section.

**C. Prohibited Lights and Lighting.** The following lights and lighting are prohibited:

1. Search lights, strobe lights, laser source lights, or similar high intensity lights except as specifically exempted or for the purposes of gathering meteorological data.
2. Mercury vapor lights.
3. Uplighting.

~~C.~~**4.** Recreational court lighting is prohibited in all residential zones.

**D. Maximum Light Levels.** Outdoor lighting shall comply with the following maximum light levels except where otherwise allowed through the approval of the Conditional Use Permit or Development Plan, as applicable.

**1. Light Levels Within Designated Environmentally Sensitive Habitat Areas and Buffer Areas.**

- a. Environmentally Sensitive Habitat Areas shall not be illuminated, including illumination of the Environmentally Sensitive Habitat area from a light source located outside of the Environmentally Sensitive Habitat area.
- b. The maximum lighting level within designated Environmentally Sensitive Habitat areas shall not exceed 0.0 foot-candles.
- c. No light fixture located within an Environmentally Sensitive Habitat buffer area shall exceed 630 lumens.

**2. Light Levels at Property Lines.** The light level at property lines shall not exceed 0.1 foot-candles, except as provided below.

a. **Multi-family Zoned Property Abutting or Within a Multi-family, Commercial, or Industrial Zone.** Where a property is located within a Multi-family Zone and the neighboring property is located within a Multi-family, Commercial, or Industrial Zone, the maximum lighting level at the shared property line shall be 0.2 foot-candles.

**b. Commercial and Industrial Zoned Property.**

**(1) Abutting a Multi-family Zone.** Where a property is located within a Commercial or Industrial Zone and the neighboring property is located within a Multi-family

Zone, the maximum lighting level at the shared property line shall be 0.2 foot-candles.

**(2) Abutting or Within a Commercial or Industrial Zone.** Where a property is located within a Commercial or Industrial Zone and the neighboring property is located within a Commercial or Industrial Zone, the maximum lighting level at the shared property line shall be 0.25 foot-candles.

#### **E. General requirements.**

**1. Shielding.** All outdoor light fixtures shall be fully shielded or full cut off, except as provided below.

a. Decorative string lights are not required to be shielded.

b. Lights at building entrances located under an overhang or building element are not required to be shielded provided that none of the light emitted by the fixture projects above the horizontal of the edge of the overhang or building element.

c. Outdoor light fixtures used for outdoor recreational facilities shall be fully shielded except when such shielding would cause impairment to the visibility required in the intended recreational activity. In such cases, partially shielded fixtures and downward lighting methods shall be utilized to limit light pollution, glare, and light trespass to a reasonable level as determined by the Director.

d. Partially shielded light fixtures may be allowed provided the light source is obscured by translucent glass or other means, the light fixture does not exceed 850 lumens, and the lighting complies with all other provisions of this Section.

**2. Externally Illuminated Signs, Advertising Displays and Building Identification.** Externally illuminated signs, advertising displays and building identification shall use top mounted light fixtures which shine downward.

**3. Maximum Height.** Lighting fixtures shall be installed at the lowest height required to achieve the design purpose of the lighting fixture.

**a. Building Mounted.** Light fixtures shall not exceed the height of the building upon which it is attached.

**b. Freestanding Light Fixtures.** The maximum height of freestanding light fixtures and lighting fixtures mounted on a structure or feature other than a building is as follows:

(1) Within 100 feet of a Residential Zone: 15 feet from finished grade.

(2) Other Locations: 20 feet from finished grade.

**c. Exceptions.** The Director may allow additional height for activities, uses, or development with unique lighting needs; for accentuating historic architectural

features of a building, accentuating signage and/or landscape features; lighting of recreational facilities; or for security purposes.

**4. Glare Prevention.** All lights shall be directed and oriented to prevent light spillover and glare onto adjacent properties. No unobstructed beam of exterior light shall land off-site.

**5. Traffic Safety.** Lighting shall be designed so as not to interfere with vehicular traffic on any portion of a street.

**6. Kelvin.** Light fixtures for outdoor security lighting shall not exceed 4,000 Kelvin. All other outdoor light fixtures shall not exceed 3,000 Kelvin.

**7. Timing Controls.** Outdoor lighting shall be turned off during daylight hours and between 9:00 p.m. and sunrise the following day, except as provided below.

**a. When People are Present.** Outdoor lighting may remain on when people are present in the outdoor areas being illuminated, except as provided below.

(1) In Residential Zones and any area adjacent to a Residential Zone, outdoor lighting shall be turned off as follows:

(a) Sunday through Thursday: between 10:00 p.m. and sunrise the following day.

(b) Friday and Saturday: between midnight and sunrise the following day.

**b. Code Required Lighting.** Building or other construction and safety code required lighting for steps, stairs, walkways, entrances, parking areas, and other building and site features that is dimmed to the minimum light level necessary to meet code requirements.

**c. Safety and Security Lighting.**

(1) Motion-Controlled Security Lighting. Security lighting may be controlled by a motion-sensor switch between the hours of 9:00 p.m. and sunrise the following day provided the lighting does not remain on longer than five minutes after activation.

(2) Commercial and Industrial Zones Not Adjacent to Residential Zones. Outdoor security lighting in Commercial and Industrial Zones not adjacent to a Residential Zone may remain on between 9:00 p.m. and sunrise the following day provided lights are dimmed to the minimum level to meet safety and security requirements and are on a timer or sensor that automatically extinguishes the light when sufficient daylight is available.

(3) Additional Security Lighting. Additional security lighting may be allowed through the approval of the Conditional Use Permit or Development Plan, as applicable.

**d. On-Premise Signs.** All illuminated advertising signs shall not be illuminated between 11:00 p.m. and sunrise the following day, except that on-premises signs may be illuminated while the business is open to the public.

**F. Submittal of plans and evidence of compliance.** Any application for a permit that includes outdoor light fixtures subject to the standards of this Section shall include evidence that the proposed outdoor lighting will comply with all of the standards of this Section. The application shall include:

1. Plans showing the locations of all outdoor lighting fixtures.
2. Description of the outdoor lighting fixtures including manufacturers catalog cuts and drawings. Descriptions and drawings shall include lamp or bulb type, wattage, lumen output, beam angle, and shielding.
3. Photometric plans showing foot-candle readings every ten feet within the property or site and ten feet beyond the property lines, except as provided below.
  - a. Applications for outdoor lighting associated with residential development of four or fewer units and property-owner installed lighting are not required to submit photometric plans unless requested by the Director due to project location, size, use, and proposed lighting.
4. The above plans and descriptions shall be sufficiently complete to enable the plan examiner to readily determine whether compliance with the requirements of this Section have been met.

**G. Temporary exemption.** The following temporary exemptions may be allowed in accordance with the provisions of Section 35.442.180 (Temporary Uses and Trailers).

1. The Director may grant a temporary exemption from one or more requirements of this Section for such activities, including, but not limited to circuses, fairs, carnivals, sporting events, and promotional activities, only if all of the following findings are first made:
  - a. The purpose for which the lighting is proposed is not intended to extend beyond 30 days.
  - b. The proposed lighting is designed in such a manner as to minimize light pollution as much as feasible.
  - c. The proposed lighting will comply with the purpose of this Section.
2. The application for a temporary exemption shall at a minimum include all of the following information:
  - a. Name and address of applicant and property owner.
  - b. Location of proposed fixtures.
  - c. Type, wattage and lumen output of lamp(s).

d. Type and shielding of proposed fixtures.

e. Intended use of lighting.

f. Duration of time for requested exemption.

g. The nature of the exemption.

3. Such other information as the Department may request.

### **SECTION 3:**

DIVISION 35.3, Montecito Site Planning and Other Project Standards, of Section 35-2, the Montecito Land Use and Development Code, of Chapter 35, Zoning, of the Santa Barbara County Code, Section 35.430.150, Setback Requirements and Exceptions, of Chapter 35.430, Standards for All Development and Land Uses, is hereby amended to read as follows, and all subsequent figures are updated as applicable:

- A. Purpose.** This Section provides standards for the use and minimum dimension of setbacks. These standards provide open areas around structures for: visibility and traffic safety; access to and around structures; access to natural light, ventilation and direct sunlight; separation of incompatible land uses; and space for landscaping and recreation.
- B. Setback requirements.**
- 1. General.** Each structure shall be located on its site so that it is set back from property lines and other structures in compliance with the setback requirements of the applicable zone in Division 35.2 (Montecito Zones and Allowable Land Uses), and with any setbacks established for specific uses by Chapter 35.442 (Standards for Specific Land Uses), except as otherwise provided by this Section or this Development Code.
  - 2. Property lines and rights-of-way.** No portion of any structure, including eaves or roof overhangs, shall extend beyond a property line or into a public street right-of-way, except as provided by Subsection 35.444.020.D.1.d (Extension over neighboring property).
- C. Measurement of setbacks.** The setbacks required by Subsection B (Setback requirements) above shall be measured as follows.
- 1. Front setback.** A front setback shall be measured at right angles from the front line of the lot.
    - a. Corner lot.** A corner lot shall have a front setback along each property line adjacent to a street. If the corner lot has a lot width of 100 feet or more, then each front setback shall be considered to be a primary front setback. If the corner lot has a lot width of less than 100 feet, then the front setback adjacent to the front line (see definition of Front Line) of the lot shall be considered the primary front setback and the front



setback that is not adjacent to the front line shall be considered a secondary front setback. See Figure 3-5 (Corner Lot Setbacks) below.

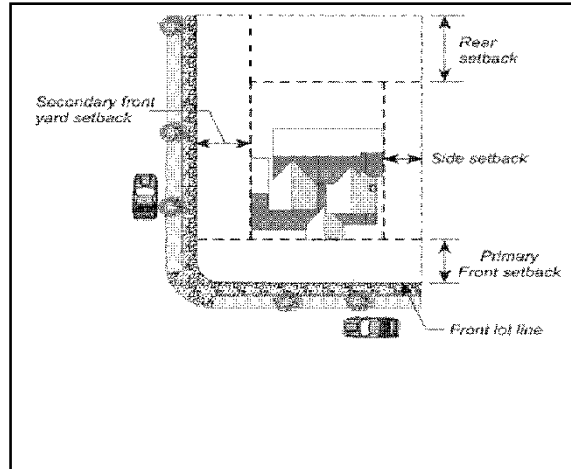
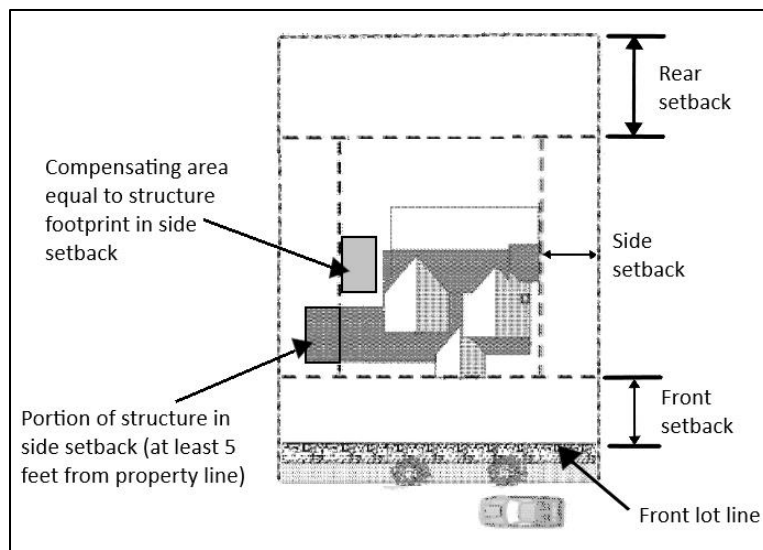

**Figure 3-5 – Corner Lot Setbacks**

- (1) Corner lot 100 feet or greater in width.** There shall be a primary front setback along each street abutting the lot and all such setbacks shall conform to the front setback requirements of the applicable zone.
- (2) Corner lot less than 100 feet in width.** There shall be a primary front setback along the property line considered the front line of the lot. The secondary front setback along the property line not considered the front line shall be not less than 20 percent of the width of the lot, but in no case shall said secondary front setback be less than 10 feet.
- b. Through lot.** A through lot shall provide front setbacks as required by the applicable zone adjacent to each abutting street.
- c. Sloping lot setback.** Where the elevation of the ground at a point 50 feet from the centerline of any street is seven feet or more below or above the grade of the centerline, the front setback for a private detached garage (not carport) may be decreased by 40 percent and the front setback for a dwelling may be decreased by 20 percent, provided that the front face of the garage is no closer than 10 feet to the abutting street right-of-way.
- 2. Side setbacks.** A required side setback shall be measured at right angles from the side property line, establishing a setback line parallel to the side property line which extends between the front and rear setbacks.

  - a. Side setback adjacent to alley.** In computing the width of a side setback, if the setback abuts an alley, and the owner of the lot owns all or one-half of the underlying fee of the alley, up to one-half of the width of the alley may be included in the side yard.

- b. Through lot.** On a through lot, the side setbacks shall extend the full depth of the lot between the front setbacks.
- c. Side setback variations in R-1/E-1 and R-2 zones.** The required side setback for portions of a structure, including attached and detached accessory structures, may be varied subject to all of the following limitations. See Figure 3-6 (Variable Side Setback).
- (1) No portion of the structure shall be less than five feet from the side lines of the lot.
  - (2) No portion of an exterior wall of a structure containing non-fixed windows or doors opening into rooms of a structure (except a garage or other non-habitable space) shall be located closer to the side lines of a lot than the required side setback prior to any variation allowed by Subsection b.(3) below.
  - (3) A portion of a structure may be located within the required side setback provided that the footprint area of the portion of the structure that intrudes into the required side setback, combined with the footprint area of any other existing portions of the structure that intrude into the required side setback, shall be compensated by an equal or greater area that is not covered by any building footprint area located outside of and adjacent to the same side setback and the side setback line without any intervening obstruction. The compensating area used to vary a side setback shall be located adjacent to the side setback line that is being varied, outside of the required rear and front setback areas, and shall not be located farther from the portion of the structure intruding into the setback area adjacent side lot line than one-half of the lot width depth.
  - (4) The compensating area used to vary a side setback shall not be used to vary a rear setback on the same lot.



**Figure 3-6 – Variable Side Setback**

- 3. Rear setback.** The rear setback shall be measured at right angles from the rear property line, establishing a setback line parallel to the rear property line.
  - a. Corner lot.** The rear setback for a corner lot backing upon a key lot may be reduced to the size of the required side setback for the key lot or 10 feet, whichever is greater, provided that the total front, side, and rear setback area required by the applicable zone is not reduced. An accessory structure on a corner lot backing on a key lot shall be set back from the rear property line by a distance equal to the side setback requirements applicable to the key lot.
  - b. Rear setback adjacent to alley.** In computing the depth of a rear setback, if the setback abuts an alley, and the owner of the lot owns all or one-half of the underlying fee of the alley, up to one-half of the width of the alley may be included in the rear setback.
  - c. Rear setback on triangular lot.** Where a triangular lot has no rear lot line because its side lot lines converge to a point, an assumed line 10 feet long within the lot, parallel to and at the maximum possible distance from the front lot line, shall be deemed to be the rear lot line for the purpose of measuring the required rear setback. See Figure 3-~~67~~ (Triangular Lot Rear Setback Measurement).

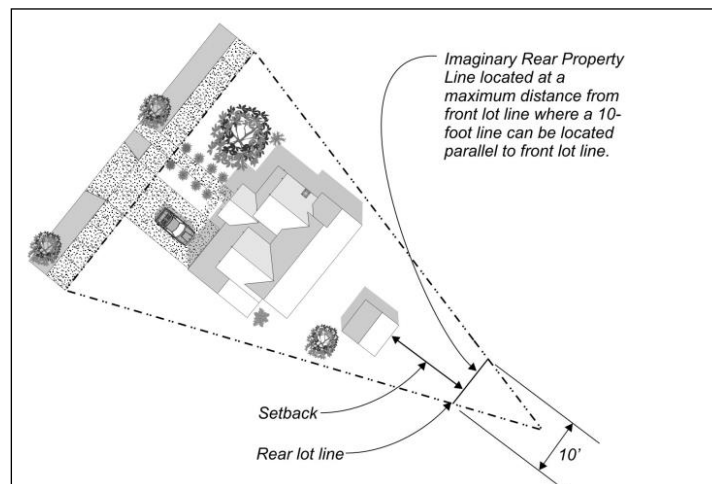

**Figure 3-~~67~~ – Triangular Lot Rear Setback Measurement**

- d. Rear setback variations in R-1/ E-1 and R-2 zones.** The required rear setback for portions of a structure, including attached and detached accessory structures, may be varied subject to all of the following limitations. See Figure 3-8 (Variable Rear Setback).
  - (1) No portion of a structure used for dwelling purposes shall be closer than 15 feet to the rear line of the lot.

- (2) A portion of a structure may be located within the required rear setback provided that the footprint area of the portion of the structure that intrudes into the required rear setback, combined with the footprint area of any other existing portions of the structure that intrude into the required rear setback, shall be compensated by an equal or greater area that is not covered by any footprint area located outside of and adjacent to the rear setback and the rear setback line without any intervening obstruction. The compensating area used to vary a rear setback shall be located outside the required side setback areas and shall not be located farther from the portion of the structure intruding into the setback area rear lot line than one-half of the lot depth width.
- (3) The compensating area used to vary a rear setback shall not be used to vary a side setback on the same lot.

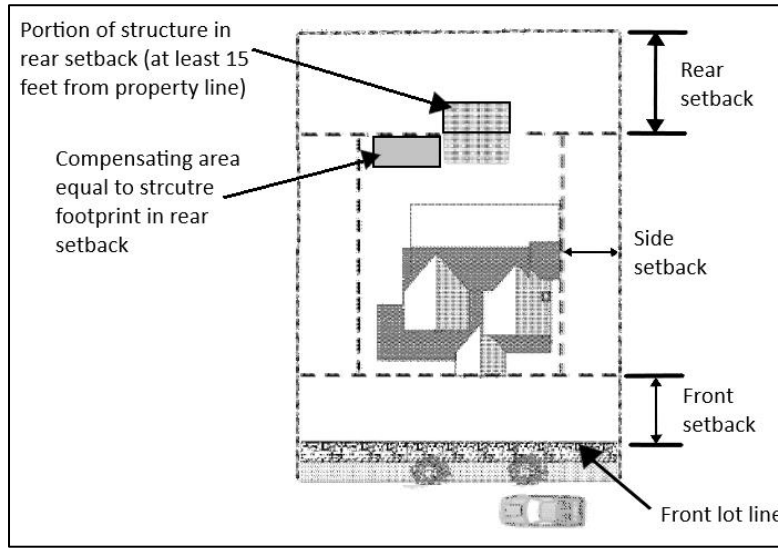

**Figure 3-8 – Variable Rear Setback**

**4. Interior and odd-shaped lots.**

- a. **Interior lot.** The setback requirements of the applicable zone shall not apply, and any structure located on an interior lot shall have a setback of at least 10 feet from all property lines, and the total setback area shall equal the total area of all setbacks required by in the applicable zone. See Figure 3-79 (Interior Lot) below. Where no setback is required by the applicable zone, a setback of 10 feet shall not be required.
- b. **Odd-shaped lots.** In the case of odd-shaped lots, the Director shall determine the required setbacks, which widths and depths shall approximate as closely as possible the required widths and depths of corresponding setbacks on rectangular lots in the applicable zone district.

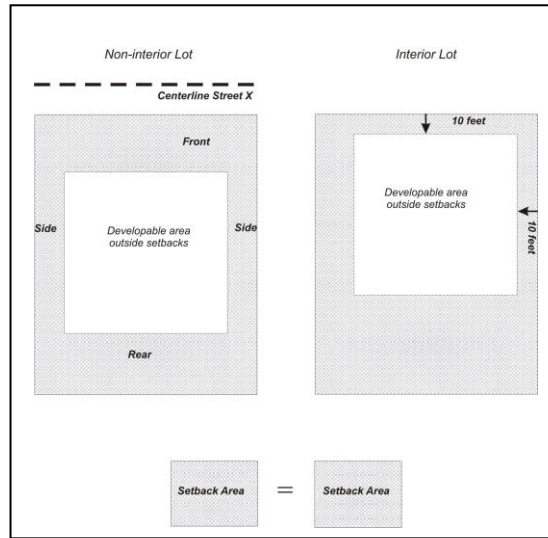

**Figure 3-79 – Interior Lot**

- 5. Setback shown on Final Map or Parcel Map or Final Development Plan.** Where a setback line is called for or shown on a Final Map or Parcel Map or Final Development Plan, the required setback shall be that shown on the Final Map, Parcel Map, or Final Development Plan.
- D. Limitations on the use of setbacks, allowable projections into setbacks.** Every part of a setback shall be unobstructed from the ground to the sky, except as otherwise provided in this Section.
1. The ordinary projection of sills, belt courses, buttresses, cornices, chimneys, eaves, outdoor stairways, and ornamental features may extend into a required setback no more than three feet. Handrails on outdoor stairways may extend into the setback an additional six inches.
  2. Fire escapes, balconies, and unroofed and unenclosed porches or landings, may extend into a setback as provided below when constructed and placed in a manner that shall not obstruct light to or ventilation of structures or the ready use of the setbacks for ingress or egress:
    - a. The front or rear setback by four feet
    - b. A side setback by three feet.
  3. Ornamental garden and landscaping structures without roofs (e.g., fountains, elevated ponds, planters) may be located within the front and side setbacks provided the feature is either:
    - a. Less than 30 inches high, or

- b. Covers an area of 50 square feet or less and is less than either six feet in height and, if located within a vision clearance area, is consistent with the regulations of Subsection 35.430.090.I (Vision clearance).
- 4. Decks less than 32 inches in vertical distance as measured from finished grade to the top of the decking material may be located within the front or side setback unless located in a designated Environmentally Sensitive Habitat area.
- ~~5. Non-habitable structures may be located in the side setback provided that the structures comply with all of the following:~~
  - ~~a. Cumulatively the structures do not occupy an area greater than 10 percent of the side setback in which they are located, or 120 square feet, which ever is less.~~
  - ~~b. Do not contain any utilities.~~
  - ~~c. Are screened from view from abutting properties by a wall or fence at least as tall as the structure.~~
  - ~~d. Are located no closer than five feet to any other structure located on the same lot.~~
- 65. Pedestals supporting utility meters no greater than four feet in height and 24 square feet in area may be located in a front or side setback provided they are completely screened from view from any public or private street and adjoining lots.

#### **SECTION 4:**

DIVISION 35.3, Montecito Site Planning and Other Project Standards, of Section 35-2, the Montecito Land Use and Development Code, of Chapter 35, Zoning, of the Santa Barbara County Code, Chapter 35.438, Sign Standards, is hereby amended to repeal the existing Chapter 35.438, Sign Standards, in its entirety and to adopt a new Chapter 35.438, Sign Standards, to read as follows:

#### **CHAPTER 35.438 - SIGN STANDARDS**

##### **35.438.010 – Purpose**

The purpose of this Chapter is to promote the public health, safety, and welfare through a comprehensive system of reasonable, effective, consistent, content-neutral, and nondiscriminatory sign standards and requirements. More specifically, this Chapter is intended to:

- A. Balance public and private objectives by allowing adequate avenues for both commercial and non-commercial messages;
- B. Allow signs to serve as an effective channel of communication while preventing visual clutter that will detract from the aesthetic character of the County;

- C. Maintain and enhance the County’s appearance by regulating the location, number, type, quality of materials, size, illumination, and maintenance of signs;
- D. Restrict signs that may create a nuisance to nearby properties, violate privacy, or create hazards or unreasonable distractions for pedestrians or drivers;
- E. Provide clear and unambiguous sign standards that enable fair and consistent enforcement; and
- F. Ensure that the constitutionally guaranteed right of free speech is protected.

See “Signs” within Division 35.10 (Glossary) for definitions related to signage as used within this Chapter.

### **35.438.020 – Applicability**

The provisions of this Chapter apply to all signs in all zones, erected, constructed or physically altered on or after the effective date of the Ordinance amending this Chapter, unless otherwise specified.

- A. Message Neutrality.** It is the County’s policy and intent to regulate signs in a manner consistent with the U.S. and California constitutions, which is content neutral as to non-commercial speech and does not favor commercial speech over non-commercial speech.
- B. Registered Mark.** The provisions of this Chapter shall not require alteration of the display of any registered mark, trademark, service mark, trade name, or corporate name that may be associated with or incorporated into a registered mark, where such alteration would require the registered mark to be displayed in a manner differing from the mark as exhibited in the certificate of registration issued by the United States Patent and Trademark Office. It is the responsibility of the applicant to establish that a proposed sign includes a registered mark.
- C. Noncommercial Signs.** Non-commercial signs are allowed wherever commercial signage is permitted and are subject to the same standards and total maximum allowances per site or building of each sign type specified in this Chapter. For purposes of this Chapter, all non-commercial speech messages are deemed to be “on-site,” regardless of location.

### **35.438.030 – Exemptions**

The following signs are exempt from the permit requirements of this Chapter, do not count towards the maximum number of signs or maximum sign area, and may be located in setback areas, provided that they are erected on an allowed and, where applicable, permitted, structure and conform to the specified standards.

- A. Address Signs.** Required address identification signs that are in conformance with the Building Code.

- B. Commercial Displays on Vehicles.** Displays that are part of the vehicle and related to the goods or services provided by the vehicle owner or operator and public transit/public carrier graphics on properly licensed buses, taxicabs, and similar vehicles for hire that legally pass through the County.
- C. Construction Signs.** Nonilluminated construction informational signs not to exceed eight square feet per site, erected after the required permits for the construction have been obtained and removed prior to final inspection.
- D. Directional Signs.** Non-illuminated directional signs not more than eight square feet in area or four feet in height for the direction of the public such as outlining/assisting vehicle and pedestrian circulation within a site, to ingress and egress, and to facilities such as restrooms, telephones, walkways, and other similar features.
- E. Flags.** Flags that do not display a commercial message.
- F. Gas Pump Signs.** Signs on or within five feet of a gas pump.
- G. Government Signs.** Signs and devices erected by a governmental entity, including, but not limited to, Santa Barbara County and public schools.
- H. Historic Plaques and Commemorative Signs.** Historic plaques, memorial signs or tablets, or commemorative signs indicating names of buildings and dates of building erection, either attached to or cut into the surfaces of buildings, with a maximum allowable sign area of four square feet per sign.
- I. Informational Signs.** Informational signs not more than two square feet in area indicating information such as hours and days of operation, whether a business is open or closed, payment information, crop identification, and emergency address and telephone numbers.
- J. Interior Signs.** Signs that are in the interior areas of a building and at least 12 inches from a window, door, or other exterior wall opening.
- K. Manufacturer’s Mark.** Manufacturer’s marks, including signs on items such as vending machines, gas pumps, and ice containers with a maximum allowable sign area of four square feet per sign.
- L. Nameplate.** One nameplate for each tenant or occupant not to exceed two square feet in area indicating the name of the occupant or tenant.
- M. No Trespassing Signs.** “No Trespassing” signs not more than one square foot in area and located a minimum of 50 feet from any other “No Trespassing” sign or in compliance with the requirements of law.
- N. Official and Safety Signs.** Official notices issued by a court, public body, or office and posted in the performance of a public duty; safety and other notices posted by a utility or other quasi-public agency; signs erected by a governmental body to direct or regulate pedestrian or



vehicular traffic; non-commercial bus stop signs erected by a public transit agency, or other signs required for safety or authorized by law.

**O. Open House Directional Signs.** Up to four off-site signs directing the public to "open house" events for the viewing of lots, premises, dwellings or structures that are for sale, lease, or rent, are permitted on private land, provided they comply with the following standards:

1. No sign or signs exceeds four square feet in area, or three feet in height from finished grade.
2. The sign or signs may not be placed more than two hours before the start or remain more than two hours after the conclusion of the open house event.

**P. Political, Social Issue, and Other Noncommercial Signs.** Signs informing of political candidates, parties, issues, measures, propositions, philosophies or personal beliefs, and which are not commercial messages, shall be exempt from all regulations of this Chapter, except that such signs shall not be placed within the public right-of-way. Political signs shall conform to the requirements of the California State Code for placement and removal.

**Q. Real Estate Signs.** One nonilluminated, on-site sign pertaining to the sale, lease, or rental of a structure or land, not exceeding six square feet in a Residential Zone or 25 square feet in any zone other than a Residential Zone.

**R. Subdivision Signs.** The following signs are allowed on the site of a subdivision of five or more lots where a Tentative Map has been approved by the County.

1. One nonilluminated, on-site sign per street frontage with a maximum size of 32 square feet per sign is allowed for a maximum of one-year period.
2. One nonilluminated lot identification sign per undeveloped lot containing only the subdivision lot number, with a maximum size of one square foot, is allowed until the subject lot is sold.

**S. Temporary Signs.**

- 1. Temporary Window Signs.** Temporary window signs not exceeding four square feet or 15 percent of the window area, whichever is greater, displayed for a maximum of 30 consecutive days.
- 2. Temporary Event Balloons, Inflatable Signs, Streamers, Pennants and Other Attention-Getting Devices.** Balloons, banners, inflatable signs, streamers, pennants, and other attention-getting devices associated with a temporary event. The balloons, inflatable signs, streamers, pennants, and other attention-getting devices shall be erected no more than five days prior to the associated temporary event and shall be removed within 24 hours after the end of the associated temporary event.

**3. Other Temporary Signs.** Other temporary signs, including garage and yard sale signs, not exceeding six square feet displayed for a maximum of 30 consecutive days. A maximum of two temporary signs may be displayed at the same time on a single site.

### **35.438.040 – Prohibitions**

Unless otherwise permitted by a specific provision of this Chapter, the following sign types are prohibited:

**A. Animated or Moving Signs.** Animated, flashing, blinking, reflecting, revolving, or other similar sign with visibly moving or rotating elements or visible mechanical movement of any kind except when integrated into a gas pump.

**B. Balloons, Inflatable Signs, Streamers, Pennants and Other Attention-Getting Devices.** Balloons, inflatable signs, streamers, pennants, and other attention-getting devices, made of light-weight fabric or similar material, designed to rotate or move with the wind, that direct, promote, or that are otherwise designed to attract attention.

**C. Mobile Billboards.** Any sign carried or conveyed by a vehicle for the primary purpose of general advertising for hire. This prohibition eliminates mobile billboard advertising within the County to reduce traffic congestion, promote the safe movement of vehicular traffic, to reduce air pollution, and improve the aesthetic appearance of the County. This prohibition does not apply to displays that are part of the vehicle and related to the goods or services provided by the vehicle owner or operator or to public transit/public carrier graphics on properly licensed buses, taxicabs, and similar vehicles for hire that legally pass through the County.

**D. Off-Site Signs.** Any sign advertising any activity, business, product, or service that are not conducted on the premises upon which the sign is located.

**E. Roof Signs.** Signs constructed upon or over a roof; placed on a rooftop structure such as penthouse walls, chimneys, or mechanical enclosures; or placed so as to extend above the roofline or parapet.

**F. Signs Located in the Public Right-of-Way or on Public Property.** Other than official government signs or warning signs required by law, no inanimate sign may be placed in or project into the public right-of-way or on public property unless authorized by an encroachment permit.

**G. Signs Affixed to Trees.** Signs affixed to or cut into trees or other living vegetation.

**H. Signs on Terrain.** Signs cut, burned, marked, or displayed in any manner on a street, sidewalk, cliff, hillside, or other terrain feature.

**I. Signs Creating Traffic or Pedestrian Safety Hazards.** Signs placed, located, or displayed in such a manner as to constitute a traffic or pedestrian safety hazard. This includes, but is not limited to:

- 1. Signs that obstruct use of any door, window, or fire escape.**
- 2. Signs that impede normal pedestrian use of public sidewalks. A minimum unobstructed width of four feet must always be maintained.**
- 3. Signs that constitute a traffic hazard or obstruct the view of traffic, any authorized traffic sign, or signal device.**
- 4. Signs that create confusion or conflict with any authorized traffic sign or signal device due to color, location, wording, or use of specific phrases, symbols, or characters.**

**J. Signs Producing Noise or Emissions.** Signs producing visible smoke, vapor, particles, odor, noise, or sounds that can be heard at the property line shall be prohibited. This prohibition excludes menu boards with voice units at Drive-Through Facilities and signs erected for public safety, including, but not limited to, pedestrian crossing signs.

**K. Signs for Prohibited Uses.** A sign displaying a commercial message promoting a business that is a prohibited use and has not been established as a legal nonconforming use.

**L. Unauthorized Signs.** Signs shall not be placed on private or public property without the permission of the property owner.

### **35.438.050 – Sign Measurement**

**A. Measuring Sign Area.** The area of a sign face includes the entire area within the perimeter of a maximum of two squares and/or rectangles that enclose the extreme limits of the frame or outline of the sign copy, or where there is no frame or outline, letters, pictures, symbols, logos, artwork, emblems, color, or other details conveying a message. Supporting structures, such as sign bases and columns, are not included in sign area provided that they contain no lettering or graphics. The area of an individual sign shall be calculated as follows.

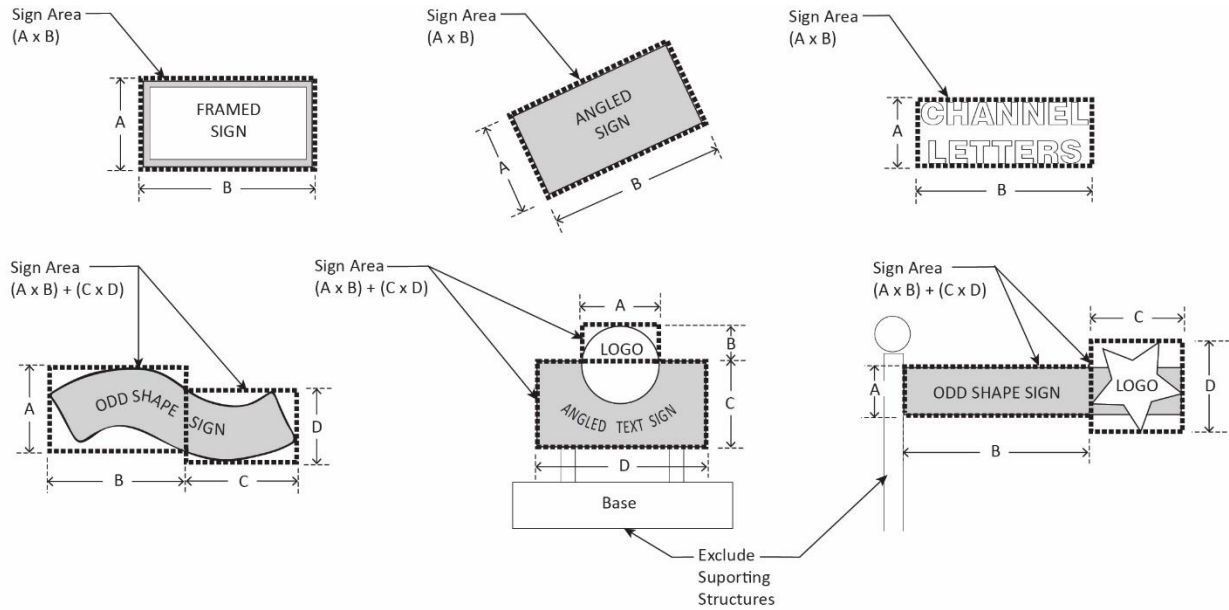

**Figure 3-11 – Measuring Sign Area**

- 1. Single-Faced Signs.** The sign area of a sign with a single face area is the area of the sign face.
- 2. Double-Faced Signs.** Where two faces of a double-faced sign are located two feet or less from one another at all points, or located at an interior angle of 45 degrees or less from one another, the sign area of double-faced signs is computed as the area of one face. Where the two faces are not equal in size, the larger sign face will be used. Where two faces of a double-faced sign are located more than two feet or greater than 45 degrees from one another, both sign faces are counted toward sign area.

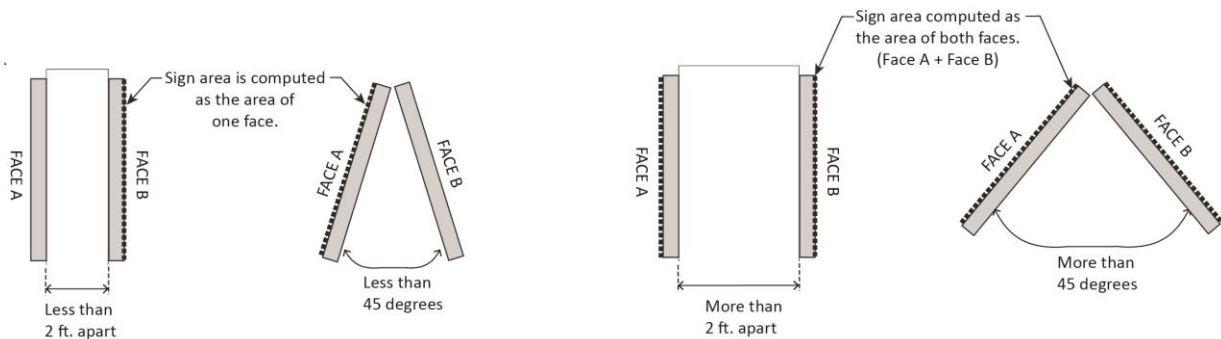

**Figure 3-12 – Measuring Double-Faced Signs**

**3. Multi-Faced Signs.** On a three-faced sign, where at least one interior angle is 45 degrees or less, the area of two faces (the largest and smallest face) must be summed to determine sign area. In all other situations involving a sign with three or more sides, sign area will be calculated as the sum of all faces.

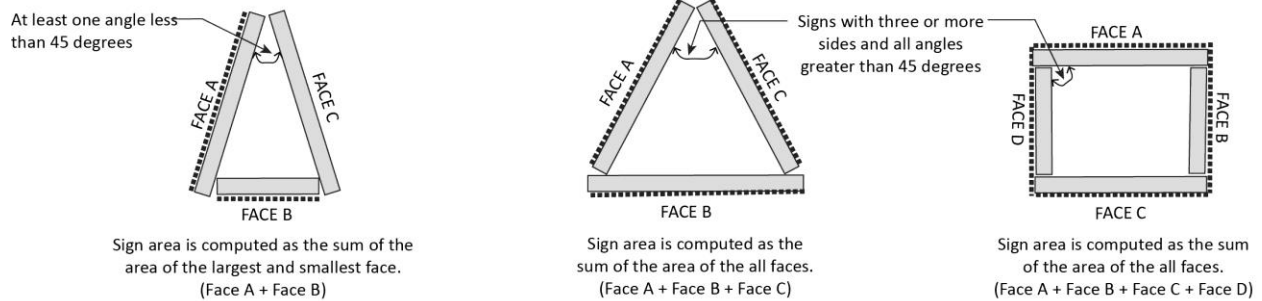

**Figure 3-13 – Measuring Multi-Faced Signs**

**4. Three-Dimensional (3D) Signs.** Signs that consist of, or have attached to them, one or more three-dimensional objects (i.e., balls, cubes, clusters of objects, sculpture, or statue-like trademarks), may have a sign area that is the sum of all areas using the four vertical sides of the smallest rectangular prism that will encompass the sign.

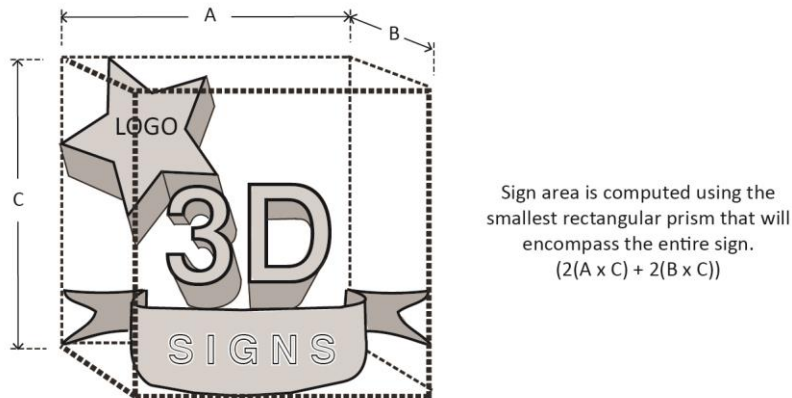

**Figure 3-14 – Measuring 3D Signs**

**B. Measuring Sign Height.** The height of a sign is the vertical distance from the uppermost point used to measure sign area to the existing grade immediately below the sign.

**C. Measuring Sign Clearance.** Sign clearance shall be measured as the smallest vertical distance between finished grade and the lowest point of the sign, including any framework or background embellishments.

**D. Street Frontage.** The length of street frontage is measured along the property line adjacent to the public right-of-way.

**E. Building Frontage.** Building frontage shall be measured as the widest lineal dimension, parallel to the ground, of a continuous frontage. A building's frontage is considered continuous if projections or recesses in a building wall do not exceed 10 feet in any direction.

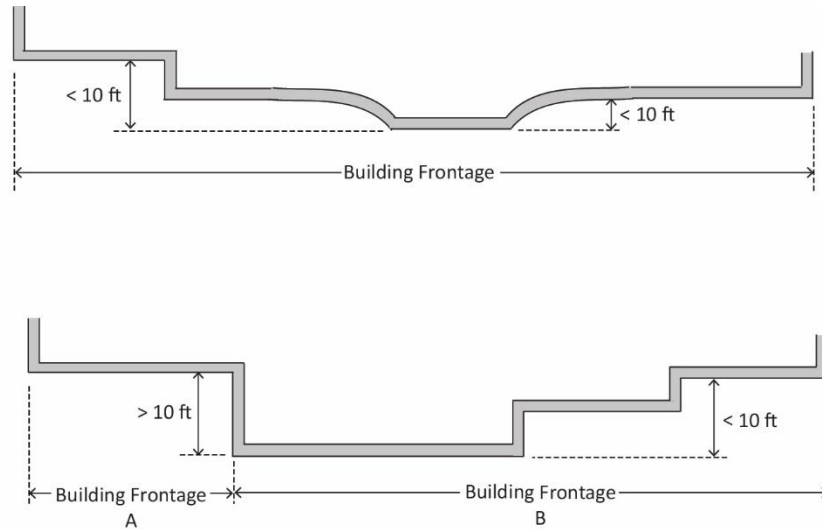

**Figure 3-15 – Building Frontage**

**35.438.060 – General Provisions**

This Section establishes general standards that apply to all sign types and in all zone districts.

**A. Applicable Codes.** In addition to complying with the provisions of this Section, all signs must be constructed in accordance with applicable construction, sign, and building codes and all other applicable laws, rules, regulations, and policies.

**B. Materials.** Signs shall be made of sturdy, durable materials. Paper, cardboard and other materials subject to rapid deterioration shall be limited to temporary signs. Signs made of fabric are limited to awnings, canopies, flags, and temporary signs.

**C. Minimum Sign Clearance.** Signs shall have a minimum of eight feet clearance when located above any walkway or other area people may walk.

**D. Illumination.** Where allowed, all sign illumination shall be consistent with Section 35.430.120 (Outdoor Lighting).

**E. Changeable Copy.**

**1. Manual Changeable Copy.** Manually changeable copy is allowed.

**2. Automatic Changeable Copy and Electronic Message Center Signs.** Electronic Message Center (EMC) signs and automatic changeable copy in which copy can be changed or

altered by electric, electro-mechanical, electronic, or any other artificial energy means, are allowed subject to the following standards.

- a. **Limitations.** Electronic Message Center (EMC) signs and automatic changeable copy are limited to institutional signs and as fuel price signs at service stations.
- b. **Display Duration.** The display shall change no more frequently than once every eight seconds and must have an unlighted interval between copy displays of 0.3 seconds or more.
- c. **Static Message.** Displays shall contain static messages only, and shall not have movement, or the appearance or optical illusion of movement, of any part of the sign structure, design, or pictorial segment of the sign, including the movement or appearance of movement of any illumination, or the flashing, scintillating or varying of light intensity.
- d. **Light Intensity.** EMC signs shall have a maximum light intensity of 0.3 foot-candles over ambient lighting conditions when measured at a distance equal to the square root of 100 times the area of the sign in square feet. All electronic copy must be equipped with a sensor or other device that automatically determines the ambient illumination and is programmed to automatically dim according to ambient light conditions, or that can be adjusted to comply with the 0.3 foot-candle measurements.
- e. **Automatic Controls.** All electronic message displays shall be equipped with automatic controls to allow for adjustment of brightness based on ambient lighting conditions.

**35.438.070 – Signage Allowances and Standards**

Table 35.438.070 (Signage Allowances and Standards) establishes signage allowances for specific uses and development and standards applicable to specific sign types.

<b><u>Table 35.438.070: Signage Allowances and Standards</u></b>							
<u>Sign Type</u>	<u>Type of Development</u>	<u>Maximum Sign Area</u>	<u>Maximum Number of Signs</u>	<u>Maximum Sign Height</u>	<u>Maximum Projection</u>	<u>Location</u>	<u>Illumination</u>
<u>Awning and Canopy Signs</u>	<u>Nonresidential</u>	<u>10 square feet per sign</u>	<u>One per awning or canopy</u>	<u>18 feet</u>	<u>Shall not project further than the edge of the awning or canopy</u>	<u>Shall be attached to or painted or printed on an awning, canopy, or similar building feature</u>	<u>Not allowed</u>

**Table 35.438.070: Signage Allowances and Standards**

<u>Sign Type</u>	<u>Type of Development</u>	<u>Maximum Sign Area</u>	<u>Maximum Number of Signs</u>	<u>Maximum Sign Height</u>	<u>Maximum Projection</u>	<u>Location</u>	<u>Illumination</u>
<u>Freestanding Signs</u>	<u>Residential Development with 4 or more units</u>	<u>Total freestanding sign area of 20 square feet per entrance to the development</u>	<u>Two per entrance to the development</u>	<u>10 feet</u>	<u>Shall not project into a required setback area or public right-of-way</u>	<u>Shall be located outside required setback areas or a minimum of 5 feet from the property line, whichever is greater</u>	<u>May be illuminated</u>
	<u>Nonresidential</u>	<u>Commercial and Industrial Zones: 100 square feet per sign Other Zones: 25 square feet per sign</u>	<u>Agricultural Zones: Two per site Other Zones: One plus one per 125 feet of street frontage over 125 feet</u>	<u>Commercial and Industrial Zones: 30 feet Other Zones: 10 feet</u>			
<u>Portable Signs (including A-board signs)</u>	<u>Nonresidential</u>	<u>6 square feet per sign</u>	<u>One per tenant space with building frontage</u>	<u>3 feet</u>	<u>Not applicable</u>	<u>May be located within setback areas. Shall not encroach upon parking spaces, driveways, pedestrian walkways, or required landscaped areas</u>	<u>Not allowed</u>
<u>Projecting and Shingle Signs</u>	<u>Nonresidential</u>	<u>6 square feet per sign</u>	<u>One per tenant space with building frontage</u>	<u>15 feet</u>	<u>Projecting Sign: Three feet from the structure façade Shingle Sign: Shall not project further than the outer edge of the feature from which it is suspended</u>	<u>-</u>	<u>Not allowed</u>



**Table 35.438.070: Signage Allowances and Standards**

<u>Sign Type</u>	<u>Type of Development</u>	<u>Maximum Sign Area</u>	<u>Maximum Number of Signs</u>	<u>Maximum Sign Height</u>	<u>Maximum Projection</u>	<u>Location</u>	<u>Illumination</u>
<u>Wall Signs</u>	<u>Residential Development with 4 or more units</u>	<u>Total wall sign area of 2 square feet per unit, maximum 20 square feet per sign</u>	<u>One per building frontage</u>	<u>Shall not extend higher than the building wall upon which they are attached</u>	<u>Maximum 6 inches from the building wall</u>	<u>Shall not cover or interrupt major architectural features such as doors, windows, or columns</u>	<u>May be illuminated</u>
	<u>Nonresidential</u>	<u>Total wall sign area of 1/8 the area of the wall upon which the sign is placed or attached</u>	<u>No limit, provided the total wall sign area per wall is not exceeded</u>				
<u>Window Signs</u>	<u>Nonresidential</u>	<u>25 percent of the window area</u>	<u>No limit, provided the maximum sign area per window is not exceeded</u>	<u>Shall not be placed on windows higher than the second story</u>	<u>Shall be flush with the window</u>	<u>-</u>	<u>Not allowed</u>
<u>Menu Boards</u>	<u>Drive-Through Facilities</u>	<u>Total menu board sign area of 36 square feet</u>	<u>Two per site</u>	<u>Freestanding menu boards: 8 feet</u> <u>Wall mounted menu boards: Shall not extend higher than the building wall upon which they are attached</u>	<u>Not applicable</u>	<u>Shall be located adjacent to a vehicle queuing lane for the service point of the drive-through facility</u>	<u>May be illuminated</u>

**35.438.080 – Modification to Sign Standards**

Modifications to the standards established in this Chapter are allowed in compliance with Section 35.472.130 (Overall Sign Plans).

**35.438.090 – Permit Requirements**

**A. Sign Certificate of Conformance Required.** A Sign Certificate of Conformance in compliance with Section 35.472.150 (Sign Certificates of Conformance) shall be required for all non-exempt signs. Except as otherwise expressly provided in this Chapter, it is unlawful for any person to affix, place, erect, suspend, attach, construct, structurally or electrically alter (not including a face change of sign copy), move, or display any temporary or permanent sign within the County without first obtaining a Sign Certificate of Conformance in compliance with Section 35.472.150 (Sign Certificates of Conformance).

**B. Overall Sign Plan.** An Overall Sign Plan in compliance with Section 35.472.130 (Overall Sign Plan) shall be required for the following:

1. Developments with four or more nonresidential tenants that will have individual signs.

**C. Design Review.** Design review in compliance with Section 35.472.070 (Design Review) is required for Overall Sign Plans, for signs that are part of a project that otherwise requires Design Review, and as required pursuant to any other provision of this Code.

**D. Application.** The required permit application shall be filed in compliance with Section 35.470.030 (Application Preparation and Filing).

### **35.438.100 – Nonconforming Signs**

**A. Continuance and Maintenance.** The use of a nonconforming sign may be continued, maintained, altered, reconstructed, and restored pursuant to Section 35.491.030, Nonconforming Structures.

**B. Removal.** Whenever a nonconforming sign has been abandoned, or the use of the property has been discontinued for a continuous period of at least 12 consecutive months, the nonconforming sign must be removed.

### **35.438.110 – Maintenance**

Each sign displayed within the County, including exempt signs, shall be maintained to comply with the following standards:

**A.** Graffiti on a sign shall be removed within seven days of notice of its placement on the sign.

**B.** The display upon any sign area of a sign shall be maintained in good condition, without rips, tears, and/or similar damage.

**C.** All parts, portions, units and materials composing a sign, together with the frame, background, surface, support or enclosure shall be maintained in a safe condition, painted, and adequately protected from weathering with all braces, bolts and structural parts and supporting frames and fastenings reasonably free from deterioration, rot, rust, and loosening so that they do not create a hazard to persons or property or constitute a nuisance.

- D. Any sign or sign structure that is sagging, leaning, fallen, decayed, broken, deteriorated, or in dilapidated condition shall be promptly repaired, to the satisfaction of the County, or removed.
- E. Whenever any sign, by virtue of its physical nature and condition, poses an immediate and serious threat to the public safety, the sign may be removed by County personnel, or its physical deficiency cured, to the extent necessary to protect the public safety. The cost of such removal or repair shall be assessed against the sign or property owner.
- F. An on-premise sign identifying an activity, business, service or product shall be removed within 30 days following the discontinuance of the activity, business, service or product. If the sign is not so removed, the Director may have the sign removed in accordance with the public nuisance abatement provisions of this Code.

### **35.438.120 – Violation and Enforcement of Sign Regulations**

- A. **Violations.** A sign set up, applied, erected, constructed, altered, affixed, repaired, installed, relocated, enlarged, converted, maintained, or projected as an image contrary to the provisions of this Chapter, shall be and is declared to be unlawful and a public nuisance and shall be subject to the provisions of Chapter 35.398 (Enforcement and Penalties).
- B. **Enforcement.** Enforcement of the provisions of this Chapter shall be in compliance with Chapter 35.398 (Enforcement and Penalties).

## **SECTION 5:**

DIVISION 35.4, Montecito Standards for Specific Land Uses, of Section 35-2, the Montecito Land Use and Development Code, of Chapter 35, Zoning, of the Santa Barbara County Code, Subsection b, New construction, of Subsection 2, Appearance and style, of Subsection F, Accessory dwelling units located within zones that allow one-family or multiple-family residential use, of Section 35.442.015, Accessory Dwelling Units and Junior Accessory Dwelling Units, of Chapter 35.442, Standards for Specific Land Uses, is hereby amended to read as follows:

### **b. New construction.**

- (1) The design of an accessory dwelling unit that will be attached to an existing building shall reflect the exterior appearance and architectural style of the existing building to which it is attached and use the same or comparable exterior materials, roof covering, colors, and design for trim, windows, roof pitch, and other exterior physical features.
- (2) Exterior lighting shall comply with Section 35.430.120 (Outdoor Lighting) and all of the following standards:

~~(a) All exterior lighting shall be hooded and fully shielded (i.e., full cutoff).~~

~~(a)~~ Each exterior lighting fixture shall not exceed 800 lumens if located within the Rural Area and 1,600 lumens if located within the Urban Area.

~~(c) Each exterior lighting fixture shall not exceed 3,000 Kelvin.~~

~~(b)~~ Landscape and pathway lighting fixtures shall not exceed four feet in height.

~~(e) Security lighting shall be controlled by a motion sensor switch or timer between dusk and dawn.~~

(3) Proposed landscaping shall be comparable to existing landscaping on the lot in terms of plant species and density of planting.

## **SECTION 6:**

DIVISION 35.4, Montecito Standards for Specific Land Uses, of Section 35-2, the Montecito Land Use and Development Code, of Chapter 35, Zoning, of the Santa Barbara County Code, Subsection a, Accessory structures, of Subsection 3, Height restrictions, of Subsection B, Development standards, of Section 35.442.020, Accessory Structures and Uses, of Chapter 35.442, Standards for Specific Land Uses, is hereby amended to read as follows:

**a. Accessory structures.** Except as provided below, the height limit for accessory structures is 16 feet ~~unless located in the rear setback, in which case the height limit is 12 feet.~~

**(1) Barns and stables.** Barns and stables shall comply with the height limit of the applicable zone unless located in the rear setback, in which case the height limit is 12 feet.

**(2) Fences and walls.** See Section 35.430.070 (Fences and Walls) for height limits for fences and walls.

**(3) Guesthouses, artist studios and cabañas.** See Section 35.442.120 (Guesthouses, Artist Studios, and Cabañas) for height limits for guesthouses, artist studios and cabañas.

**(4)** May be located above or below another accessory structure in areas where the H-MON overlay does not apply, provided the height of the combined accessory structure does not exceed 25 feet.

## **SECTION 7:**

DIVISION 35.4, Montecito Standards for Specific Land Uses, of Section 35-2, the Montecito Land Use and Development Code, of Chapter 35, Zoning, of the Santa Barbara County Code, Subsection 4, Setback requirements, of Subsection B, Development standards, of Section 35.442.020, Accessory Structures and Uses, of Chapter 35.442, Standards for Specific Land Uses,

is hereby amended to read as follows:

- 4. Setback requirements.** Detached accessory structures, including swimming pools, spas, and appurtenant equipment, shall comply with the front and side setback requirements of the applicable zone unless otherwise specifically allowed in compliance with this Development Code.

**a. Location in rear setback.**

- (1) Other accessory structures.** ~~Except as provided in Subsection B.4.a.(1), above, a~~  
A detached accessory structure, other than guesthouses, artist studios and cabañas (Section 35.442.120) may be located in the required rear setback provided that:

- (a) It is not attached to the principal structure.
- (b) It is not located closer than 10 feet to the principal structure.
- (c) The cumulative footprint of all accessory structures, including accessory dwelling units, that encroach into the setback does not exceed 30 percent of the required rear setback.
- (d) It does not exceed a height of 12 feet.
- (e) If located on a corner lot backing on a key lot, the accessory structure shall be set back from the rear property line by a distance equal to the side setback requirement applicable to the key lot.
- (f) A swimming pool, spa, and appurtenant equipment shall not be located closer than five feet to any property line.
- (g) An accessory structure may otherwise be located adjacent to the rear property line provided that all other provisions (e.g., building code or fire code requirements for separation between structures) are complied with.

- (2) A detached accessory structure developed in compliance with Subsection B.4.a.(1), above, does not require the provision of a varied setback and compensating area in accordance with Section 35.430.150.C.3.d.

- (3) A detached accessory structure, including guesthouses, artist studios and cabañas (Section 35.442.120), that does not meet the requirements of Subsection B.4.a.(1), may use a varied setback and compensating area in accordance with Section 35.430.150.C.3.d to be located partially within the required rear setback.

**b. Location in side setback.**

- (1) Non-habitable detached accessory structure(s) may be located in the side setback provided that the structure(s) comply with all of the following:

(a) Cumulatively the structures do not occupy an area greater than 10 percent of the side setback in which they are located, or 120 square feet, whichever is less.

(b) It does not contain any utilities.

(c) It does not exceed a height of 8 feet.

(d) It is located no closer than five feet to any other structure located on the same lot.

(2) An accessory structure developed in compliance with Subsection B.4.b.(1), above, does not require the provision of a varied setback and compensating area in accordance with Section 35.430.150.C.2.d.

(3) An accessory structure that does not meet the requirements of Subsection B.4.b.(1), above, may use a varied setback and compensating area in accordance with Section 35.30.150.C.2.d to be located partially within the required side setback.

**c. Corner lot setbacks.** Accessory structures located on a corner lot having a width of less than 100 feet shall not be located closer to the front line of the lot than the principal structure on that lot.

**d. Swimming pools and spas in setback area.** Swimming pools, spas, and appurtenant equipment shall not be located:

**(1) Lots other than interior lots.** In the required front or side setback areas and, if located within the rear setback, shall not be located closer than five feet to any property line.

**(2) Interior lots.** Closer than 10 feet to any property line.

## **SECTION 8:**

DIVISION 35.4, Montecito Standards for Specific Land Uses, of Section 35-2, the Montecito Land Use and Development Code, of Chapter 35, Zoning, of the Santa Barbara County Code, Subsection M, Cabaña, of Section 35.442.120, Guesthouses, Artist Studios, and Cabañas, of Chapter 35.442, Standards for Specific Land Uses, is hereby amended to read as follows:

**M. Cabaña.** A cabaña may be approved as an accessory structure provided that its use is accessory to a sports court or swimming pools, or is located on a lot directly adjacent to the sea.

**1. Definition of swimming pool.** For the purposes of this Subsection M (Cabaña), swimming pool is defined as a structure containing a body of water, whether above or below the ground, ~~having a minimum length, width and depth of 45 feet, eight feet, and 42 inches,~~

~~respectively~~, and which shall be designed for and used or intended to be used for swimming by individuals~~s~~. The following shall be excluded from this definition:

- a. Hot tubs, spas, including swim spas, and similar facilities.
- b. Ornamental ponds or water features, developed as landscape design features where swimming is not intended and does not occur.
- c. Portable, inflatable, and wading pools.

### **SECTION 9:**

DIVISION 35.7, Montecito Planning Permit Procedures, of Section 35-2, the Montecito Land Use and Development Code, of Chapter 35, Zoning, of the Santa Barbara County Code, Subsection F, Findings required for approval of Conditional Use Permits applications submitted in compliance with Chapter 35.438 (Sign Standards), of Section 35.472.060, Conditional Use Permits, of Chapter 35.472, Permit Review and Decisions, is hereby deleted in its entirety and the Section is re-lettered as appropriate.

### **SECTION 10:**

DIVISION 35.7, Montecito Planning Permit Procedures, of Section 35-2, the Montecito Land Use and Development Code, of Chapter 35, Zoning, of the Santa Barbara County Code, Section 35.472.130, Overall Sign Plans, of Chapter 35.472, Permit Review and Decisions, is hereby amended to read as follows:

- A. Purpose and intent.** This Section establishes procedures and findings for the approval of Overall Sign Plans to provide a method for an applicant to integrate the design and placement of signs within a project with the overall development design to achieve a unified appearance and that regulate signs located within a shopping center. The intent is to ensure that signs within a ~~shopping center~~ multi-nonresidential tenant development are visually attractive and are in a harmonious relationship to one another.
- B. Applicability.** ~~The provisions of this Section shall apply to all proposed signs located within shopping centers.~~
  - 1. Mandatory Overall Sign Plans.** An Overall Sign Plan is required for all proposed signs associated with developments with four or more nonresidential tenant spaces that will have individual signs.
  - 2. Optional Overall Sign Plans.** Overall Sign Plans are optional for signs associated with any other type of project.
- C. Allowed modifications.** The Montecito Planning Commission may allow the following sign modifications as part of the approval of an Overall Sign Plan:

1. **Freestanding signs.** An increase in the height, number and size limitations on freestanding signs.
  2. **Menu boards for drive-through restaurants.** An increase in the area limitation of menu boards.
  3. **Awning and Under canopy signs.** An increase in the area limitation of awning and under canopy signs.
  4. **Projecting and shingle signs.** An increase in the area limitation of projecting and shingle signs.
  5. **Wall sign.** An increase in the area limitation of wall signs.
- D. Contents of application.** An application for an Overall Sign Plan shall be submitted in compliance with Chapter 35.470 (Permit Application Filing and Processing).
- E. Processing.**
1. An application for an Overall Sign Plan shall be submitted concurrently with an application for a Development Plan for a development with four or more nonresidential tenant spaces that will have individual signs shopping center and shall be processed in conjunction with such Development Plan application, except as provided below.
    - a. An application for an Overall Sign Plan may be submitted independently if the Overall Sign Plan is for an existing development shopping center and the processing of a new or revised Development Plan is not required.
  2. **Review authority.**
    - a. The review authority for an Overall Sign Plan submitted concurrently with an application for a Development Plan shall be the review authority for the Development Plan.
    - b. The review authority for an application for an Overall Sign Plan submitted independent of a Development Plan in compliance with Subsection 1.a, above, and for projects that are not subject to Development Plan approval, shall be the Director.
  3. After receipt of an application for an Overall Sign Plan, the Department shall review the application in compliance with the requirements of the California Environmental Quality Act.
  - ~~4.3.~~ The Overall Sign Plan shall be subject to Design Review in compliance with Section 35.472.070 (Design Review).
    - ~~a. The Montecito Board of Architectural Review shall provide a recommendation to the Montecito Commission on:~~
      - ~~i. The effect of the proposed Overall Sign Plan on:  
(1) The various parts of and commercial enterprises within the shopping center.~~



- ~~(2) The streets and properties surrounding the shopping center.~~
  - ~~(3) The overall continuity of design and signs within the shopping center.~~
  - ~~ii. The number, type, height, location, size, design, color, materials, and lighting of signs contained within the Overall Sign Plan.~~
  - ~~b. If the area of menu boards for drive-through restaurants, under canopy signs, or wall signs, or the area, height, or number of freestanding signs is proposed to be in excess of that otherwise allowed in compliance with this Development Code, then the Montecito Board of Architectural Review shall make specific recommendations to the Montecito Commission on any such modification.~~
  - ~~4. The Montecito Commission shall hold at least one noticed public hearing on the requested Overall Sign Plan and approve, conditionally approve, or deny the request. The Montecito Commission shall consider the effect of the proposed Overall Sign Plan upon:~~
    - ~~a. The various parts of and commercial enterprises within the shopping center.~~
    - ~~b. The streets and properties surrounding the shopping center.~~
    - ~~c. The overall continuity of design and signs within the shopping center.~~
  - 5. Notice of the filing of an application and notice of review authority action hearing shall be given ~~and the hearing shall be conducted~~ in compliance with Chapter 35.496 (Noticing and Public Hearings).
    - a. In addition to mailed notice required in compliance with Chapter 35.496 (Noticing and Public Hearings) notice shall also be mailed a minimum of 10 days prior to the review authority action public hearing to all tenants within the development shopping center.
  - 6. The action of the review authority Montecito Commission is final subject to appeal in compliance with Chapter 35.492 (Appeals).
- F. Findings required for approval. An Overall Sign Plan application shall be approved or conditionally approved only if the review authority first makes all of the following findings:**
- 1. Findings for all Overall Sign Plans.**
    - a. The proposed project will be compatible with the neighborhood, and will not create an adverse impact to aesthetics, community character, or public views.
    - b. The proposed project will comply with all applicable requirements of this Development Code and the Comprehensive Plan, including any applicable community or area plan.
  - 2. Additional findings required for Overall Sign Plans that include modifications.** If an Overall Sign Plan includes any modifications in compliance with Subsection C (Allowed modifications) above, then the Overall Sign Plan application shall be approved or

conditionally approved only if the Montecito Commission first makes all of the following findings, as applicable:

**a1. Freestanding signs.** The proposed area, height, or number of freestanding signs is architecturally harmonious in relation to the size and location of the shopping center development.

**b2. Menu boards for drive-through restaurants.**

~~ia.~~ The proposed area of the menu board is architecturally harmonious in relation to the size and location of the structure on which it will be placed.

~~iib.~~ The proposed area of the menu board is architecturally harmonious in relation to the size and location of the area in which the structure is constructed.

**c3. Awning and ~~Under~~-canopy signs.** The proposed area of the awning or ~~under~~-canopy sign is architecturally harmonious in relation to the size and location of the building area occupied by the enterprise proposing the sign.

**d. Projecting and shingle signs.** The proposed area of the projecting or shingle sign is architecturally harmonious in relation to the size and location of the building area occupied by the enterprise proposing the sign.

**e4. Wall signs.**

~~ia.~~ The proposed area of the wall sign is architecturally harmonious in relation to the size and location of the structure on which it will be placed.

~~iib.~~ The proposed area of the wall sign is architecturally harmonious in relation to the size and location of the area on which the structure is constructed.

## **SECTION 11:**

DIVISION 35.7, Montecito Planning Permit Procedures, of Section 35-2, the Montecito Land Use and Development Code, of Chapter 35, Zoning, of the Santa Barbara County Code, Section 35.472.150, Sign Certificates of Conformance, of Chapter 35.472, Permit Review and Decisions is hereby amended to read as follows:

### **35.472.150 - Sign Certificates of Conformance**

**A. Purpose and intent.** This Section establishes procedures and findings for the approval of Sign Certificates of Conformance that are required in compliance with Chapter 35.438 (Sign Standards). The intent of this Section is to ensure that proposed signage is visually attractive and complies with the goals of the County.

**B. Applicability.** Before erecting, applying, installing, affixing, altering, relocating or projecting as an image any signage, a Sign Certificate of Conformance shall be issued unless identified as exempt from permit requirements by Chapter 35.438 (Sign Standards).

**C. Contents of application.** An application for a Sign Certificate of Compliance shall be submitted in compliance with Chapter 35.470 (Permit Application Filing and Processing).

**D. Processing.**

1. **Review for compliance.** The Director shall review the Sign Certificate of Conformance application for compliance with the Comprehensive Plan including the Montecito Community Plan, this Development Code, applicable Overall Sign Plan, and other applicable conditions and regulations, and shall approve, conditionally approve, or deny the request. A Sign Certificate of Conformance shall not be issued by the Director until all necessary prior approvals (e.g., Design Review, Overall Sign Plan) have first been obtained.

~~a. Signs located in shopping centers. A Sign Certificate of Compliance for a sign located within a shopping center shall not be issued by the Director unless the sign is determined to be in compliance with an approved Overall Sign Plan (Section 35.472.130 (Overall Sign Plans)).~~

2. **Decision not subject to appeal.** The action of the Director to issue, conditionally issue, or deny a Sign Certificate of Conformance is final and not subject to appeal ~~in compliance with Chapter 35.492 (Appeals).~~

~~**E. Findings required for approval.** A Sign Certificate of Conformance application shall be approved or conditionally approved only if the Director first makes all of the following findings:~~

~~1. The proposed signage is in compliance with Chapter 35.438 (Sign Standards).~~

~~2. The subject property is in compliance with all laws, regulations, and rules pertaining to zone uses, subdivisions, height requirements, setbacks, and any other applicable provisions of this Development Code, and any applicable zoning violation enforcement and processing fees have been paid.~~

**E.F. Permit expiration.** A Sign Certificate of Conformance shall remain valid only as long as compliance with all applicable requirements of this Development Code and the permit continues.

**SECTION 12:**

DIVISION 35.7, Montecito Planning Permit Procedures, of Section 35-2, the Montecito Land Use and Development Code, of Chapter 35, Zoning, of the Santa Barbara County Code, Section 35.472.160, Sign Modifications, of Chapter 35.472, Permit Review and Decisions, is hereby deleted in its entirety and reserved for future use.

**SECTION 13:**

DIVISION 35.9, Montecito Zones Land Use and Development Code Administration, of Section 35-2, the Montecito Land Use and Development Code, of Chapter 35, Zoning, of the Santa Barbara County Code, Section 35.498.020, Investigation, is hereby amended to read as follows:

**35.498.020 – Investigation**

The Director is hereby authorized to investigate all reported or apparent violations of any of the provisions of this Development Code. If a violation is determined to exist or to be impending, the Director is hereby authorized to take the measures as the Director deems necessary or expedient to enforce and secure compliance with the provisions of this Development Code.

**A. Cooperation of other officials.** The Director may request, and shall receive, the assistance and cooperation of other officials of the County to assist in the discharge of their duties.

**B. Right of entry and inspection.**

- 1. Director may enter any structure or premise.** With the consent of the owner or occupant, the Director may enter at all reasonable times any structure or premise in the County for the purpose of carrying out any act necessary to perform any duty imposed by this Development Code.
- 2. Provision of identification.** Upon request the Director shall provide adequate identification.
- 3. Use of inspection warrant.** An inspection warrant may be obtained if entry is refused.

**C. Liability.**

1. The Director or any other person charged with the enforcement of this Development Code, if acting in good faith and within the course and scope of their employment, shall not be liable personally, and is hereby relieved from all personal liability, for any damage that may accrue to persons or property as the result of, or by reason of, any act or omission occurring in the discharge of their duties.
2. Any suit brought against the Director, because of the act or omission performed in the enforcement of any provision of this Development Code, shall be defended by the County Counsel.

**D. Prima facie evidence of lodging.** Advertising that offers a property as a lodging, including a short-term rental or a homestay, shall constitute prima facie evidence of the operation of a lodging on the property. The burden of proof shall be on the owner, operator, or lessee of record to establish:

1. If the lodging has a valid permit in place, that the subject property is being operated consistent with the permits; or
2. If the lodging is not permitted, that the subject property is not being used as a lodging.

## **SECTION 14:**

DIVISION 35.10, Glossary, of Section 35-2, the Montecito Land Use and Development Code, of Chapter 35, Zoning, of the Santa Barbara County Code, Section 35.500.020, Definitions of Specialized Terms and Phrases, of Chapter 35.500, Definitions, is hereby amended to change the definitions of “Illegal Sign,” “Nonconforming Sign,” and “Sign,” to add a new definition of “Lighting,” and to delete the definitions of “Perimeter Lighting” and “Sign Structure” as follows:

**Illegal Sign.** A sign that includes any of the following:

1. A sign installed without complying with all regulations in effect at the time of its construction or use.
2. A sign installed or maintained contrary to ~~any applicable provision of~~ Chapter 35.438 (Sign Standards), ~~including a sign that was not removed at the end of an applicable amortization period.~~
3. A sign which is a danger to the public or is unsafe.
4. A sign which is a traffic hazard not created by relocation of streets or highways or by acts of the County.

**Lighting.** The method or equipment used to provide artificial illumination as used in Section 35.430.120 (Outdoor Lighting) of this Development Code. Lighting related terms include the following:

1. **Foot-candle.** The unit of measure expressing the quantity of light received on a surface. One foot-candle is equal to the amount of light generated by one candle shining on one square foot surface located one foot away.
2. **Fossil Fuel Light.** Light produced directly or indirectly by the combustion of natural gas or other utility- type fossil fuels, for example: gas, propane and kerosene lighting.
3. **Kelvin.** A unit of measure for color temperature. Kelvin is used in lighting to measure the color temperature of a light fixture. In short, the lower the Kelvin rating (expressed in K), the warmer the light. The higher the Kelvin rating, the colder and brighter the light.
4. **Lamp.** A generic term for a source of optical radiation (i.e. “light”), often called a “bulb” or “tube”. Examples include incandescent, fluorescent, high-intensity discharge (HID) lamps, and low pressure sodium (LPS) lamps, as well as light-emitting diode (LED) modules and arrays.
5. **Light Fixture.** Complete lighting unit consisting of lamp(s) and ballast(s) (when applicable) together with the parts designed to distribute the light (reflector, lens, diffuser) and any shields to position and protect the lamps, and to connect the lamps to the power source.

**Full Cutoff.** A light fixture constructed and mounted such that the luminous intensity (in candelas) at or above an angle of 90° above nadir is zero, and the luminous intensity (in

candelas) at or above a vertical angle of 80° above nadir does not numerically exceed 10 percent of the luminous flux (in lumens) of the lamp or lamps in the lighting fixture.

**Full Cutoff Light Fixture**

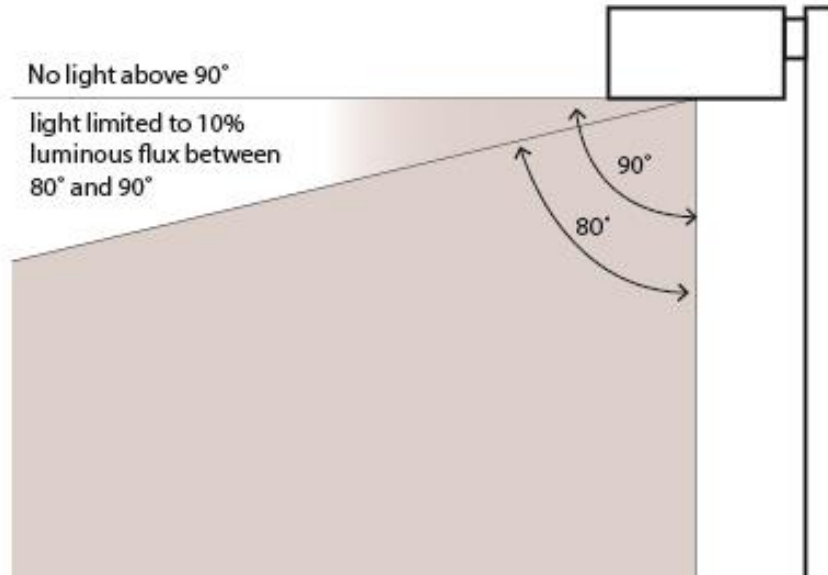

**Fully Shielded.** A light fixture constructed and mounted such that the luminous intensity (in candelas) at or above an angle of 90° above nadir is zero.

**Fully Shielded Light Fixture**

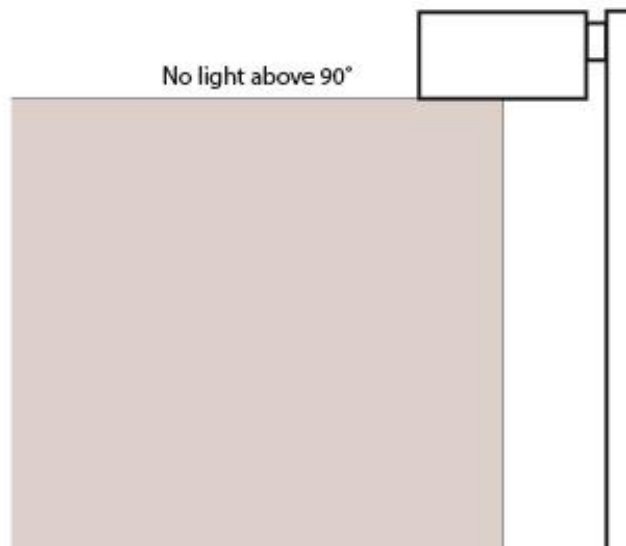

**Partially shielded.** A light fixture constructed and mounted such that most light emitted by the fixture is projected below the horizontal. A partially shielded light fixture may allow some light to pass through a semi-translucent barrier, and/or may allow visibility of the lamp from certain perspectives.

**Partially Shielded Light Fixture**

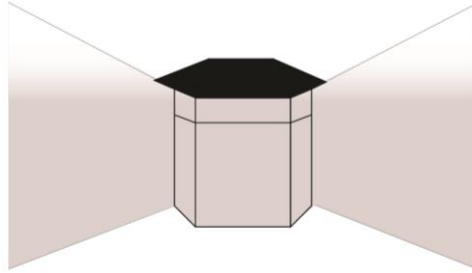

6. **Light Pollution.** Artificial light which causes a detrimental effect on the environment, astronomical research, enjoyment of the night sky or causes undesirable glare or light trespass.
7. **Light Shielding.** A barrier around a lamp or light fixture that conceals or partially conceals the lamp and controls light distribution.
8. **Light Trespass.** Light that falls beyond the property line of the property on which the light fixture is located.
9. **Lumen.** Unit of luminous flux; used to measure the amount of light emitted by a lamp.
10. **Uplighting.** Light radiating above the horizontal plane.

**Nonconforming Sign.** An advertising structure or sign which was lawfully erected and maintained prior to the adoption of this Development Code, but does not now completely comply with current regulations, ~~provided that the applicable amortization period has not expired.~~

~~**Perimeter Lighting.** A subdued method of illuminating a sign without illuminating the area outside of the sign, see Figure 10-2 (Perimeter Lighting).~~

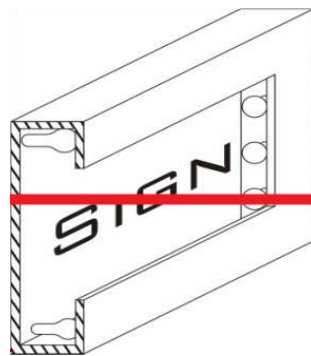
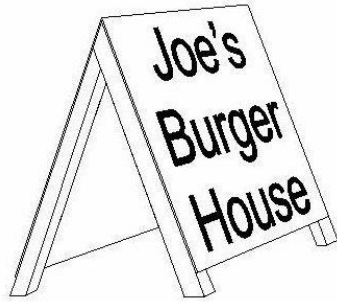

**Figure 10-2—Perimeter Lighting**

**Sign.** A structure, device, figure, display, message placard, or other contrivance, or any part thereof, situated outdoors or indoors, which is designed, constructed, intended, or used to advertise, or to otherwise provide information, to direct or attract attention to an object, person, institution, business, product, service, event, or location by any means, including words, letters,

figures, designs, symbols, fixtures, colors, illumination, or projected images. Does not include murals, paintings and other works of art that are not intended to advertise or identify any business or product. Types of signs and sign related terms include the following:

1. **A-Board Sign.** A portable "a-frame" or "sandwich board" sign, see Figure 10-~~23~~ - A-Board Sign, below.



**Figure 10-~~23~~ – A-Board Sign**

2. **Abandoned Sign.** A sign that no longer advertises a business, lessor, owner, product, service or activity on the premises where the sign is displayed.
3. **Animated or Moving Sign.** A sign which uses movement, lighting, or special materials to depict action or create a special effect to imitate movement.
- ~~4. **Arcade Sign.** A sign located on the exterior of an arcade facing the street which does not extend above or below the arcade structure.~~
- ~~4.5. **Awning Sign.** A sign ~~copy or logo attached to or painted~~ placed on an awning, see Figure 10-3 - Awning Sign, below.~~

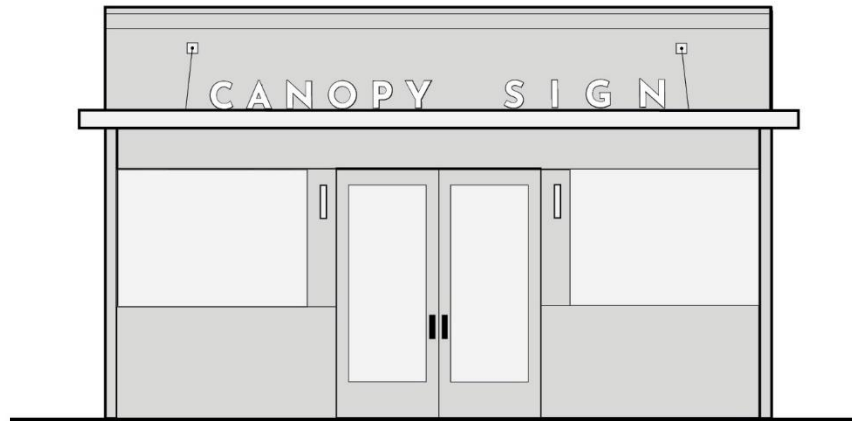

**Figure 10-3 – Awning Sign**



**5.6. Banner, Flag, or Pennant.** Cloth, bunting, plastic, paper, or similar non-rigid material used for advertising purposes attached to a structure, staff, pole, line, framing, or vehicle, ~~not including official flags of the United States, the State of California, and other states of the nation, counties, municipalities, official flags of foreign nations and nationally or internationally recognized non-commercial organizations.~~

**6. Canopy Sign.** A sign placed on a canopy, see Figure 10-4 - Canopy Sign.



**Figure 10-4 – Canopy Sign**

**7. Commercial Message.** A message on a sign, or portion of a sign, that promotes, informs, or proposes economic transaction, primarily concerns the economic interests of the sign sponsor and/or audience, or is intended to further discussion in the marketplace of goods and services.

**8. Copy.** Also called “sign copy.” The visually communicative elements mounted on a sign.

~~**7. Bench Sign.** Copy painted on a portion of a bench.~~

~~**8. Business Sign or Structure.** Any sign or structure designed, intended or used for advertising the particular business, product or service located or sold on the same premises as that on which the sign or structure is located.~~

**9. Cabinet (Can) Sign.** A sign with its text and/or logo symbols and artwork on a translucent face panel that is mounted within a metal frame or cabinet that contains the lighting fixtures which illuminate the sign face from behind.

~~**10. Changeable Copy Sign.** A sign designed to allow the changing of copy through manual, mechanical, or electrical means including time and temperature.~~

~~**11. Combination Farm Sign.** A sign used for the purpose of identifying the owner or operator of a farm and the product produced on the farm, which sign may also incidentally identify the contract buyer of the product (e.g., Calavo).~~

- 10.12. Construction Sign.** A temporary sign placed at a construction site that provides information regarding the project architect, owner, contractors, etc.
- 11.13. Directional and Informational Sign.** A sign that is designed and erected solely for the purposes of directing vehicular and/or pedestrian circulation traffic within a project site.
- ~~14. Directory Sign. A sign for listing the tenants and their suite numbers of a multiple tenant structure or center.~~
- 12.15. Double-Faced Sign.** A sign constructed to display its message on the outer surfaces of two ~~identical and/or~~ opposite ~~parallel~~ planes ~~located within 24 inches of each other.~~
- ~~16. Educational Sign. A sign located in a public park and along trails and walkways that provides facts and information about the natural environment (e.g., names and origins of plants; names of animals and descriptions of their habitat and behavior; names and characteristics of geological features).~~
- 13.17. Electronic Message Center Reader Board Sign.** A sign with a fixed or changing display formed by the selective illumination of an array of light bulbs, light emitting diodes (LEDs), or liquid crystal displays (LCDs) that can be changed electronically ~~composed of a series of lights, but not including time and temperature displays.~~
- ~~18. Farm Organization Sign. A sign used only for the purpose of indicating membership in a farm organization, such as Cattlemen's Association, 4-H Club, Farm Bureau.~~
- 14. Flag.** Any fabric or banner containing distinctive colors, patterns, or design that displays the symbol(s) of a nation, state, local government, company, organization, belief system, idea, or other meaning.
- 15.19. Flashing Sign.** An animated sign that contains an intermittent or sequential flashing light source.
- 16.20. Freestanding Sign.** A sign fixed in an upright position on the ground not attached to a structure other than a framework, pole, braces, solid base, or other device, erected primarily to support the sign, see Figure 10-5 - Freestanding Signs, below. ~~Includes monument signs and pole signs and the following:~~
- ~~a. Entrance/Exit Sign. A sign containing only the words "entrance" or "exit."~~
  - ~~b. Gate or Entrance Sign. A sign attached to an entrance gate or entrance structure to a residential building site or residential subdivision which identifies the site or subdivision.~~
  - ~~c. Identification Sign. A sign used only for the purpose of identifying the occupancy of a building, structure, or property.~~
  - ~~d. Monument Sign. An independent, freestanding structure supported on the ground having a solid base as opposed to being supported by poles or open braces.~~

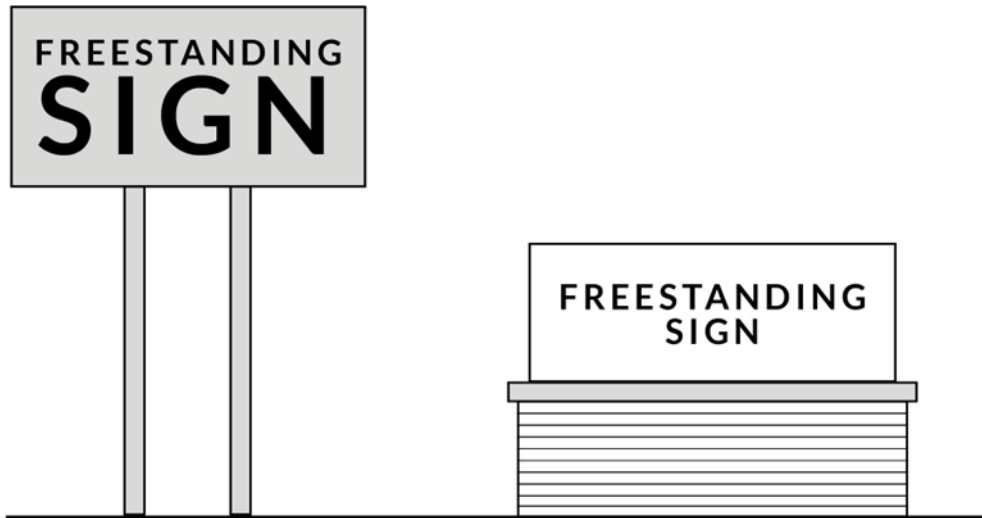

**Figure 10-5 – Freestanding Signs**

**17.21. Indirectly Illuminated Sign.** A sign whose light source is external to the sign and which casts its light onto the sign from a distance; or where the light source is behind an opaque sign element and causes the opaque element to be outlined by light reflected from the surface to which the sign is mounted.

**18.22. Institutional Sign.** A sign used only for the purpose of identifying an established organization or foundation, typically of a public character (e.g., school, hospital, museum, lodge).

**19.23. Internally Illuminated Sign.** A sign whose light source is located in the interior of the sign so that light passes through the face of the sign, or light source which is attached to the face of the sign and is perceived as a design element of the sign.

**24. Marquee (Canopy) Sign.** ~~A sign attached to or constructed in a marquee.~~

**20.25. Menu Board Sign.** A sign that is either affixed to a wall or freestanding, which may be illuminated, which indicates information that is essential for the efficient intake of orders from customers of a drive-through ~~restaurant~~ facility.

**21. Mobile Billboard.** Any vehicle, or wheeled conveyance which carries, conveys, pulls, displays, or transports any sign or billboard for the primary purpose of advertising a commercial or noncommercial message.

**22. Non-Commercial Message.** A message or image on a sign that directs public attention to or advocates an idea or issue of public interest or concern that does not serve to advertise or promote any business, product, activity, service, interest, or entertainment.

**26. Multi-Tenant Sign.** See "Directory Sign."

~~27. Multiple Copy Sign. A sign which advertises other than the name of the business and principal product or service. See Figure 10-4 – Multiple Copy Sign, below.~~

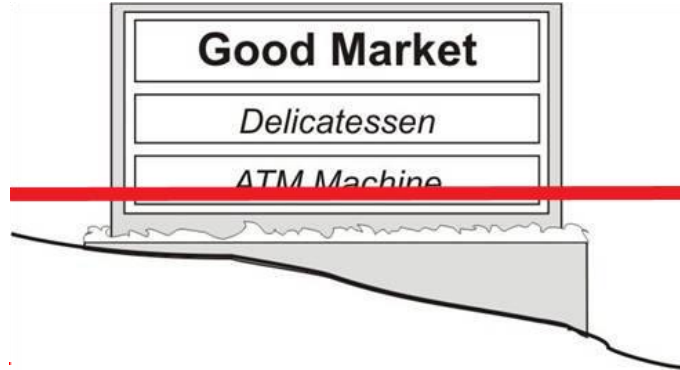

**Figure 10-4 – Multiple Copy Sign**

~~23.28. Onsite Sign. A sign containing copy relating only to the business, product, service, or activity conducted or sold on the same premises as that on which the sign is located. Sometimes also known as "business sign."~~

~~24.29. Permanent Sign. A sign constructed of durable materials and intended to exist for an indefinite period of time the duration of time that the use or occupant is located on the premises.~~

~~25.30. Political or Social Issue Sign. A sign that addresses:~~

- ~~a. The passage or defeat of a measure appearing on the ballot in any national, state, or local election;~~
- ~~b. The election or defeat of any candidate for any public office in any national, state, or local election; or~~
- ~~c. An international, national, state, or local political or social issue.~~

~~31. Pole/Pylon Sign. An elevated freestanding sign typically supported by one or two poles or columns.~~

~~26.32. Portable Sign. A sign that is not permanently affixed to a structure or the ground.~~

~~27.33. Projecting Sign. A sign that projects horizontally from the face of a building, see Figure 10-6 - Projecting Signs, below. mounted on the façade or vertical surface of a structure in such a manner that all of the display surfaces are not parallel to the supporting surface.~~

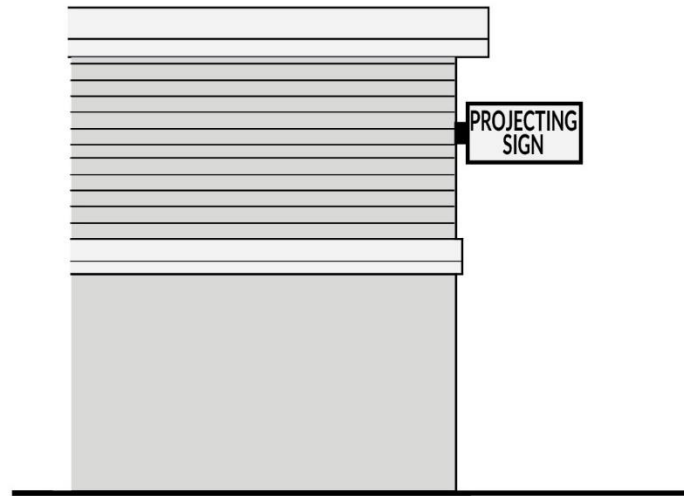

**Figure 10-6 – Projecting Signs**

**28.34. Real Estate Sign.** A sign indicating that a property or any portion thereof is available for inspection, sale, lease, rent, or directing people to a property, but not including temporary subdivision signs.

**29.35. Roof Sign.** A sign constructed upon or over a roof, or placed so as to extend above the edge of the roof, see Figure 10-7 - Roof Signs, below. Signs mounted on parapet walls are not considered roof signs. Signs which are on pylons or other architectural projections and extend **more than six inches** above a roof or parapet wall are, for the purpose of this Development Code, roof signs.

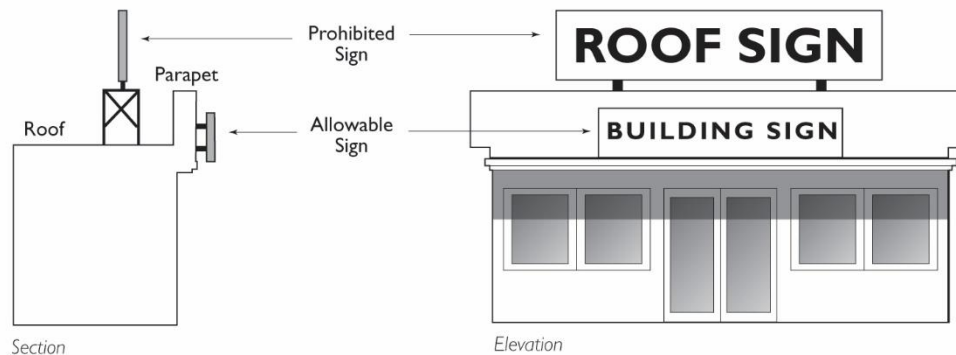
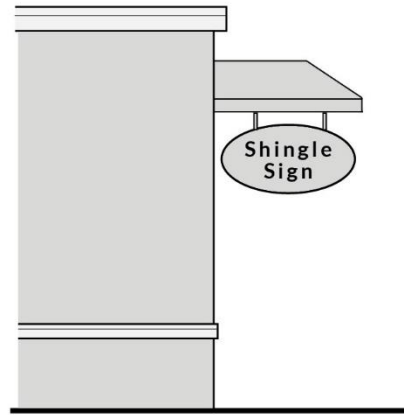

**Figure 10-7 – Roof Signs**

**30.36. Safety Sign.** A sign warning of hazards.

~~37. **Security Sign.** A sign used for the purpose of indicating the presence of security devices, use of surveillance cameras for security purposes, or electronic warning systems.~~

~~31. **Shingle Sign.** A sign that is suspended beneath a marquee, covered walkway, canopy, or awning, see Figure 10-8 - Shingle Sign, below.~~



**Figure 10-8- Shingle Sign**

~~32. **Sign Area.** The area contained within a single continuous perimeter enclosing all parts of such sign copy, excluding any structural elements outside the limits of the sign required to support the sign.~~

~~33. **Sign Face.** An exterior display surface of a sign, including non-structural trim, exclusive of the supporting structure. The area of a sign which is available for mounting and public display of the visually communicative image.~~

~~38. **Subdivision Directional Sign.** A sign that provides directions to a new subdivision with onsite model homes and/or sales office, where lots and/or housing units are, or will be for sale.~~

~~34. **Sign Structure.** A structure that supports or is capable of supporting any sign as defined in this Code.~~

~~35.39. **Temporary Sign.** A temporary sign intended to be displayed for a limited period of time and capable of being viewed from a public right-of-way, parking area or neighboring property.~~

~~40. **Time and/or Temperature Sign.** See "Changeable Copy Sign."~~

~~41. **Trail Marker Sign.** A sign designed and intended to mark a public trail/path system used by equestrians, pedestrians, and cyclists using non-motorized vehicles.~~

~~42. **Under Canopy Sign.** A sign attached to the underside of a canopy.~~

~~43. Vehicle Sign. A sign which is attached to or painted on a vehicle which is parked onsite or off-site, the principal purpose of which is to attract attention to a product sold or business.~~

**36.44. Wall Sign.** A sign affixed in any manner to any exterior wall of a building and which is parallel to and projects not more than 18 inches from the building wall and which does not extend more than six inches above the parapet wall or roof of the building on which it is located. Signs which are on architectural projections which do not extend more than six inches above the roof or parapet wall of the building are, for the purpose of this Development Code, wall signs.

**37.45. Window Sign.** A sign posted, painted, placed, or affixed in or on a window, or located within 12 inches from the inside of a window, in a manner that it can be viewed from the exterior of the structure exposed to public view.

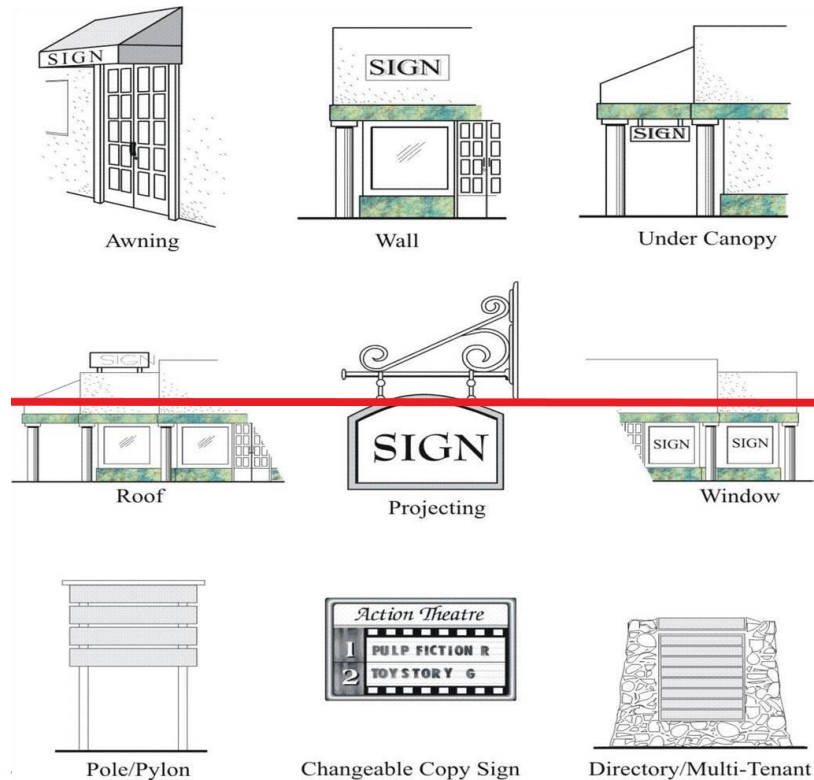

**Figure 10-5—Sign Examples**

~~Sign Structure. A structure that supports or is capable of supporting any sign as defined in this Development Code.~~

**SECTION 15:**

All existing indices, section references and numbering, and figure and table numbers contained in Section 35-2, the Montecito Land Use and Development Code, of Chapter 35, Zoning, of the

Santa Barbara County Code, are hereby revised and renumbered as appropriate to reflect the revisions enumerated above.

**SECTION 16:**

Except as amended by this ordinance, Section 35-2, the Montecito Land Use and Development Code, of Chapter 35, Zoning, of the Santa Barbara County Code, shall remain unchanged and shall continue in full force and effect.

**SECTION 17:**

If any section, subsection, sentence, clause, or phrase of this ordinance is for any reason held to be invalid, such decision shall not affect the validity of the remaining portions of this ordinance. The Board of Supervisors hereby declares that it would have passed this ordinance and each section, subsection, sentence, clause, and phrase thereof, irrespective of the fact that nay one or more sections, subsections, sentences, clauses, or phrases be declared invalid.

**SECTION 18:**

If legislation is enacted which would supersede or preempt any section or subsection of this ordinance then the Board of Supervisors deems that section or subsection null and void and this ordinance shall remain in full force and effect without said section or subsection.

**SECTION 19:**

This ordinance shall take effect and be in force 30 days from the date of its passage and before the expiration of 15 days after its passage a summary of it shall be published once together with the names of the members of the Board of Supervisors voting for and against the same in a newspaper of general circulation published in the County of Santa Barbara.

PASSED, APPROVED, AND ADOPTED by the Board of Supervisors of the County of Santa Barbara, State of California, this \_\_\_\_\_ day of \_\_\_\_\_, 2024, by the following vote:

AYES:

NOES:

ABSTAIN:

ABSENT:



\_\_\_\_\_  
STEVE LAVAGNINO, CHAIR  
BOARD OF SUPERVISORS  
COUNTY OF SANTA BARBARA

ATTEST:

MONA MIYASATO, COUNTY EXECUTIVE OFFICER  
CLERK OF THE BOARD

By \_\_\_\_\_  
Deputy Clerk

APPROVED AS TO FORM:

RACHEL VAN MULLEM  
COUNTY COUNSEL

By \_\_\_\_\_  
Deputy County Counsel

ATTACHMENT D: 24ORD-00003 RESOLUTION

RESOLUTION OF THE MONTECITO PLANNING COMMISSION  
COUNTY OF SANTA BARBARA, STATE OF CALIFORNIA

IN THE MATTER OF RECOMMENDING THAT THE )  
COUNTY PLANNING COMMISSION RECOMMEND )  
THAT THE BOARD OF SUPERVISORS ADOPT AN )  
ORDINANCE AMENDING CHAPTER 35, ZONING, OF )  
THE COUNTY CODE BY REPEALING ARTICLE I, SIGN )  
REGULATIONS, AND AMENDING ARTICLE II, )  
COASTAL ZONING ORDINANCE, BY AMENDING )  
DIVISION 2, DEFINITIONS, DIVISION 4, ZONING )  
DISTRICTS, DIVISION 5, OVERLAY DISTRICTS, )  
DIVISION 7, GENERAL REGULATIONS, DIVISION 11, )  
PERMIT PROCEDURES, DIVISION 12, )  
ADMINISTRATION, DIVISION 13, SUMMERLAND )  
COMMUNITY PLAN OVERLAY, DIVISION 14, )  
GOLETA COMMUNITY PLAN AND EASTERN )  
GOLETA VALLEY COMMUNITY PLAN OVERLAY )  
DISTRICTS, AND DIVISION 17, GAVIOTA COAST )  
PLAN (GAV) OVERLAY, TO IMPLEMENT NEW )  
REGULATIONS AND DEVELOPMENT STANDARDS )  
REGARDING OUTDOOR LIGHTING, SIGNS, AND )  
SIGN STRUCTURES, AND MAKE OTHER )  
MISCELLANEOUS CHANGES.

RESOLUTION NO.: 24- 11

CASE NO.: 24ORD-00003

**WHEREAS**, on April 27, 1970, by Ordinance 2077, the Board of Supervisors (Board) adopted Article I, Sign Regulations, of Chapter 35, Zoning, of the Santa Barbara County Code; and

**WHEREAS**, on July 19, 1982, by Ordinance 3312, the Board adopted Article II, the Coastal Zoning Ordinance, of Chapter 35, Zoning, of the Santa Barbara County Code; and

**WHEREAS**, Section 35-139 of Article II, the Coastal Zoning Ordinance, contains regulations on outdoor lighting within the Coastal Zone generally, and Sections 35-191.9, 35-192.3, 35-212, and 35-440.D contain regulations on outdoor lighting for the Summerland Community Plan area, Eastern Goleta Valley Community Plan area, Montecito Community Plan area, and Gaviota Coast Community Plan area, respectively; and

**WHEREAS**, Article I, Sign Regulations, contains regulations on signs and sign structures within the Coastal Zone; and

**WHEREAS**, Article II, the Coastal Zoning Ordinance, does not contain regulations on signs, sign structures, or permitting procedures for signs and sign structures; and

**WHEREAS**, Article II, the Coastal Zoning Ordinance, contains many regulations and standards, and periodic updates are needed to clarify and modernize portions of the code; and

**WHEREAS**, the Montecito Planning Commission now finds that it is in the interest of the orderly development of the County and important to the preservation of health, safety, and general welfare of the residents of the County, to recommend that the County Planning Commission recommend that the Board adopt an ordinance (Case No. 24ORD-00003) repealing Article I, Sign Regulations, of Chapter 35,

Zoning, of the Santa Barbara County Code; and amending Division 2, Definitions; Division 4, Zoning Districts; Division 5, Overlay Districts; Division 7, General Regulations; Division 11, Permit Procedures; Division 12, Administration; Division 13, Summerland Community Plan Overlay; Division 14, Goleta Community Plan and Eastern Goleta Valley Community Plan Overlay Districts; and Division 17, Gaviota Coast Plan (GAV) Overlay; of Article II, the Coastal Zoning Ordinance, of Chapter 35, Zoning, of the Santa Barbara County Code to implement new regulations regarding outdoor lighting and signs and make other miscellaneous changes regarding setbacks and pool cabañas in compliance with Government Code Sections 65852.2 and 65852.22; and

**WHEREAS**, the proposed Coastal Zoning Ordinance amendment is attached hereto as Attachment D-1 and is incorporated herein by reference; and

**WHEREAS**, the proposed Coastal Zoning Ordinance amendment is consistent with the Coastal Act of 1976, the Santa Barbara County Coastal Land Use Plan, the County Comprehensive Plan, including the Montecito Community Plan, and the requirements of State planning, zoning, and development laws; and

**WHEREAS**, the proposed Coastal Zoning Ordinance amendment is in the interest of the general community welfare since it will provide for orderly development within the Montecito Community Plan Area, reduce light trespass and light pollution, and clarify requirements for signs, outdoor lighting, and other sections of the Coastal Zoning Ordinance; and

**WHEREAS**, the Montecito Planning Commission has held duly noticed public hearings on August 21, 2024, and September 18, 2024, in compliance with Government Code Section 65854, on the proposed Coastal Zoning Ordinance amendment at which hearing the proposed amendment was explained and comments invited from the persons in attendance.

**NOW, THEREFORE, IT IS HEREBY RESOLVED** as follows:

1. The above recitations are true and correct.
2. In compliance with the provisions of Government Code Section 65855, the Montecito Planning Commission recommends that the County Planning Commission recommend that the Board of Supervisors of the County of Santa Barbara, State of California, following the required noticed public hearing, approve and adopt the above-mentioned recommendation of this Montecito Planning Commission, based on the findings included as Attachment A of the Montecito Planning Commission staff memorandum dated September 10, 2024, and with the following revisions recommended by the Montecito Planning Commission at the September 18, 2024, hearing:
  - a. Allow for uplighting of specimen trees and the U.S. flag with a cumulative limit of 500 lumens;
  - b. Require that string lights installed outside of landscaping be hooded;
  - c. Clarify that the 60-day limit for seasonal lighting shall be usage of the lights, not placement; and
  - d. Require that lights shall not be directed towards the ocean.
3. A certified copy of this Resolution shall be transmitted to the County Planning Commission in compliance with Government Code Section 65855 and County Code Section 2-25.2.
4. The Chair of the Montecito Planning Commission is hereby authorized and directed to sign and certify all documents and other materials in accordance with this Resolution to reflect the above mentioned action by the Montecito Planning Commission.

Outdoor Lighting, Signs, and Miscellaneous Ordinance Amendments  
Montecito Planning Commission  
Hearing Date: September 18, 2024  
Attachment D – Page 3

PASSED, APPROVED, AND ADOPTED this 18<sup>th</sup> day of September, 2024 by the following vote:

AYES: Miller, Senauer, Pulice, Stahl

NOES:

ABSENT: Kupiec

ABSTENTIONS:

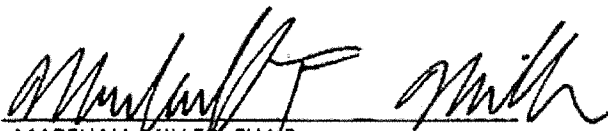
  
\_\_\_\_\_  
MARSHALL MILLER, CHAIR  
SANTA BARBARA COUNTY  
MONTECITO PLANNING COMMISSION

ATTEST:

JEFF WILSON  
SECRETARY TO THE COMMISSION

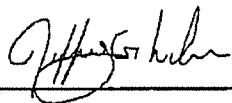
By   
\_\_\_\_\_

APPROVED AS TO FORM:

RACHEL VAN MULLEM  
COUNTY COUNSEL

By   
\_\_\_\_\_  
DEPUTY COUNTY COUNSEL

Attachment D-1: Article II Ordinance Amendment, Case No. 24ORD-00003

G:\GROUP\COMP\Ordinances\Outdoor Lighting and Signs\Public Hearings\MPC\9-18 Memo\ATT D 24ORD-00003 CZO Resolution.doc

**ATTACHMENT D-1: COASTAL ZONING ORDINANCE  
ORDINANCE AMENDMENT**

**ORDINANCE NO. \_\_\_\_\_**

AN ORDINANCE REPEALING ARTICLE I, SIGN REGULATIONS, OF CHAPTER 35, ZONING, OF THE SANTA BARBARA COUNTY CODE, AND AMENDING ARTICLE II, COASTAL ZONING ORDINANCE, OF CHAPTER 35, ZONING, OF THE SANTA BARBARA COUNTY CODE, BY AMENDING DIVISION 2, DEFINITIONS; DIVISION 4, ZONING DISTRICTS; DIVISION 5, OVERLAY DISTRICTS; DIVISION 7, GENERAL REGULATIONS; DIVISION 11, PERMIT PROCEDURES; DIVISION 12, ADMINISTRATION; DIVISION 13, SUMMERLAND COMMUNITY PLAN OVERLAY; DIVISION 14, GOLETA COMMUNITY PLAN AND EASTERN GOLETA VALLEY COMMUNITY PLAN OVERLAY DISTRICTS; AND DIVISION 17, GAVIOTA COAST PLAN (GAV) OVERLAY, TO IMPLEMENT NEW REGULATIONS AND DEVELOPMENT STANDARDS REGARDING OUTDOOR LIGHTING, SIGNS, AND SIGN STRUCTURES, AND MAKE OTHER MISCELLANEOUS CHANGES.

Case No. 24ORD-00003

The Board of Supervisors of the County of Santa Barbara, State of California, ordains as follows:

**SECTION 1:**

Article I, Sign Regulations, Divisions 1 through 9, of Chapter 35, Zoning, of the Santa Barbara County Code, is hereby deleted in its entirety and reserved for future use.

**SECTION 2:**

DIVISION 2, Definitions, of Article II, the Coastal Zoning Ordinance, of Chapter 35, Zoning, of the Santa Barbara County Code, Section 35-58, Definitions, is hereby amended to change the definitions of "Lighting," to add the definitions of "Illegal Sign," "Nonconforming Sign," and "Sign", and to delete the definition of "Business Sign or Structure" to read as follows:

**Section 35-58. – Definitions**

~~**Business Sign or Structure:** Any sign or structure designed, intended or used for advertising the particular business, product or service located or sold on the same premises as that on which the sign or structure is located.~~

~~**Illegal Sign.** A sign that includes any of the following:~~

- ~~1. A sign installed without complying with all regulations in effect at the time of its construction or use.~~
- ~~2. A sign installed or maintained contrary to Section 35.138 (Sign Standards).~~

3. A sign which is a danger to the public or is unsafe.
4. A sign which is a traffic hazard not created by relocation of streets or highways or by acts of the County.

**Lighting.** The method or equipment used to provide artificial illumination as used in Section 35-~~139191.10~~ (Exterior Lighting) of this Article. ~~Types of lighting~~ Lighting related terms include the following:

- ~~1. Downward Directional Light. Direction of light downward, rather than upward or outward, with the intention of directing light where it is needed. Downward lighting also prevents unnecessary and unwanted spillover of light to adjacent areas and properties.~~
1. Foot-candle. The unit of measure expressing the quantity of light received on a surface. One foot-candle is equal to the amount of light generated by one candle shining on one square foot surface located one foot away.
2. **Fossil Fuel Light.** Light produced directly or indirectly by the combustion of natural gas or other utility- type fossil fuels, for example: gas, propane and kerosene lighting.
- ~~3. High Intensity Discharge Lamp. High pressure sodium, mercury vapor, metal halide, low pressure sodium, and other similar lamps.~~
3. Kelvin. A unit of measure for color temperature. Kelvin is used in lighting to measure the color temperature of a light fixture. In short, the lower the Kelvin rating (expressed in K), the warmer the light. The higher the Kelvin rating, the colder and brighter the light.
4. Lamp. A generic term for a source of optical radiation (i.e. “light”), often called a “bulb” or “tube”. Examples include incandescent, fluorescent, high-intensity discharge (HID) lamps, and low pressure sodium (LPS) lamps, as well as light-emitting diode (LED) modules and arrays.
5. Light Fixture. Complete lighting unit consisting of lamp(s) and ballast(s) (when applicable) together with the parts designed to distribute the light (reflector, lens, diffuser) and any shields to position and protect the lamps, and to connect the lamps to the power source.

**Full Cutoff.** A light fixture constructed and mounted such that the luminous intensity (in candelas) at or above an angle of 90° above nadir is zero, and the luminous intensity (in candelas) at or above a vertical angle of 80° above nadir does not numerically exceed 10 percent of the luminous flux (in lumens) of the lamp or lamps in the lighting fixture.

#### **Full Cutoff Light Fixture**

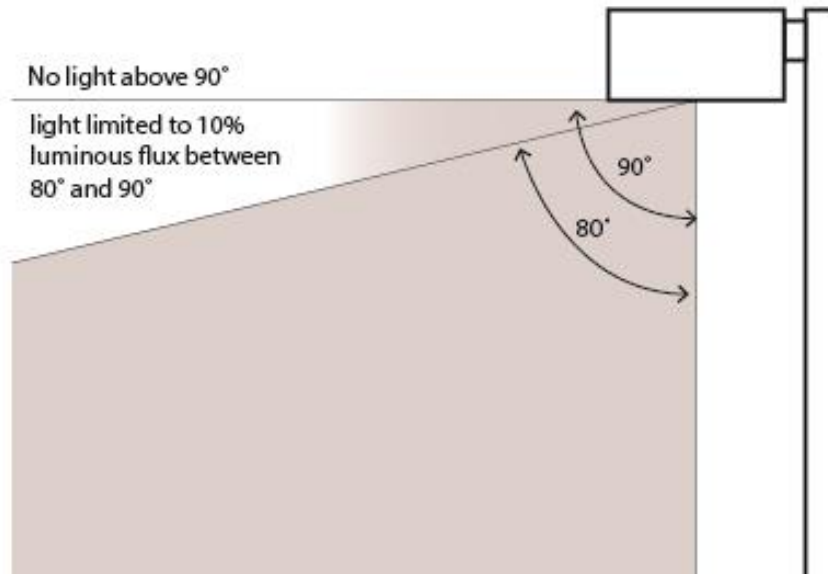

**Fully Shielded.** A light fixture constructed and mounted such that the luminous intensity (in candelas) at or above an angle of 90° above nadir is zero.

**Fully Shielded Light Fixture**

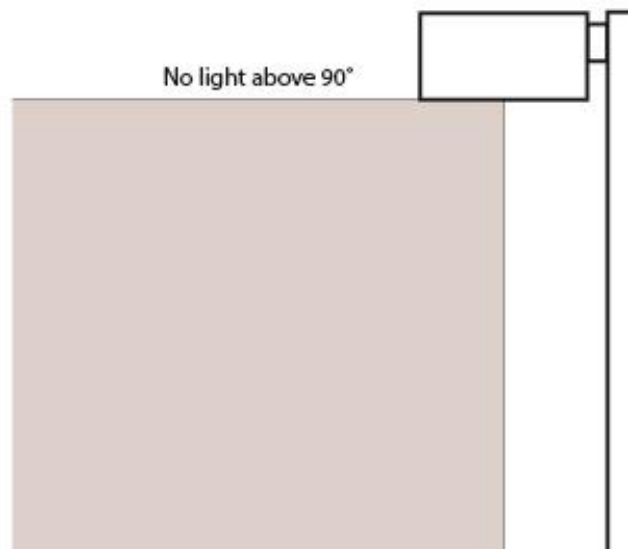

**Partially shielded.** A light fixture constructed and mounted such that most light emitted by the fixture is projected below the horizontal. A partially shielded light fixture may allow some light to pass through a semi-translucent barrier, and/or may allow visibility of the lamp from certain perspectives.

**Partially Shielded Light Fixture**

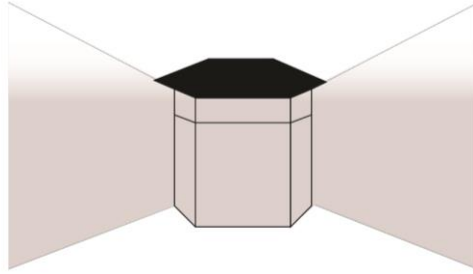

- ~~4. Luminous Tube Light. Gas filled glass tubing which when subjected to high voltage becomes luminescent in a color characteristic of the gas used (neon, argon, etc.).~~
- ~~5. Outdoor Light Fixture. Artificial illuminating devices, outdoor fixtures, lamps and other similar devices, permanently installed or portable, exterior to or in the absence of a structure, used for flood lighting, general illumination or advertisement. Such devices include outdoor lighting for:
  - ~~Billboards and other signs~~
  - ~~Buildings and structures~~
  - ~~Landscape lighting~~
  - ~~Parking lots~~
  - ~~Sports and Outdoor Recreational facilities~~
  - ~~Street lighting~~
  - ~~Walkway lighting~~~~
- 6. Light Pollution.** Artificial light which causes a detrimental effect on the environment, astronomical research, enjoyment of the night sky or causes undesirable glare or light trespass.
- 7. Light Shielding.** A barrier around a lamp or light fixture that conceals or partially conceals the lamp and controls light distribution. ~~Types of light shielding include the following:~~
  - ~~1. Fully Shielded (full cutoff). Outdoor light fixtures with a solid barrier that emit no light rays above the horizontal plane and effectively obscure the visibility of a lamp.~~



**Fully Shielded (full cutoff) Light Fixtures**

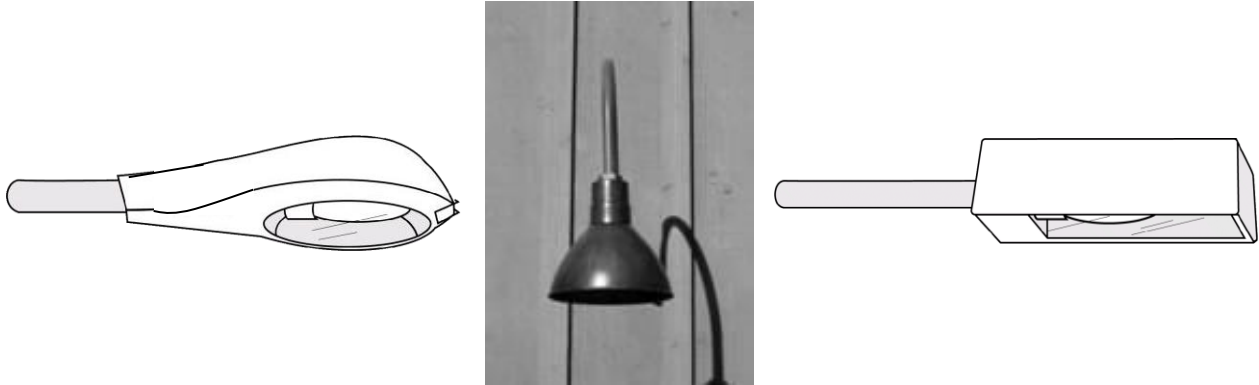

~~2. **Partially Shielded Light.** An outdoor light fixture that may allow some light to pass through a semi-translucent barrier, and/or may allow visibility of the lamp from certain perspectives.~~



~~3. **Unshielded Light.** An outdoor light fixture lacking means to restrict light emitted above the horizontal plane.~~

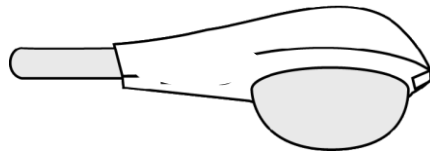

~~8. **Light Trespass.** Light that falls beyond the property line of the property on which the light fixture is located. Artificial light that produces unnecessary and/or unwanted illumination offsite including skyward or on a sensitive habitat.~~

~~9. **Lumen.** Unit of luminous flux; used to measure the amount of light emitted by a lamp.~~

~~10. **Uplighting.** Light radiating above the horizontal plane.~~

**Nonconforming Sign.** An advertising structure or sign which was lawfully erected and maintained prior to the adoption of this Development Code, but does not now completely comply with current regulations.

**Sign.** A structure, device, figure, display, message placard, or other contrivance, or any part thereof, situated outdoors or indoors, which is designed, constructed, intended, or used to advertise, or to otherwise provide information, to direct or attract attention to an object, person, institution, business, product, service, event, or location by any means, including words, letters, figures, designs, symbols, fixtures, colors, illumination, or projected images. Does not include murals, paintings and other works of art that are not intended to advertise or identify any business or product. Types of signs and sign related terms include the following:

**1. A-Board Sign.** A portable "a-frame" or "sandwich board" sign, see figure below.

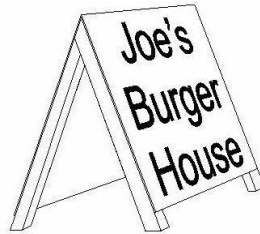

**A-Board Sign**

**2. Abandoned Sign.** A sign that no longer advertises a business, lessor, owner, product, service or activity on the premises where the sign is displayed.

**3. Animated or Moving Sign.** A sign which uses movement, lighting, or special materials to depict action or create a special effect to imitate movement.

**4. Awning Sign.** A sign placed on an awning, see figure below.

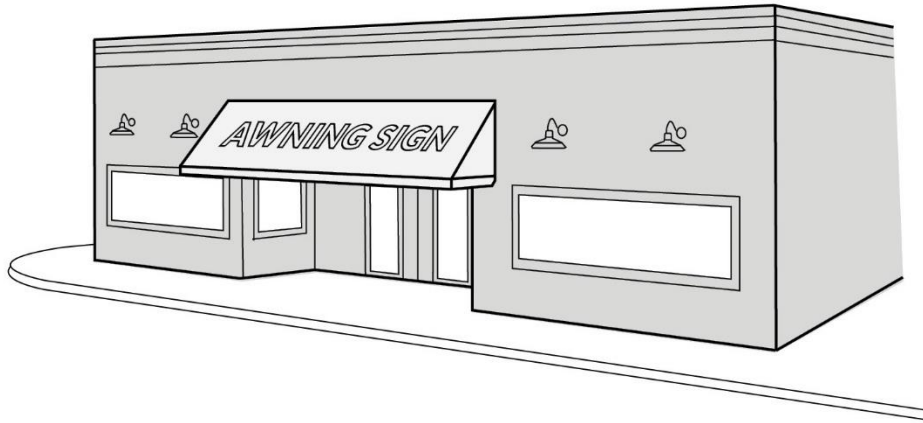

---

**Awning Sign**

**5. Banner or Pennant.** Cloth, bunting, plastic, paper, or similar non-rigid material used for advertising purposes attached to a structure, staff, pole, line, framing, or vehicle.

**6. Canopy Sign.** A sign placed on a canopy, see figure below.



---

**Canopy Sign**

**7. Commercial Message.** A message on a sign, or portion of a sign, that promotes, informs, or proposes economic transaction, primarily concerns the economic interests of the sign sponsor and/or audience, or is intended to further discussion in the marketplace of goods and services.

- 8. Copy.** Also called “sign copy.” The visually communicative elements mounted on a sign.
- 9. Changeable Copy Sign.** A sign designed to allow the changing of copy through manual, mechanical, or electrical means including, but not limited to, time and temperature.
- 10. Construction Sign.** A temporary sign placed at a construction site that provides information regarding the project architect, owner, contractors, etc.
- 11. Directional Sign.** A sign that is designed and erected solely for the purposes of directing vehicular and/or pedestrian circulation within a project site.
- 12. Double-Faced Sign.** A sign constructed to display its message on the outer surfaces of two opposite planes.
- 13. Electronic Message Center Sign.** A sign with a fixed or changing display formed by the selective illumination of an array of light bulbs, light emitting diodes (LEDs), or liquid crystal displays (LCDs) that can be changed electronically.
- 14. Flag.** Any fabric or banner containing distinctive colors, patterns, or design that displays the symbol(s) of a nation, state, local government, company, organization, belief system, idea, or other meaning.
- 15. Flashing Sign.** An animated sign that contains an intermittent or sequential flashing light source.
- 16. Freestanding Sign.** A sign fixed in an upright position on the ground not attached to a structure other than a framework, pole, braces, solid base, or other device, erected primarily to support the sign.

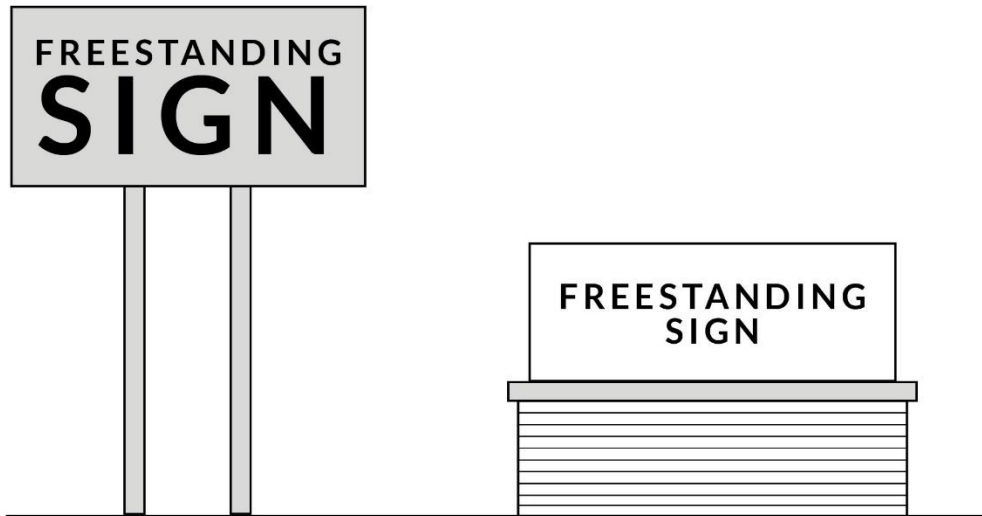

---

### Freestanding Signs

- 17. Indirectly Illuminated Sign.** A sign whose light source is external to the sign and which casts its light onto the sign from a distance; or where the light source is behind an opaque sign element and causes the opaque element to be outlined by light reflected from the surface to which the sign is mounted.
- 18. Institutional Sign.** A sign used only for the purpose of identifying an established organization or foundation, typically of a public character (e.g., school, hospital, museum, lodge).
- 19. Internally Illuminated Sign.** A sign whose light source is located in the interior of the sign so that light passes through the face of the sign, or light source which is attached to the face of the sign and is perceived as a design element of the sign.
- 20. Menu Board Sign.** A sign that is either affixed to a wall or freestanding, which may be illuminated, which indicates information that is essential for the efficient intake of orders from customers of a drive-through facility.
- 21. Mobile Billboard.** Any vehicle, or wheeled conveyance which carries, conveys, pulls, displays, or transports any sign or billboard for the primary purpose of advertising a commercial or noncommercial message.
- 22. Non-Commercial Message.** A message or image on a sign that directs public attention to or advocates an idea or issue of public interest or concern that does not serve to advertise or promote any business, product, activity, service, interest, or entertainment.
- 23. Off-Site Directional Sign.** A sign providing directions to another location.

**24. Off-Site Sign.** A sign identifying a use, facility, service, or product that is not located, sold, or manufactured on the same premises that the sign is located on.

**25. Onsite Sign.** A sign containing copy relating only to the business, product, service, or activity conducted or sold on the same premises as that on which the sign is located.

**26. Permanent Sign.** A sign constructed of durable materials and intended to exist for an indefinite period of time.

**27. Political or Social Issue Sign.** A sign that addresses:

- a. The passage or defeat of a measure appearing on the ballot in any national, state, or local election;
- b. The election or defeat of any candidate for any public office in any national, state, or local election; or
- c. An international, national, state, or local political or social issue.

**28. Portable Sign.** A sign that is not permanently affixed to a structure or the ground.

**29. Projecting Sign.** A sign that projects horizontally from the face of a building, see figure below.

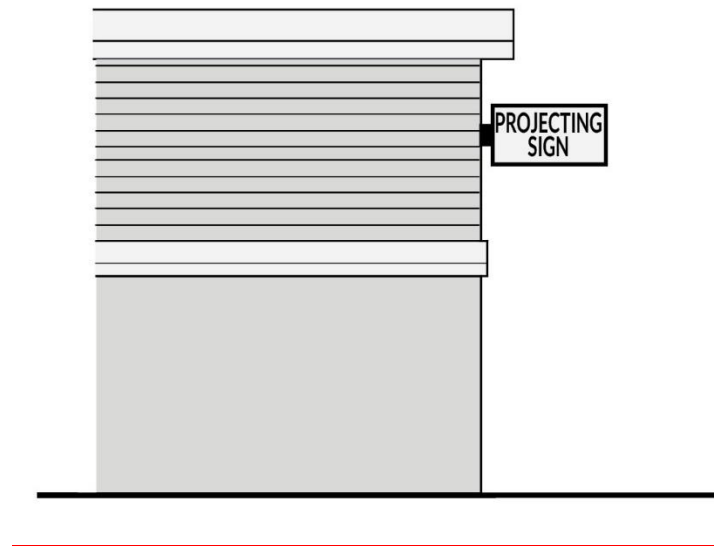

**Projecting Sign**

**30. Real Estate Sign.** A sign indicating that a property or any portion thereof is available for inspection, sale, lease, rent, or directing people to a property, but not including temporary subdivision signs.

**31. Roof Sign.** A sign constructed upon or over a roof, or placed so as to extend above the edge of the roof, see figure below. Signs mounted on parapet walls are not considered roof signs. Signs which are on pylons or other architectural projections and extend above a roof or parapet wall are, for the purpose of this Development Code, roof signs.

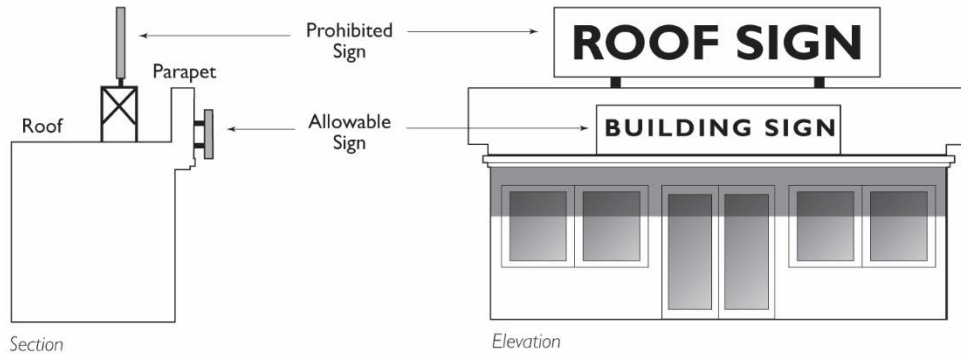

---

**Roof Sign**

**32. Safety Sign.** A sign warning of hazards.

**33. Shingle Sign.** A sign that is suspended beneath a marquee, covered walkway, canopy, or awning, see figure below.

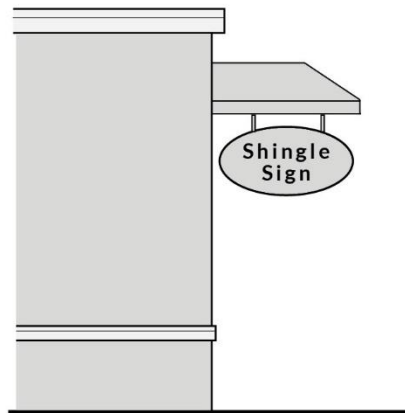

---

**Shingle Sign**

**34. Sign Area.** The area contained within a single continuous perimeter enclosing all parts of such sign copy, excluding any structural elements outside the limits of the sign required to support the sign.

**35. Sign Face.** An exterior display surface of a sign, including non-structural trim, exclusive of the supporting structure. The area of a sign which is available for mounting and public display of the visually communicative image.

**36. Sign Structure.** A structure that supports or is capable of supporting any sign as defined in this Development Code.

**37. Temporary Sign.** A temporary sign intended to be displayed for a limited period of time and capable of being viewed from a public right-of-way, parking area or neighboring property.

**38. Wall Sign.** A sign affixed in any manner to any exterior wall of a building and which is parallel to and projects not more than 18 inches from the building wall and which does not extend more than six inches above the parapet wall or roof of the building on which it is located. Signs which are on architectural projections which do not extend more than six inches above the roof or parapet wall of the building are, for the purpose of this Development Code, wall signs.

**39. Window Sign.** A sign posted, painted, placed, or affixed in or on a window, or located within 12 inches from the inside of a window, in a manner that it can be viewed from the exterior of the structure, see figure below.



**Window Sign**

**SECTION 3:**

DIVISION 4, Zoning Districts, of Article II, the Coastal Zoning Ordinance, of Chapter 35, Zoning, of the Santa Barbara County Code, Section 35-71.8, Permitted Variations of Setbacks for Buildings, of Section 35.71, R-1/E-1 – Single-Family Residential, is amended to read as follows:

**Section 35-71.8 Permitted Variations of Setbacks for Buildings**

- 1. Side.** The required side setback for portions of a building, including attached and detached accessory structures, may be varied subject to all of the following limitations. See Figure 4-1



(Variable Side Setback).

- a. No portion of the building shall be less than five feet from the side lines of the lot.
- b. No portion of an exterior wall of a building containing non-fixed windows or doors opening into rooms of a building (except a garage or other non-habitable space) shall be located closer to the side lines of a lot than the required side setback prior to any variation allowed by subsection c. below.
- c. A portion of a building may be located within the required side setback provided that the footprint area of the portion of the structure that intrudes into the required side setback, combined with the footprint area of any other portions of the structure that currently intrude into the required side setback, shall be compensated by an equal or greater area that is not covered by any building footprint area located outside of and adjacent to the same side setback and the side setback line without any intervening obstruction. The compensating area used to vary a side setback shall be located adjacent to the side setback line that is being varied, outside of the required rear and front setback areas, and shall not be located farther from the portion of the building intruding into the setback area adjacent side lot line than one-half of the lot ~~width~~ depth.
- d. The compensating area used to vary a side setback shall not be used to vary a rear setback on the same lot.

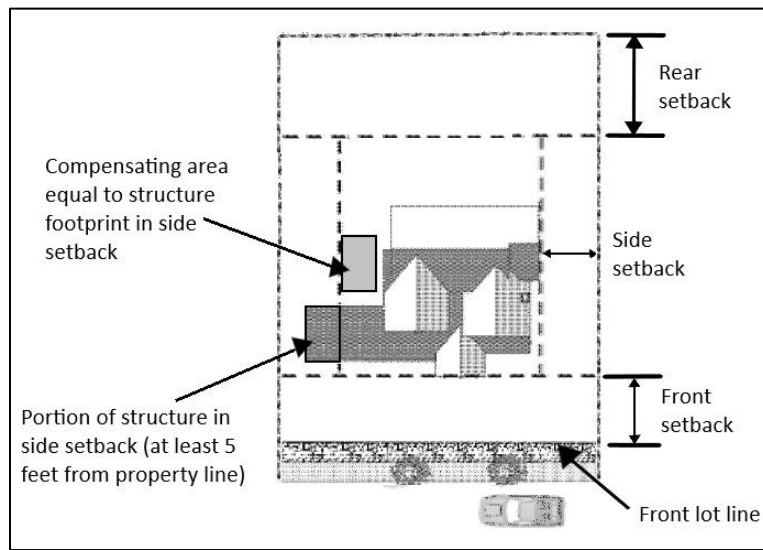

**Figure 4-1 – Variable Side Setback**

2. **Rear.** The required rear yard setback for a portion of a building, including attached and detached accessory structures, may be varied subject to all of the following limitations. See Figure 4-2 (Variable Rear Setback).
  - a. No portion of a building ~~used for dwelling purposes~~ shall be closer than 15 feet to the rear line of the lot.

- b. A portion of a building may be located within the required rear setback, combined with the footprint area of any other portions of the structure that intrude into the required rear setback, shall be compensated by an equal or greater area that is not covered by any footprint area located outside of and adjacent to the rear setback and the rear setback line without any intervening obstruction. The compensating area used to vary a rear setback shall be located outside the required side setback areas and shall not be located farther from the portion of the building intruding into the setback area rear lot line than one-half of the lot depth width.
- c. The compensating area used to vary a rear setback shall not be used to vary a side setback on the same lot.

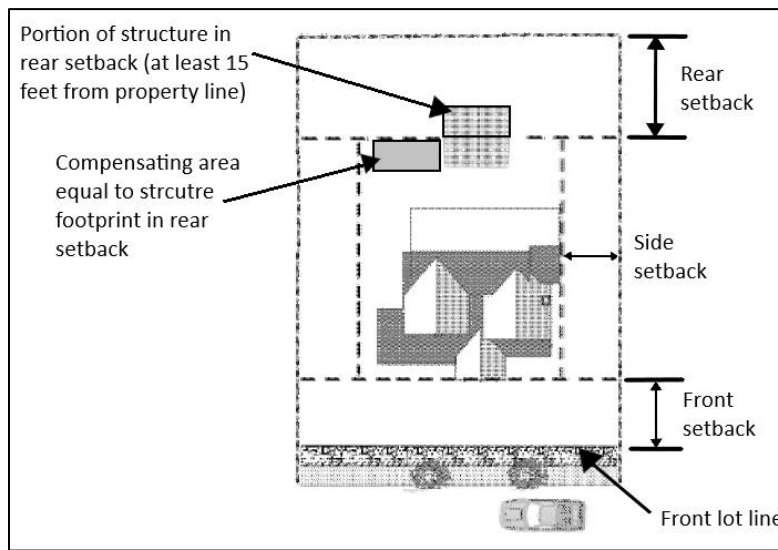

**Figure 4-2 – Variable Rear Setback**

**SECTION 4:**

DIVISION 5, Overlay Districts, of Article II, the Coastal Zoning Ordinance, of Chapter 35, Zoning, of the Santa Barbara County Code, Subsection B, Applicability, of Section 35-102G, CVC – Critical Viewshed Corridor Overlay District, is amended to read as follows:

- B. Applicability.** This overlay district is applied in the Gaviota Coast Plan area to the visually critical near-field viewsheds located to the north and south of Highway 101 as shown on the Gaviota Coast Plan Zoning Overlay map. All development within this overlay district is subject to the requirements of this overlay district except as provided below:
1. Single agricultural structures with an individual gross floor area of less than 5,000 square feet are not subject to the requirements of this overlay zone provided:

- a. The existing cumulative structural development located on the lot that the structure is proposed to be located on does not exceed a footprint area of 10,000 square feet.
- b. The structure(s) complies with the following standards:
  - 1) All exterior lighting is in compliance with the following:
    - a) The lighting is required for safety purposes only.
    - b) ~~Exterior lighting complies with Section 35-139 (Exterior Lighting). Light fixtures are fully shielded (full cutoff and are directed downward to minimize impacts to the rural nighttime character.~~
    - c) Lighting is directed away from habitat areas and, to the extent feasible, nearby residences, public roads and other areas of public use.
  - (2) The structure uses building materials, earth tone colors, and non-reflective paints that are compatible with the surrounding natural environment to maximize the visual compatibility of the development with surrounding areas.

#### **SECTION 5:**

DIVISION 7, General Regulations, of Article II, the Coastal Zoning Ordinance, of Chapter 35, Zoning, of the Santa Barbara County Code, Subsection 4 of Section 35-119, Accessory Structures, is hereby amended to read as follows:

4. Except as provided in Subsection 4.a (Accessory dwelling units and junior accessory dwelling units), below, accessory structures shall conform to the height requirements and the front and side yard setback regulations of the district. An detached accessory structure may be located in the required rear yard setback provided that it is located no closer than 10 feet to the principal structure, ~~and that it occupies no more than~~ the cumulative footprint of all accessory structures, including accessory dwelling units, that encroach into the setback does not exceed 40 percent of the required rear yard, and that it does not exceed a height of 12 feet.
  - a. **Accessory dwelling units and junior accessory dwelling units.**
    - 1) See Section 35-142 (Accessory Dwelling Units and Junior Accessory Dwelling Units) for height limits for accessory dwelling units and junior accessory dwelling units.
    - 2) An accessory dwelling unit may be located in the required rear setback only when allowed in compliance with Section 35-142 (Accessory Dwelling Units and Junior Accessory Dwelling Units).

#### **SECTION 6:**

DIVISION 7, General Regulations, of Article II, the Coastal Zoning Ordinance, of Chapter 35,

Zoning, of the Santa Barbara County Code, Subsection 12, Cabaña, of Section 35-120, Guest House, Artist Studio, or Pool House/Cabaña, is hereby amended to read as follows:

**Section 35-120. – Guest House, Artist Studio, or Pool House/Cabaña.**

**12. Cabaña.** A cabaña may be approved as an accessory structure provided that its use is accessory to a sports court or swimming pool, or is located on a lot located directly adjacent to the sea.

**a. Definition of swimming pool.** For the purposes of this Subsection 12 (Cabaña), swimming pool is defined as any open structure containing a body of water, whether above or below the ground, ~~having a minimum length, width and depth of 45 feet, eight feet and 42 inches, respectively, and~~ which shall be designed for and used or intended to be used for swimming by individuals. The following shall be excluded from this definition:

- 1) Hot tubs, spas, including swim spas, and similar facilities.
- 2) Ornamental ponds or water features, developed as landscape design features where swimming is not intended and does not occur.
- 3) Portable, inflatable, and wading pools.

**b. Restrictions on use.** The cabaña may be maintained and used as a cabaña provided that the sports court or swimming pool that the cabaña is accessory to is also maintained and used on the lot. If the sports court or swimming pool to which the cabaña is accessory to is abandoned or removed, then the use of the cabaña shall cease and the cabaña shall either be removed or lawfully converted to an allowed accessory structure within 90 days following the abandonment or removal of the sports court or swimming pool.

**c. Sequence of construction.** A cabaña may be approved in conjunction with a proposed swimming pool or sports court provided that construction of the proposed swimming pool or sports court is completed before or simultaneously with completion of the cabaña.

**SECTION 7:**

DIVISION 7, General Regulations of Article II, the Coastal Zoning Ordinance, of Chapter 35, Zoning, of the Santa Barbara County Code, Subsection a of Subsection 4 of Section 35-125, General Setback Regulations, is hereby amended to read as follows:

- a. The ordinary projection of sills, buttresses, cornices, chimneys, eaves, outdoor stairways, and ornamental features may extend into a setback no more than three feet. Handrails on outdoor stairways may extend into the setback an additional six inches.

**SECTION 8:**

DIVISION 7, General Regulations of Article II, the Coastal Zoning Ordinance, of Chapter 35, Zoning, of the Santa Barbara County Code, Subsection 3, Interior Lots, of Section 35-126, Through, Corner, Interior, and Odd Shaped Lots, is hereby amended to read as follows:

3. **Interior Lots.** The setback regulations of the applicable zone district shall not apply to an interior lot but any structure located upon such lot shall have a setback of at least 10 feet from all property lines and the total setback area shall equal the total area of all setbacks required in the applicable zone district. Where no setback is required by the applicable zone, a setback of 10 feet shall not be required.

**SECTION 9:**

DIVISION 7, General Regulations, of Article II, the Coastal Zoning Ordinance, of Chapter 35, Zoning, of the Santa Barbara County Code, Section 35-138, Signs and Advertising Structures, is hereby amended to read as follows:

**Section 35-138. – Signs and Advertising Structures.**

~~Except as provided below, signs and advertising structures are regulated by Article 1 of this Chapter 35 of the Code of Santa Barbara County and any amendments thereto.~~

**Section 35-138.1 Purpose.**

The purpose of this Section is to promote the public health, safety, and welfare through a comprehensive system of reasonable, effective, consistent, content-neutral, and nondiscriminatory sign standards and requirements. More specifically, this Section is intended to:

- A. Balance public and private objectives by allowing adequate avenues for both commercial and non-commercial messages;
- B. Allow signs to serve as an effective channel of communication while preventing visual clutter that will detract from the aesthetic character of the County;
- C. Maintain and enhance the County’s appearance by regulating the location, number, type, quality of materials, size, illumination, and maintenance of signs;
- D. Restrict signs that may create a nuisance to nearby properties, violate privacy, or create hazards or unreasonable distractions for pedestrians or drivers;
- E. Provide clear and unambiguous sign standards that enable fair and consistent enforcement; and
- F. Ensure that the constitutionally guaranteed right of free speech is protected.

See “Sign” within Section 35-58 (Definitions) for definitions related to signage as used within this Section.

### **Section 35-138.2 Applicability.**

The provisions of this Section apply to all signs in all zones, erected, constructed or physically altered on or after the effective date of the Ordinance amending this Section, unless otherwise specified.

- A. Message Neutrality.** It is the County’s policy and intent to regulate signs in a manner consistent with the U.S. and California constitutions, which is content neutral as to non-commercial speech and does not favor commercial speech over non-commercial speech.
- B. Registered Mark.** The provisions of this Section shall not require alteration of the display of any registered mark, trademark, service mark, trade name, or corporate name that may be associated with or incorporated into a registered mark, where such alteration would require the registered mark to be displayed in a manner differing from the mark as exhibited in the certificate of registration issued by the United States Patent and Trademark Office. It is the responsibility of the applicant to establish that a proposed sign includes a registered mark.
- C. Noncommercial Signs.** Non-commercial signs are allowed wherever commercial signage is permitted and are subject to the same standards and total maximum allowances per site or building of each sign type specified in this Section. For purposes of this Section, all non-commercial speech messages are deemed to be “on-site,” regardless of location.

### **Section 35-138.3 Exemptions.**

Except when a Coastal Development Permit is required in compliance with Subsection B of Section 35-138.8., the following signs are exempt from the permit requirements of Section 35-138 (Signs and Advertising Structures), do not count towards the maximum number of signs or maximum sign area, and may be located in setback areas, provided that they are erected on an allowed and, where applicable, permitted, structure and conform to the specified standards.

- A. Address Signs.** Required address identification signs that are in conformance with the Building Code.
- B. Commercial Displays on Vehicles.** Displays that are part of the vehicle and related to the goods or services provided by the vehicle owner or operator and public transit/public carrier graphics on properly licensed buses, taxicabs, and similar vehicles for hire that legally pass through the County.
- C. Construction Signs.** Nonilluminated construction informational signs not to exceed eight square feet per site, erected after the required permits for the construction have been obtained and removed prior to final inspection.

- D. Directional Signs.** Non-illuminated directional signs not more than eight square feet in area or four feet in height for the direction of the public such as outlining/assisting vehicle and pedestrian circulation within a site, to ingress and egress, and to facilities such as restrooms, telephones, walkways, and other similar features.
- E. Flags.** Flags that do not display a commercial message.
- F. Gas Pump Signs.** Signs on or within five feet of a gas pump.
- G. Government Signs.** Signs and devices erected by a governmental entity, including, but not limited to, Santa Barbara County and public schools.
- H. Historic Plaques and Commemorative Signs.** Historic plaques, memorial signs or tablets, or commemorative signs indicating names of buildings and dates of building erection, either attached to or cut into the surfaces of buildings, with a maximum allowable sign area of four square feet per sign.
- I. Informational Signs.** Informational signs not more than two square feet in area indicating information such as hours and days of operation, whether a business is open or closed, payment information, crop identification, and emergency address and telephone numbers.
- J. Interior Signs.** Signs that are in the interior areas of a building and at least 12 inches from a window, door, or other exterior wall opening.
- K. Manufacturer’s Mark.** Manufacturer’s marks, including signs on items such as vending machines, gas pumps, and ice containers with a maximum allowable sign area of four square feet per sign.
- L. Nameplate.** One nameplate for each tenant or occupant not to exceed two square feet in area indicating the name of the occupant or tenant.
- M. No Trespassing Signs.** “No Trespassing” signs not more than one square foot in area and located a minimum of 50 feet from any other “No Trespassing” sign or in compliance with the requirements of law.
- N. Official and Safety Signs.** Official notices issued by a court, public body, or office and posted in the performance of a public duty; safety and other notices posted by a utility or other quasi-public agency; signs erected by a governmental body to direct or regulate pedestrian or vehicular traffic; non-commercial bus stop signs erected by a public transit agency, or other signs required for safety or authorized by law.
- O. Open House Directional Signs.** Up to four off-site signs directing the public to "open house" events for the viewing of lots, premises, dwellings or structures that are for sale, lease, or rent, are permitted on private land, provided they comply with the following standards:
  - 1. No sign or signs exceeds four square feet in area, or three feet in height from finished grade.**

2. The sign or signs may not be placed more than two hours before the start or remain more than two hours after the conclusion of the open house event.

**P. Political, Social Issue, and Other Noncommercial Signs.** Signs informing of political candidates, parties, issues, measures, propositions, philosophies or personal beliefs, and which are not commercial messages, shall be exempt from all regulations of Section 35-138 (Signs and Advertising Structures), except that such signs shall not be placed within the public right-of-way. Political signs shall conform to the requirements of the California State Code for placement and removal.

**Q. Real Estate Signs.** One nonilluminated, on-site sign pertaining to the sale, lease, or rental of a structure or land, not exceeding six square feet in a Residential Zone or 25 square feet in any zone other than a Residential Zone.

**R. Subdivision Signs.** The following signs are allowed on the site of a subdivision of five or more lots where a Tentative Map has been approved by the County.

1. One nonilluminated, on-site sign per street frontage with a maximum size of 32 square feet per sign is allowed for a maximum of one-year period.

2. One nonilluminated lot identification sign per undeveloped lot containing only the subdivision lot number, with a maximum size of one square foot, is allowed until the subject lot is sold.

**S. Temporary Signs.**

1. **Temporary Window Signs.** Temporary window signs not exceeding four square feet or 15 percent of the window area, whichever is greater, displayed for a maximum of 30 consecutive days.

2. **Temporary Event Balloons, Inflatable Signs, Streamers, Pennants and Other Attention-Getting Devices.** Balloons, banners, inflatable signs, streamers, pennants, and other attention-getting devices associated with a temporary event. The balloons, inflatable signs, streamers, pennants, and other attention-getting devices shall be erected no more than five days prior to the associated temporary event and shall be removed within 24 hours after the end of the associated temporary event.

3. **Other Temporary Signs.** Other temporary signs, including garage and yard sale signs, not exceeding six square feet displayed for a maximum of 30 consecutive days. A maximum of two temporary signs may be displayed at the same time on a single site. Temporary garage and yard sale signs may be located off-site in the public right-of-way for a maximum of 24 hours before and 24 hours after the subject sale.

**Section 35-138.4 Prohibitions.**



Unless otherwise permitted by a specific provision of Section 35-138 (Signs and Advertising Structures), the following sign types are prohibited:

- A. Animated or Moving Signs.** Animated, flashing, blinking, reflecting, revolving, or other similar sign with visibly moving or rotating elements or visible mechanical movement of any kind except when integrated into a gas pump.
- B. Balloons, Inflatable Signs, Streamers, Pennants and Other Attention-Getting Devices.** Balloons, inflatable signs, streamers, pennants, and other attention-getting devices, made of light-weight fabric or similar material, designed to rotate or move with the wind, that direct, promote, or that are otherwise designed to attract attention.
- C. Mobile Billboards.** Any sign carried or conveyed by a vehicle for the primary purpose of general advertising for hire. This prohibition eliminates mobile billboard advertising within the County to reduce traffic congestion, promote the safe movement of vehicular traffic, to reduce air pollution, and improve the aesthetic appearance of the County. This prohibition does not apply to displays that are part of the vehicle and related to the goods or services provided by the vehicle owner or operator or to public transit/public carrier graphics on properly licensed buses, taxicabs, and similar vehicles for hire that legally pass through the County.
- D. Off-Site Signs.** Any sign advertising any activity, business, product, or service that are not conducted on the premises upon which the sign is located.
- E. Roof Signs.** Signs constructed upon or over a roof; placed on a rooftop structure such as penthouse walls, chimneys, or mechanical enclosures; or placed so as to extend above the roofline or parapet.
- F. Signs Located in the Public Right-of-Way or on Public Property.** Other than official government signs or warning signs required by law, no inanimate sign may be placed in or project into the public right-of-way or on public property unless authorized by an encroachment permit.
- G. Signs Affixed to Trees.** Signs affixed to or cut into trees or other living vegetation.
- H. Signs on Terrain.** Signs cut, burned, marked, or displayed in any manner on a street, sidewalk, cliff, hillside, or other terrain feature.
- I. Signs Creating Traffic or Pedestrian Safety Hazards.** Signs placed, located, or displayed in such a manner as to constitute a traffic or pedestrian safety hazard. This includes, but is not limited to:
  - 1. Signs that obstruct use of any door, window, or fire escape.
  - 2. Signs that impede normal pedestrian use of public sidewalks. A minimum unobstructed width of four feet must always be maintained.

3. Signs that constitute a traffic hazard or obstruct the view of traffic, any authorized traffic sign, or signal device.
  4. Signs that create confusion or conflict with any authorized traffic sign or signal device due to color, location, wording, or use of specific phrases, symbols, or characters.
- J. Signs Producing Noise or Emissions.** Signs producing visible smoke, vapor, particles, odor, noise, or sounds that can be heard at the property line shall be prohibited. This prohibition excludes menu boards with voice units at Drive-Through Facilities and signs erected for public safety, including, but not limited to, pedestrian crossing signs.
- K. Signs for Prohibited Uses.** A sign displaying a commercial message promoting a business that is a prohibited use and has not been established as a legal nonconforming use.
- L. Signs Deterring Public Access.** A sign intended to deter public access to or along tidelands, shorelines, beaches and public waterways, public trails, public parks, public open space, or public access easements to any of the locations listed in this subsection M., except where such signs are necessary for public safety, minimization of erosion, or protection of an Environmentally Sensitive Habitat.
- M. Unauthorized Signs.** Signs shall not be placed on private or public property without the permission of the property owner.

### **Section 35-138.5 Sign Measurement.**

- A. Measuring Sign Area.** The area of a sign face includes the entire area within the perimeter of a maximum of two squares and/or rectangles that enclose the extreme limits of the frame or outline of the sign copy, or where there is no frame or outline, letters, pictures, symbols, logos, artwork, emblems, color, or other details conveying a message. Supporting structures, such as sign bases and columns, are not included in sign area provided that they contain no lettering or graphics. The area of an individual sign shall be calculated as follows.

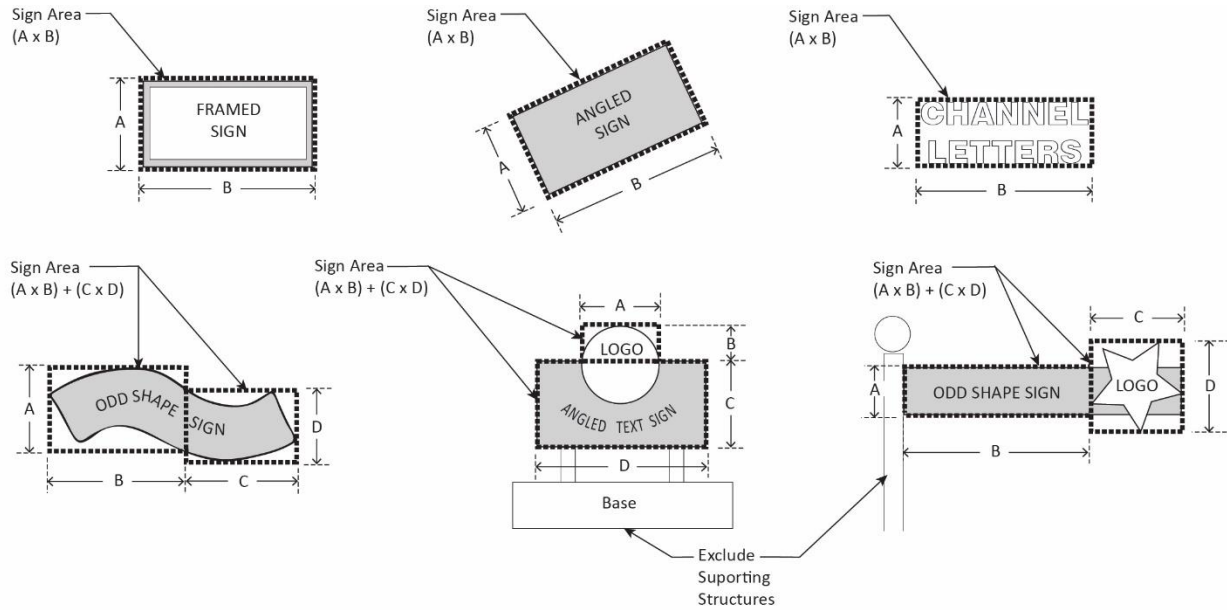

**Measuring Sign Area**

- 1. Single-Faced Signs.** The sign area of a sign with a single face area is the area of the sign face.
- 2. Double-Faced Signs.** Where two faces of a double-faced sign are located two feet or less from one another at all points, or located at an interior angle of 45 degrees or less from one another, the sign area of double-faced signs is computed as the area of one face. Where the two faces are not equal in size, the larger sign face will be used. Where two faces of a double-faced sign are located more than two feet or greater than 45 degrees from one another, both sign faces are counted toward sign area.

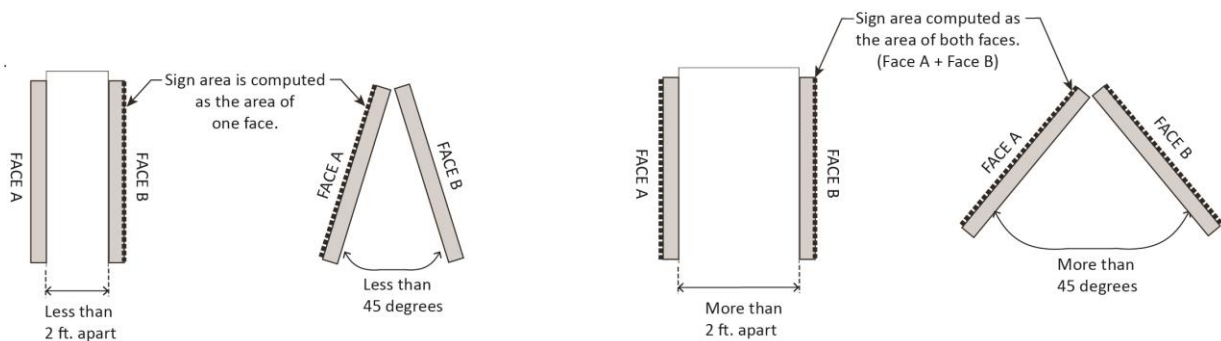

**Measuring Double-Faced Signs**

- 3. Multi-Faced Signs.** On a three-faced sign, where at least one interior angle is 45 degrees or less, the area of two faces (the largest and smallest face) must be summed

to determine sign area. In all other situations involving a sign with three or more sides, sign area will be calculated as the sum of all faces.

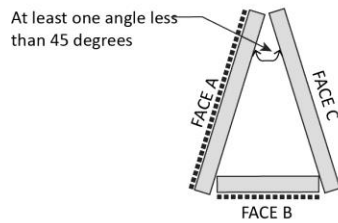

At least one angle less than 45 degrees  
 Sign area is computed as the sum of the area of the largest and smallest face.  
 (Face A + Face B)

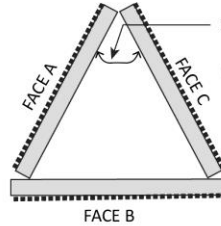

Signs with three or more sides and all angles greater than 45 degrees  
 Sign area is computed as the sum of the area of the all faces.  
 (Face A + Face B + Face C)

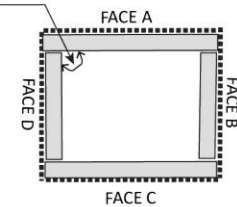

Sign area is computed as the sum of the area of the all faces.  
 (Face A + Face B + Face C + Face D)

### Measuring Multi-faced Signs

**4. Three-Dimensional (3D) Signs.** Signs that consist of, or have attached to them, one or more three-dimensional objects (i.e., balls, cubes, clusters of objects, sculpture, or statue-like trademarks), may have a sign area that is the sum of all areas using the four vertical sides of the smallest rectangular prism that will encompass the sign.

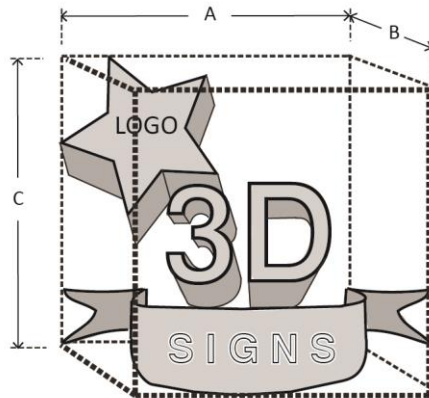

Sign area is computed using the smallest rectangular prism that will encompass the entire sign.  
 $(2(A \times C) + 2(B \times C))$

### Measuring 3D Signs

**B. Measuring Sign Height.** The height of a sign is the vertical distance from the uppermost point used to measure sign area to the existing grade immediately below the sign.

**C. Measuring Sign Clearance.** Sign clearance shall be measured as the smallest vertical distance between finished grade and the lowest point of the sign, including any framework or background embellishments.

**D. Street Frontage.** The length of street frontage is measured along the property line adjacent to the public right-of-way.

**E. Building Frontage.** Building frontage shall be measured as the widest lineal dimension, parallel to the ground, of a continuous frontage. A building's frontage is considered continuous if projections or recesses in a building wall do not exceed 10 feet in any direction.

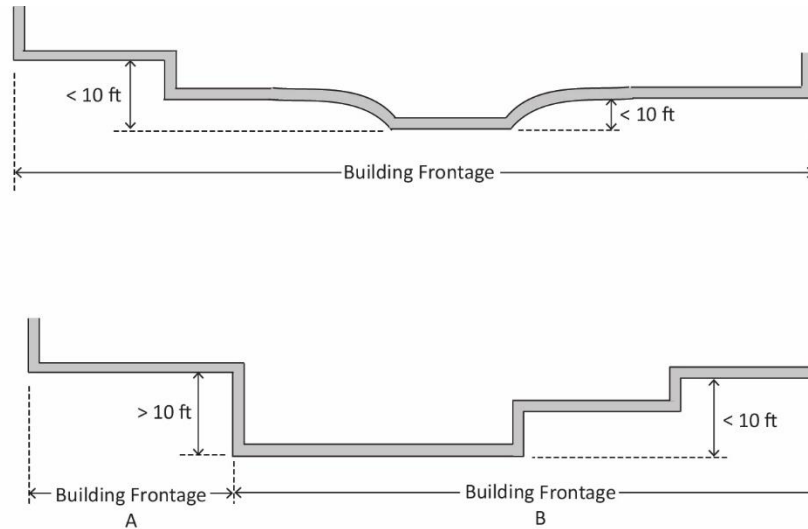

**Building Frontage**

**Section 35-138.6 General Provisions.**

This Section establishes general standards that apply to all sign types and in all zone districts.

**A. Applicable Codes.** In addition to complying with the provisions of this Section, all signs must be constructed in accordance with applicable construction, sign, and building codes and all other applicable laws, rules, regulations, and policies.

**B. Materials.** Signs shall be made of sturdy, durable materials. Paper, cardboard and other materials subject to rapid deterioration shall be limited to temporary signs. Signs made of fabric are limited to awnings, canopies, flags, and temporary signs.

**C. Minimum Sign Clearance.** Signs shall have a minimum of eight feet clearance when located above any walkway or other area people may walk.

**D. Illumination.** Where allowed, all sign illumination shall be consistent with Section 35-139 (Exterior Lighting).

**E. Changeable Copy.**

**1. Manual Changeable Copy.** Manually changeable copy is allowed.

**2. Automatic Changeable Copy and Electronic Message Center Signs.** Electronic Message Center (EMC) signs and automatic changeable copy in which copy can be

changed or altered by electric, electro-mechanical, electronic, or any other artificial energy means, are allowed subject to the following standards.

- a. **Limitations.** Electronic Message Center (EMC) signs and automatic changeable copy are limited to institutional signs and as fuel price signs at service stations.
- b. **Display Duration.** The display shall change no more frequently than once every eight seconds and must have an unlighted interval between copy displays of 0.3 second or more.
- c. **Static Message.** Displays shall contain static messages only, and shall not have movement, or the appearance or optical illusion of movement, of any part of the sign structure, design, or pictorial segment of the sign, including the movement or appearance of movement of any illumination, or the flashing, scintillating or varying of light intensity.
- d. **Light Intensity.** EMC signs shall have a maximum light intensity 0.3 foot-candles over ambient lighting conditions when measured at a distance equal to the square root of 100 times the area of the sign in square feet. All electronic copy must be equipped with a sensor or other device that automatically determines the ambient illumination and is programmed to automatically dim according to ambient light conditions, or that can be adjusted to comply with the 0.3 foot-candle measurements.
- e. **Automatic Controls.** All electronic message displays shall be equipped with automatic controls to allow for adjustment of brightness based on ambient lighting conditions.

**Section 35-138.7 Signage Allowances and Standards.**

A. **Signage Allowances and Standards.** Table 35-138.7 (Signage Allowances and Standards) establishes signage allowances for specific uses and development and standards applicable to specific sign types.

<b><u>Table 35-138.7: Signage Allowances and Standards</u></b>							
<u>Sign Type</u>	<u>Type of Development</u>	<u>Maximum Sign Area</u>	<u>Maximum Number of Signs</u>	<u>Maximum Sign Height</u>	<u>Maximum Projection</u>	<u>Location</u>	<u>Illumination</u>
<u>Awning and Canopy Signs</u>	<u>Nonresidential</u>	<u>10 square feet per sign</u>	<u>One per awning or canopy</u>	<u>18 feet</u>	<u>Shall not project further than the edge of the awning or canopy</u>	<u>Shall be attached to or painted or printed on an awning, canopy, or similar building feature</u>	<u>Not allowed</u>

**Table 35-138.7: Signage Allowances and Standards**

<u>Sign Type</u>	<u>Type of Development</u>	<u>Maximum Sign Area</u>	<u>Maximum Number of Signs</u>	<u>Maximum Sign Height</u>	<u>Maximum Projection</u>	<u>Location</u>	<u>Illumination</u>
<u>Freestanding Signs</u>	<u>Residential Development with 4 or more units</u>	<u>Total freestanding sign area of 20 square feet per entrance to the development</u>	<u>Two per entrance to the development</u>	<u>10 feet</u>	<u>Shall not project into a required setback area or public right-of-way</u>	<u>Shall be located outside required setback areas or a minimum of 5 feet from the property line, whichever is greater</u>	<u>May be illuminated</u>
	<u>Nonresidential</u>	<u>Commercial and Industrial Zones: 100 square feet per sign Other Zones: 25 square feet per sign</u>	<u>Agricultural Zones: Two per site Other Zones: One plus one per 125 feet of street frontage over 125</u>	<u>Commercial and Industrial Zones: 30 feet Other Zones: 10 feet</u>			
<u>Portable Signs (including A-board signs)</u>	<u>Nonresidential</u>	<u>6 square feet per sign</u>	<u>One per tenant space with building frontage</u>	<u>3 feet</u>	<u>Not applicable</u>	<u>May be located within setback areas. Shall not encroach upon parking spaces, driveways, pedestrian walkways, or required landscaped areas</u>	<u>Not allowed</u>
<u>Projecting and Shingle Signs</u>	<u>Nonresidential</u>	<u>6 square feet per sign</u>	<u>One per tenant space with building frontage</u>	<u>15 feet</u>	<u>Projecting Sign: Three feet from the structure facade Shingle Sign: Shall not project further than the outer edge of the feature from which it is suspended</u>	<u>-</u>	<u>Not allowed</u>

**Table 35-138.7: Signage Allowances and Standards**

<u>Sign Type</u>	<u>Type of Development</u>	<u>Maximum Sign Area</u>	<u>Maximum Number of Signs</u>	<u>Maximum Sign Height</u>	<u>Maximum Projection</u>	<u>Location</u>	<u>Illumination</u>
<u>Wall Signs</u>	<u>Residential Development with 4 or more units</u>	<u>Total wall sign area of 2 square feet per unit, maximum 20 square feet per sign</u>	<u>One per building frontage</u>	<u>Shall not extend higher than the building wall upon which they are attached</u>	<u>Maximum 6 inches from the building wall</u>	<u>Shall not cover or interrupt major architectural features such as doors, windows, or columns</u>	<u>May be illuminated</u>
	<u>Nonresidential</u>	<u>Total wall sign area of 1/8 the area of the wall upon which the sign is placed or attached</u>	<u>No limit, provided the total wall sign area per wall is not exceeded</u>				
<u>Window Signs</u>	<u>Nonresidential</u>	<u>25 percent of the window area</u>	<u>No limit, provided the maximum sign area per window is not exceeded</u>	<u>Shall not be placed on windows higher than the second story</u>	<u>Shall be flush with the window</u>	<u>-</u>	<u>Not allowed</u>
<u>Menu Boards</u>	<u>Drive-Through Facilities</u>	<u>Total menu board sign area of 36 square feet</u>	<u>Two per site</u>	<u>Freestanding menu boards: 8 feet</u> <u>Wall mounted menu boards: Shall not extend higher than the building wall upon which they are attached</u>	<u>Not applicable</u>	<u>Shall be located adjacent to a vehicle queuing lane for the service point of the drive-through facility</u>	<u>May be illuminated</u>

**BA. Special Sign Standards for Summerland.**

- 1. Applicability.** Signs within the Commercial, Industrial, and Public Utility zones located within the Summerland Community Plan area shall comply with the regulations of the other Sections of this Chapter, as well as the regulations of this Section. If there is a conflict, the regulations of this Section shall apply.



**2. Allowed signs.** Only those signs of each type listed below shall be allowed to be erected or maintained on any structure, or lot located in the Commercial, Industrial, and Public Utility Zones.

**a. Wall signs.** One or more wall signs on each ~~street~~ building frontage unlighted or indirectly lighted. These signs shall not exceed the lesser of the following areas:

- 1) One-tenth of the square footage of the structure façade of that portion of a single floor occupied by a business and upon which façade the wall sign is to be located;  
or
- 2) 60 square feet.

If more than one business occupies the same structure, the businesses may have separate signs or they may share the sign space, so long as the combined sign area does not exceed the allowed sign area.

**b. Identification signs.** One identification sign, unlighted or indirectly lighted, not to exceed 10 square feet in area, and not more than five feet in height measured from the ground to the top of the sign, that identifies the business primarily being conducted on the premises.

**c. Banner signs.** One banner sign, unlighted, not to exceed 16 square feet on the façade having street frontage of the structure occupied by the business. The banner sign may not be displayed for more than a rolling 30-days within a three month period.

**3. Sign standards.**

**a. Construction.** The exposed face of signs shall be either of wood (painted and/or carved) or of painted non-gloss material. Signs of other material shall be deemed to be banner signs.

**b. Illumination.** Illuminated signs shall be externally lit and the lighting source shall be shielded or situated so as not to cast stray light beyond the property line on which they are installed. The source of illumination shall be extinguishable at closing time of the business.

**c. Neon signs.** Neon signs that comply with the following criteria may be approved by the Board of Architectural Review in compliance with Section 35-184 (Board of Architectural Review):

- 1) The sign is not within 100 feet of residentially zoned areas.
- 2) The sign does not face directly towards or is visible from residentially zoned areas.
- 3) The sign is compatible with other uses on the property and in the immediate vicinity.
- 4) The sign is appropriate for the type of structure.

- 5) The sign is appropriate for the type of business.
  - 6) The sign is artistic and subtle in the design and execution.
  - 7) The sign is secondary in size and purpose to the primary signage of the business.
- 4. Prohibited signs.** It shall be unlawful to erect or maintain:
- a. **Internally illuminated signs.** (e.g., fluorescent tube behind plastic panel).
  - b. **Pole signs.** Freestanding pole signs higher than five feet measured from the ground at the base of the supporting structure to the top of the sign.

### **Section 35-138.8 Procedures.**

**A. Sign Certificate of Conformance Required.** Except for signs exempt from permit requirements in compliance with Section 35-138.3 and signs requiring the approval of a Coastal Development Permit in compliance with Section 35-138.8.B, a Sign Certificate of Conformance in compliance with Section 35-179G (Sign Certificate of Conformance) shall be required for all signs.

**B. Coastal Development Permit Required.** A Coastal Development Permit in compliance with Section 35-169 (Coastal Development Permit) shall be required for the following:

1. Signs located within a designated environmentally sensitive habitat area.
2. Permanent signs located on or within a beach, tideland, shoreline, or waterway.
3. Signs that could impact public access to or along tidelands, shorelines, beaches and public waterways, public trails, public parks, public open space.

**C. Modification to Sign Standards.** Modifications to the standards established in Section 35-138 (Signs and Advertising Structures) are allowed in compliance with Section 35-179F (Overall Sign Plans).

**D. Overall Sign Plan.** An Overall Sign Plan in compliance with Section 35-179F (Overall Sign Plan) shall be required for the following:

1. Developments with four or more nonresidential tenants that will have individual signs.

### **Section 35-138.9 Nonconforming Signs.**

**A. Continuance and Maintenance.** The use of a nonconforming sign may be continued, maintained, altered, reconstructed, and restored pursuant to Division 10 (Nonconforming Structures and Uses).

**B. Removal.** Whenever a nonconforming sign has been abandoned, or the use of the property has been discontinued for a continuous period of at least 12 consecutive months, the nonconforming sign must be removed.

**Section 35-138.10 Maintenance.**

Each sign displayed within the County, including exempt signs, shall be maintained to comply with the following standards:

- A. Graffiti on a sign shall be removed within seven days of notice of its placement on the sign.
- B. The display upon any sign area of a sign shall be maintained in good condition, without rips, tears, and/or similar damage.
- C. All parts, portions, units and materials composing a sign, together with the frame, background, surface, support or enclosure shall be maintained in a safe condition, painted, and adequately protected from weathering with all braces, bolts and structural parts and supporting frames and fastenings reasonably free from deterioration, rot, rust, and loosening so that they do not create a hazard to persons or property or constitute a nuisance.
- D. Any sign or sign structure that is sagging, leaning, fallen, decayed, broken, deteriorated, or in a dilapidated condition shall be promptly repaired, to the satisfaction of the County, or removed.
- E. Whenever any sign, by virtue of its physical nature and condition, poses an immediate and serious threat to the public safety, the sign may be removed by County personnel, or its physical deficiency cured, to the extent necessary to protect the public safety. The cost of such removal or repair shall be assessed against the sign or property owner.
- F. An on-premise sign identifying an activity, business, service or product shall be removed within 30 days following the discontinuance of the activity, business, service or product. If the sign is not so removed, the Director may have the sign removed in accordance with the public nuisance abatement provisions of this Code.

**Section 35-138.11 Violation and Enforcement of Sign Regulations.**

**A. Violations.** A sign set up, applied, erected, constructed, altered, affixed, repaired, installed, relocated, enlarged, converted, maintained, or projected as an image contrary to the provisions of Section 35-138 (Signs and Advertising Structures), shall be and is declared to be unlawful and a public nuisance and shall be subject to the provisions of Section 35-185 (Enforcement, Legal Procedures, and Penalties).

**B. Enforcement.** Enforcement of the provisions of Section 35-138 (Signs and Advertising Structures) shall be in compliance with Section 35-185 (Enforcement, Legal Procedures, and Penalties).

**SECTION 10:**

DIVISION 7, General Regulations, of Article II, the Coastal Zoning Ordinance, of Chapter 35, Zoning, of the Santa Barbara County Code, Section 35-139, Exterior Lighting, is amended to read as follows:

**Section 35-139. – Exterior Lighting.**

- A. Purpose.** The purpose of this Section is to create standards for outdoor lighting that minimize light pollution caused by inappropriate or misaligned light fixtures. These standards conserve energy and preserve the nighttime sky while maintaining night-time safety, utility, security and productivity. The County recognizes that the unique development patterns and environments of the County make them ideal areas for astronomical observation and enjoyment of the nighttime sky. Additionally, resources in the County warrant the protection of nighttime viewsheds and wildlife corridors from light trespass. The County, through the provisions contained herein, intends to preserve and protect the nighttime environment of the County by regulating unnecessary and excessive outdoor lighting. See “Lighting” within Section 35-58 (Definitions) for definitions related to outdoor lighting used within this Section.
- B. Applicability.** The standards of this Section apply to all new or replaced outdoor light fixtures or systems and to existing lighting as provided below unless specifically exempted or required pursuant to any other applicable code or regulation.
- 1. Existing Lighting.** All outdoor lighting fixtures lawfully installed prior to the effective date of this Section are subject to only Subsections E.4 (Glare Prevention) and E.7 (Timing Controls) of this Section.
  - 2. New and Replaced Lighting.** The standards of this Section apply to all new or replaced outdoor light fixtures or systems, except as specifically exempted pursuant to Subsection B.4 (Exemptions) below.
  - 3. Additions and Remodels.** Additions totaling 50 percent or more of the existing gross floor area of a structure or exterior alterations affecting 50 percent or more of a building’s exterior shall require that all existing lighting on the lot be brought into compliance with the provisions of this Section.
  - 4. Exemptions.** The following types of lighting are exempt from the provisions of this Section.
    - a. Fossil fuel lights.**
    - b. Traffic control signs and devices.**
    - c. Street lights installed prior to the effective date of the Ordinance adding this Section.**
    - d. Temporary construction or emergency lighting under direction of a public agency (e.g., fire, police, public works).**

- e. Navigation lights (e.g., airports, heliports, radio/television towers).
- f. Seasonal lighting decorations in place no longer than 60 days per calendar year.
- g. Light fixtures with a maximum output of 60 lumens, including solar lights.
- h. Underwater lights used to illuminate swimming pools, spas, fountains, and other water features.
- i. Temporary lighting for agricultural activities of a limited duration, not including unshielded arena lights.

**5. Alternative Compliance.** The provisions of this Section are not intended to prevent the use of any design, material or method of installation not specifically prescribed by this Section provided any such alternate has been approved by the Director as part of a planning permit. The Director may approve any such alternate provided that the proposed design, material or method:

- a. Provides approximate equivalence to the specific requirements of this Section; and
- b. Is otherwise satisfactory and complies with the purpose of this Section.

**C. Prohibited Lights and Lighting.** The following lights and lighting are prohibited:

- 1. Search lights, strobe lights, laser source lights, or similar high intensity lights except as specifically exempted or for the purposes of gathering meteorological data.
- 2. Mercury vapor lights.
- 3. Uplighting.

**D. Maximum Light Levels.** Outdoor lighting shall comply with the following maximum light levels except where otherwise allowed through the approval of the Conditional Use Permit or Development Plan, as applicable.

**1. Light Levels Within Designated Environmentally Sensitive Habitat Areas and Buffer Areas.**

- a. Environmentally Sensitive Habitat Areas shall not be illuminated, including illumination of the Environmentally Sensitive Habitat area from a light source located outside of the Environmentally Sensitive Habitat area.
- b. The maximum lighting level within designated Environmentally Sensitive Habitat areas shall not exceed 0.0 foot-candles.
- c. No light fixture located within an Environmentally Sensitive Habitat buffer area shall exceed 630 lumens.

**2. Light Levels at Property Lines.** The light level at property lines shall not exceed 0.1 foot-candles, except as provided below.

**a. Multi-family Zoned Property Abutting or Within a Multi-family, Commercial, or Industrial Zone.** Where a property is located within a Multi-family Zone and the neighboring property is located within a Multi-family, Commercial, or Industrial Zone, the maximum lighting level at the shared property line shall be 0.2 foot-candles.

**b. Commercial and Industrial Zoned Property.**

**(1) Abutting a Multi-family Zone.** Where a property is located within a Commercial or Industrial Zone and the neighboring property is located within a Multi-family Zone, the maximum lighting level at the shared property line shall be 0.2 foot-candles.

**(2) Abutting or Within a Commercial or Industrial Zone.** Where a property is located within a Commercial or Industrial Zone and the neighboring property is located within a Commercial or Industrial Zone, the maximum lighting level at the shared property line shall be 0.25 foot-candles.

**E. General requirements.**

**1. Shielding.** All outdoor light fixtures shall be fully shielded or full cut off, except as provided below.

**a.** Decorative string lights are not required to be shielded.

**b.** Outdoor light fixtures used for outdoor recreational facilities shall be fully shielded except when such shielding would cause impairment to the visibility required in the intended recreational activity. In such cases, partially shielded fixtures and downward lighting methods shall be utilized to limit light pollution, glare, and light trespass to a reasonable level as determined by the Director.

**c.** Partially shielded light fixtures may be allowed provided the light source is obscured by translucent glass or other means, the light fixture does not exceed 850 lumens, and the lighting complies with all other provisions of this Section.

**2. Externally Illuminated Signs, Advertising Displays and Building Identification.** Externally illuminated signs, advertising displays and building identification shall use top mounted light fixtures which shine downward.

**3. Maximum Height.** Lighting fixtures shall be installed at the lowest height required to achieve the design purpose of the lighting fixture.

**a. Building Mounted.** Light fixtures shall not exceed the height of the building upon which it is attached.

**b. Freestanding Light Fixtures.** The maximum height of freestanding light fixtures and lighting fixtures mounted on a structure or feature other than a building is as follows:

**(1)** Within 100 feet of a Residential Zone: 15 feet from finished grade.

(2) Other Locations: 20 feet from finished grade.

c. **Exceptions.** The Director may allow additional height for activities, uses, or development with unique lighting needs; for accentuating historic architectural features of a building, accentuating signage and/or landscape features; lighting of recreational facilities; or for security purposes.

4. **Glare Prevention.** All lights shall be directed and oriented to prevent light spillover and glare onto adjacent properties. No unobstructed beam of exterior light shall land off-site.

5. **Traffic Safety.** Lighting shall be designed so as not to interfere with vehicular traffic on any portion of a street.

6. **Kelvin.** Light fixtures for outdoor security lighting shall not exceed 4,000 Kelvin. All other outdoor light fixtures shall not exceed 3,000 Kelvin.

7. **Timing Controls.** Outdoor lighting shall be turned off during daylight hours and between 9:00 p.m. and sunrise the following day, except as provided below.

a. **When People are Present.** Outdoor lighting may remain on when people are present in the outdoor areas being illuminated, except as provided below.

(1) In Residential Zones and any area adjacent to a Residential Zone, outdoor lighting shall be turned off as follows:

(a) Sunday through Thursday: between 10:00 p.m. and sunrise the following day.

(b) Friday and Saturday: between midnight and sunrise the following day.

b. **Code Required Lighting.** Building or other construction and safety code required lighting for steps, stairs, walkways, entrances, parking areas, and other building and site features that is dimmed to the minimum light level necessary to meet code requirements.

c. **Safety and Security Lighting.**

(1) **Motion-Controlled Security Lighting.** Security lighting may be controlled by a motion-sensor switch between the hours of 9:00 p.m. and sunrise the following day provided the lighting does not remain on longer than five minutes after activation.

(2) **Commercial and Industrial Zones Not Adjacent to Residential Zones.** Outdoor security lighting in Commercial and Industrial Zones not adjacent to a Residential Zone may remain on between 9:00 p.m. and sunrise the following day provided they are dimmed to the minimum level to meet safety and security requirements and are on a timer or sensor that automatically extinguishes the light when sufficient daylight is available.

**(3) Additional Security Lighting.** Additional security lighting may be allowed through the approval of the Conditional Use Permit or Development Plan, as applicable.

**d. On-Premise Signs.** All illuminated advertising signs shall not be illuminated between 11:00 p.m. and sunrise the following day, except that on-premises signs may be illuminated while the business is open to the public.

**e. Private Recreational Courts.** Private lighting of recreational sports courts shall be prohibited between the hours of 9:00 p.m. and sunrise the following day.

**F. Submittal of plans and evidence of compliance.** Any application for a permit that includes outdoor light fixtures subject to the standards of this Section shall include evidence that the proposed outdoor lighting will comply with all of the standards of this Section. The application shall include:

1. Plans showing the locations of all outdoor lighting fixtures.

2. Description of the outdoor lighting fixtures including manufacturers catalog cuts and drawings. Descriptions and drawings shall include lamp or bulb type, wattage, lumen output, beam angle, and shielding.

3. Photometric plans showing foot-candle readings every ten feet within the property or site and ten feet beyond the property lines, except as provided below.

a. Applications for outdoor lighting associated with residential development of four or fewer units and property-owner installed lighting are not required to submit photometric plans unless requested by the Director due to project location, size, use, and proposed lighting.

4. The above plans and descriptions shall be sufficiently complete to enable the plan examiner to readily determine whether compliance with the requirements of this Section have been met.

**G. Temporary exemption.** The following temporary exemptions may be allowed in accordance with the provisions of Section 35-137 (Temporary Uses).

1. The Director may grant a temporary exemption from one or more requirements of this Section for such activities, including, but not limited to circuses, fairs, carnivals, sporting events, and promotional activities, only if all of the following findings are first made:

a. The purpose for which the lighting is proposed is not intended to extend beyond 30 days.

b. The proposed lighting is designed in such a manner as to minimize light pollution as much as feasible.

c. The proposed lighting will comply with the general purpose of this Section.



2. The application for a temporary exemption shall at a minimum include all of the following information:

- a. Name and address of applicant and property owner.
- b. Location of proposed fixtures.
- c. Type, wattage and lumen output of lamp(s).
- d. Type and shielding of proposed fixtures.
- e. Intended use of lighting.
- f. Duration of time for requested exemption.
- g. The nature of the exemption.

3. Such other information as the Department may request.

~~All exterior lighting shall be hooded and no unobstructed beam of exterior lighting shall be directed toward any area zoned or developed residential, or toward any environmentally sensitive habitat area. No lighting shall be so designed as to interfere with vehicular traffic at any portion of a street. Division 13 (Summerland Community Plan Overlay), Division 14 (Goleta Community Plan and Eastern Goleta Valley Community Plan Overlay Districts), Division 16 (Montecito Community Plan Overlay District), and Division 17 (Gaviota Coast Plan Overlay) include additional requirements.~~

**SECTION 11:**

Section 35-179F, Overall Sign Plans, is hereby added to DIVISION 11, Permit Procedures, of Article II, the Coastal Zoning Ordinance, of Chapter 35, Zoning, of the Santa Barbara County Code, to read as follows:

**35-179F. – Overall Sign Plans.**

**A. Purpose and intent.** This Section establishes procedures and findings for the approval of Overall Sign Plans to provide a method for an applicant to integrate the design and placement of signs within a project with the overall development design to achieve a more unified appearance and to ensure that signs within a multi-nonresidential tenant development are visually attractive and are in a harmonious relationship to one another.

**B. Applicability.**

**1. Mandatory Overall Sign Plans.** An Overall Sign Plan is required for all proposed signs associated with developments with four or more nonresidential tenant spaces that will have individual signs.

**2. Optional Overall Sign Plans.** Overall Sign Plans are optional for signs associated with any other type of project.

**C. Allowed modifications.** The review authority may allow the following sign modifications as part of the approval of an Overall Sign Plan:

- 1. Freestanding signs.** An increase in the height, number and size limitations on freestanding signs.
- 2. Menu boards for drive-through restaurants.** An increase in the area limitation of menu boards.
- 3. Awning and canopy signs.** An increase in the area limitation of awning and canopy signs.
- 4. Projecting and shingle signs.** An increase in the area limitation of projecting and shingle signs.
- 5. Wall sign.** An increase in the area limitation of wall signs.

**D. Contents of application.** As many copies of an Overall Sign Plan application as may be required shall be submitted to the Planning and Development Department. Said application shall contain full and complete information as required pertaining to the request.

**E. Processing.**

- 1. An application for an Overall Sign Plan shall be submitted concurrently with an application for a Development Plan for a development with four or more nonresidential tenant spaces that will have individual signs and shall be processed in conjunction with such Development Plan application, except as provided below.**
  - a. An application for an Overall Sign Plan may be submitted independently if the Overall Sign Plan is for an existing development and the processing of a new or revised Development Plan is not required.**
- 2. Review authority.**
  - a. The review authority for an Overall Sign Plan submitted concurrently with an application for a Development Plan shall be the review authority for the Development Plan.**
  - b. The review authority for an application for an Overall Sign Plan submitted independent of a Development Plan in compliance with Subsection 1.a, above, and for projects that are not subject to Development Plan approval, shall be the Director.**
- 3. After receipt of an application for an Overall Sign Plan, the Department shall review the application in compliance with the requirements of the California Environmental Quality Act.**
- 4. The Overall Sign Plan shall be subject to Design Review in compliance with Section 35-184 (Board of Architectural Review).**
- 5. Notice of filing of an application and notice of review authority action shall be given in compliance with Section 35-181 (Noticing).**

a. In addition to mailed notice required in compliance with Section 35-181 (Noticing) notice shall also be mailed a minimum of 10 days prior to the review authority action to all tenants within the development.

6. The action of the review authority is final subject to appeal in compliance with Section 35-182 (Appeals).

**F. Findings required for approval.** An Overall Sign Plan application shall be approved or conditionally approved only if the review authority first makes all of the following findings:

**1. Findings for all Overall Sign Plans.**

a. The proposed project will be compatible with the neighborhood, and will not create an adverse impact to aesthetics, community character, or public views.

b. The proposed project will comply with all applicable requirements of this Development Code and the Comprehensive Plan, including any applicable community or area plan.

**2. Additional findings required for Overall Sign Plans that include modifications.** If an Overall Sign Plan includes any modifications in compliance with Subsection C (Allowed modifications) above, then the Overall Sign Plan application shall be approved or conditionally approved only if the review authority first makes all of the following findings, as applicable:

**a. Freestanding signs.** The proposed area, height, or number of freestanding signs is architecturally harmonious in relation to the size and location of the development.

**b. Menu boards for drive-through restaurants.**

(1) The proposed area of the menu board is architecturally harmonious in relation to the size and location of the structure on which it will be placed.

(2) The proposed area of the menu board is architecturally harmonious in relation to the size and location of the area in which the structure is constructed.

**c. Awning and canopy signs.** The proposed area of the awning or canopy sign is architecturally harmonious in relation to the size and location of the building area occupied by the enterprise proposing the sign.

**d. Projecting and shingle signs.** The proposed area of the projecting or shingle sign is architecturally harmonious in relation to the size and location of the building area occupied by the enterprise proposing the sign.

**e. Wall signs.**

(1) The proposed area of the wall sign is architecturally harmonious in relation to the size and location of the structure on which it will be placed.

(2) The proposed area of the wall sign is architecturally harmonious in relation to the

size and location of the area on which the structure is constructed.

## **SECTION 12:**

Section 35-179G, Sign Certificate of Conformance, is hereby added to DIVISION 11, Permit Procedures, of Article II, the Coastal Zoning Ordinance, of Chapter 35, Zoning, of the Santa Barbara County Code, to read as follows:

### **35-179G. – Sign Certificate of Conformance.**

- A. Purpose and intent.** This Section establishes procedures and findings for the approval of Sign Certificates of Conformance that are required in compliance with Section 35-138 (Signs and Advertising Structures). The intent of this Section is to ensure that proposed signage is visually attractive and complies with the goals of the County.
- B. Applicability.** Before erecting, applying, installing, affixing, altering, relocating or projecting as an image any signage, a Sign Certificate of Conformance shall be issued, unless identified as exempt from permit requirements by Section 35-138 (Signs and Advertising Structures).
- C. Contents of application.** As many copies of a Sign Certificate of Conformance application as may be required shall be submitted to the Planning and Development Department. Said application shall contain full and complete information as required pertaining to the request.
- D. Processing.**
- 1. Review for compliance.** The Director shall review the Sign Certificate of Conformance application for compliance with the Comprehensive Plan including applicable community or area plans, this Coastal Zoning Ordinance, applicable Overall Sign Plan, and other applicable conditions and regulations, and approve, conditionally approve or deny the request. A Sign Certificate of Conformance shall not be issued by the Director until all necessary prior approvals have first been obtained.
  - 2. Decision not subject to appeal.** The action of the Director to issue, conditionally issue or deny a Sign Certificate of Conformance is final and not subject to appeal.
- E. Certificate expiration.** A Sign Certificate of Conformance shall remain valid only as long as compliance with all applicable requirements of this Coastal Zoning Ordinance and the issued certificate continues.

## **SECTION 13:**

DIVISION 12, Administration, of Article II, the Coastal Zoning Ordinance, of Chapter 35, Zoning, of the Santa Barbara County Code, Subsection 3, Gaviota Coast, Summerland, and Toro Canyon, of Section 35-184.2, Applicability, of Section 35-184, Board of Architectural Review, is amended to read as follows:

- 3. Gaviota Coast, Summerland and Toro Canyon.** In addition to the items identified in Section 35-184.2.2, for sites located within the Gaviota Coast Plan, Summerland Community Plan or the Toro Canyon Area Plan areas, the provisions of this Section shall also apply to any structure, additions to a structure, or sign, except as provided below.
- a. The structure, addition to a structure, or sign is exempt from Board of Architectural Review in compliance with Section 35-184.3 (Exceptions).
  - b. Single agricultural structures located within the Gaviota Coast Plan area that have an individual gross floor area of less than 5,000 square feet are not subject to the requirements of this Subsection 3 (Gaviota Coast, Summerland and Toro Canyon) provided:
    - 1) The existing cumulative structural development located on the lot that the structure is proposed to be located on does not exceed 10,000 square feet per lot.
    - 2) The structure(s) complies with the following standards:
      - a) All exterior lighting is in compliance with the following:
        - i) The lighting is required for safety purposes only.
        - ii) ~~Exterior lighting complies with Section 35-139 (Exterior Lighting). Light fixtures are fully shielded (full cutoff and are directed downward to minimize impacts to the rural nighttime character.~~
        - iii) Lighting is directed away from habitat areas and, to the extent feasible, nearby residences, public roads and other areas of public use.
      - b) The structure uses building materials, earth tone colors, and non-reflective paints that are compatible with the surrounding natural environment to maximize the visual compatibility of the development with surrounding areas.

**SECTION 14:**

DIVISION 13, Summerland Community Plan Overlay, of Article II, the Santa Barbara County Coastal Zoning Ordinance, of Chapter 35, Zoning, of the Santa Barbara County Code, Section 35-191.9, Exterior Lighting Standards, of Section 35-191, Summerland Community Plan Overlay, is hereby deleted in its entirety and reserved for future use.

**SECTION 15:**

DIVISION 14, Goleta Community Plan and Eastern Goleta Valley Community Plan Overlay Districts, of Article II, the Coastal Zoning Ordinance, of Chapter 35, Zoning, of the Santa Barbara County Code, Section 35-192.3, Exterior Lighting Within the Eastern Goleta Valley Community Plan Area, in its entirety, of Section 35-192, General, is here by deleted in its entirety and

reserved for future use.

**SECTION 16:**

DIVISION 17, Gaviota Coast Plan (GAV) Overlay, of Article II, the Coastal Zoning Ordinance, of Chapter 35, Zoning, of the Santa Barbara County Code, Subsection B, Outdoor Lighting, of Section 35-440, Gaviota Coast Plan (GAV) Overlay, is hereby deleted in its entirety and subsequent subsections are renumbered as applicable for consistency.

**SECTION 17:**

DIVISION 17, Gaviota Coast Plan (GAV) Overlay, of Article II, the Coastal Zoning Ordinance, of Chapter 35, Zoning, of the Santa Barbara County Code, Subsection D, Signs and advertising structures, of Section 35-440, Gaviota Coast Plan (GAV) Overlay, is hereby amended to read as follows:

**CD. Signs and advertising structures.**

1. Signs and advertising structures that are accessory to a use allowed in the AG-II zone may be allowed in compliance with Section 35-138 (Signs and Advertising Structures).
2. Signs ~~shall be permitted pursuant to Section 35-138.8 (Procedures). are development that require the issuance of a Coastal Development Permit in compliance with Section 35-169 (Coastal Development Permits) except where exempt in compliance with Section 35-430.D (Exempt activities and structures).~~
  - a. ~~A sign that is incidental, appropriate and subordinate to a use designated as a Principal Permitted Use shall be also be considered a Principal Permitted Use.~~
  - b. ~~If the issuance of a Coastal Development Permit in compliance Section 35-169 (Coastal Development Permits) is required then a Sign Certificate of Conformance shall not be required in addition to the Coastal Development Permit.~~

**SECTION 18:**

All existing indices, section references and numbering, and figure and table numbers contained in the Article II, the Santa Barbara County Coastal Zoning Ordinance, of Chapter 35, Zoning, of the Santa Barbara County Code, are hereby revised and renumbered as appropriate to reflect the revisions enumerated above.

**SECTION 19:**

Except as amended by this ordinance, Article II, the Santa Barbara County Coastal Zoning Ordinance, of Chapter 35, Zoning, of the Santa Barbara County Code, shall remain unchanged and shall continue in full force and effect.

**SECTION 20:**

If any section, subsection, sentence, clause or phrase of this ordinance is for any reason held to be invalid, such decision shall not affect the validity of the remaining portions of this ordinance. The Board of Supervisors hereby declares that it would have passed this ordinance and each section, subsection, sentence, clause and phrase thereof, irrespective of the fact that any one or more sections, subsections, sentences, clauses, or phrases be declared invalid.

**SECTION 21:**

If legislation is enacted which would superseded or preempt any section or subsection of this ordinance then the Board of Supervisors deems that section or subsection null and void and this ordinance shall remain in full force and effect without said section or subsection.

**SECTION 22:**

This ordinance and any portion of it approved by the Coastal Commission shall take effect and be in force 30 days from the date of its passage or upon the date that it is certified by the Coastal Commission pursuant to Public Resources Code §30514, whichever occurs later; and before the expiration of 15 days after its passage, it, or a summary of it, shall be published once, together with the names of the members of the Board of Supervisors voting for and against the same in a newspaper of general circulation published in the County of Santa Barbara.

PASSED, APPROVED, AND ADOPTED by the Board of Supervisors of the County of Santa Barbara, State of California, this \_\_\_\_\_ day of \_\_\_\_\_, 2024, by the following vote:

AYES:

NOES:

ABSTAIN:

ABSENT:

---

STEVE LAVAGNINO, CHAIR  
BOARD OF SUPERVISORS  
COUNTY OF SANTA BARBARA

ATTEST:

Outdoor Lighting, Signs, and Miscellaneous Ordinance Amendments  
Case No. 24ORD-00003  
Montecito Planning Commission  
Hearing Date: September 18, 2024  
Attachment D-1 – Page 44

MONA MIYASATO, COUNTY EXECUTIVE OFFICER  
CLERK OF THE BOARD

By \_\_\_\_\_  
Deputy Clerk

APPROVED AS TO FORM:

RACHEL VAN MULLEM  
COUNTY COUNSEL

By \_\_\_\_\_  
Deputy County Counsel

G:\GROUP\COMP\Ordinances\Outdoor Lighting and Signs\Public Hearings\MPC\9-18 Memo\ATT D-1 CZO Amendments.docx