

RECORDING REQUESTED BY,
FOR THE BENEFIT OF, AND
WHEN RECORDED MAIL TO:

COUNTY OF SANTA BARBARA
CLERK OF THE BOARD OF SUPERVISORS
105 E. Anapamu Street
Santa Barbara, CA 93101

APN: 100-400-008

No Fee Per Gov. Code § 6103

This conveyance is exempt from the Documentary Transfer Tax pursuant to Section 11922 of the California Revenue and Taxation Code in that the title conveyed is being acquired by the County of Santa Barbara, a political subdivision of the State of California.

**IRREVOCABLE OFFER OF DEDICATION
OF
REAL PROPERTY: LOTS # 42 AND 43 OF TRACT MAP 14,812 AND GR-1 TRAIL
SEGMENT THEREIN**

Whereas, on January 11, 2017, the County Planning Commission approved the Vintage Ranch Project Development Plan (Case No. 15DVP-00000-00002), Vesting Tentative Tract Map (Case No. 15TRM-00000-00002/TM 14,812), Road Naming (Case No. 15RDN-00000-00002), and Conditional Use Permit (Case No. 15CUP-00000-00006) (“Project Approval”).

Whereas, on March 25, 2020, the County Planning Commission approved a three-year time extension for Case No. 15TRM-00000-00002 until January 24, 2023 and a one-year time extension for Case Nos. 15DVP-00000-00002 and 15CUP-00000-00006 until January 24, 2023.

Whereas, the approved Project Description for the Vintage Ranch Final Development Plan requires that 55.8% (18.46 acres) of the site remain in open space that would be dedicated to the County and that a multi-use trail, consistent with the location of trail GR-1 identified in the Orcutt Community Plan, would be developed within the open space area and would be dedicated to the County concurrent with the designated open space.

In consideration of the Project Approval and based on the terms of the Grantor’s offer as detailed in the approved Project Description, Vintage Ranch Orcutt, LLC, a California Limited Liability Company (herein referred to as “Grantor”), hereby irrevocably offers to dedicate (herein the “Irrevocable Offer of Dedication”) to the County of Santa Barbara in perpetuity, a political subdivision of the State of California (herein referred to as “County”), for the public in general, real property, lot numbers 42 and 43 of Tract Map 14,812 which is currently owned by Grantor in the County of Santa Barbara, State of California, more particularly described in Exhibit A and depicted in Exhibit B, both of which are attached hereto and incorporated herein by reference (herein the “Property”).

SEE ATTACHED EXHIBITS A & B

Prior to acceptance of this offer or within two years from recordation of the offer, whichever occurs first, Grantor shall construct the proposed trail. Grantor shall maintain the open space area for two years from the date of construction of the trail, excepting areas within the open space that are subject to restoration or mitigation requirements. Consistent with the approved Open Space Management Plan dated June 2016, restored areas will be the responsibility of Vintage Ranch Orcutt, LLC, followed by the HOA, for five years or until all restoration and mitigation requirements are met. When all restoration efforts are complete and plantings are self-sufficient, management of restoration areas within the open space will pass to the County. The party responsible for the long-term management of the open space and its restored areas will be the County; the County will not accept responsibility for maintenance or monitoring activities associated with mitigation requirements, and only completed restoration areas will be accepted under County management. Fuel management in the designated zones described in the Open Space Management Plan will remain the responsibility of the HOA in perpetuity.

Grantor shall manage and maintain in perpetuity any fencing, drainage improvements, landscaping, retaining walls, vegetative buffers, fuel modification (e.g., brush clearing) and any other improvements within the dedicated County open space that will serve the development.

With the exception of the CON/SPAN (precast) bridge system, Black Oak Drive improvements, culvert, headwalls, limited storm drain facilities with associated infiltration areas, and underground utilities, Lot #42 and #43 shall remain in natural, undeveloped open space per the project plans. No development except that approved on January 11, 2017 by the County Planning Commission shall be permitted within this area. Public Trails, signage, extensive landscaping and irrigation shall be provided as specified in the project conditions of approval.

Grantor shall develop the trail system including fencing and signage to standards and specifications of the Orcutt Community Plan (Orcutt Multiple Use Trails Plan and Trail Siting and Design Guidelines) and County of Santa Barbara Community Services Department Parks Division. Grantor shall be responsible for the construction and maintenance of the trail system for two years.

After the Grantor's aforementioned two-year maintenance period expires, the Orcutt Community Facilities District will be the funding source for all trails within the dedicated real property open space areas.

This Irrevocable Offer of Dedication is made pursuant to Section 7050 of the Government Code of the State of California and may be accepted at any time by the Board of Supervisors of the County of Santa Barbara. The Board of Supervisors acknowledge this Irrevocable Offer of Dedication on April 6, 2021.

Upon recordation, this Irrevocable Offer of Dedication shall have the effect of a granting dedicated open space access in gross and perpetuity that shall run with the land in favor of the County and be binding on the Grantor and their heirs, personal representative, assigns, or successors in interest.

This Irrevocable Offer of Dedication shall convey to the County of Santa Barbara upon its acceptance, open space over Lots #42 and #43 and the trails, both in fee. The above-referenced real property dedication shall be kept open, clear, and free from buildings or structures of any kind not shown on the Project Approval.

The term, GRANTOR, as used herein shall include the plural as well as the singular number and the word "he" shall include the feminine and neuter gender as the case may be.

Remedies. Grantor and County may pursue any and all available legal and/or equitable remedies to enforce the terms and conditions of this Offer. A failure by Grantor or the County in one or more instances to enforce the terms of this Offer shall not be deemed a waiver of any future right to pursue such remedies with respect to a subsequent breach of the same or any other provision of this Offer.

Taxes and Assessments. Grantor agrees to pay or cause to be paid all real property taxes and assessments levied or assessed against the Parcels. This Offer and its use restrictions shall constitute enforceable restrictions within the meaning of (i) Article XIII, Section 8, of the California Constitution and (ii) Section 402.1 of the California Revenue and Taxation Code or successor statute. Furthermore, this Offer shall constitute a servitude upon and burden to the Parcels within the meaning of Section 3712(d) of the California Revenue and Taxation Code, or successor statute, which survives a sale of tax-deeded property.

Condition of Title. This offer shall be recorded free of prior liens and encumbrances (other than existing and approved easements for roads, trails, and utilities) which the County determines may affect the interest being conveyed.

Severability. If any provision of this Offer is held to be invalid, or for any reason becomes unenforceable, the remaining provisions of the Offer shall remain valid and enforceable.

[SIGNATURES ON FOLLOWING PAGES]

By: VINTAGE RANCH ORCUTT, LLC,
a California limited liability company

By: [Signature] Date: 3/11/2021
Gary Grossman, Manager
Vintage Ranch Orcutt, LLC
a California limited liability company, its Managing Member

ACKNOWLEDGMENT

A notary public or other officer completing this certificate verifies only the identity of the individual who signed the document to which this certificate is attached, and not the truthfulness, accuracy, or validity of that document.

State of California
County of San Luis Obispo

On 3-11-2021 before me, David Thomas Cool Notary Public,
(insert name and title of the officer)

personally appeared Gary Grossman,
who proved to me on the basis of satisfactory evidence to be the person(s) whose name(s) is/are
subscribed to the within instrument and acknowledged to me that he/she/they executed the same in
his/her/their authorized capacity(ies), and that by his/her/their signature(s) on the instrument the
person(s), or the entity upon behalf of which the person(s) acted, executed the instrument.

I certify under PENALTY OF PERJURY under the laws of the State of California that the foregoing paragraph is true and correct.

WITNESS my hand and official seal.

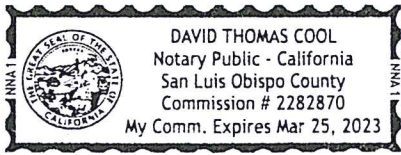

Signature [Signature] (Seal)

ACKNOWLEDGEMENT BY COUNTY OF SANTA BARBARA

This irrevocable Offer to Dedicate real property is acknowledged by the Chair of the Board of Supervisors of the County of Santa Barbara pursuant to the authority conferred by the County of Santa Barbara when it granted Development Plan Permit No. 15DVP-00000-00002, Vesting Tentative Tract Map No. 15TRM-00000-00002/TM 14,812, Road Naming Permit No. 15RDN-00000-00002, and Conditional Use Permit Case No. 15CUP-00000-00006 on January 11, 2017, and the County of Santa Barbara Consents to its recordation. This Acknowledgement is not and shall not be construed as an acceptance of this Offer to Dedicate.

Dated _____, 2021

Bob Nelson
Chair, Board of Supervisors

ATTEST:

Mona Miyasoto
Clerk of the Board of Supervisors

By: _____
Deputy Clerk

APPROVED AS TO FROM:

Michael C. Ghizzoni
County Counsel

By:  _____
Deputy County Counsel

Exhibit A
Offer of Dedication
Legal Description

Those portion of Parcel 1 of Lot Line Adjustment No. 03LLA-00000-00002 described in Certificate of Conformity recorded in Instrument No. 2007-0019420, in the County Recorder's Office, County of Santa Barbara, State of California described as follows:

Parcel 1:

Commencing at the southeast corner of said Parcel 1; thence,

Along the easterly line of said Parcel 1 North 0°25'57" East, a distance of 683.11 feet, said point being on a curve concave to the south having a radius of 312.50 feet, the radial bearing to said point being North 0°26'38" East; thence,

Leaving said easterly line and westerly along said curve through a central angle of 24°42'17", an arc distance of 134.74 feet to a compound curve concave to the southeast having a radius of 822.50 feet, the radial bearing to said point being North 24°15'39" West; thence,

Westerly and southwesterly along said compound curve through a central angle of 3°24'10", an arc distance of 48.85 feet to the Point of Beginning, the radial bearing to said point being North 27°39'49" West; thence,

Continuing southwesterly along said curve through a central angle of 15°56'02", an arc distance of 228.73 feet; thence,

South 46°24'10" West, a distance of 260.80 feet to a curve concave to the northwest having a radius of 477.50 feet; thence,

Southwesterly along said curve through a central angle of 23°48'35", an arc distance of 198.43 feet, the radial bearing to said point being South 19°47'16" East; thence,

North 75°23'04" West, a distance of 18.12 feet; thence,

North 38°16'31" West, a distance of 125.71 feet; thence,

North 45°26'09" West, a distance of 300.17 feet; thence,

North 29°31'35" West, a distance of 80.00 feet; thence,

North 17°49'34" West, a distance of 187.69 feet; thence,

North 65°00'46" West, a distance of 123.18 feet; thence,

North 89°40'49" West, a distance of 88.42 feet to the westerly line of said Parcel 1; thence,

Along the westerly and northerly line of said Parcel 1 the following 4 courses:

North 0°19'15" East, a distance of 148.59 feet; thence,

North 89°33'26" East, a distance of 560.05 feet; thence,

North 0°19'15" East, a distance of 171.93 feet; thence,

North 87°51'59" East, a distance of 63.92 feet to a point being South 87°51'59" West, a distance of 701.36 feet from the northeast corner of said Parcel 1 ; thence,

Leaving the northerly line of said Parcel 1 South 33°18'05" East, a distance of 126.34 feet; thence,

South 33°17'54" East, a distance of 106.57 feet; thence,

South 24°56'20" East, a distance of 121.60 feet; thence,

South 37°40'56" East, a distance of 126.62 feet; thence,

South 76°25'27" East, a distance of 84.36 feet; thence,
South 76°26'20" East, a distance of 108.05 feet; thence,
South 76°24'52" East, a distance of 58.82 feet; thence,
North 86°44'15" East, a distance of 36.50 feet to a curve concave to the east having a radius of 218.50 feet, the radial bearing to said point being South 82°37'56" West; thence,
Southerly along said curve through a central angle of 9°27'38", an arc distance of 36.08 feet to a reverse curve concave to the west having a radius of 24.50 feet, the radial bearing to said point being North 73°10'17" East; thence,
Southerly along said reverse curve through a central angle of 18°03'00", an arc distance of 7.72 feet, the radial bearing to said point being South 88°46'43" East; thence,
South 72°25'10" West, a distance of 12.32 feet; thence,
South 34°17'37" West, a distance of 20.79 feet to the Point of Beginning.

The parcel described contains 11.36 acres more or less and is shown graphically on Exhibit B-1 herein attached.

Parcel 2:

Beginning at the southeast corner of said Parcel 1; thence,
Along the easterly line of said Parcel 1 North 0°25'57" East, a distance of 630.61 feet; thence,
Leaving said easterly line North 89°33'19" West, a distance of 19.71 feet to a curve concave to the south having a radius of 250.00 feet; thence,; thence,
Westerly along said curve through a central angle of 26°11'47", an arc distance of 114.30 feet to a compound curve concave to the southeast having a radius of 777.50 feet, the radial bearing to said point being North 25°45'06" West; thence,
Westerly and southwesterly along said compound curve through a central angle of 17°50'44", an arc distance of 242.16 feet; thence,
southwesterly along said curve South 46°24'10" West, a distance of 260.80 feet to a curve concave to the northwest having a radius of 522.50 feet; thence,
through a central angle of 27°27'20", an arc distance of 250.38 feet, the radial bearing to said point being South 16°08'30" East; thence,
South 18°05'46" East, a distance of 170.04 feet to the southerly line of said Parcel 1; thence,
Along said southerly line of said Parcel 1 South 89°41'01" East, a distance of 674.97 feet to the Point of Beginning.

The parcel described contains 6.89 acres more or less and is shown graphically on Exhibit B-2 herein attached.

Reserving easements for drainage and storm drain purposes lying within Parcel 1 described herein, easements described as follows:

Easement 1:

Beginning at a point being South 46°24'10" West, a distance of 99.07 feet from the northeasterly terminus of the course described as South 46°24'10" West, a distance of 260.80 feet of said Parcel 1 described herein; thence,

North 38°59'00" West, a distance of 102.96 feet; thence,
South 51°01'00" West, a distance of 15.00 feet; thence,
South 38°59'00" East, a distance of 104.17 feet to said course; thence,
North 46°24'10" East, a distance of 15.05 feet to the Point of Beginning.

The parcel described contains 1,554 square feet more or less and is shown graphically on Exhibit B-3 herein attached.

Easement 2:

Beginning at a point being North 17°49'34" West, a distance of 111.35 feet from the southerly terminus of the course described as North 17°49'34" West, a distance of 187.69 feet of said Parcel 1 described herein; thence,
North 54°18'08" East, a distance of 215.48 feet; thence,
North 35°41'52" West, a distance of 18.00 feet; thence,
South 54°18'08" West, a distance of 209.67 feet to said course; thence,
South 17°49'34" East, a distance of 18.91 feet to the Point of Beginning.

The parcel described contains 3,826 square feet more or less and is shown graphically on Exhibit B-3 herein attached.

Easement 3:

Beginning at the northwesterly terminus of the course described as South 33°18'05" East, a distance of 126.34 feet of said Parcel 1 described herein; thence,
South 33°18'05" East, a distance of 17.53 feet; thence,
South 9°55'12" West, a distance of 217.63 feet; thence,
South 79°16'28" West, a distance of 106.10 feet; thence,
North 10°43'32" West, a distance of 15.00 feet; thence,
North 79°16'28" East, a distance of 95.73 feet; thence,
North 9°55'12" East, a distance of 219.39 feet to the northerly line of said Parcel 1 described herein; thence,
North 87°51'59" East, a distance of 3.06 feet to the Point of Beginning.

The parcel described contains 4,814 square feet more or less and is shown graphically on Exhibit B-3 herein attached.



EXHIBIT B-1

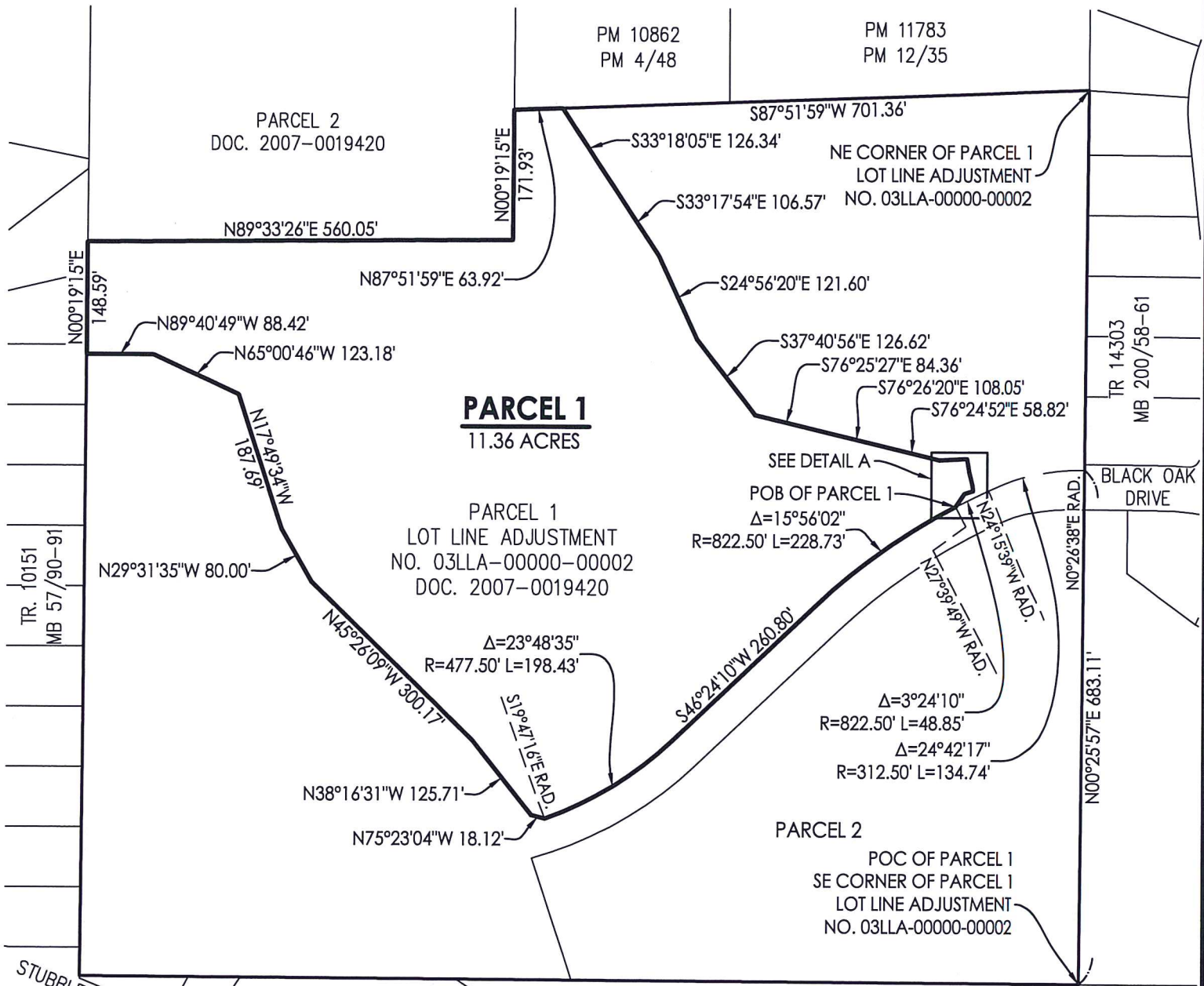

PARCEL 1
11.36 ACRES

PARCEL 1
LOT LINE ADJUSTMENT
NO. 03LLA-00000-00002
DOC. 2007-0019420

PARCEL 2
POB OF PARCEL 1
SE CORNER OF PARCEL 1
LOT LINE ADJUSTMENT
NO. 03LLA-00000-00002

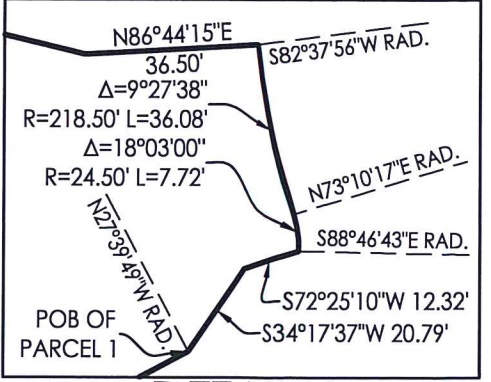

DETAIL A
1" = 40'



Steven B. Webster

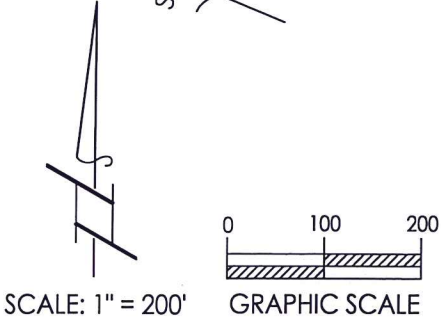
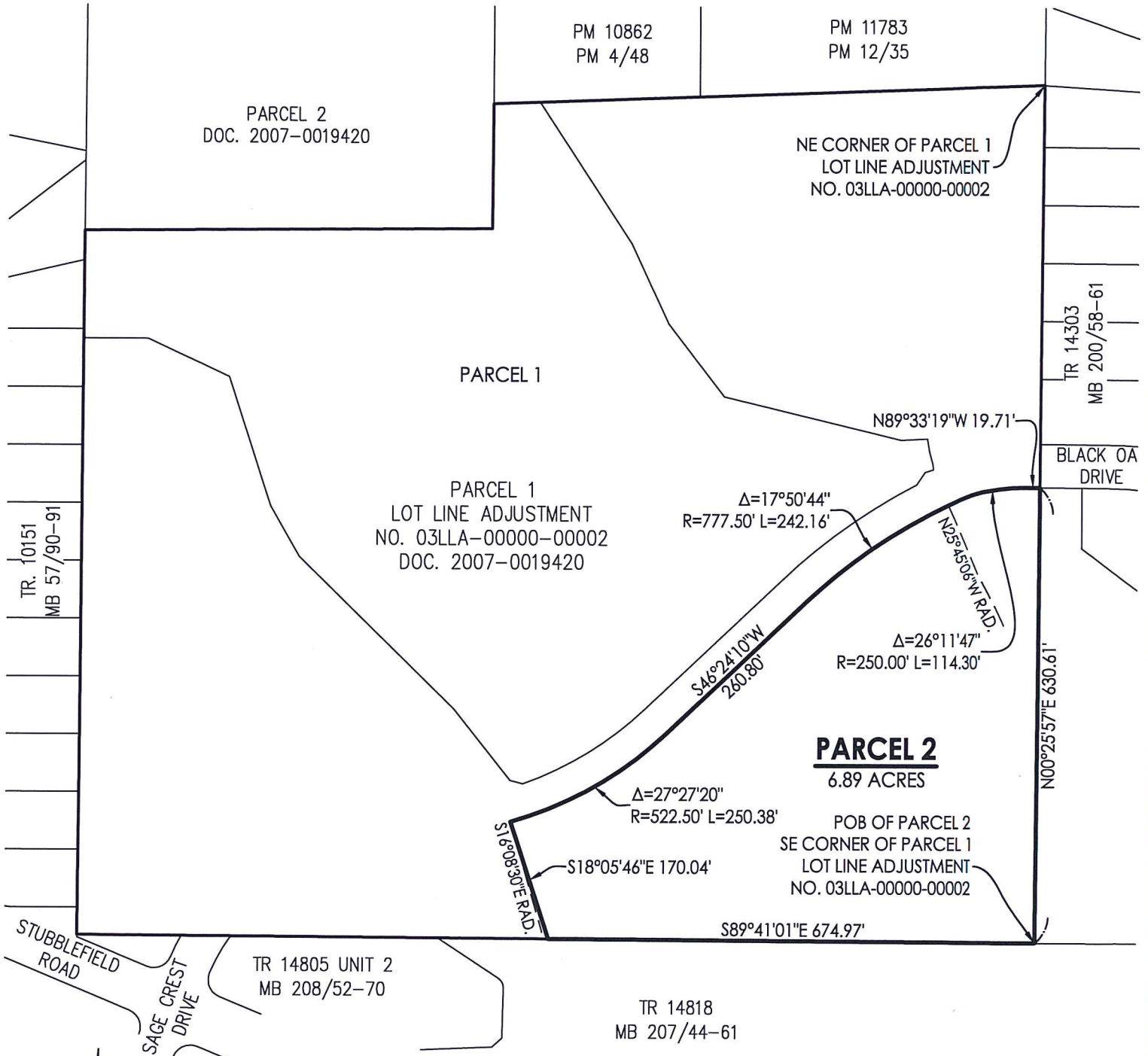
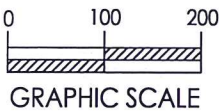

EXHIBIT B-2



SCALE: 1" = 200'



3765 S. Higuera St., Ste. 102 • San Luis Obispo, CA 93401
 p: (805) 543-1794 • f: (805) 543-4609
www.rrmdesign.com



EXHIBIT B-3

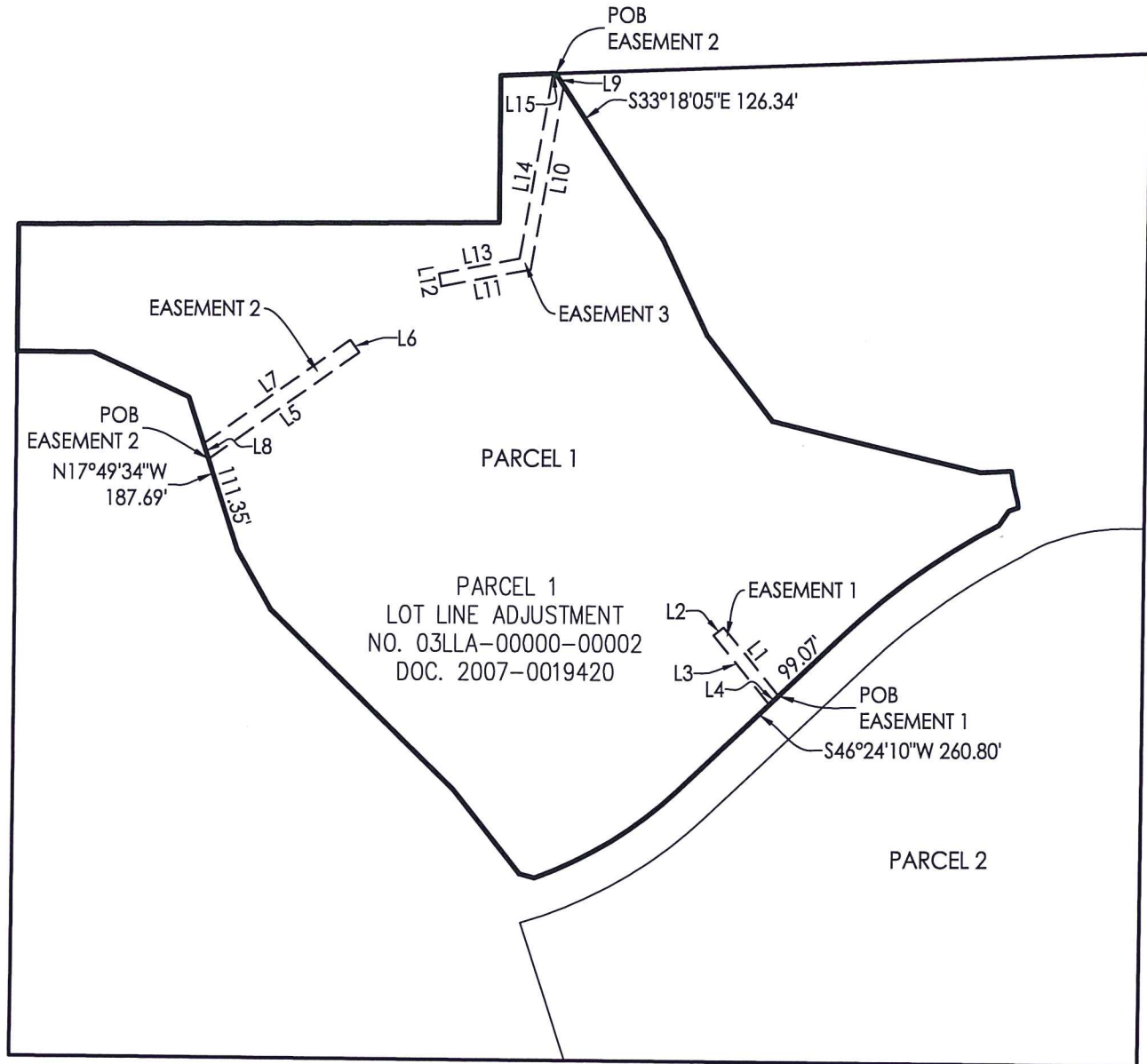

LINE DATA			LINE DATA			LINE DATA		
LINE	DIRECTION	LENGTH	LINE	DIRECTION	LENGTH	LINE	DIRECTION	LENGTH
L1	N38°59'00"W	102.96'	L6	N35°41'52"W	18.00'	L11	S79°16'28"W	106.10'
L2	S51°01'00"W	15.00'	L7	S54°18'08"W	209.67'	L12	N10°43'32"W	15.00'
L3	S38°59'00"E	104.17'	L8	S17°49'34"E	18.91'	L13	N79°16'28"E	95.73'
L4	N46°24'10"E	15.05'	L9	S33°18'05"E	17.53'	L14	N09°55'12"E	219.39'
L5	N54°18'08"E	215.48'	L10	S09°55'12"W	217.63'	L15	N87°51'59"E	3.06'



SCALE: 1" = 200'

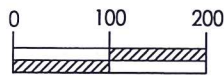

GRAPHIC SCALE



Steven B. Webster



3765 S. Higuera St., Ste. 102 • San Luis Obispo, CA 93401
p: (805) 543-1794 • f: (805) 543-4609

www.rrmdesign.com