



SOUTHERN CALIFORNIA
EDISON[®]

An *EDISON INTERNATIONAL*[®] Company

EROSION AND SEDIMENT CONTROL PLAN (ESCP)

TUNNEL ROAD TRAIL, ROAD AREAS 1-16 AND VARIOUS SPUR ROADS STORM MAINTENANCE AND CLEAN-UP OPERATIONS

Prepared By:

Andrew Price, PE, QSD/P
Michael Baker International
(310) 739-2932
Andrew.J.Price@mbakerintl.com

Preparation Date: February 2023

Reviewed and Approved By:

Lucy Cortez-Johnson, CPESC, QSD/P, CGP ToR
Southern California Edison (SCE)
Environmental Services Department

03/01/2023

Signature and Date

Construction Start Date

March 2023

Construction End Date

April 2023

EMERGENCY CONTACT INFORMATION

For this Project, the Primary Contractor (Henkels and McCoy) has been identified, by Southern California Edison (SCE), as the primary spill clean-up responder, as well as for other waste discharge incidents. In the event of an emergency (e.g. environmental emergencies, hazardous waste release, etc.), the notifications shall be performed using the following information:

1. **Project ESCP Representative (SCE)** – Lucy Cortez-Johnson: (714) 794-7805
 - a. **Field Inspector (Michael Baker International (MBI))** – Andrew Price: (310) 739-2932
2. **Construction Site Representative (SCE)** – Jason Carson: (714) 615-6721
3. **Call 844-GOT-SPIL** (Dispatch 24 hr. Contact): (844) 468-7745

In the event of a hazardous spill at the Project Site: *Within the first hour of the incident*, the person or entity causing or discovering the incident shall contact the ESCP Representative, Lucy Cortez-Johnson, the SCE Construction Site Representative and **844-GOT-SPIL** to notify the on-call Field Environmental Specialist.

Every reasonable effort to immediately contain and clean up hazardous materials releases shall be made. Once the spill has been cleaned up, within one (1) business day, an Incident and Evaluation Report shall be submitted to SCE's ESD at GOTSPILL@sce.com.

INTRODUCTION

This Erosion and Sediment Control Plan (ESCP) has been developed for the Tunnel Road Trail, Road Areas 1-16 and Various Spur Roads Project (Project) within Mission Canyon, in the City and County of Santa Barbara, California. This ESCP has been prepared to protect against potential water quality impacts during construction activities by implementing Best Management Practices (BMPs). BMPs, as identified and described herein, have been selected based on site conditions and anticipated construction activities. Project construction is anticipated to begin as early as March 2023 and be completed in 4 weeks, assuming a 5-day work week. Repairs are expected to be complete by April 2023.

Project Description

Emergency road repairs are required to ensure safe vehicle access to SCE owned facilities, safe emergency vehicle access for wildfire response, and public safety for users of the trail and adjacent property owners/downstream residences. Emergency actions include cleanup of accumulated debris within the existing roadway footprint including rocks, boulders, and sloughed vegetation, filling of impassable ruts and rills, and repair/restoration of existing water bars. These repairs will maintain original line and grade, hydraulic capacity, and original purpose of the facilities.

Vicinity Map

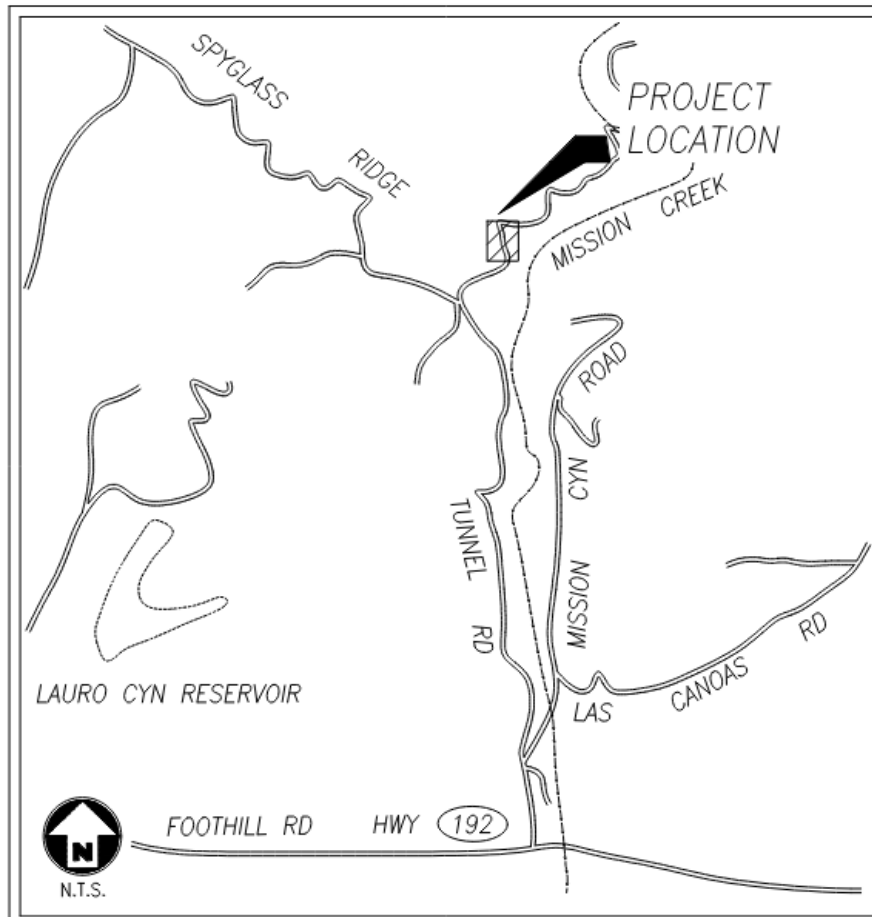

Proposed Maintenance/Construction Activities

All repair work is proposed to be completed within the road prism. No berms nor drains will be added or removed; however, limited repairs to berms adjacent to existing drains may be needed to restore function. Road repair activities include but are not limited to the following:

- Cleanup and restoration of existing roads to provide safe access (RA 1-16, Trail Road areas 1 and 2, and spur road 10)
 - Clean up rockfall and mudslide debris
 - Fill in impassable road ruts and blowouts along the road
 - Cleanup of existing drains to ensure proper drainage
 - Limited repair to existing berms adjacent to existing drains to maintain proper drainage
 - Include a limited number of waterbars to ensure proper drainage control in unpaved sections of the road
 - Waste material hauling. Suitable material will be used for repairs. Review of individual rock(s) from upslope area of rockfall/sloughing and removal when warranted for safe working conditions of personnel

Note: *Figure 2 below was developed to capture representative site features and is not exhaustive. Maintenance needs in areas not depicted in these photos may still exist. Additional maintenance may be required beyond the scope of the photos presented in this document.*

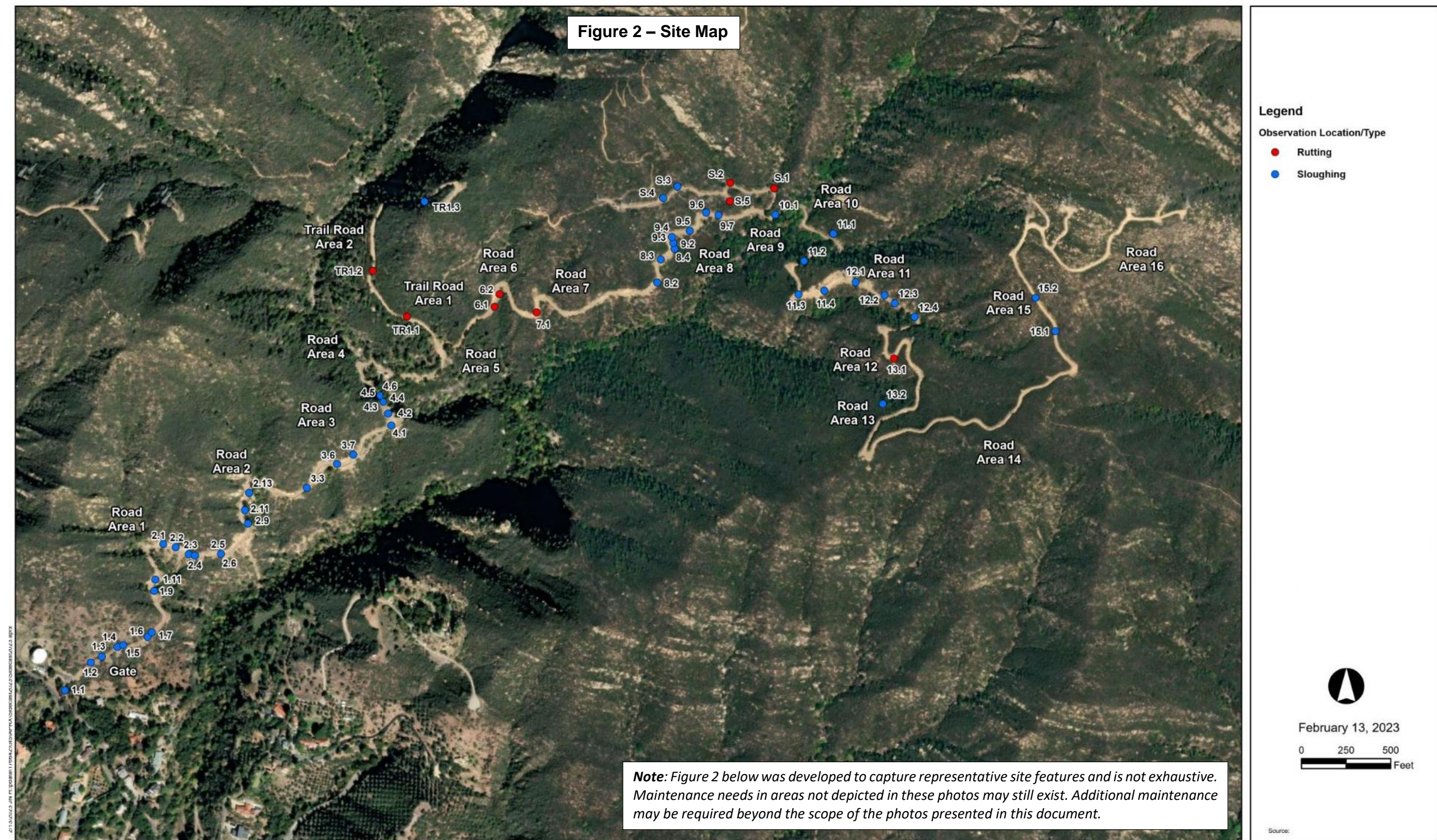

POTENTIAL POLLUTANT SOURCES

SCE will utilize BMP control practices for construction activities in an effort to minimize or eliminate potential pollutants from discharging from the construction sites. For additional details regarding all BMPs selected for this Project, refer to **Best Management Practices** section below.

Construction Activities

The following is a list of proposed construction activities that may have the potential to contribute pollutants in storm water discharges:

- Cleanup of rockfall and mudslide debris
- Fill of road ruts and blowouts
- Cleanup of existing drains
- Repair to existing berms
- Water bar improvements
- Waste material hauling.
- Vehicle tracking

The major potential pollutant sources anticipated during project construction activities is sediment.

Construction Materials

The following is a list of proposed construction materials that may have the potential to contribute pollutants in storm water discharges:

- Rock and Sediment (for onsite reuse)
- Vehicle fluids, including oil, grease, petroleum, and coolants
- Metals and plated products
- Non-biodegradable BMP materials

Construction Wastes

The following is a list of construction wastes that may be generated during proposed work activities and may have the potential to contribute pollutants in storm water discharges:

- Packaging materials including wood, paper and plastic
- General litter (i.e. rubber, Styrofoam, plastic, glass, food waste, etc.)
- Non-hazardous equipment parts
- Sanitary facilities
- Sediment

SAFETY AND TRAINING

The assigned site inspector must be trained in Project-specific water quality procedures and site safety prior to mobilizing onsite. All personnel at the site shall receive training appropriate for individual roles and responsibilities on the Project. Prior to construction, all crews shall receive an ESCP training which will be documented in SCE's CloudCompli Portal. Appropriate personnel shall receive training on ESCP implementation, BMP inspection and maintenance, and record keeping.

Prior to the start of construction all crew members who will work onsite will be given a Workers Environmental Awareness Program (WEAP) Training. To avoid and minimize impacts to special status species, a qualified wildlife biologist may be present during construction. All practices proposed in this ESCP are intended to be compliant with associated permits and can be substituted if deemed necessary. BMP installation/maintenance should be performed with a site biologist, if required.

BEST MANAGEMENT PRACTICES

This section identifies BMPs to be used during construction activities. BMPs are the schedule of activities, prohibitions of practices, maintenance procedures, and other management practices that reduce or eliminate pollutants in storm water discharges and authorized non-storm water discharges. BMPs include treatment requirements, operating procedures and practices to control site runoff, spillage or leaks, waste disposal and drainage from raw material storage. BMP implementation must take into account changing weather conditions, construction activities, and various combinations of BMPs that may be used over the life of the project to maintain compliance with the Clean Water Act. The BMPs specified in this document are the most economical and effective methods to achieve the goal of managing sediment and preventing erosion. This project will include the following construction activities:

- Good Housekeeping and Pollution Prevention
- Maintenance and/or Ground Disturbing Activities
- Concrete Activities
- Site Access and Track Out
- Final Stabilization

Specific BMP factsheets per the California Stormwater Quality Association (CASQA) Handbook, are provided as applicable for the scope of work. The CASQA BMP fact sheets standardize installation techniques that will be implemented based on the scope of construction activities.

Good Housekeeping and Pollution Prevention

Good Housekeeping and Pollution Prevention will be the most effective way to limit the introduction of pollutants during this project. These BMPs must be implemented during all actions and activities required to complete this project. These BMPs should be incorporated into all of the additional activities that follow. It is feasible that during intense rainfall, water will accumulate and pond within the proposed work location. All vehicles and equipment will be removed prior to NOAA forecasted rain event, **greater than 30% OR 0.2" of measurable precipitation** and staged outside of jurisdictional flow paths. Proposed work areas will be compacted, and temporary BMP's will be maintained prior to rain events to ensure water is contained.

All laydown activities will take place within the designated laydown areas. There will be no ground disturbing activities at the proposed laydown location. The proposed laydown area will be used to store equipment, materials required for the construction of this project and contain portable toilets. Perimeter control BMPs will be installed on the downgradient end of the staging areas. Additional activities may include but are not limited to: vehicle fueling, material hauling activities and material delivery.

If the rainfall percentage **increases to 40%** on the three-day forecast all work onsite will be halted at noon, (1) day prior to the rain event to ensure time for the primary contractor (Henkels and McCoy) to implement good housekeeping measures including stockpile management prior to the forecasted rain event.

Maintenance and/or Ground Disturbing Activities

Ground disturbing activities encompass actions that alter the existing soil surface. In the current or natural state, most soil surfaces are compacted and will resist the forces of water and wind. However, once soil surfaces are disturbed, they are prone to erosion and may cause pollutant releases of sediment into downstream waterbodies. The project must minimize ground disturbance as much as possible to limit pollutant risk. Disturbance can be caused by activities such as accessing the project site due to soft soils from recent rain events, during drive and crush access operations, driving on a dirt shoulder/access road at speeds more than 10 mph. BMPs are recommended to manage pollutants associated with ground disturbing activities.

Prior to any ground disturbing work, sediment and erosion control measure materials should be stockpiled on site. Sediment and erosion control measures should be used during all phases of operation where soil, trenching spoils and casting, and sediment and/or debris runoff threatens to enter a watercourse bed, bank, or creek. Examples of sediment and erosion control measures include bioengineering, silt fencing, coir logs, coir rolls, straw waddles. Sediment and erosion control measures should be installed in a manner that prevents erosion of the site and prevents sediment and debris from entering a watercourse. Sediment and erosion control measures should be maintained in good operating condition until the maintenance activities are completed. Maintenance includes, but is not limited to, checking sediment and erosion control measures for trapped or entangled wildlife, removing accumulated sediment, repair and or and replacement of damaged sediment and erosion control measures. Modifications, repairs, and improvements should be made to the sediment and erosion control measures whenever needed to maintain them in good operating condition. If a sediment barrier fails to retain sediment, corrective measures should be employed, and a biological monitor should be notified, immediately.

Disturbed soil areas (if any) associated with construction are to be stabilized through an effective combination of erosion and sediment controls once ground disturbing activities have been completed. Disturbed soil areas associated with site access and laydown areas will be returned to their original state at the end of the project. See Final Stabilization Section below for more details.

Water Crossings (If Necessary)

If temporary watercourse crossings will occur, locations will be clearly indicated with signage or flagging, and sediment and erosion control methods will be used to minimize impacts. When operations at that location end, these erosion control methods should be removed, and the location should be returned to baseline. The installation of temporary watercourse crossings should be installed such that water flow is not impaired. If temporary watercourse crossings are to be used during high seasonal flows, such crossings should accommodate those flows or should be removed before such flows occur. If an existing or new temporary watercourse crossing must be used, the crossing site should be inspected by the qualified biologist for, wildlife, and special-status plant species prior to entering the watercourse. If wildlife has been identified on site either prior to or during project activities and cannot leave of their own volition, the Operations Chief, Debris Group Supervisor, or designee should reference Section 1.6 of the CALOES CDFW Flood Debris Cleanup and Management BMPS, on how to proceed.

Site Access and Track Out

Anytime frequent transition from dirt to paved surfaces occurs, there is the potential for soil/construction debris to be tracked onto a paved surface. It is not practical to install a construction entrance/exit at each location, therefore, frequent street sweeping will be required to control possible track out.

The Contractor will follow the guidelines below to ensure that paved areas remain sediment free as applicable:

- Limit the number of site access points when possible;
- Inspect all construction access points daily for sediment track out;
- Visible sediment tracking shall be swept by hand or with a mechanical sweeper daily;
- Utilize dry sweeping methods (i.e. do NOT use water).
- If necessary, install a stabilized construction entrance/exit where the existing dirt access road transitions to paved streets.

Final Stabilization

This project is intended to return the project area to its original line and grade, hydraulic capacity, and original purpose of the facility. Efforts will be made to limit disturbed area. At the conclusion of project, disturbed area, if any shall be stabilized. Final stabilization shall be met through the following.

- Where no vegetation is present prior to construction, the area shall be returned to its original line and grade and/or compacted to achieve final stabilization.
- Disturbed soil area within the jurisdictional waters will be returned to original line/grade.
- Disturbed laydown areas and/or or access points shall be returned to pre-existing conditions.

A Storm Water Inspector will confirm that all track out has been swept clean, BMPs have been removed, all construction materials and debris have been removed, and final stabilization has been achieved. SCE and/or the Storm Water Inspector will conduct a final inspection to ensure that cleanup and stabilization activities are satisfactorily completed.

CASQA BMP Factsheets

BMP ID	CATEGORY
EC-1	Scheduling of Work Activities
EC-2	Preservation of Existing Surfaces and Vegetation
EC-3	Hydraulic Mulch (if necessary)
EC-7	Geotextiles and Mats
EC-16	Erosion Control/Final Stabilization (if necessary)
NS-1	Water Conservation Practices
NS-5	Clear Water Diversions (if necessary)
NS-9, NS-10	Vehicle/Equipment Fueling and Maintenance
NS-12, NS-13	Concrete Curing and Finishing
SE-1, SE-6, SE-7	Sediment/Perimeter Control BMPs
WE-1	Wind Erosion Control
WM-1	Material Delivery and Storage
WM-2, WM-3	Soil Material and Stockpile Management
WM-4	Spill prevention and Control
WM-5, WM-6, WM-7, WM-8, WM-9	Solid, Hazardous, Soil, Concrete, Septic Waste

CalOES CDFW Flood Debris Cleanup and Management BMPs

All maintenance activities are intended to follow CDFW guidance established in the 2023 CalOES CDFW Flood Debris Cleanup and Management Best Management Practices. See Appendix B for complete details.

BMP Maintenance, Inspection, and Repair

BMP inspections will be conducted to confirm BMPs are being properly installed and maintained.

The following maintenance tasks should be performed on an as-needed basis:

- Removal of sediment from barriers and perimeter controls;
- Emptying/maintenance of waste containers;
- Soil/stockpile material management;
- Other BMP maintenance as defined in each fact sheet.

Inspections should be conducted as follows:

- Weekly
- Pre-Storm
- Post-Storm

No rain event inspections will occur **during storms** due to personnel safety hazards. Copies of completed inspection reports will be kept with this ESCP.

Associated Water Quality Permits

This ESCP has been developed to incorporate requirements associated with additional permits and is not intended to contradict or negate any associated requirement and/or obligations. Please reference associated permits for additional project requirements.

Additional Measures

In addition to measures mentioned in the plan above, the Project will implement the following resource protection measures:

- Training of field personnel and crews will be conducted to ensure they are aware of and understand all requirements prior to the implementation of work or maintenance activities.
- At all times, appropriate types and sufficient quantities of materials shall be maintained on-site to contain any spill or inadvertent release of materials that may cause a condition of pollution or nuisance if the materials reach waters of the United States and/or State.
- Fueling, lubrication, maintenance, storage, and staging of vehicles and equipment must not result in a discharge to any waters of the United States and/or State and shall be located outside of waters of the United States and/or stay in areas where accidental spills are not likely to enter or affect such waters.
- No equipment maintenance, fueling, or storage should occur within or next to a watercourse bed, bank, or channel or lake margin where petroleum products or other pollutants from the equipment may enter these areas.
- If maintenance related materials reach surface waters, appropriate spill response procedures must be initiated as soon as the incident is discovered.
- Maintenance materials and debris from all maintenance work areas shall be removed following completion of the Project.
- Permitted activities must first avoid and then minimize adverse impacts on aquatic resources to the maximum extent practicable.
- The person(s) completing the Project should prevent raw cement, concrete, or washings thereof, asphalt, paint, or other coating material, oil or other petroleum products, or any other substance deleterious to aquatic life from contaminating soil and/or entering a river, stream, lake or other waters of the State. (See Fish and Game Code Section 5650.)
- The person(s) completing the Project should minimize the disturbance or removal of vegetation in completing the work.
- Fire, parking and traffic control best practices will apply.
- Electronic message board will be placed on the tunnel road notifying public of closure and construction duration
- Capstone services will be utilized for fire protection
- Community outreach: SCE will reach out to notify the public via social media, SCE.com, other local trail user groups

APPENDIX A: CASQA BMP FACT SHEETS

Scheduling

EC-1

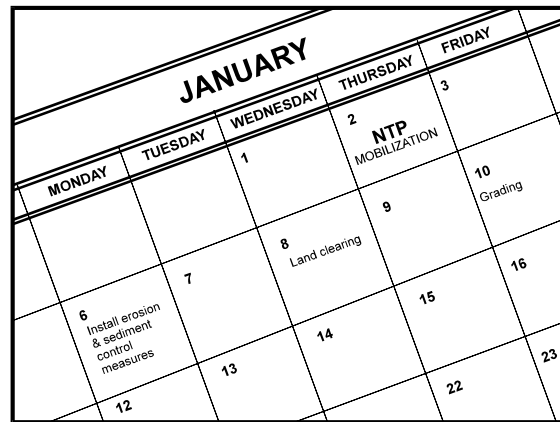

Description and Purpose

Scheduling is the development of a written plan that includes sequencing of construction activities and the implementation of BMPs such as erosion control and sediment control while taking local climate (rainfall, wind, etc.) into consideration. The purpose is to reduce the amount and duration of soil exposed to erosion by wind, rain, runoff, and vehicle tracking, and to perform the construction activities and control practices in accordance with the planned schedule.

Suitable Applications

Proper sequencing of construction activities to reduce erosion potential should be incorporated into the schedule of every construction project especially during rainy season. Use of other, more costly yet less effective, erosion and sediment control BMPs may often be reduced through proper construction sequencing.

Limitations

- Environmental constraints such as nesting season prohibitions reduce the full capabilities of this BMP.

Implementation

- Avoid rainy periods. Schedule major grading operations during dry months when practical. Allow enough time before rainfall begins to stabilize the soil with vegetation or physical means or to install sediment trapping devices.
- Plan the project and develop a schedule showing each phase of construction. Clearly show how the rainy season relates

Categories

EC	Erosion Control	<input checked="" type="checkbox"/>
SE	Sediment Control	<input checked="" type="checkbox"/>
TC	Tracking Control	<input checked="" type="checkbox"/>
WE	Wind Erosion Control	<input checked="" type="checkbox"/>
NS	Non-Stormwater Management Control	
WM	Waste Management and Materials Pollution Control	

Legend:

- Primary Objective
- Secondary Objective

Targeted Constituents

Sediment	<input checked="" type="checkbox"/>
Nutrients	
Trash	
Metals	
Bacteria	
Oil and Grease	
Organics	

Potential Alternatives

None

If User/Subscriber modifies this fact sheet in any way, the CASQA name/logo and footer below must be removed from each page and not appear on the modified version.



Scheduling

EC-1

to soil disturbing and re-stabilization activities. Incorporate the construction schedule into the SWPPP.

- Include on the schedule, details on the rainy season implementation and deployment of:
 - Erosion control BMPs
 - Sediment control BMPs
 - Tracking control BMPs
 - Wind erosion control BMPs
 - Non-stormwater BMPs
 - Waste management and materials pollution control BMPs
- Include dates for activities that may require non-stormwater discharges such as dewatering, sawcutting, grinding, drilling, boring, crushing, blasting, painting, hydro-demolition, mortar mixing, pavement cleaning, etc.
- Work out the sequencing and timetable for the start and completion of each item such as site clearing and grubbing, grading, excavation, paving, foundation pouring utilities installation, etc., to minimize the active construction area during the rainy season.
 - Sequence trenching activities so that most open portions are closed before new trenching begins.
 - Incorporate staged seeding and re-vegetation of graded slopes as work progresses.
 - Schedule establishment of permanent vegetation during appropriate planting time for specified vegetation.
- Non-active areas should be stabilized as soon as practical after the cessation of soil disturbing activities or one day prior to the onset of precipitation.
- Monitor the weather forecast for rainfall.
- When rainfall is predicted, adjust the construction schedule to allow the implementation of soil stabilization and sediment treatment controls on all disturbed areas prior to the onset of rain.
- Be prepared year round to deploy erosion control and sediment control BMPs. Erosion may be caused during dry seasons by un-seasonal rainfall, wind, and vehicle tracking. Keep the site stabilized year round, and retain and maintain rainy season sediment trapping devices in operational condition.
- Apply permanent erosion control to areas deemed substantially complete during the project's defined seeding window.

Costs

Construction scheduling to reduce erosion may increase other construction costs due to reduced economies of scale in performing site grading. The cost effectiveness of scheduling techniques should be compared with the other less effective erosion and sedimentation controls to achieve a cost effective balance.

Scheduling

EC-1

Inspection and Maintenance

- Verify that work is progressing in accordance with the schedule. If progress deviates, take corrective actions.
- Amend the schedule when changes are warranted.
- Amend the schedule prior to the rainy season to show updated information on the deployment and implementation of construction site BMPs.

References

Stormwater Quality Handbooks Construction Site Best Management Practices (BMPs) Manual, State of California Department of Transportation (Caltrans), November 2000.

Stormwater Management for Construction Activities Developing Pollution Prevention Plans and Best Management Practices (EPA 832-R-92-005), U.S. Environmental Protection Agency, Office of Water, September 1992.

Preservation Of Existing Vegetation EC-2

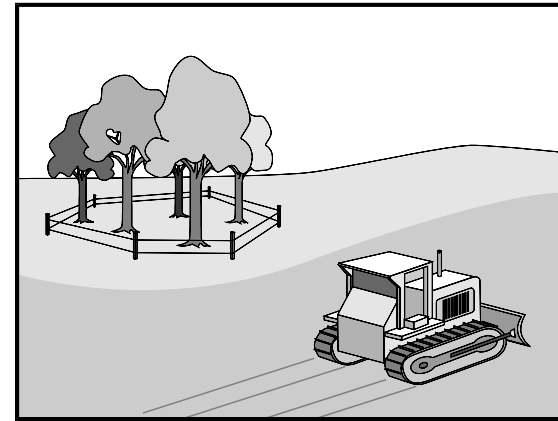

Description and Purpose

Carefully planned preservation of existing vegetation minimizes the potential of removing or injuring existing trees, vines, shrubs, and grasses that protect soil from erosion.

Suitable Applications

Preservation of existing vegetation is suitable for use on most projects. Large project sites often provide the greatest opportunity for use of this BMP. Suitable applications include the following:

- Areas within the site where no construction activity occurs, or occurs at a later date. This BMP is especially suitable to multi year projects where grading can be phased.
- Areas where natural vegetation exists and is designated for preservation. Such areas often include steep slopes, watercourse, and building sites in wooded areas.
- Areas where local, state, and federal government require preservation, such as vernal pools, wetlands, marshes, certain oak trees, etc. These areas are usually designated on the plans, or in the specifications, permits, or environmental documents.
- Where vegetation designated for ultimate removal can be temporarily preserved and be utilized for erosion control and sediment control.

Categories

EC	Erosion Control	<input checked="" type="checkbox"/>
SE	Sediment Control	
TC	Tracking Control	
WE	Wind Erosion Control	
NS	Non-Stormwater Management Control	
WM	Waste Management and Materials Pollution Control	

Legend:

- Primary Objective
- Secondary Objective

Targeted Constituents

Sediment	<input checked="" type="checkbox"/>
Nutrients	
Trash	
Metals	
Bacteria	
Oil and Grease	
Organics	

Potential Alternatives

None

If User/Subscriber modifies this fact sheet in any way, the CASQA name/logo and footer below must be removed from each page and not appear on the modified version.



Preservation Of Existing Vegetation EC-2

Limitations

- Requires forward planning by the owner/developer, contractor, and design staff.
- Limited opportunities for use when project plans do not incorporate existing vegetation into the site design.
- For sites with diverse topography, it is often difficult and expensive to save existing trees while grading the site satisfactory for the planned development.

Implementation

The best way to prevent erosion is to not disturb the land. In order to reduce the impacts of new development and redevelopment, projects may be designed to avoid disturbing land in sensitive areas of the site (e.g., natural watercourses, steep slopes), and to incorporate unique or desirable existing vegetation into the site's landscaping plan. Clearly marking and leaving a buffer area around these unique areas during construction will help to preserve these areas as well as take advantage of natural erosion prevention and sediment trapping.

Existing vegetation to be preserved on the site must be protected from mechanical and other injury while the land is being developed. The purpose of protecting existing vegetation is to ensure the survival of desirable vegetation for shade, beautification, and erosion control. Mature vegetation has extensive root systems that help to hold soil in place, thus reducing erosion. In addition, vegetation helps keep soil from drying rapidly and becoming susceptible to erosion. To effectively save existing vegetation, no disturbances of any kind should be allowed within a defined area around the vegetation. For trees, no construction activity should occur within the drip line of the tree.

Timing

- Provide for preservation of existing vegetation prior to the commencement of clearing and grubbing operations or other soil disturbing activities in areas where no construction activity is planned or will occur at a later date.

Design and Layout

- Mark areas to be preserved with temporary fencing. Include sufficient setback to protect roots.
 - Orange colored plastic mesh fencing works well.
 - Use appropriate fence posts and adequate post spacing and depth to completely support the fence in an upright position.
- Locate temporary roadways, stockpiles, and layout areas to avoid stands of trees, shrubs, and grass.
- Consider the impact of grade changes to existing vegetation and the root zone.
- Maintain existing irrigation systems where feasible. Temporary irrigation may be required.
- Instruct employees and subcontractors to honor protective devices. Prohibit heavy equipment, vehicular traffic, or storage of construction materials within the protected area.

Preservation Of Existing Vegetation EC-2

Costs

There is little cost associated with preserving existing vegetation if properly planned during the project design, and these costs may be offset by aesthetic benefits that enhance property values. During construction, the cost for preserving existing vegetation will likely be less than the cost of applying erosion and sediment controls to the disturbed area. Replacing vegetation inadvertently destroyed during construction can be extremely expensive, sometimes in excess of \$10,000 per tree.

Inspection and Maintenance

During construction, the limits of disturbance should remain clearly marked at all times. Irrigation or maintenance of existing vegetation should be described in the landscaping plan. If damage to protected trees still occurs, maintenance guidelines described below should be followed:

- Verify that protective measures remain in place. Restore damaged protection measures immediately.
- Serious tree injuries shall be attended to by an arborist.
- Damage to the crown, trunk, or root system of a retained tree shall be repaired immediately.
- Trench as far from tree trunks as possible, usually outside of the tree drip line or canopy. Curve trenches around trees to avoid large roots or root concentrations. If roots are encountered, consider tunneling under them. When trenching or tunneling near or under trees to be retained, place tunnels at least 18 in. below the ground surface, and not below the tree center to minimize impact on the roots.
- Do not leave tree roots exposed to air. Cover exposed roots with soil as soon as possible. If soil covering is not practical, protect exposed roots with wet burlap or peat moss until the tunnel or trench is ready for backfill.
- Cleanly remove the ends of damaged roots with a smooth cut.
- Fill trenches and tunnels as soon as possible. Careful filling and tamping will eliminate air spaces in the soil, which can damage roots.
- If bark damage occurs, cut back all loosened bark into the undamaged area, with the cut tapered at the top and bottom and drainage provided at the base of the wood. Limit cutting the undamaged area as much as possible.
- Aerate soil that has been compacted over a trees root zone by punching holes 12 in. deep with an iron bar, and moving the bar back and forth until the soil is loosened. Place holes 18 in. apart throughout the area of compacted soil under the tree crown.
- Fertilization
 - Fertilize stressed or damaged broadleaf trees to aid recovery.
 - Fertilize trees in the late fall or early spring.

Preservation Of Existing Vegetation EC-2

- Apply fertilizer to the soil over the feeder roots and in accordance with label instructions, but never closer than 3 ft to the trunk. Increase the fertilized area by one-fourth of the crown area for conifers that have extended root systems.
- Retain protective measures until all other construction activity is complete to avoid damage during site cleanup and stabilization.

References

County of Sacramento Tree Preservation Ordinance, September 1981.

Stormwater Quality Handbooks Construction Site Best Management Practices (BMPs) Manual, State of California Department of Transportation (Caltrans), November 2000.

Stormwater Management of the Puget Sound Basin, Technical Manual, Publication #91-75, Washington State Department of Ecology, February 1992.

Water Quality Management Plan for The Lake Tahoe Region, Volume II, Handbook of Management Practices, Tahoe Regional Planning Agency, November 1988.

Hydraulic Mulch

EC-3

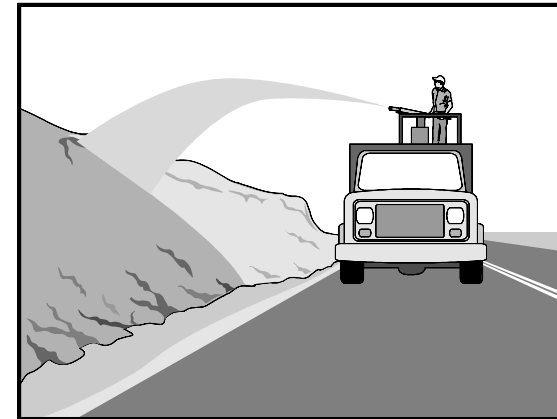

Description and Purpose

Hydraulic Mulch consists of various types of fibrous materials mixed with water and sprayed onto the soil surface in slurry form to provide a layer of temporary protection from wind and water erosion.

Suitable Applications

Hydraulic mulch as a temporary, stand alone, erosion control BMP is suitable for disturbed areas that require temporary protection from wind and water erosion until permanent soil stabilization activities commence. Examples include:

- Rough-graded areas that will remain inactive for longer than permit-required thresholds (e.g., 14 days) or otherwise require stabilization to minimize erosion or prevent sediment discharges.
- Soil stockpiles.
- Slopes with exposed soil between existing vegetation such as trees or shrubs.
- Slopes planted with live, container-grown vegetation or plugs.
- Slopes burned by wildfire.

Categories

EC	Erosion Control	<input checked="" type="checkbox"/>
SE	Sediment Control	
TC	Tracking Control	
WE	Wind Erosion Control	<input checked="" type="checkbox"/>
NS	Non-Stormwater Management Control	
WM	Waste Management and Materials Pollution Control	

Legend:

- Primary Category
- Secondary Category

Targeted Constituents

Sediment	<input checked="" type="checkbox"/>
Nutrients	
Trash	
Metals	
Bacteria	
Oil and Grease	
Organics	

Potential Alternatives

- EC-4 Hydroseeding
- EC-5 Soil Binders
- EC-6 Straw Mulch
- EC-7 Geotextiles and Mats
- EC-8 Wood Mulching
- EC-14 Compost Blanket
- EC-16 Non-Vegetative Stabilization

If User/Subscriber modifies this fact sheet in any way, the CASQA name/logo and footer below must be removed from each page and not appear on the modified version.



Hydraulic mulch can also be applied to augment other erosion control BMPs such as:

- In conjunction with straw mulch (see EC-6 Straw Mulch) where the rate of hydraulic mulch is reduced to 100-500 lbs per acre and the slurry is applied over the straw as a tackifying agent to hold the straw in place.
- Supplemental application of soil amendments, such as fertilizer, lime, gypsum, soil bio-stimulants or compost.

Limitations

In general, hydraulic mulch is not limited by slope length, gradient or soil type. However, the following limitations typically apply:

- Most hydraulic mulch applications, particularly bonded fiber matrices (BFMs), require at least 24 hours to dry before rainfall occurs.
- Temporary applications (i.e., without a vegetative component) may require a second application in order to remain effective for an entire rainy season.
- Treatment areas must be accessible to hydraulic mulching equipment.
- Availability of water sources in remote areas for mixing and application.
- As a stand-alone temporary BMP, hydraulic mulches may need to be re-applied to maintain their erosion control effectiveness, typically after 6-12 months depending on the type of mulch used.
- Availability of hydraulic mulching equipment may be limited just prior to the rainy season and prior to storms due to high demand.
- Cellulose fiber mulches alone may not perform well on steep slopes or in coarse soils.
- This BMP consists of a mixture of several constituents (e.g., fibers/mulches, tackifiers, and other chemical constituents), some of which may be proprietary and may come pre-mixed by the manufacturer. The water quality impacts of these constituents are relatively unknown and some may have water quality impacts due to their chemical makeup. Refer to specific chemical properties identified in the product Material Safety Data Sheet; products should be evaluated for project-specific implementation by the SWPPP Preparer. Refer to factsheet EC-05 for further guidance on selecting soil binders.

Implementation

- Where feasible, it is preferable to prepare soil surfaces prior to application by roughening embankments and fill areas with a crimping or punching type roller or by track walking.
- The majority of hydraulic mulch applications do not necessarily require surface/soil preparation (See EC-15 Soil Preparation) although in almost every case where re-vegetation is included as part of the practice, soil preparation can be beneficial. One of the advantages of hydraulic mulch over other erosion control methods is that it can be applied in areas where soil preparation is precluded by site conditions, such as steep slopes, rocky soils, or inaccessibility.

- Avoid mulch over spray onto roads, sidewalks, drainage channels, existing vegetation, etc.
- Hydraulic mulching is generally performed utilizing specialized machines that have a large water-holding/mixing tank and some form of mechanical agitation or other recirculation method to keep water, mulch and soil amendments in suspension. The mixed hydraulic slurry can be applied from a tower sprayer on top of the machine or by extending a hose to areas remote from the machine.
- Where possible apply hydraulic mulch from multiple directions to adequately cover the soil. Application from a single direction can result in shadowing, uneven coverage and failure of the BMP.
- Hydraulic mulch can also include a vegetative component, such as seed, rhizomes, or stolons (see EC-4 Hydraulic Seed).
- Typical hydraulic mulch application rates range from 2,000 pounds per acre for standard mulches (SMs) to 3,500 pounds per acre for BFMs. However, the required amount of hydraulic mulch to provide adequate coverage of exposed topsoil may appear to exceed the standard rates when the roughness of the soil surface is changed due to soil preparation methods (see EC-15 Soil Preparation) or by slope gradient.
- Other factors such as existing soil moisture and soil texture can have a profound effect on the amount of hydraulic mulch required (i.e. application rate) applied to achieve an erosion-resistant covering.
- Avoid use of mulch without a tackifier component, especially on slopes.
- Mulches used in the hydraulic mulch slurry can include:
 - Cellulose fiber
 - Thermally-processed wood fibers
 - Cotton
 - Synthetics
 - Compost (see EC-14, Compost Blanket)
- Additional guidance on the comparison and selection of temporary slope stabilization methods is provided in Appendix F of the Handbook.

Categories of Hydraulic Mulches

Standard Hydraulic Mulch (SM)

Standard hydraulic mulches are generally applied at a rate of 2,000 pounds per acre and are manufactured containing around 5% tackifier (i.e. soil binder), usually a plant-derived guar or psyllium type. Most standard mulches are green in color derived from food-color based dyes.

Hydraulic Matrices (HM) and Stabilized Fiber Matrices (SFM)

Hydraulic matrices and stabilized fiber matrices are slurries which contain increased levels of tackifiers/soil binders; usually 10% or more by weight. HMs and SFMs have improved performance compared to a standard hydraulic mulch (SM) because of the additional percentage of tackifier and because of their higher application rates, typically 2,500 – 4,000 pounds per acre. Hydraulic matrices can include a mixture of fibers, for example, a 50/50 blend of paper and wood fiber. In the case of an SFM, the tackifier/soil binder is specified as a polyacrylamide (PAM).

Bonded Fiber Matrix (BFM)

Bonded fiber matrices (BFMs) are hydraulically-applied systems of fibers, adhesives (typically guar based) and chemical cross-links. Upon drying, the slurry forms an erosion-resistant blanket that prevents soil erosion and promotes vegetation establishment. The cross-linked adhesive in the BFM should be biodegradable and should not dissolve or disperse upon re-wetting. BFMs are typically applied at rates from 3,000 to 4,000 lbs/acre based on the manufacturer's recommendation. BFMs should not be applied immediately before, during or immediately after rainfall or if the soil is saturated. Depending on the product, BFMs typically require 12 to 24 hours to dry and become effective.

Mechanically-Bonded Fiber Matrices (MBFM)

Mechanically-bonded fiber matrices (MBFMs) are hydraulically applied systems similar to BFM that use crimped synthetic fibers and PAM and are typically applied to a slope at a higher application rate than a standard BFM.

Hydraulic Compost Matrix (HCM)

Hydraulic compost matrix (HCM) is a field-derived practice whereby finely graded or sifted compost is introduced into the hydraulic mulch slurry. A guar-type tackifier can be added for steeper slope applications as well as any specified seed mixtures. A HCM can help to accelerate seed germination and growth. HCMs are particularly useful as an in-fill for three-dimensional re-vegetation geocomposites, such as turf reinforcement mats (TRM) (see EC-7 Geotextiles and Mats).

Costs

Average installed costs for hydraulic mulch categories are provided in Table 1, below.

**Table 1
HYDRAULIC MULCH BMPs
INSTALLED COSTS**

BMP	Installed Cost/Acre
Standard Hydraulic Mulching (SM)	\$1,700 - \$3,600 per acre
Hydraulic Matrices (HM) and Stabilized Fiber Matrices	
Guar-based	\$2,000 - \$4,000 per acre
PAM-based	\$2,500 - \$5,610 per acre
Bonded Fiber Matrix (BFM)	\$3,900 - \$6,900 per acre
Mechanically Bonded Fiber Matrix (MBFM)	\$4,500 - \$6,000 per acre
Hydraulic Compost Matrix (HCM)	\$3,000 - \$3,500 per acre

Source: Cost information received from individual product manufacturers solicited by Geosyntec Consultants (2004)

Inspection and Maintenance

- Maintain an unbroken, temporary mulched ground cover throughout the period of construction when the soils are not being reworked.
- BMPs must be inspected in accordance with General Permit requirements for the associated project type and risk level. It is recommended that at a minimum, BMPs be inspected weekly, prior to forecasted rain events, daily during extended rain events, and after the conclusion of rain events.
- Areas where erosion is evident should be repaired and BMPs re-applied as soon as possible. Care should be exercised to minimize the damage to protected areas while making repairs, as any area damaged will require re-application of BMPs.
- Compare the number of bags or weight of applied mulch to the area treated to determine actual application rates and compliance with specifications.

References

Soil Stabilization BMP Research for Erosion and Sediment Controls: Cost Survey Technical Memorandum, State of California Department of Transportation (Caltrans), July 2007.

Controlling Erosion of Construction Sites, Agricultural Information #347, U.S. Department of Agriculture (USDA), Natural Resources Conservation Service (NRCS) (formerly Soil Conservation Service – SCS).

Guides for Erosion and Sediment Control in California, USDA Soils Conservation Service, January 1991.

Manual of Standards of Erosion and Sediment Control Measures, Association of Bay Area Governments, May 1995.

Sedimentation and Erosion Control, An Inventory of Current Practices Draft, US EPA, April 1990.

Soil Erosion by Water, Agriculture Information Bulletin #513, U.S. Department of Agriculture, Soil Conservation Service.

Stormwater Quality Handbooks Construction Site Best Management Practices (BMPs) Manual, State of California Department of Transportation (Caltrans), March 2003.

Guidance Document: Soil Stabilization for Temporary Slopes, State of California Department of Transportation (Caltrans), November 1999

Stormwater Management of the Puget Sound Basin, Technical Manual, Publication #91-75, Washington State Department of Ecology, February 1992.

Water Quality Management Plan for the Lake Tahoe Region, Volume II, Handbook of Management Practices, Tahoe Regional Planning Agency, November 1988.

Geotextiles and Mats

EC-7

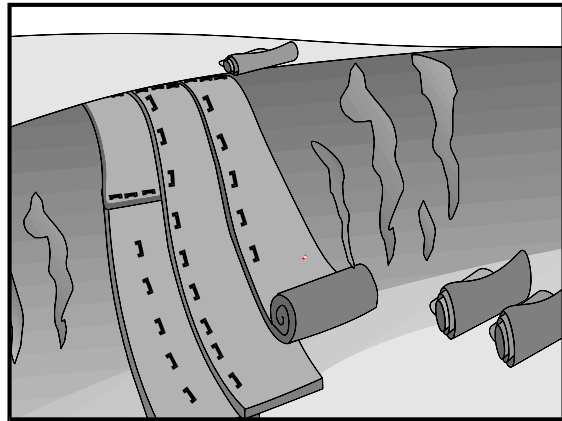

Description and Purpose

Mattings, or Rolled Erosion Control Products (RECPs), can be made of natural or synthetic materials or a combination of the two. RECPs are used to cover the soil surface to reduce erosion from rainfall impact, hold soil in place, and absorb and hold moisture near the soil surface. Additionally, RECPs may be used to stabilize soils until vegetation is established or to reinforce non-woody surface vegetation.

Suitable Applications

RECPs are typically applied on slopes where erosion hazard is high and vegetation will be slow to establish. Mattings are also used on stream banks, swales and other drainage channels where moving water at velocities between 3 ft/s and 6 ft/s are likely to cause scour and wash out new vegetation, and in areas where the soil surface is disturbed and where existing vegetation has been removed. RECPs may also be used when seeding cannot occur (e.g., late season construction and/or the arrival of an early rain season). RECPs should be considered when the soils are fine grained and potentially erosive. RECPs should be considered in the following situations.

- Steep slopes, generally steeper than 3:1 (H:V)
- Slopes where the erosion potential is high
- Slopes and disturbed soils where mulch must be anchored
- Disturbed areas where plants are slow to develop

Categories

EC	Erosion Control	<input checked="" type="checkbox"/>
SE	Sediment Control	
TC	Tracking Control	
WE	Wind Erosion Control	<input checked="" type="checkbox"/>
NS	Non-Stormwater Management Control	
WM	Waste Management and Materials Pollution Control	

Legend:

- Primary Category
- Secondary Category

Targeted Constituents

Sediment	<input checked="" type="checkbox"/>
Nutrients	
Trash	
Metals	
Bacteria	
Oil and Grease	
Organics	

Potential Alternatives

- EC-3 Hydraulic Mulch
- EC-4 Hydroseeding

If User/Subscriber modifies this fact sheet in any way, the CASQA name/logo and footer below must be removed from each page and not appear on the modified version.



Geotextiles and Mats

EC-7

- Channels with flows exceeding 3.3 ft/s
- Channels to be vegetated
- Stockpiles
- Slopes adjacent to water bodies

Limitations

- RECP installed costs are generally higher than other erosion control BMPs, limiting their use to areas where other BMPs are ineffective (e.g. channels, steep slopes).
- RECPs may delay seed germination, due to reduction in soil temperature.
- RECPs are generally not suitable for excessively rocky sites or areas where the final vegetation will be mowed (since staples and netting can catch in mowers). If a staple or pin cannot be driven into the soil because the underlying soil is too hard or rocky, then an alternative BMP should be selected.
- If used for temporary erosion control, RECPs should be removed and disposed of prior to application of permanent soil stabilization measures.
- The use of plastic should be limited to covering stockpiles or very small graded areas for short periods of time (such as through one imminent storm event) until more environmentally friendly measures, such as seeding and mulching, may be installed.
 - Plastic sheeting is easily vandalized, easily torn, photodegradable, and must be disposed of at a landfill.
 - Plastic sheeting results in 100% runoff, which may cause serious erosion problems in the areas receiving the increased flow.
- RECPs may have limitations based on soil type, slope gradient, or channel flow rate; consult the manufacturer for proper selection.
- Not suitable for areas that have foot traffic (tripping hazard) – e.g., pad areas around buildings under construction.
- RECPs that incorporate a plastic netting (e.g. straw blanket typically uses a plastic netting to hold the straw in place) may not be suitable near known wildlife habitat. Wildlife can become trapped in the plastic netting.
- RECPs may have limitations in extremely windy climates. However, when RECPs are properly trenched at the top and bottom and stapled in accordance with the manufacturer's recommendations, problems with wind can be minimized.

Implementation

Material Selection

- Natural RECPs have been found to be effective where re-vegetation will be provided by re-seeding. The choice of material should be based on the size of area, side slopes, surface conditions such as hardness, moisture, weed growth, and availability of materials.
- Additional guidance on the comparison and selection of temporary slope stabilization methods is provided in Appendix F of the Handbook.
- The following natural and synthetic RECPs are commonly used:

Geotextiles

- Material can be a woven or a non-woven polypropylene fabric with minimum thickness of 0.06 in., minimum width of 12 ft and should have minimum tensile strength of 150 lbs (warp), 80 lbs (fill) in conformance with the requirements in ASTM Designation: D 4632. The permittivity of the fabric should be approximately 0.07 sec^{-1} in conformance with the requirements in ASTM Designation: D4491. The fabric should have an ultraviolet (UV) stability of 70 percent in conformance with the requirements in ASTM designation: D4355. Geotextile blankets must be secured in place with wire staples or sandbags and by keying into tops of slopes to prevent infiltration of surface waters under geotextile. Staples should be made of minimum 11 gauge steel wire and should be U-shaped with 8 in. legs and 2 in. crown.
- Geotextiles may be reused if they are suitable for the use intended.

Plastic Covers

- Generally plastic sheeting should only be used as stockpile covering or for very small graded areas for short periods of time (such as through one imminent storm event). If plastic sheeting must be used, choose a plastic that will withstand photo degradation.
- Plastic sheeting should have a minimum thickness of 6 mils, and must be keyed in at the top of slope (when used as a temporary slope protection) and firmly held in place with sandbags or other weights placed no more than 10 ft apart. Seams are typically taped or weighted down their entire length, and there should be at least a 12 in. to 24 in. overlap of all seams. Edges should be embedded a minimum of 6 in. in soil (when used as a temporary slope protection).
- All sheeting must be inspected periodically after installation and after significant rainstorms to check for erosion, undermining, and anchorage failure. Any failures must be repaired immediately. If washout or breakages occur, the material should be re-installed after repairing the damage to the slope.

Erosion Control Blankets/Mats

- Biodegradable RECPs are typically composed of jute fibers, curled wood fibers, straw, coconut fiber, or a combination of these materials. In order for an RECP to be considered 100% biodegradable, the netting, sewing or adhesive system that holds the biodegradable mulch fibers together must also be biodegradable. See typical installation details at the end of this fact sheet.

- **Jute** is a natural fiber that is made into a yarn that is loosely woven into a biodegradable mesh. The performance of jute as a stand-alone RECP is low. Most other RECPs outperform jute as a temporary erosion control product and therefore jute is not commonly used. It is designed to be used in conjunction with vegetation. The material is supplied in rolled strips, which should be secured to the soil with U-shaped staples or stakes in accordance with manufacturers' recommendations.
- **Excelsior** (curled wood fiber) blanket material should consist of machine produced mats of curled wood excelsior with 80 percent of the fiber 6 in. or longer. The excelsior blanket should be of consistent thickness. The wood fiber must be evenly distributed over the entire area of the blanket. The top surface of the blanket should be covered with a photodegradable extruded plastic mesh. The blanket should be smolder resistant without the use of chemical additives and should be non-toxic and non-injurious to plant and animal life. Excelsior blankets should be furnished in rolled strips, a minimum of 48 in. wide, and should have an average weight of 0.8 lb/yd^2 , ± 10 percent, at the time of manufacture. Excelsior blankets must be secured in place with wire staples. Staples should be made of minimum 11 gauge steel wire and should be U-shaped with 8 in. legs and 2 in. crown.
- **Straw blanket** should be machine produced mats of straw with a lightweight biodegradable netting top layer. The straw should be attached to the netting with biodegradable thread or glue strips. The straw blanket should be of consistent thickness. The straw should be evenly distributed over the entire area of the blanket. Straw blanket should be furnished in rolled strips a minimum of 6.5 ft wide, a minimum of 80 ft long and a minimum of 0.5 lb/yd^2 . Straw blankets must be secured in place with wire staples. Staples should be made of minimum 11 gauge steel wire and should be U-shaped with 8 in. legs and 2 in. crown.
- **Wood fiber blanket** is composed of biodegradable fiber mulch with extruded plastic netting held together with adhesives. The material is designed to enhance re-vegetation. The material is furnished in rolled strips, which must be secured to the ground with U-shaped staples or stakes in accordance with manufacturers' recommendations.
- **Coconut fiber blanket** should be a machine produced mat of 100 percent coconut fiber with biodegradable netting on the top and bottom. The coconut fiber should be attached to the netting with biodegradable thread or glue strips. The coconut fiber blanket should be of consistent thickness. The coconut fiber should be evenly distributed over the entire area of the blanket. Coconut fiber blanket should be furnished in rolled strips with a minimum of 6.5 ft wide, a minimum of 80 ft. long and a minimum of 0.5 lb/yd^2 . Coconut fiber blankets must be secured in place with wire staples. Staples should be made of minimum 11 gauge steel wire and should be U-shaped with 8 in. legs and 2 in. crown.
- **Coconut fiber mesh** is a thin permeable membrane made from coconut or corn fiber that is spun into a yarn and woven into a biodegradable mat. It is designed to be used in conjunction with vegetation and typically has longevity of several years. The material is supplied in rolled strips, which must be secured to the soil with U-shaped staples or stakes in accordance with manufacturers' recommendations.

- **Straw coconut fiber blanket** should be machine produced mats of 70 percent straw and 30 percent coconut fiber with a biodegradable netting top layer and a biodegradable bottom net. The straw and coconut fiber should be attached to the netting with biodegradable thread or glue strips. The straw coconut fiber blanket should be of consistent thickness. The straw and coconut fiber should be evenly distributed over the entire area of the blanket. Straw coconut fiber blanket should be furnished in rolled strips a minimum of 6.5 ft wide, a minimum of 80 ft long and a minimum of 0.5 lb/yd². Straw coconut fiber blankets must be secured in place with wire staples. Staples should be made of minimum 11 gauge steel wire and should be U-shaped with 8 in. legs and 2 in. crown.
- Non-biodegradable RECPs are typically composed of polypropylene, polyethylene, nylon or other synthetic fibers. In some cases, a combination of biodegradable and synthetic fibers is used to construct the RECP. Netting used to hold these fibers together is typically non-biodegradable as well.
- **Plastic netting** is a lightweight biaxially oriented netting designed for securing loose mulches like straw or paper to soil surfaces to establish vegetation. The netting is photodegradable. The netting is supplied in rolled strips, which must be secured with U-shaped staples or stakes in accordance with manufacturers' recommendations.
- **Plastic mesh** is an open weave geotextile that is composed of an extruded synthetic fiber woven into a mesh with an opening size of less than ¼ in. It is used with re-vegetation or may be used to secure loose fiber such as straw to the ground. The material is supplied in rolled strips, which must be secured to the soil with U-shaped staples or stakes in accordance with manufacturers' recommendations.
- **Synthetic fiber with netting** is a mat that is composed of durable synthetic fibers treated to resist chemicals and ultraviolet light. The mat is a dense, three dimensional mesh of synthetic (typically polyolefin) fibers stitched between two polypropylene nets. The mats are designed to be re-vegetated and provide a permanent composite system of soil, roots, and geomatrix. The material is furnished in rolled strips, which must be secured with U-shaped staples or stakes in accordance with manufacturers' recommendations.
- **Bonded synthetic fibers** consist of a three dimensional geomatrix nylon (or other synthetic) matting. Typically it has more than 90 percent open area, which facilitates root growth. It's tough root reinforcing system anchors vegetation and protects against hydraulic lift and shear forces created by high volume discharges. It can be installed over prepared soil, followed by seeding into the mat. Once vegetated, it becomes an invisible composite system of soil, roots, and geomatrix. The material is furnished in rolled strips that must be secured with U-shaped staples or stakes in accordance with manufacturers' recommendations.
- **Combination synthetic and biodegradable RECPs** consist of biodegradable fibers, such as wood fiber or coconut fiber, with a heavy polypropylene net stitched to the top and a high strength continuous filament geomatrix or net stitched to the bottom. The material is designed to enhance re-vegetation. The material is furnished in rolled strips,

which must be secured with U-shaped staples or stakes in accordance with manufacturers' recommendations.

Site Preparation

- Proper soil preparation is essential to ensure complete contact of the RECP with the soil. Soil Roughening is not recommended in areas where RECPs will be installed.
- Grade and shape the area of installation.
- Remove all rocks, clods, vegetation or other obstructions so that the installed blankets or mats will have complete, direct contact with the soil.
- Prepare seedbed by loosening 2 to 3 in. of topsoil.

Seeding/Planting

Seed the area before blanket installation for erosion control and re-vegetation. Seeding after mat installation is often specified for turf reinforcement application. When seeding prior to blanket installation, all areas disturbed during blanket installation must be re-seeded. Where soil filling is specified for turf reinforcement mats (TRMs), seed the matting and the entire disturbed area after installation and prior to filling the mat with soil.

Fertilize and seed in accordance with seeding specifications or other types of landscaping plans. The protective matting can be laid over areas where grass has been planted and the seedlings have emerged. Where vines or other ground covers are to be planted, lay the protective matting first and then plant through matting according to design of planting.

Check Slots

Check slots shall be installed as required by the manufacturer.

Laying and Securing Matting

- Before laying the matting, all check slots should be installed and the seedbed should be friable, made free from clods, rocks, and roots. The surface should be compacted and finished according to the requirements of the manufacturer's recommendations.
- Mechanical or manual lay down equipment should be capable of handling full rolls of fabric and laying the fabric smoothly without wrinkles or folds. The equipment should meet the fabric manufacturer's recommendations or equivalent standards.

Anchoring

- U-shaped wire staples, metal geotextile stake pins, or triangular wooden stakes can be used to anchor mats and blankets to the ground surface.
- Wire staples should be made of minimum 11 gauge steel wire and should be U-shaped with 8 in. legs and 2 in. crown.
- Metal stake pins should be 0.188 in. diameter steel with a 1.5 in. steel washer at the head of the pin, and 8 in. in length.
- Wire staples and metal stakes should be driven flush to the soil surface.

Installation on Slopes

Installation should be in accordance with the manufacturer's recommendations. In general, these will be as follows:

- Begin at the top of the slope and anchor the blanket in a 6 in. deep by 6 in. wide trench. Backfill trench and tamp earth firmly.
- Unroll blanket down slope in the direction of water flow.
- Overlap the edges of adjacent parallel rolls 2 to 3 in. and staple every 3 ft (or greater, per manufacturer's specifications).
- When blankets must be spliced, place blankets end over end (shingle style) with 6 in. overlap. Staple through overlapped area, approximately 12 in. apart.
- Lay blankets loosely and maintain direct contact with the soil. Do not stretch.
- Staple blankets sufficiently to anchor blanket and maintain contact with the soil. Staples should be placed down the center and staggered with the staples placed along the edges. Steep slopes, 1:1 (H:V) to 2:1 (H:V), require a minimum of 2 staples/yd². Moderate slopes, 2:1 (H:V) to 3:1 (H:V), require a minimum of 1 ½ staples/yd². Check manufacturer's specifications to determine if a higher density staple pattern is required.

Installation in Channels

Installation should be in accordance with the manufacturer's recommendations. In general, these will be as follows:

- Dig initial anchor trench 12 in. deep and 6 in. wide across the channel at the lower end of the project area.
- Excavate intermittent check slots, 6 in. deep and 6 in. wide across the channel at 25 to 30 ft intervals along the channels.
- Cut longitudinal channel anchor trenches 4 in. deep and 4 in. wide along each side of the installation to bury edges of matting, whenever possible extend matting 2 to 3 in. above the crest of the channel side slopes.
- Beginning at the downstream end and in the center of the channel, place the initial end of the first roll in the anchor trench and secure with fastening devices at 12 in. intervals. Note: matting will initially be upside down in anchor trench.
- In the same manner, position adjacent rolls in anchor trench, overlapping the preceding roll a minimum of 3 in.
- Secure these initial ends of mats with anchors at 12 in. intervals, backfill and compact soil.
- Unroll center strip of matting upstream. Stop at next check slot or terminal anchor trench. Unroll adjacent mats upstream in similar fashion, maintaining a 3 in. overlap.

- Fold and secure all rolls of matting snugly into all transverse check slots. Lay mat in the bottom of the slot then fold back against itself. Anchor through both layers of mat at 12 in. intervals, then backfill and compact soil. Continue rolling all mat widths upstream to the next check slot or terminal anchor trench.
- Alternate method for non-critical installations: Place two rows of anchors on 6 in. centers at 25 to 30 ft. intervals in lieu of excavated check slots.
- Staple shingled lap spliced ends a minimum of 12 in. apart on 12 in. intervals.
- Place edges of outside mats in previously excavated longitudinal slots; anchor using prescribed staple pattern, backfill, and compact soil.
- Anchor, fill, and compact upstream end of mat in a 12 in. by 6 in. terminal trench.
- Secure mat to ground surface using U-shaped wire staples, geotextile pins, or wooden stakes.
- Seed and fill turf reinforcement matting with soil, if specified.

Soil Filling (if specified for turf reinforcement mat (TRM))

Installation should be in accordance with the manufacturer's recommendations. Typical installation guidelines are as follows:

- After seeding, spread and lightly rake ½-¾ inches of fine topsoil into the TRM apertures to completely fill TRM thickness. Use backside of rake or other flat implement.
- Alternatively, if allowed by product specifications, spread topsoil using lightweight loader, backhoe, or other power equipment. Avoid sharp turns with equipment.
- Always consult the manufacturer's recommendations for installation.
- Do not drive tracked or heavy equipment over mat.
- Avoid any traffic over matting if loose or wet soil conditions exist.
- Use shovels, rakes, or brooms for fine grading and touch up.
- Smooth out soil filling just exposing top netting of mat.

Temporary Soil Stabilization Removal

- Temporary soil stabilization removed from the site of the work must be disposed of if necessary.

Costs

Installed costs can be relatively high compared to other BMPs. Approximate costs for installed materials are shown below:

Rolled Erosion Control Products		Installed Cost per Acre (2004) ¹	Estimated Cost per Acre (2009) ²
Biodegradable	Jute Mesh	\$6,000-\$7,000	\$6,600-\$7,700
	Curled Wood Fiber	\$8,000-\$10,500	\$8,800-\$11,050
	Straw	\$8,000-\$10,500	\$8,800-\$11,050
	Wood Fiber	\$8,000-\$10,500	\$8,800-\$11,050
	Coconut Fiber	\$13,000-\$14,000	\$14,300-\$15,400
	Coconut Fiber Mesh	\$30,000-\$33,000	\$33,000-\$36,300
	Straw Coconut Fiber	\$10,000-\$12,000	\$11,000-\$13,200
Non-Biodegradable	Plastic Netting	\$2,000-\$2,200	\$2,200-\$2,220
	Plastic Mesh	\$3,000-\$3,500	\$3,300-\$3,850
	Synthetic Fiber with Netting	\$34,000-\$40,000	\$37,400-\$44,000
	Bonded Synthetic Fibers	\$45,000-\$55,000	\$49,500-\$60,500
	Combination with Biodegradable	\$30,000-\$36,000	\$33,000-\$39,600

1. Source: Cost information received from individual product manufacturers solicited by Geosyntec Consultants (2004).
 2. 2009 costs reflect a 10% escalation over year 2004 costs. Escalation based on informal survey of industry trends. Note: Expected cost increase is offset by competitive economic conditions.

Inspection and Maintenance

- RECPs must be inspected in accordance with General Permit requirements for the associated project type and risk level. It is recommended that at a minimum, BMPs be inspected weekly, prior to forecasted rain events, daily during extended rain events, and after the conclusion of rain events.
- Areas where erosion is evident shall be repaired and BMPs reapplied as soon as possible. Care should be exercised to minimize the damage to protected areas while making repairs, as any area damaged will require reapplication of BMPs.
- If washout or breakage occurs, re-install the material after repairing the damage to the slope or channel.
- Make sure matting is uniformly in contact with the soil.
- Check that all the lap joints are secure.
- Check that staples are flush with the ground.

References

Erosion and Sediment Control Manual, Oregon Department of Environmental Quality, February 2005

Erosion Control Pilot Study Report, State of California Department of Transportation (Caltrans), June 2000.

Guides for Erosion and Sediment Controls in California, USDA Soils Conservation Service, January 1991.

National Management Measures to Control Nonpoint Source Pollution from Urban Areas, United States Environmental Protection Agency, 2002.

Stormwater Quality Handbooks Construction Site Best Management Practices (BMPs) Manual, State of California Department of Transportation (Caltrans), March 2003.

Guidance Document: Soil Stabilization for Temporary Slopes, State of California Department of Transportation (Caltrans), November 1999.

Stormwater Management of the Puget Sound Basin, Technical Manual, Publication #91-75, Washington State Department of Ecology, February 1992.

Water Quality Management Plan for The Lake Tahoe Region, Volume II, Handbook of Management Practices, Tahoe Regional Planning Agency, November 1988.

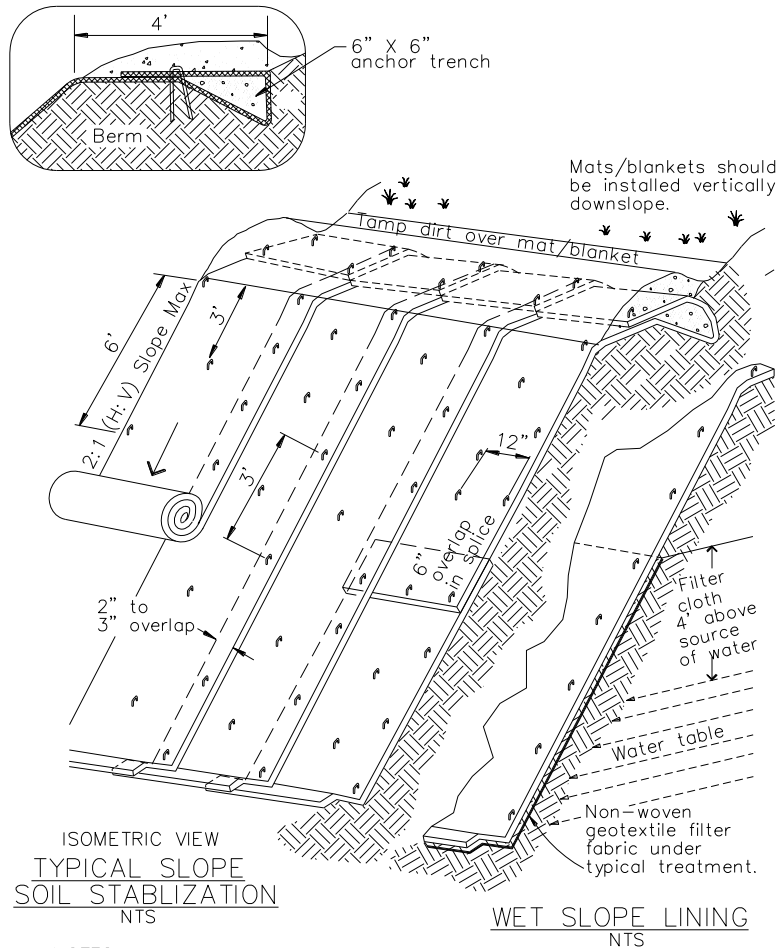

NOTES:

1. Slope surface shall be free of rocks, clods, sticks and grass. Mats/blankets shall have good soil contact.
2. Lay blankets loosely and stake or staple to maintain direct contact with the soil. Do not stretch.
3. Install per manufacturer's recommendations

TYPICAL INSTALLATION DETAIL

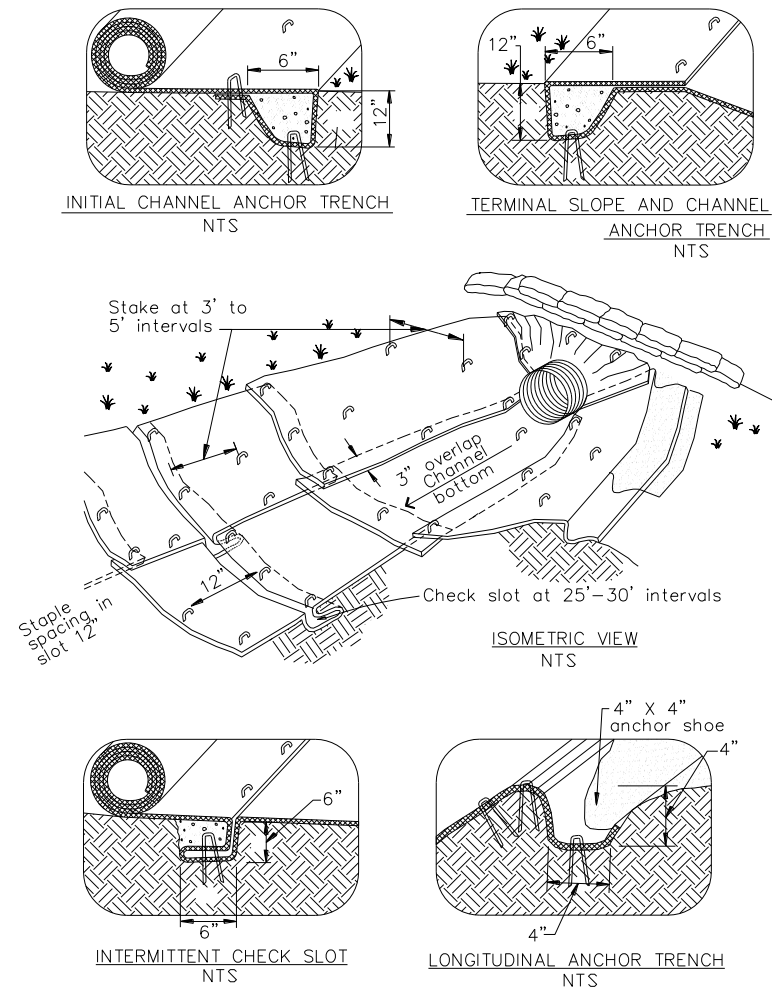

NOTES:

1. Check slots to be constructed per manufacturers specifications.
2. Staking or stapling layout per manufacturers specifications.
3. Install per manufacturer's recommendations

TYPICAL INSTALLATION DETAIL

Non-Vegetative Stabilization

EC-16



Description and Purpose

Non-vegetative stabilization methods are used for temporary or permanent stabilization of areas prone to erosion and should be used only where vegetative options are not feasible; examples include:

- Areas of vehicular or pedestrian traffic such as roads or paths;
- Arid environments where vegetation would not provide timely ground coverage, or would require excessive irrigation;
- Rocky substrate, infertile or droughty soils where vegetation would be difficult to establish; and
- Areas where vegetation will not grow adequately within the construction time frame.

There are several non-vegetative stabilization methods and selection should be based on site-specific conditions.

Decomposed Granite (DG) is a permanent erosion protection method that consists of a layer of stabilized decomposed granite placed over an erodible surface.

Degradable Mulches of various types (see EC-3, EC-6, EC-8) can be used for temporary non-vegetative stabilization; examples include straw mulch, compost, wood chips or hydraulic mulch.

Geotextiles and Mats can be used for temporary non-vegetative stabilization (see EC-7). These BMPs are typically manufactured from degradable or synthetic materials and are

Categories

EC	Erosion Control	<input checked="" type="checkbox"/>
SE	Sediment Control	<input checked="" type="checkbox"/>
TR	Tracking Control	
WE	Wind Erosion Control	<input checked="" type="checkbox"/>
NS	Non-Stormwater Management Control	
WM	Waste Management and Materials Pollution Control	

Legend:

- Primary Category
- Secondary Category

Targeted Constituents

Sediment	<input checked="" type="checkbox"/>
Nutrients	
Trash	
Metals	
Bacteria	
Oil and Grease	
Organics	

Potential Alternatives

None

If User/Subscriber modifies this fact sheet in any way, the CASQA name/logo and footer below must be removed from each page and not appear on the modified version.



Non-Vegetative Stabilization

EC-16

designed and specified based on their functional longevity, i.e., how long they will persist and provide erosion protection. All geotextiles and mats should be replaced when they exceed their functional longevity or when permanent stabilization methods are instituted.

Gravel Mulch is a non-degradable erosion control product that is composed of washed and screened coarse to very coarse gravel, 16 mm to 64 mm (0.6" - 2.5"), similar to an AASHTO No. 3 coarse aggregate.

Rock Slope Protection consists of utilizing large rock or rip-rap (4" - 24") to stabilize slopes with a high erosion potential and those subject to scour along waterways.

Soil Binders can be used for temporary non-vegetative stabilization (see EC-5). The key to their use is functional longevity. In most cases, the soil binder will need to be routinely monitored and re-applied to maintain an erosion-resistant coverage.

Suitable Applications

Non-vegetated stabilization methods are suitable for use on disturbed soil areas and on material stockpiles that need to be temporarily or permanently protected from erosion by water and wind. Non-vegetated stabilization should only be utilized when vegetation cannot be established in the required timeframe, due to soil or climactic conditions, or where vegetation may be a potential fire hazard.

Decomposed Granite (DG) and Gravel Mulch are suitable for use in areas where vegetation establishment is difficult, on flat surfaces, trails and pathways, and when used in conjunction with a stabilizer or tackifier, on shallow slopes (i.e., 10:1 [H:V]). DG and gravel can also be used on shallow rocky slopes where vegetation cannot be established for permanent erosion control.

Degradable Mulches can be used to cover and protect soil surfaces from erosion both in temporary and permanent applications. In many cases, the use of mulches by themselves requires routine inspection and re-application. See EC-3 Hydraulic Mulch, EC-6 Straw Mulch, EC-8 Wood Mulch, or EC-14 Compost Blankets for more information.

Geotextiles and Mats can be used as a temporary stand-alone soil stabilization method. Depending on material selection, geotextiles and mats can be a short-term (3 mos – 1 year) or long-term (1-2 years) temporary stabilization method. For more information on geotextiles and mats see EC-7 Geotextiles and Mats.

Rock Slope Protection can be used when the slopes are subject to scour or have a high erosion potential, such as slopes adjacent to flowing waterways or slopes subject to overflow from detention facilities (spillways).

Soil Binders can be used for temporary stabilization of stockpiles and disturbed areas not subject to heavy traffic. See EC-5 Soil Binders for more information.

Limitations

General

- Refer to EC-3, EC-6, EC-8, and EC-14 for limitations on use of mulches. Refer to EC-7 for limitations on use of geotextiles and mats. Refer to EC-5 for limitations on use of Soil Binders.

Decomposed Granite

- Not available in some geographic regions.
- If not tackified, material may be susceptible to erosion even on slight slopes (e.g., 30:1 [H:V]).
- Installed costs may be more expensive than vegetative stabilization methods.

Gravel Mulch

- Availability is limited in some geographic regions.
- If not properly screened and washed, can contain fine material that can erode and/or create dust problems.
- If inadequately sized, material may be susceptible to erosion on sloped areas.
- Pore spaces fill with dirt and debris over time; may provide a growing medium for weeds.

Rock Slope Protection

- Installation is labor intensive.
- Installed costs can be significantly higher than vegetative stabilization methods.
- Rounded stones may not be used on slopes greater than 2:1 [H:V].

Implementation

General

Non-vegetated stabilization should be used in accordance with the following general guidance:

- Should be used in conjunction with other BMPs, including drainage, erosion controls and sediment controls.
- Refer to EC-3, EC-6, EC-8, and EC-14 for implementation details for mulches. Refer to EC-7 for implementation details for geotextiles and mats. Refer to EC-5 for implementation details for soil binders.
- Non-vegetated stabilization measures should be implemented as soon as the disturbance in the areas they are intended to protect has ceased.
- Additional guidance on the comparison and selection of temporary slope stabilization methods is provided in Appendix F of the Handbook.

Decomposed Granite Stabilization

- If used for a road or path should be installed on a prepared base.
- Should be mixed with a stabilizer if used for roads or pathways, or on slope applications.
- Though porous it is recommended to prevent standing water on or next to a decomposed granite road or pathway.

Gravel Mulch

- Should be sized based on slope, rainfall, and upgradient run-on conditions. Stone size should be increased as potential for erosion increases (steeper slopes, high intensity rainfall).
- If permanent, a weed control fabric should be placed prior to installation.
- Should be installed at a minimum 2" depth.
- Should completely cover all exposed surfaces.

Rock Slope Protection

- Rock slope protection installation should follow Caltrans Standard Specification 72-2: Rock Slope Protection. Refer to the specification for rock conformity requirements and installation methods.
- When using rock slope protection, rock size and installation method should be specified by an Engineer.
- A geotextile fabric should be placed prior to installation.

Costs

- Costs are highly variable depending not only on technique chosen, but also on materials chosen within specific techniques. In addition, availability of certain materials will vary by region/location, which will also affect the cost. Costs of mulches, geotextiles and mats, and soil binders are presented in their respective fact sheets. Costs for decomposed granite, gravel mulch stabilization and rock slope protection may be higher depending on location and availability of materials. Caltrans has provided an estimate for gravel mulch of \$10 - \$15/yd² in flat areas and \$11 - \$23/yd² on side slopes.

Inspection and Maintenance

General

- BMPs must be inspected in accordance with General Permit requirements for the associated project type and risk level. It is recommended that at a minimum, BMPs be inspected weekly, prior to forecasted rain events, daily during extended rain events, and after the conclusion of rain events.
- For permanent installation, require inspection periodically and after major storm events to look for signs of erosion or damage to the stabilization.
- All damage should be repaired immediately.
- Refer to EC-3, EC-6, EC-8, and EC-14 for inspection and maintenance requirements for mulches. Refer to EC-7 for inspection and maintenance requirements for geotextiles and mats. Refer to EC-5 for inspection and maintenance requirements for soil binders.

Decomposed Granite and Gravel Mulch Stabilization

- Rake out and add decomposed granite or gravel as needed to areas subject to rill erosion. Inspect upgradient drainage controls and repair/modify as necessary.

Non-Vegetative Stabilization

EC-16

- Should remain stable under loose surface material. Any significant problem areas should be repaired to restore uniformity to the installation.

References

Arid Zone Forestry: A Guide for Field Technicians. Food and Agriculture Organization of the United Nations, 1989.

Design of Roadside Channels with Flexible Linings, Hydraulic Engineering Circular Number 15, Third Edition, Federal Highway Administration, 2007.

Design Standards for Urban Infrastructure - Soft Landscape Design, Department of Territory and Municipal Services - Australian Capital Territory http://www.tams.act.gov.au/work/standards_and_procedures/design_standards_for_urban_infrastructure

Erosion and Sediment Control Handbook: A Guide for Protection of State Waters through the use of Best Management Practices during Land Disturbing Activities, Tennessee Department of Environment and Conservation, 2002.

Gravel Mulch, Landscape Architecture Non-Standard Specification 10-2, California Department of Transportation (Caltrans), <http://www.dot.ca.gov/hq/LandArch/roadside/detail-gm.htm>

Maine Erosion and Sediment Control BMPs, DEPLW0588, Maine Department of Environmental Protection: Bureau of Land and Water Quality, 2003.

National Menu of Best Management Practices, US Environmental Protection Agency, 2006.

Standard Specification 72-2: Rock Slope Protection. California Department of Transportation, 2006.

Stormwater Quality Handbooks Construction Site Best Management Practices (BMPs) Manual, State of California Department of Transportation (Caltrans), March 2003.

Silt Fence

SE-1

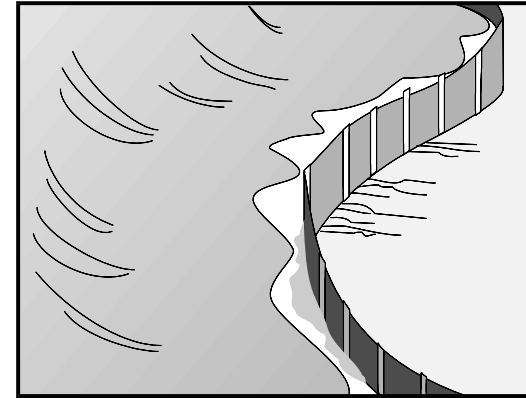

Description and Purpose

A silt fence is made of a woven geotextile that has been entrenched, attached to supporting poles, and sometimes backed by a plastic or wire mesh for support. The silt fence detains water, promoting sedimentation of coarse sediment behind the fence. Silt fence does not retain soil fine particles like clays or silts.

Suitable Applications

Silt fences are suitable for perimeter control, placed below areas where sheet flows discharge from the site. They could also be used as interior controls below disturbed areas where runoff may occur in the form of sheet and rill erosion and around inlets within disturbed areas (SE-10). Silt fences should not be used in locations where the flow is concentrated. Silt fences should always be used in combination with erosion controls. Suitable applications include:

- At perimeter of a project.
- Below the toe or down slope of exposed and erodible slopes.
- Along streams and channels.
- Around temporary spoil areas and stockpiles.
- Around inlets.
- Below other small cleared areas.

Categories

EC	Erosion Control	
SE	Sediment Control	<input checked="" type="checkbox"/>
TC	Tracking Control	
WE	Wind Erosion Control	
NS	Non-Stormwater Management Control	
WM	Waste Management and Materials Pollution Control	

Legend:

- Primary Category
- Secondary Category

Targeted Constituents

Sediment (coarse sediment)	<input checked="" type="checkbox"/>
Nutrients	
Trash	
Metals	
Bacteria	
Oil and Grease	
Organics	

Potential Alternatives

- SE-5 Fiber Rolls
- SE-6 Gravel Bag Berm
- SE-12 Manufactured Linear Sediment Controls
- SE-13 Compost Socks and Berms
- SE-14 Biofilter Bags

If User/Subscriber modifies this fact sheet in any way, the CASQA name/logo and footer below must be removed from each page and not appear on the modified version.



Limitations

- Do not use in streams, channels, drain inlets, or anywhere flow is concentrated.
- Do not use in locations where ponded water may cause a flooding hazard.
- Do not use silt fence to divert water flows or place across any contour line.
- Improperly installed fences are subject to failure from undercutting, overtopping, or collapsing.
- Must be trenched and keyed in.
- Not intended for use as a substitute for Fiber Rolls (SE-5), when fiber rolls are being used as a slope interruption device.
- Do not use on slopes subject to creeping, slumping, or landslides.

Implementation

General

A silt fence is a temporary sediment barrier consisting of woven geotextile stretched across and attached to supporting posts, trenched-in, and, depending upon the strength of fabric used, supported with plastic or wire mesh fence. Silt fences trap coarse sediment by intercepting and detaining sediment-laden runoff from disturbed areas in order to promote sedimentation behind the fence.

The following layout and installation guidance can improve performance and should be followed:

- Silt fence should be used in combination with erosion controls up-slope in order to provide the most effective sediment control.
- Silt fence alone is not effective at reducing turbidity. (Barrett and Malina, 2004)
- Designers should consider diverting sediment laden water to a temporary sediment basin or trap. (EPA, 2012)
- Use principally in areas where sheet flow occurs.
- Install along a level contour, so water does not pond more than 1.5 ft at any point along the silt fence.
- Provide sufficient room for runoff to pond behind the fence and to allow sediment removal equipment to pass between the silt fence and toes of slopes or other obstructions. About 1200 ft² of ponding area should be provided for every acre draining to the fence.
- Efficiency of silt fences is primarily dependent on the detention time of the runoff behind the control. (Barrett and Malina, 2004)
- The drainage area above any fence should not exceed a quarter of an acre. (Rule of Thumb-100-foot of silt fence per 10,000 square feet of disturbed area.) (EPA 2012)

- The maximum length of slope draining to any point along the silt fence should be 100 ft per foot of silt fence.
- Turn the ends of the filter fence uphill to prevent stormwater from flowing around the fence.
- Leave an undisturbed or stabilized area immediately down slope from the fence where feasible.
- Silt fences should remain in place until the disturbed area draining to the silt fence is permanently stabilized, after which, the silt fence fabric and posts should be removed and properly disposed.
- J-Hooks, which have ends turning up the slope to break up long runs of fence and provide multiple storage areas that work like mini-retention areas, may be used to increase the effectiveness of silt fence.
- Be aware of local regulations regarding the type and installation requirements of silt fence, which may differ from those presented in this fact sheet.

Design and Layout

In areas where high winds are anticipated the fence should be supported by a plastic or wire mesh. The geotextile fabric of the silt fence should contain ultraviolet inhibitors and stabilizers to provide longevity equivalent to the project life or replacement schedule.

- Layout in accordance with the attached figures.
- For slopes that contain a high number of rocks or large dirt clods that tend to dislodge, it may be necessary to protect silt fence from rocks (e.g., rockfall netting) ensure the integrity of the silt fence installation.

Standard vs. Heavy Duty Silt Fence

Standard Silt Fence

- Generally applicable in cases where the area draining to fence produces moderate sediment loads.

Heavy Duty Silt Fence

- Heavy duty silt fence usually has 1 or more of the following characteristics, not possessed by standard silt fence.
 - Fabric is reinforced with wire backing or additional support.
 - Posts are spaced closer than pre-manufactured, standard silt fence products.
- Use is generally limited to areas affected by high winds.
- Area draining to fence produces moderate sediment loads.

Materials

Standard Silt Fence

- Silt fence material should be woven geotextile with a minimum width of 36 in. The fabric should conform to the requirements in ASTM designation D6461.
- Wooden stakes should be commercial quality lumber of the size and shape shown on the plans. Each stake should be free from decay, splits or cracks longer than the

thickness of the stake or other defects that would weaken the stakes and cause the stakes to be structurally unsuitable.

- Staples used to fasten the fence fabric to the stakes should be not less than 1.75 in. long and should be fabricated from 15 gauge or heavier wire. The wire used to fasten the tops of the stakes together when joining two sections of fence should be 9 gauge or heavier wire. Galvanizing of the fastening wire will not be required.

Heavy-Duty Silt Fence

- Some silt fence has a wire backing to provide additional support, and there are products that may use prefabricated plastic holders for the silt fence and use metal posts instead of wood stakes.

Installation Guidelines – Traditional Method

Silt fences are to be constructed on a level contour. Sufficient area should exist behind the fence for ponding to occur without flooding or overtopping the fence.

- A trench should be excavated approximately 6 in. wide and 6 in. deep along the line of the proposed silt fence (trenches should not be excavated wider or deeper than necessary for proper silt fence installation).
- Bottom of the silt fence should be keyed-in a minimum of 12 in.
- Posts should be spaced a maximum of 6 ft apart and driven securely into the ground a minimum of 18 in. or 12 in. below the bottom of the trench.
- When standard strength geotextile is used, a plastic or wire mesh support fence should be fastened securely to the upslope side of posts using heavy-duty wire staples at least 1 in. long. The mesh should extend into the trench.
- When extra-strength geotextile and closer post spacing are used, the mesh support fence may be eliminated.
- Woven geotextile should be purchased in a long roll, then cut to the length of the barrier. When joints are necessary, geotextile should be spliced together only at a support post, with a minimum 6 in. overlap and both ends securely fastened to the post.
- The trench should be backfilled with native material and compacted.
- Construct the length of each reach so that the change in base elevation along the reach does not exceed 1/3 the height of the barrier; in no case should the reach exceed 500 ft.
- Cross barriers should be a minimum of 1/3 and a maximum of 1/2 the height of the linear barrier.
- See typical installation details at the end of this fact sheet.

Installation Guidelines - Static Slicing Method

- Static Slicing is defined as insertion of a narrow blade pulled behind a tractor, similar to a plow blade, at least 10 inches into the soil while at the same time pulling silt geotextile fabric into the ground through the opening created by the blade to the depth of the blade. Once the geotextile is installed, the soil is compacted using tractor tires.
- This method will not work with pre-fabricated, wire backed silt fence.
- Benefits:
 - Ease of installation (most often done with a 2 person crew).
 - Minimal soil disturbance.
 - Better level of compaction along fence, less susceptible to undercutting
 - Uniform installation.
- Limitations:
 - Does not work in shallow or rocky soils.
 - Complete removal of geotextile material after use is difficult.
 - Be cautious when digging near potential underground utilities.

Costs

- It should be noted that costs vary greatly across regions due to available supplies and labor costs.
- Average annual cost for installation using the traditional silt fence installation method (assumes 6 month useful life) is \$7 per linear foot based on vendor research. Range of cost is \$3.50 - \$9.10 per linear foot.

Inspection and Maintenance

- BMPs must be inspected in accordance with General Permit requirements for the associated project type and risk level. It is recommended that at a minimum, BMPs be inspected weekly, prior to forecasted rain events, daily during extended rain events, and after the conclusion of rain events.
- Repair undercut silt fences.
- Repair or replace split, torn, slumping, or weathered fabric. The lifespan of silt fence fabric is generally 5 to 8 months.
- Silt fences that are damaged and become unsuitable for the intended purpose should be removed from the site of work, disposed, and replaced with new silt fence barriers.
- Sediment that accumulates in the BMP should be periodically removed in order to maintain BMP effectiveness. Sediment should be removed when the sediment accumulation reaches 1/3 of the barrier height.
- Silt fences should be left in place until the upgradient area is permanently stabilized. Until then, the silt fence should be inspected and maintained regularly.

Silt Fence

SE-1

- Remove silt fence when upgradient areas are stabilized. Fill and compact post holes and anchor trench, remove sediment accumulation, grade fence alignment to blend with adjacent ground, and stabilize disturbed area.

References

Manual of Standards of Erosion and Sediment Control Measures, Association of Bay Area Governments, May 1995.

Monitoring Data on Effectiveness of Sediment Control Techniques, Proceedings of World Water and Environmental Resources Congress, Barrett M. and Malina J. 2004.

National Management Measures to Control Nonpoint Source Pollution from Urban Areas, United States Environmental Protection Agency, 2002.

Proposed Guidance Specifying Management Measures for Sources of Nonpoint Pollution in Coastal Waters, Work Group-Working Paper, USEPA, April 1992.

Sedimentation and Erosion Control Practices, and Inventory of Current Practices (Draft), USEPA, 1990.

Southeastern Wisconsin Regional Planning Commission (SWRPC). Costs of Urban Nonpoint Source Water Pollution Control Measures. Technical Report No. 31. Southeastern Wisconsin Regional Planning Commission, Waukesha, WI. 1991.

Stormwater Quality Handbooks - Construction Site Best Management Practices (BMPs) Manual, State of California Department of Transportation (Caltrans), March 2003.

Stormwater Management Manual for The Puget Sound Basin, Washington State Department of Ecology, Public Review Draft, 1991.

U.S. Environmental Protection Agency (USEPA). Stormwater Best Management Practices: Silt Fences. U.S. Environmental Protection Agency, Office of Water, Washington, DC, 2012.

U.S. Environmental Protection Agency (USEPA). Stormwater Management for Industrial Activities: Developing Pollution Prevention Plans and Best Management Practices. U.S. Environmental Protection Agency, Office of Water, Washington, DC, 1992.

Water Quality Management Plan for the Lake Tahoe Region, Volume II, Handbook of Management Practices, Tahoe Regional Planning Agency, November 1988.

Soil Stabilization BMP Research for Erosion and Sediment Controls: Cost Survey Technical Memorandum, State of California Department of Transportation (Caltrans), July 2007.

Erosion and Sediment Control Manual, Oregon Department of Environmental Quality, February 2005.

Silt Fence

SE-1

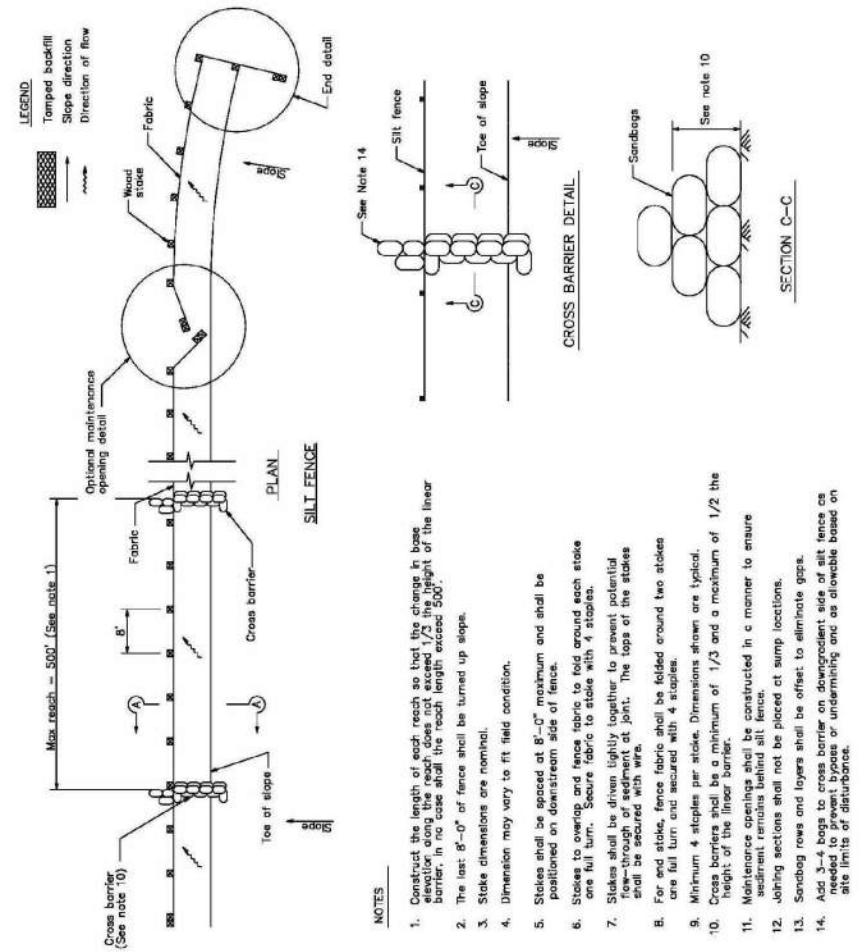

Silt Fence

SE-1

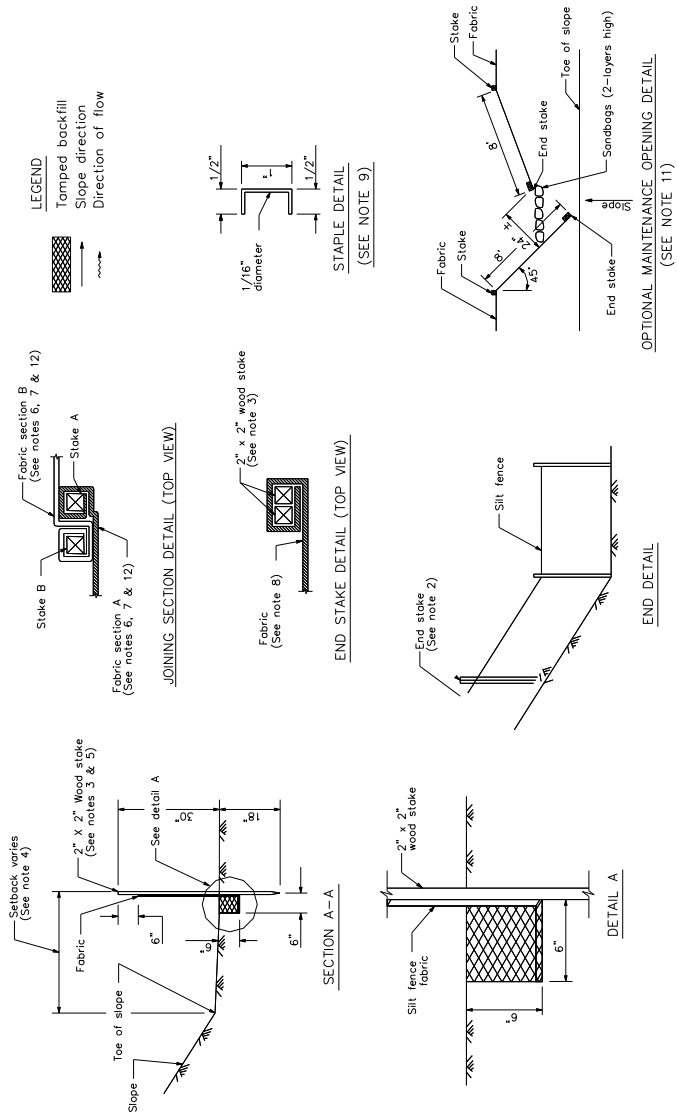

Silt Fence

SE-1

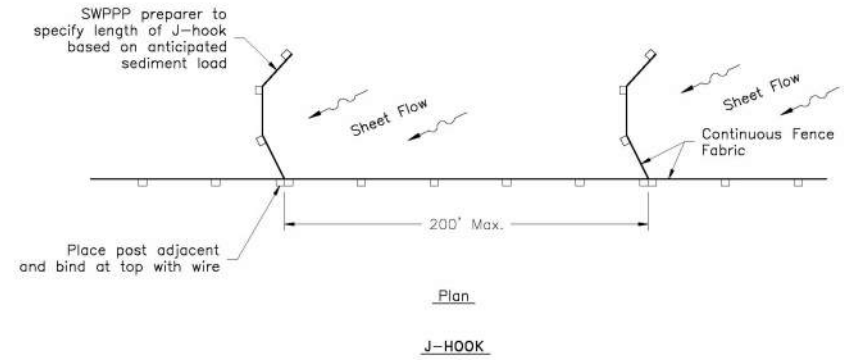

Gravel Bag Berm

SE-6

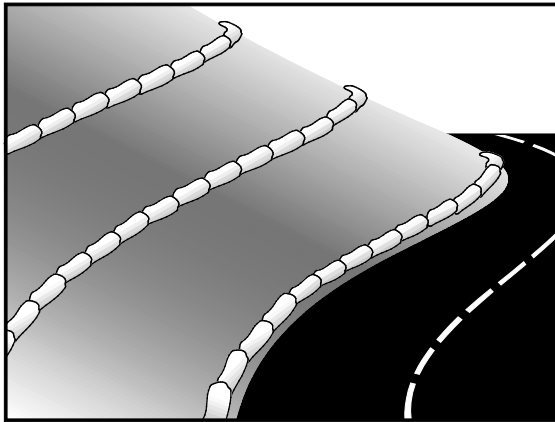

Description and Purpose

A gravel bag berm is a series of gravel-filled bags placed on a level contour to intercept sheet flows. Gravel bags pond sheet flow runoff, allowing sediment to settle out, and release runoff slowly as sheet flow, preventing erosion.

Suitable Applications

Gravel bag berms may be suitable:

- As a linear sediment control measure:
 - Below the toe of slopes and erodible slopes
 - As sediment traps at culvert/pipe outlets
 - Below other small cleared areas
 - Along the perimeter of a site
 - Down slope of exposed soil areas
 - Around temporary stockpiles and spoil areas
 - Parallel to a roadway to keep sediment off paved areas
 - Along streams and channels
- As a linear erosion control measure:
 - Along the face and at grade breaks of exposed and erodible slopes to shorten slope length and spread runoff as sheet flow.

Categories

EC	Erosion Control	<input checked="" type="checkbox"/>
SE	Sediment Control	<input checked="" type="checkbox"/>
TC	Tracking Control	
WE	Wind Erosion Control	
NS	Non-Stormwater Management Control	
WM	Waste Management and Materials Pollution Control	

Legend:

- Primary Category
- Secondary Category

Targeted Constituents

Sediment	<input checked="" type="checkbox"/>
Nutrients	
Trash	
Metals	
Bacteria	
Oil and Grease	
Organics	

Potential Alternatives

- SE-1 Silt Fence
- SE-5 Fiber Roll
- SE-8 Sandbag Barrier
- SE-12 Temporary Silt Dike
- SE-14 Biofilter Bags

If User/Subscriber modifies this fact sheet in any way, the CASQA name/logo and footer below must be removed from each page and not appear on the modified version.



Gravel Bag Berm

SE-6

- At the top of slopes to divert runoff away from disturbed slopes.
- As chevrons (small check dams) across mildly sloped construction roads. For use check dam use in channels, see SE-4, Check Dams.

Limitations

- Gravel berms may be difficult to remove.
- Removal problems limit their usefulness in landscaped areas.
- Gravel bag berm may not be appropriate for drainage areas greater than 5 acres.
- Runoff will pond upstream of the berm, possibly causing flooding if sufficient space does not exist.
- Degraded gravel bags may rupture when removed, spilling contents.
- Installation can be labor intensive.
- Durability of gravel bags is somewhat limited and bags may need to be replaced when installation is required for longer than 6 months.
- Easily damaged by construction equipment.
- When used to detain concentrated flows, maintenance requirements increase.

Implementation

General

A gravel bag berm consists of a row of open graded gravel-filled bags placed on a level contour. When appropriately placed, a gravel bag berm intercepts and slows sheet flow runoff, causing temporary ponding. The temporary ponding allows sediment to settle. The open graded gravel in the bags is porous, which allows the ponded runoff to flow slowly through the bags, releasing the runoff as sheet flows. Gravel bag berms also interrupt the slope length and thereby reduce erosion by reducing the tendency of sheet flows to concentrate into rivulets, which erode rills, and ultimately gullies, into disturbed, sloped soils. Gravel bag berms are similar to sand bag barriers, but are more porous. Generally, gravel bag berms should be used in conjunction with temporary soil stabilization controls up slope to provide effective erosion and sediment control.

Design and Layout

- Locate gravel bag berms on level contours.
- When used for slope interruption, the following slope/sheet flow length combinations apply:
 - Slope inclination of 4:1 (H:V) or flatter: Gravel bags should be placed at a maximum interval of 20 ft, with the first row near the slope toe.
 - Slope inclination between 4:1 and 2:1 (H:V): Gravel bags should be placed at a maximum interval of 15 ft. (a closer spacing is more effective), with the first row near the slope toe.

Slope inclination 2:1 (H:V) or greater: Gravel bags should be placed at a maximum interval of 10 ft. (a closer spacing is more effective), with the first row near the slope toe.

- Turn the ends of the gravel bag barriers up slope to prevent runoff from going around the berm.
- Allow sufficient space up slope from the gravel bag berm to allow ponding, and to provide room for sediment storage.
- For installation near the toe of the slope, gravel bag barriers should be set back from the slope toe to facilitate cleaning. Where specific site conditions do not allow for a set-back, the gravel bag barrier may be constructed on the toe of the slope. To prevent flows behind the barrier, bags can be placed perpendicular to a berm to serve as cross barriers.
- Drainage area should not exceed 5 acres.
- In Non-Traffic Areas:
 - Height = 18 in. maximum
 - Top width = 24 in. minimum for three or more layer construction
 - Top width = 12 in. minimum for one or two layer construction
 - Side slopes = 2:1 (H:V) or flatter
- In Construction Traffic Areas:
 - Height = 12 in. maximum
 - Top width = 24 in. minimum for three or more layer construction.
 - Top width = 12 in. minimum for one or two layer construction.
 - Side slopes = 2:1 (H:V) or flatter.
- Butt ends of bags tightly.
- On multiple row, or multiple layer construction, overlap butt joints of adjacent row and row beneath.
- Use a pyramid approach when stacking bags.

Materials

- **Bag Material:** Bags should be woven polypropylene, polyethylene or polyamide fabric or burlap, minimum unit weight of 4 ounces/yd², Mullen burst strength exceeding 300 lb/in² in conformance with the requirements in ASTM designation D3786, and ultraviolet stability exceeding 70% in conformance with the requirements in ASTM designation D4355.

- **Bag Size:** Each gravel-filled bag should have a length of 18 in., width of 12 in., thickness of 3 in., and mass of approximately 33 lbs. Bag dimensions are nominal, and may vary based on locally available materials.
- **Fill Material:** Fill material should be 0.5 to 1 in. crushed rock, clean and free from clay, organic matter, and other deleterious material, or other suitable open graded, non-cohesive, porous gravel.

Costs

Material costs for gravel bags are average and are dependent upon material availability. \$2.50-3.00 per filled gravel bag is standard based upon vendor research.

Inspection and Maintenance

- BMPs must be inspected in accordance with General Permit requirements for the associated project type and risk level. It is recommended that at a minimum, BMPs be inspected weekly, prior to forecasted rain events, daily during extended rain events, and after the conclusion of rain events.
- Gravel bags exposed to sunlight will need to be replaced every two to three months due to degrading of the bags.
- Reshape or replace gravel bags as needed.
- Repair washouts or other damage as needed.
- Sediment that accumulates in the BMP should be periodically removed in order to maintain BMP effectiveness. Sediment should be removed when the sediment accumulation reaches one-third of the barrier height.
- Remove gravel bag berms when no longer needed and recycle gravel fill whenever possible and properly dispose of bag material. Remove sediment accumulation and clean, re-grade, and stabilize the area.

References

Handbook of Steel Drainage and Highway Construction, American Iron and Steel Institute, 1983.

Stormwater Quality Handbooks - Construction Site Best Management Practices (BMPs) Manual, State of California Department of Transportation (Caltrans), March 2003.

Stormwater Pollution Plan Handbook, First Edition, State of California, Department of Transportation Division of New Technology, Materials and Research, October 1992.

Erosion and Sediment Control Manual, Oregon Department of Environmental Quality, February 2005.

Street Sweeping and Vacuuming SE-7



Description and Purpose

Street sweeping and vacuuming includes use of self-propelled and walk-behind equipment to remove sediment from streets and roadways, and to clean paved surfaces in preparation for final paving. Sweeping and vacuuming prevents sediment from the project site from entering storm drains or receiving waters.

Suitable Applications

Sweeping and vacuuming are suitable anywhere sediment is tracked from the project site onto public or private paved streets and roads, typically at points of egress. Sweeping and vacuuming are also applicable during preparation of paved surfaces for final paving.

Limitations

Sweeping and vacuuming may not be effective when sediment is wet or when tracked soil is caked (caked soil may need to be scraped loose).

Implementation

- Controlling the number of points where vehicles can leave the site will allow sweeping and vacuuming efforts to be focused, and perhaps save money.
- Inspect potential sediment tracking locations daily.
- Visible sediment tracking should be swept or vacuumed on a daily basis.

Categories

EC	Erosion Control	
SE	Sediment Control	<input checked="" type="checkbox"/>
TC	Tracking Control	<input checked="" type="checkbox"/>
WE	Wind Erosion Control	
NS	Non-Stormwater Management Control	
WM	Waste Management and Materials Pollution Control	

Legend:

- Primary Objective
- Secondary Objective

Targeted Constituents

Sediment	<input checked="" type="checkbox"/>
Nutrients	
Trash	<input checked="" type="checkbox"/>
Metals	
Bacteria	
Oil and Grease	<input checked="" type="checkbox"/>
Organics	

Potential Alternatives

None

If User/Subscriber modifies this fact sheet in any way, the CASQA name/logo and footer below must be removed from each page and not appear on the modified version.



Street Sweeping and Vacuuming SE-7

- Do not use kick brooms or sweeper attachments. These tend to spread the dirt rather than remove it.
- If not mixed with debris or trash, consider incorporating the removed sediment back into the project

Costs

Rental rates for self-propelled sweepers vary depending on hopper size and duration of rental. Expect rental rates from \$58/hour (3 yd³ hopper) to \$88/hour (9 yd³ hopper), plus operator costs. Hourly production rates vary with the amount of area to be swept and amount of sediment. Match the hopper size to the area and expect sediment load to minimize time spent dumping.

Inspection and Maintenance

- Inspect BMPs in accordance with General Permit requirements for the associated project type and risk level. It is recommended that at a minimum, BMPs be inspected weekly, prior to forecasted rain events, daily during extended rain events, and after the conclusion of rain events.
- When actively in use, points of ingress and egress must be inspected daily.
- When tracked or spilled sediment is observed outside the construction limits, it must be removed at least daily. More frequent removal, even continuous removal, may be required in some jurisdictions.
- Be careful not to sweep up any unknown substance or any object that may be potentially hazardous.
- Adjust brooms frequently; maximize efficiency of sweeping operations.
- After sweeping is finished, properly dispose of sweeper wastes at an approved dumpsite.

References

Stormwater Quality Handbooks - Construction Site Best Management Practices (BMPs) Manual, State of California Department of Transportation (Caltrans), November 2000.

Labor Surcharge and Equipment Rental Rates, State of California Department of Transportation (Caltrans), April 1, 2002 – March 31, 2003.

Stabilized Construction Entrance/Exit TC-1

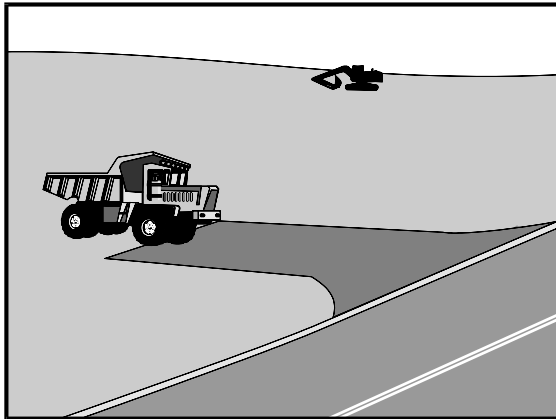

Description and Purpose

A stabilized construction access is defined by a point of entrance/exit to a construction site that is stabilized to reduce the tracking of mud and dirt onto public roads by construction vehicles.

Suitable Applications

Use at construction sites:

- Where dirt or mud can be tracked onto public roads.
- Adjacent to water bodies.
- Where poor soils are encountered.
- Where dust is a problem during dry weather conditions.

Limitations

- Entrances and exits require periodic top dressing with additional stones.
- This BMP should be used in conjunction with street sweeping on adjacent public right of way.
- Entrances and exits should be constructed on level ground only.
- Stabilized construction entrances are rather expensive to construct and when a wash rack is included, a sediment trap of some kind must also be provided to collect wash water runoff.

Categories

EC	Erosion Control	<input checked="" type="checkbox"/>
SE	Sediment Control	<input checked="" type="checkbox"/>
TC	Tracking Control	<input checked="" type="checkbox"/>
WE	Wind Erosion Control	
NS	Non-Stormwater Management Control	
WM	Waste Management and Materials Pollution Control	

Legend:

- Primary Objective
- Secondary Objective

Targeted Constituents

Sediment	<input checked="" type="checkbox"/>
Nutrients	
Trash	
Metals	
Bacteria	
Oil and Grease	
Organics	

Potential Alternatives

None

If User/Subscriber modifies this fact sheet in any way, the CASQA name/logo and footer below must be removed from each page and not appear on the modified version.



Stabilized Construction Entrance/Exit TC-1

Implementation

General

A stabilized construction entrance is a pad of aggregate underlain with filter cloth located at any point where traffic will be entering or leaving a construction site to or from a public right of way, street, alley, sidewalk, or parking area. The purpose of a stabilized construction entrance is to reduce or eliminate the tracking of sediment onto public rights of way or streets. Reducing tracking of sediments and other pollutants onto paved roads helps prevent deposition of sediments into local storm drains and production of airborne dust.

Where traffic will be entering or leaving the construction site, a stabilized construction entrance should be used. NPDES permits require that appropriate measures be implemented to prevent tracking of sediments onto paved roadways, where a significant source of sediments is derived from mud and dirt carried out from unpaved roads and construction sites.

Stabilized construction entrances are moderately effective in removing sediment from equipment leaving a construction site. The entrance should be built on level ground. Advantages of the Stabilized Construction Entrance/Exit is that it does remove some sediment from equipment and serves to channel construction traffic in and out of the site at specified locations. Efficiency is greatly increased when a washing rack is included as part of a stabilized construction entrance/exit.

Design and Layout

- Construct on level ground where possible.
- Select 3 to 6 in. diameter stones.
- Use minimum depth of stones of 12 in. or as recommended by soils engineer.
- Construct length of 50 ft or maximum site will allow, and 10 ft minimum width or to accommodate traffic.
- Rumble racks constructed of steel panels with ridges and installed in the stabilized entrance/exit will help remove additional sediment and to keep adjacent streets clean.
- Provide ample turning radii as part of the entrance.
- Limit the points of entrance/exit to the construction site.
- Limit speed of vehicles to control dust.
- Properly grade each construction entrance/exit to prevent runoff from leaving the construction site.
- Route runoff from stabilized entrances/exits through a sediment trapping device before discharge.
- Design stabilized entrance/exit to support heaviest vehicles and equipment that will use it.

Stabilized Construction Entrance/Exit TC-1

- Select construction access stabilization (aggregate, asphaltic concrete, concrete) based on longevity, required performance, and site conditions. Do not use asphalt concrete (AC) grindings for stabilized construction access/roadway.
- If aggregate is selected, place crushed aggregate over geotextile fabric to at least 12 in. depth, or place aggregate to a depth recommended by a geotechnical engineer. A crushed aggregate greater than 3 in. but smaller than 6 in. should be used.
- Designate combination or single purpose entrances and exits to the construction site.
- Require that all employees, subcontractors, and suppliers utilize the stabilized construction access.
- Implement SE-7, Street Sweeping and Vacuuming, as needed.
- All exit locations intended to be used for more than a two-week period should have stabilized construction entrance/exit BMPs.

Inspection and Maintenance

- Inspect and verify that activity-based BMPs are in place prior to the commencement of associated activities. While activities associated with the BMPs are under way, inspect BMPs in accordance with General Permit requirements for the associated project type and risk level. It is recommended that at a minimum, BMPs be inspected weekly, prior to forecasted rain events, daily during extended rain events, and after the conclusion of rain events.
- Inspect local roads adjacent to the site daily. Sweep or vacuum to remove visible accumulated sediment.
- Remove aggregate, separate and dispose of sediment if construction entrance/exit is clogged with sediment.
- Keep all temporary roadway ditches clear.
- Check for damage and repair as needed.
- Replace gravel material when surface voids are visible.
- Remove all sediment deposited on paved roadways within 24 hours.
- Remove gravel and filter fabric at completion of construction

Costs

Average annual cost for installation and maintenance may vary from \$1,200 to \$4,800 each, averaging \$2,400 per entrance. Costs will increase with addition of washing rack, and sediment trap. With wash rack, costs range from \$1,200 - \$6,000 each, averaging \$3,600 per entrance.

References

Manual of Standards of Erosion and Sediment Control Measures, Association of Bay Area Governments, May 1995.

Stabilized Construction Entrance/Exit TC-1

National Management Measures to Control Nonpoint Source Pollution from Urban Areas, USEPA Agency, 2002.

Proposed Guidance Specifying Management Measures for Sources of Nonpoint Pollution in Coastal Waters, Work Group Working Paper, USEPA, April 1992.

Stormwater Quality Handbooks Construction Site Best Management Practices (BMPs) Manual, State of California Department of Transportation (Caltrans), November 2000.

Stormwater Management of the Puget Sound Basin, Technical Manual, Publication #91-75, Washington State Department of Ecology, February 1992.

Virginia Erosion and Sedimentation Control Handbook, Virginia Department of Conservation and Recreation, Division of Soil and Water Conservation, 1991.

Guidance Specifying Management Measures for Nonpoint Pollution in Coastal Waters, EPA 840-B-9-002, USEPA, Office of Water, Washington, DC, 1993.

Water Quality Management Plan for the Lake Tahoe Region, Volume II, Handbook of Management Practices, Tahoe Regional Planning Agency, November 1988.

Stabilized Construction Entrance/Exit TC-1

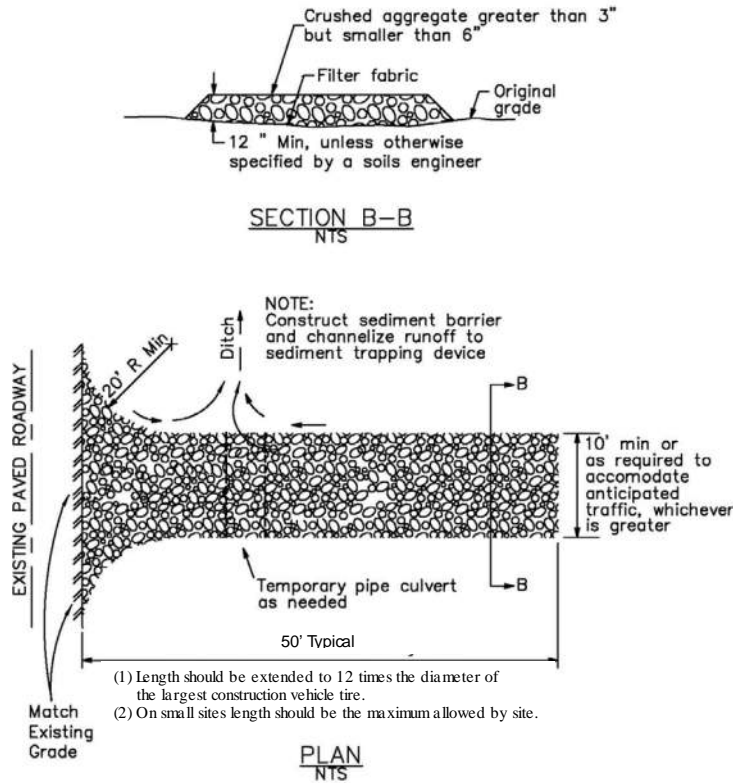

Stabilized Construction Entrance/Exit TC-1

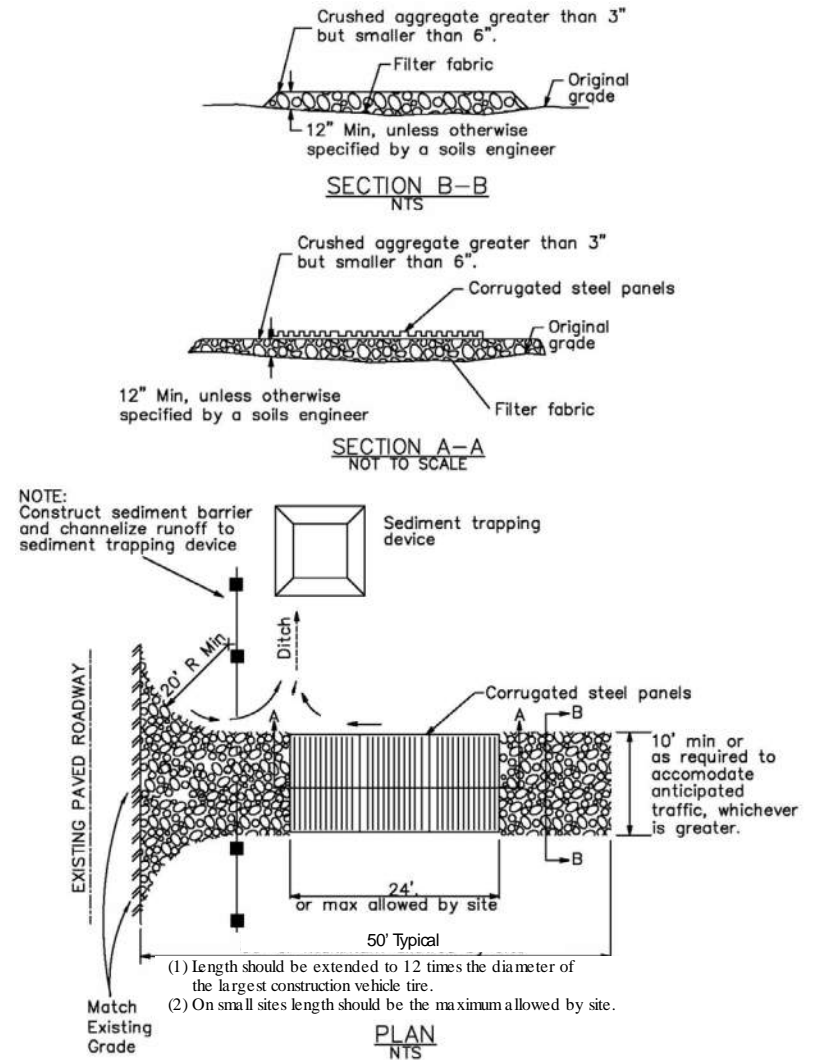

Wind Erosion Control

WE-1

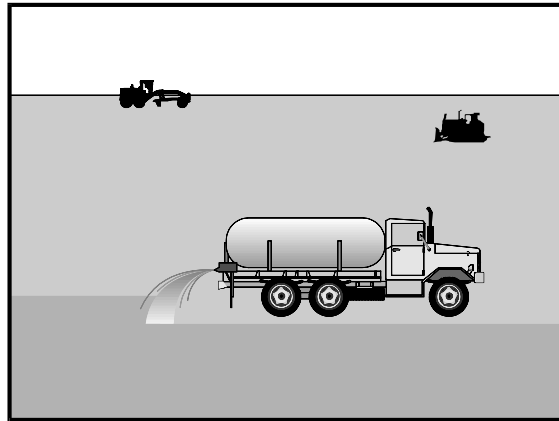

Description and Purpose

Wind erosion or dust control consists of applying water or other chemical dust suppressants as necessary to prevent or alleviate dust nuisance generated by construction activities. Covering small stockpiles or areas is an alternative to applying water or other dust palliatives.

California's Mediterranean climate, with a short "wet" season and a typically long, hot "dry" season, allows the soils to thoroughly dry out. During the dry season, construction activities are at their peak, and disturbed and exposed areas are increasingly subject to wind erosion, sediment tracking and dust generated by construction equipment. Site conditions and climate can make dust control more of an erosion problem than water based erosion. Additionally, many local agencies, including Air Quality Management Districts, require dust control and/or dust control permits in order to comply with local nuisance laws, opacity laws (visibility impairment) and the requirements of the Clean Air Act. Wind erosion control is required to be implemented at all construction sites greater than 1 acre by the General Permit.

Suitable Applications

Most BMPs that provide protection against water-based erosion will also protect against wind-based erosion and dust control requirements required by other agencies will generally meet wind erosion control requirements for water quality protection. Wind erosion control BMPs are suitable during the following construction activities:

Categories

EC	Erosion Control	
SE	Sediment Control	<input checked="" type="checkbox"/>
TC	Tracking Control	
WE	Wind Erosion Control	<input checked="" type="checkbox"/>
NS	Non-Stormwater Management Control	
WM	Waste Management and Materials Pollution Control	

Legend:

- Primary Category
- Secondary Category

Targeted Constituents

Sediment	<input checked="" type="checkbox"/>
Nutrients	
Trash	
Metals	
Bacteria	
Oil and Grease	
Organics	

Potential Alternatives

EC-5 Soil Binders

If User/Subscriber modifies this fact sheet in any way, the CASQA name/logo and footer below must be removed from each page and not appear on the modified version.



Wind Erosion Control

WE-1

- Construction vehicle traffic on unpaved roads
- Drilling and blasting activities
- Soils and debris storage piles
- Batch drop from front-end loaders
- Areas with unstabilized soil
- Final grading/site stabilization

Limitations

- Watering prevents dust only for a short period (generally less than a few hours) and should be applied daily (or more often) to be effective.
- Over watering may cause erosion and track-out.
- Oil or oil-treated subgrade should not be used for dust control because the oil may migrate into drainageways and/or seep into the soil.
- Chemical dust suppression agents may have potential environmental impacts. Selected chemical dust control agents should be environmentally benign.
- Effectiveness of controls depends on soil, temperature, humidity, wind velocity and traffic.
- Chemical dust suppression agents should not be used within 100 feet of wetlands or water bodies.
- Chemically treated subgrades may make the soil water repellant, interfering with long-term infiltration and the vegetation/re-vegetation of the site. Some chemical dust suppressants may be subject to freezing and may contain solvents and should be handled properly.
- In compacted areas, watering and other liquid dust control measures may wash sediment or other constituents into the drainage system.
- If the soil surface has minimal natural moisture, the affected area may need to be pre-wetted so that chemical dust control agents can uniformly penetrate the soil surface.

Implementation

Dust Control Practices

Dust control BMPs generally stabilize exposed surfaces and minimize activities that suspend or track dust particles. The following table presents dust control practices that can be applied to varying site conditions that could potentially cause dust. For heavily traveled and disturbed areas, wet suppression (watering), chemical dust suppression, gravel asphalt surfacing, temporary gravel construction entrances, equipment wash-out areas, and haul truck covers can be employed as dust control applications. Permanent or temporary vegetation and mulching can be employed for areas of occasional or no construction traffic. Preventive measures include minimizing surface areas to be disturbed, limiting onsite vehicle traffic to 15 mph or less, and controlling the number and activity of vehicles on a site at any given time.

Wind Erosion Control

WE-1

Chemical dust suppressants include: mulch and fiber based dust palliatives (e.g. paper mulch with gypsum binder), salts and brines (e.g. calcium chloride, magnesium chloride), non-petroleum based organics (e.g. vegetable oil, lignosulfonate), petroleum based organics (e.g. asphalt emulsion, dust oils, petroleum resins), synthetic polymers (e.g. polyvinyl acetate, vinyls, acrylic), clay additives (e.g. bentonite, montmorillonite) and electrochemical products (e.g. enzymes, ionic products).

Site Condition	Dust Control Practices							
	Permanent Vegetation	Mulching	Wet Suppression (Watering)	Chemical Dust Suppression	Gravel or Asphalt	Temporary Gravel Construction Entrances/Equipment Wash Down	Synthetic Covers	Minimize Extent of Disturbed Area
Disturbed Areas not Subject to Traffic	X	X	X	X	X			X
Disturbed Areas Subject to Traffic			X	X	X	X		X
Material Stockpiles		X	X	X			X	X
Demolition			X			X	X	
Clearing/Excavation			X	X				X
Truck Traffic on Unpaved Roads			X	X	X	X	X	
Tracking					X	X		

Additional preventive measures include:

- Schedule construction activities to minimize exposed area (see EC-1, Scheduling).
- Quickly treat exposed soils using water, mulching, chemical dust suppressants, or stone/gravel layering.
- Identify and stabilize key access points prior to commencement of construction.
- Minimize the impact of dust by anticipating the direction of prevailing winds.
- Restrict construction traffic to stabilized roadways within the project site, as practicable.
- Water should be applied by means of pressure-type distributors or pipelines equipped with a spray system or hoses and nozzles that will ensure even distribution.
- All distribution equipment should be equipped with a positive means of shutoff.
- Unless water is applied by means of pipelines, at least one mobile unit should be available at all times to apply water or dust palliative to the project.
- If reclaimed waste water is used, the sources and discharge must meet California Department of Health Services water reclamation criteria and the Regional Water Quality

Wind Erosion Control

WE-1

Control Board (RWQCB) requirements. Non-potable water should not be conveyed in tanks or drain pipes that will be used to convey potable water and there should be no connection between potable and non-potable supplies. Non-potable tanks, pipes, and other conveyances should be marked, "NON-POTABLE WATER - DO NOT DRINK."

- Pave or chemically stabilize access points where unpaved traffic surfaces adjoin paved roads.
- Provide covers for haul trucks transporting materials that contribute to dust.
- Provide for rapid clean up of sediments deposited on paved roads. Furnish stabilized construction road entrances and wheel wash areas.
- Stabilize inactive areas of construction sites using temporary vegetation or chemical stabilization methods.

For chemical stabilization, there are many products available for chemically stabilizing gravel roadways and stockpiles. If chemical stabilization is used, the chemicals should not create any adverse effects on stormwater, plant life, or groundwater and should meet all applicable regulatory requirements.

Costs

Installation costs for water and chemical dust suppression vary based on the method used and the length of effectiveness. Annual costs may be high since some of these measures are effective for only a few hours to a few days.

Inspection and Maintenance

- Inspect and verify that activity-based BMPs are in place prior to the commencement of associated activities.
- BMPs must be inspected in accordance with General Permit requirements for the associated project type and risk level. It is recommended that at a minimum, BMPs be inspected weekly, prior to forecasted rain events, daily during extended rain events, and after the conclusion of rain events.
- Check areas protected to ensure coverage.
- Most water-based dust control measures require frequent application, often daily or even multiple times per day. Obtain vendor or independent information on longevity of chemical dust suppressants.

References

Best Management Practices and Erosion Control Manual for Construction Sites, Flood Control District of Maricopa County, Arizona, September 1992.

California Air Pollution Control Laws, California Air Resources Board, updated annually.

Construction Manual, Chapter 4, Section 10, "Dust Control"; Section 17, "Watering"; and Section 18, "Dust Palliative", California Department of Transportation (Caltrans), July 2001.

Wind Erosion Control

WE-1

Prospects for Attaining the State Ambient Air Quality Standards for Suspended Particulate Matter (PM10), Visibility Reducing Particles, Sulfates, Lead, and Hydrogen Sulfide, California Air Resources Board, April 1991.

Stormwater Quality Handbooks Construction Site Best Management Practices (BMPs) Manual, State of California Department of Transportation (Caltrans), March 2003.

Water Conservation Practices

NS-1

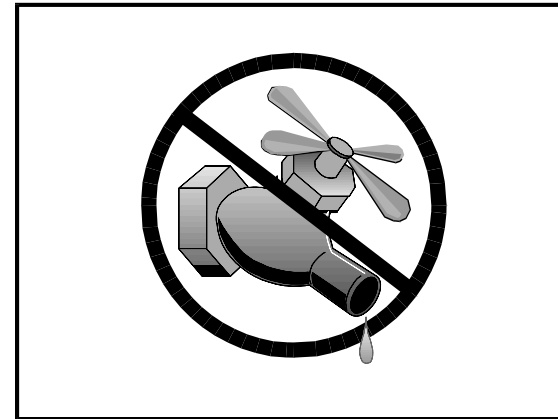

Description and Purpose

Water conservation practices are activities that use water during the construction of a project in a manner that avoids causing erosion and the transport of pollutants offsite. These practices can reduce or eliminate non-stormwater discharges.

Suitable Applications

Water conservation practices are suitable for all construction sites where water is used, including piped water, metered water, trucked water, and water from a reservoir.

Limitations

- None identified.

Implementation

- Keep water equipment in good working condition.
- Stabilize water truck filling area.
- Repair water leaks promptly.
- Washing of vehicles and equipment on the construction site is discouraged.
- Avoid using water to clean construction areas. If water must be used for cleaning or surface preparation, surface should be swept and vacuumed first to remove dirt. This will minimize amount of water required.

Categories

EC	Erosion Control	<input checked="" type="checkbox"/>
SE	Sediment Control	<input checked="" type="checkbox"/>
TC	Tracking Control	
WE	Wind Erosion Control	
NS	Non-Stormwater Management Control	<input checked="" type="checkbox"/>
WM	Waste Management and Materials Pollution Control	

Legend:

- Primary Objective
- Secondary Objective

Targeted Constituents

Sediment	<input checked="" type="checkbox"/>
Nutrients	
Trash	
Metals	
Bacteria	
Oil and Grease	
Organics	

Potential Alternatives

None

If User/Subscriber modifies this fact sheet in any way, the CASQA name/logo and footer below must be removed from each page and not appear on the modified version.



Water Conservation Practices

NS-1

- Direct construction water runoff to areas where it can soak into the ground or be collected and reused.
- Authorized non-stormwater discharges to the storm drain system, channels, or receiving waters are acceptable with the implementation of appropriate BMPs.
- Lock water tank valves to prevent unauthorized use.

Costs

The cost is small to none compared to the benefits of conserving water.

Inspection and Maintenance

- Inspect and verify that activity based BMPs are in place prior to the commencement of authorized non-stormwater discharges.
- Inspect BMPs in accordance with General Permit requirements for the associated project type and risk level. It is recommended that at a minimum, BMPs be inspected weekly, prior to forecasted rain events, daily during extended rain events, and after the conclusion of rain events.
- Inspect BMPs subject to non-stormwater discharges daily while non-stormwater discharges are occurring.
- Repair water equipment as needed to prevent unintended discharges.
 - Water trucks
 - Water reservoirs (water buffalos)
 - Irrigation systems
 - Hydrant connections

References

Stormwater Quality Handbooks - Construction Site Best Management Practices (BMPs) Manual, State of California Department of Transportation (Caltrans), November 2000.

Clear Water Diversion

NS-5

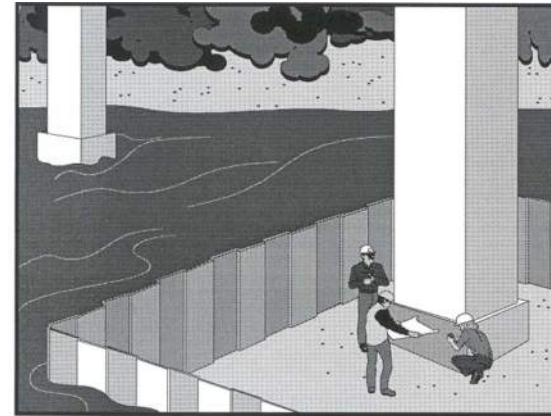

Description and Purpose

Clear water diversion consists of a system of structures and measures that intercept clear surface water runoff upstream of a project, transport it around the work area, and discharge it downstream with minimal water quality degradation from either the project construction operations or the construction of the diversion. Clear water diversions are used in a waterway to enclose a construction area and reduce sediment pollution from construction work occurring in or adjacent to water. Structures commonly used as part of this system include diversion ditches, berms, dikes, slope drains, rock, gravel bags, wood, aqua barriers, cofferdams, filter fabric or turbidity curtains, drainage and interceptor swales, pipes, or flumes.

Suitable Applications

A clear water diversion is typically implemented where appropriate permits (1601 Agreement) have been secured and work must be performed in a flowing stream or water body.

- Clear water diversions are appropriate for isolating construction activities occurring within or near a water body such as streambank stabilization, or culvert, bridge, pier or abutment installation. They may also be used in combination with other methods, such as clear water bypasses and/or pumps.
- Pumped diversions are suitable for intermittent and low flow streams.
- Excavation of a temporary bypass channel, or passing the flow through a heavy pipe (called a "flume") with a trench

Categories

EC	Erosion Control	
SE	Sediment Control	
TC	Tracking Control	
WE	Wind Erosion Control	
NS	Non-Stormwater Management Control	<input checked="" type="checkbox"/>
WM	Waste Management and Materials Pollution Control	

Legend:

- Primary Objective
- Secondary Objective

Targeted Constituents

Sediment	<input checked="" type="checkbox"/>
Nutrients	
Trash	
Metals	
Bacteria	
Oil and Grease	
Organics	

Potential Alternatives

None

If User/Subscriber modifies this fact sheet in any way, the CASQA name/logo and footer below must be removed from each page and not appear on the modified version.



excavated under it, is appropriate for the diversion of streams less than 20 ft wide, with flow rates less than 100 cfs.

- Clear water diversions incorporating clean washed gravel may be appropriate for use in salmonid spawning streams.

Limitations

- Diversion and encroachment activities will usually disturb the waterway during installation and removal of diversion structures.
- Installation may require Regional Water Quality Control Board (RWQCB) 401 Certification, U.S. Army Corps of Engineers 404 permit and approval by California Department of Fish and Game. If numerical-based water quality standards are mentioned in any of these and other related permits, testing and sampling may be required.
- Diversion and encroachment activities may constrict the waterway, which can obstruct flood flows and cause flooding or washouts. Diversion structures should not be installed without identifying potential impacts to the stream channel.
- Diversion or isolation activities are not appropriate in channels where there is insufficient stream flow to support aquatic species in the area dewatered as a result of the diversion.
- Diversion or isolation activities are inappropriate in deep water unless designed or reviewed by an engineer registered in California.
- Diversion or isolation activities should not completely dam stream flow.
- Dewatering and removal may require additional sediment control or water treatment. See NS-2, Dewatering Operations.
- Not appropriate if installation, maintenance, and removal of the structures will disturb sensitive aquatic species of concern.

Implementation

General

- Implement guidelines presented in EC-12, Streambank Stabilization to minimize impacts to streambanks.
- Where working areas encroach on flowing streams, barriers adequate to prevent the flow of muddy water into streams should be constructed and maintained between working areas and streams. During construction of the barriers, muddying of streams should be held to a minimum.
- Diversion structures must be adequately designed to accommodate fluctuations in water depth or flow volume due to tides, storms, flash floods, etc.
- Heavy equipment driven in wet portions of a water body to accomplish work should be completely clean of petroleum residue, and water levels should be below the fuel tanks, gearboxes, and axles of the equipment unless lubricants and fuels are sealed such that inundation by water will not result in discharges of fuels, oils, greases, or hydraulic fluids.

- Excavation equipment buckets may reach out into the water for the purpose of removing or placing fill materials. Only the bucket of the crane/ excavator/backhoe may operate in a water body. The main body of the crane/excavator/backhoe should not enter the water body except as necessary to cross the stream to access the work site.
- Stationary equipment such as motors and pumps located within or adjacent to a water body, should be positioned over drip pans.
- When any artificial obstruction is being constructed, maintained, or placed in operation, sufficient water should, at all times, be allowed to pass downstream to maintain aquatic life.
- Equipment should not be parked below the high water mark unless allowed by a permit.
- Disturbance or removal of vegetation should not exceed the minimum necessary to complete operations. Precautions should be taken to avoid damage to vegetation by people or equipment. Disturbed vegetation should be replaced with the appropriate erosion control measures.
- Riparian vegetation approved for trimming as part of the project should be cut off no lower than ground level to promote rapid re-growth. Access roads and work areas built over riparian vegetation should be covered by a sufficient layer of clean river run cobble to prevent damage to the underlying soil and root structure. The cobble should be removed upon completion of project activities.
- Drip pans should be placed under all vehicles and equipment placed on docks, barges, or other structures over water bodies when the vehicle or equipment is planned to be idle for more than 1 hour.
- Where possible, avoid or minimize diversion and encroachment impacts by scheduling construction during periods of low flow or when the stream is dry. Scheduling should also consider seasonal releases of water from dams, fish migration and spawning seasons, and water demands due to crop irrigation.
- Construct diversion structures with materials free of potential pollutants such as soil, silt, sand, clay, grease, or oil.

Temporary Diversions and Encroachments

- Construct diversion channels in accordance with EC-9, Earth Dikes and Drainage Swales.
- In high flow velocity areas, stabilize slopes of embankments and diversion ditches using an appropriate liner, in accordance with EC-7, Geotextiles and Mats, or use rock slope protection.
- Where appropriate, use natural streambed materials such as large cobbles and boulders for temporary embankment and slope protection, or other temporary soil stabilization methods.
- Provide for velocity dissipation at transitions in the diversion, such as the point where the stream is diverted to the channel and the point where the diverted stream is returned to its natural channel. See also EC-10, Velocity Dissipation Devices.

Temporary Dry Construction Areas

- When dewatering behind temporary structures to create a temporary dry construction area, such as cofferdams, pass pumped water through a sediment-settling device, such as a portable tank or settling basin, before returning water to the water body. See also NS-2, Dewatering Operations.
- Any substance used to assemble or maintain diversion structures, such as form oil, should be non-toxic and non-hazardous.
- Any material used to minimize seepage underneath diversion structures, such as grout, should be non-toxic, non-hazardous, and as close to a neutral pH as possible.

Comparison of Diversion and Isolation Techniques:

- Gravel bags are relatively inexpensive, but installation and removal can be labor intensive. It is also difficult to dewater the isolated area. Sandbags should not be used for this technique in rivers or streams, as sand should never be put into or adjacent to a stream, even if encapsulated in geotextile.
- Gravel Bag Berms (SE-6) used in conjunction with an impermeable membrane are cost effective, and can be dewatered relatively easily. If spawning gravel is used, the impermeable membrane can be removed from the stream, and the gravel can be spread out and left as salmonid spawning habitat if approved in the permit. Only clean, washed gravel should be used for both the gravel bag and gravel berm techniques.
- Cofferdams are relatively expensive, but frequently allow full dewatering. Also, many options now available are relatively easy to install.
- Sheet pile enclosures are a much more expensive solution, but do allow full dewatering. This technique is not well suited to small streams, but can be effective on large rivers or lakes, and where staging and heavy equipment access areas are available.
- K-rails are an isolation method that does not allow full dewatering, but can be used in small to large watercourses, and in fast-water situations.
- A relatively inexpensive isolation method is filter fabric isolation. This method involves placement of gravel bags or continuous berms to 'key-in' the fabric, and subsequently staking the fabric in place. This method should be used in relatively calm water, and can be used in smaller streams. Note that this is not a dewatering method, but rather a sediment isolation method.
- Turbidity curtains should be used where sediment discharge to a stream is unavoidable. They can also be used for in-stream construction, when dewatering an area is not required.
- When used in watercourses or streams, cofferdams must be used in accordance with permit requirements.
- Manufactured diversion structures should be installed following manufacturer's specifications.

- Filter fabric and turbidity curtain isolation installation methods can be found in the specific technique descriptions that follow.

Filter Fabric Isolation Technique

Definition and Purpose

A filter fabric isolation structure is a temporary structure built into a waterway to enclose a construction area and reduce sediment pollution from construction work in or adjacent to water. This structure is composed of filter fabric, gravel bags, and steel t-posts.

Appropriate Applications

- Filter fabric may be used for construction activities such as streambank stabilization, or culvert, bridge, pier or abutment installation. It may also be used in combination with other methods, such as clean water bypasses and/or pumps.
- Filter fabric isolation is relatively inexpensive. This method involves placement of gravel bags or continuous berms to 'key-in' the fabric, and subsequently staking the fabric in place.
- If spawning gravel is used, all other components of the isolation can be removed from the stream, and the gravel may be spread out and left as salmonid spawning habitat if approved in the permit. Whether spawning gravel or other types of gravel are used, only clean washed gravel should be used as infill for the gravel bags or continuous berm.
- This method should be used in relatively calm water, and can be used in smaller streams. This is not a dewatering method, but rather a sediment isolation method.
- Water levels inside and outside the fabric curtain must be about the same, as differential heads will cause the curtain to collapse.

Limitations

- Do not use if the installation, maintenance and removal of the structures will disturb sensitive aquatic species of concern.
- Filter fabrics are not appropriate for projects where dewatering is necessary.
- Filter fabrics are not appropriate to completely dam stream flow.

Design and Installation

- For the filter fabric isolation method, a non-woven or heavy-duty fabric is recommended over standard silt fence. Using rolled geotextiles allows non-standard widths to be used.
- Anchor filter fabric with gravel bags filled with clean, washed gravel. Do not use sand. If a bag should split open, the gravel can be left in the stream, where it can provide aquatic habitat benefits. If a sandbag splits open in a watercourse, the sand could cause a decrease in water quality, and could bury sensitive aquatic habitat.
- Another anchor alternative is a continuous berm, made with the Continuous Berm Machine. This is a gravel-filled bag that can be made in very long segments. The length of the berms is usually limited to 18 ft for ease of handling (otherwise, it gets too heavy to move).

- Place the fabric on the bottom of the stream, and place either a bag of clean, washed gravel or a continuous berm over the bottom of the silt fence fabric, such that a bag-width of fabric lies on the stream bottom. The bag should be placed on what will be the outside of the isolation area.
- Pull the fabric up, and place a metal t-post immediately behind the fabric, on the inside of the isolation area; attach the silt fence to the post with three diagonal nylon ties.
- Continue placing fabric as described above until the entire work area has been isolated, staking the fabric at least every 6 ft.

Inspection and Maintenance

- Immediately repair any gaps, holes or scour.
- Remove and properly dispose of sediment buildup.
- Remove BMP upon completion of construction activity. Recycle or reuse if applicable.
- Revegetate areas disturbed by BMP removal if needed.

Turbidity Curtain Isolation Technique

Definition and Purpose

A turbidity curtain is a fabric barrier used to isolate the near shore work area. The barriers are intended to confine the suspended sediment. The curtain is a floating barrier, and thus does not prevent water from entering the isolated area; rather, it prevents suspended sediment from getting out.

Appropriate Applications

Turbidity curtains should be used where sediment discharge to a stream is unavoidable. They are used when construction activities adjoin quiescent waters, such as lakes, ponds, and slow flowing rivers. The curtains are designed to deflect and contain sediment within a limited area and provide sufficient retention time so that the sediment particles will fall out of suspension.

Limitations

- Turbidity curtains should not be used in flowing water; they are best suited for use in ponds, lakes, and very slow-moving rivers.
- Turbidity curtains should not be placed across the width of a channel.
- Removing sediment that has been deflected and settled out by the curtain may create a discharge problem through the resuspension of particles and by accidental dumping by the removal equipment.

Design and Installation

- Turbidity curtains should be oriented parallel to the direction of flow.
- The curtain should extend the entire depth of the watercourse in calm-water situations.
- In wave conditions, the curtain should extend to within 1 ft of the bottom of the watercourse, such that the curtain does not stir up sediment by hitting the bottom repeatedly. If it is

desirable for the curtain to reach the bottom in an active-water situation, a pervious filter fabric may be used for the bottom 1 ft.

- The top of the curtain should consist of flexible flotation buoys, and the bottom should be held down by a load line incorporated into the curtain fabric. The fabric should be a brightly colored impervious mesh.
- The curtain should be held in place by anchors placed at least every 100 ft.
- First, place the anchors, then tow the fabric out in a furled condition, and connect to the anchors. The anchors should be connected to the flotation devices, and not to the bottom of the curtain. Once in place, cut the furling lines, and allow the bottom of the curtain to sink.
- Consideration must be given to the probable outcome of the removal procedure. It must be determined if it will create more of a sediment problem through re-suspension of the particles or by accidental dumping of material during removal. It is recommended that the soil particles trapped by the turbidity curtain only be removed if there has been a significant change in the original contours of the affected area in the watercourse.
- Particles should always be allowed to settle for a minimum of 6 to 12 hours prior to their removal or prior to removal of the turbidity curtain.

Maintenance and Inspection:

- The curtain should be inspected for holes or other problems, and any repairs needed should be made promptly.
- Allow sediment to settle for 6 to 12 hours prior to removal of sediment or curtain. This means that after removing sediment, wait an additional 6 to 12 hours before removing the curtain.
- To remove, install furling lines along the curtain, detach from anchors, and tow out of the water.

K-rail River Isolation

Definition and Purpose

This temporary sediment control or stream isolation method uses K-rails to form the sediment deposition area, or to isolate the in-stream or near-bank construction area.

Barriers are placed end-to-end in a pre-designed configuration and gravel-filled bags are used at the toe of the barrier and at their abutting ends to seal and prevent movement of sediment beneath or through the barrier walls.

Appropriate Applications

The K-rail isolation can be used in streams with higher water velocities than many other isolation techniques.

- This technique is also useful at the toe of embankments, and cut or fill slopes.

Limitations

- The K-rail method should not be used to dewater a project site, as the barrier is not watertight.

Design and Installation

- To create a floor for the K-rail, move large rocks and obstructions. Place washed gravel and gravel-filled bags to create a level surface for K-rails to sit. Washed gravel should always be used.
- Place the bottom two K-rails adjacent to each other, and parallel to the direction of flow; fill the center portion with gravel bags. Then place the third K-rail on top of the bottom two. There should be sufficient gravel bags between the bottom K-rails such that the top rail is supported by the gravel. Place plastic sheeting around the K-rails, and secure at the bottom with gravel bags.
- Further support can be added by pinning and cabling the K-rails together. Also, large riprap and boulders can be used to support either side of the K-rail, especially where there is strong current.

Inspection and Maintenance:

- The barrier should be inspected and any leaks, holes, or other problems should be addressed immediately.
- Sediment should be allowed to settle for at least 6 to 12 hours prior to removal of sediment, and for 6 to 12 hours prior to removal of the barrier.

Stream Diversions

The selection of which stream diversion technique to use will depend upon the type of work involved, physical characteristics of the site, and the volume of water flowing through the project.

Advantages of a Pumped Diversion

- Downstream sediment transport can be nearly eliminated.
- Dewatering of the work area is possible.
- Pipes can be moved around to allow construction operations.
- The dams can serve as temporary access to the site.
- Increased flows can be managed by adding more pumping capacity.

Disadvantages of a Pumped Diversion

- Flow volume is limited by pump capacity.
- A pumped diversion requires 24 hour monitoring of pumps.
- Sudden rain could overtop dams.
- Erosion at the outlet.

- Minor in-stream disturbance is required to install and remove dams.

Advantages of Excavated Channels and Flumes

- Excavated channels isolate work from water flow and allow dewatering.
- Excavated channels can handle larger flows than pumps.

Disadvantages of Excavated Channels and Flumes

- Bypass channel or flume must be sized to handle flows, including possible floods.
- Channels must be protected from erosion.
- Flow diversion and re-direction with small dams involves in-stream disturbance and mobilization of sediment.

Design and Installation

- Installation guidelines will vary based on existing site conditions and type of diversion used.
- Pump capacity must be sufficient for design flow.
- A standby pump is required in case a primary pump fails.
- Dam materials used to create dams upstream and downstream of diversion should be erosion resistant; materials such as steel plate, sheet pile, sandbags, continuous berms, inflatable water bladders, etc., would be acceptable.

When constructing a diversion channel, begin excavation of the channel at the proposed downstream end, and work upstream. Once the watercourse to be diverted is reached and the excavated channel is stable, breach the upstream end and allow water to flow down the new channel. Once flow has been established in the diversion channel, install the diversion weir in the main channel; this will force all water to be diverted from the main channel.

Inspection and Maintenance

- Pumped diversions require 24 hour monitoring of pumps.
- Inspect embankments and diversion channels for damage to the linings, accumulating debris, sediment buildup, and adequacy of the slope protection. Remove debris and repair linings and slope protection as required. Remove holes, gaps, or scour.
- Upon completion of work, the diversion or isolation structure should be removed and flow should be redirected through the new culvert or back into the original stream channel. Recycle or reuse if applicable.
- Revegetate areas disturbed by BMP removal if needed.

Costs

Costs of clear water diversion vary considerably and can be very high.

Clear Water Diversion

NS-5

Inspection and Maintenance

- Inspect and verify that activity-based BMPs are in place prior to the commencement of associated activities. While activities associated with the BMP are under way, inspect BMPs in accordance with General Permit requirements for the associated project type and risk level. It is recommended that at a minimum, BMPs be inspected weekly, prior to forecasted rain events, daily during extended rain events, and after the conclusion of rain events.
- Inspect BMPs subject to non-stormwater discharges daily while non-stormwater discharges occur.
- Refer to BMP-specific inspection and maintenance requirements.

References

California Bank and Shore Rock Slope Protection Design – Practitioners Guide and Field Evaluations of Riprap Methods, Caltrans Study No. F90TL03, October, 2000.

Stormwater Quality Handbooks - Construction Site Best Management Practices (BMPs) Manual, State of California Department of Transportation (Caltrans), November 2000.

Vehicle and Equipment Fueling

NS-9

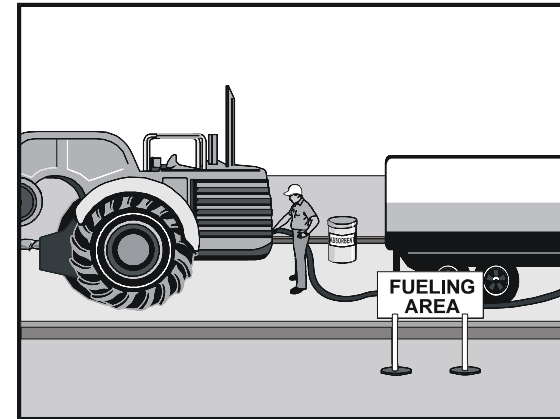

Description and Purpose

Vehicle equipment fueling procedures and practices are designed to prevent fuel spills and leaks, and reduce or eliminate contamination of stormwater. This can be accomplished by using offsite facilities, fueling in designated areas only, enclosing or covering stored fuel, implementing spill controls, and training employees and subcontractors in proper fueling procedures.

Suitable Applications

These procedures are suitable on all construction sites where vehicle and equipment fueling takes place.

Limitations

Onsite vehicle and equipment fueling should only be used where it is impractical to send vehicles and equipment offsite for fueling. Sending vehicles and equipment offsite should be done in conjunction with TC-1, Stabilized Construction Entrance/ Exit.

Implementation

- Use offsite fueling stations as much as possible. These businesses are better equipped to handle fuel and spills properly. Performing this work offsite can also be economical by eliminating the need for a separate fueling area at a site.
- Discourage “topping-off” of fuel tanks.

Categories

EC	Erosion Control	
SE	Sediment Control	
TC	Tracking Control	
WE	Wind Erosion Control	
NS	Non-Stormwater Management Control	<input checked="" type="checkbox"/>
WM	Waste Management and Materials Pollution Control	

Legend:

- Primary Objective
- Secondary Objective

Targeted Constituents

Sediment	
Nutrients	
Trash	
Metals	
Bacteria	
Oil and Grease	<input checked="" type="checkbox"/>
Organics	

Potential Alternatives

None

If User/Subscriber modifies this fact sheet in any way, the CASQA name/logo and footer below must be removed from each page and not appear on the modified version.



Vehicle and Equipment Fueling NS-9

- Absorbent spill cleanup materials and spill kits should be available in fueling areas and on fueling trucks, and should be disposed of properly after use.
- Drip pans or absorbent pads should be used during vehicle and equipment fueling, unless the fueling is performed over an impermeable surface in a dedicated fueling area.
- Use absorbent materials on small spills. Do not hose down or bury the spill. Remove the adsorbent materials promptly and dispose of properly.
- Avoid mobile fueling of mobile construction equipment around the site; rather, transport the equipment to designated fueling areas. With the exception of tracked equipment such as bulldozers and large excavators, most vehicles should be able to travel to a designated area with little lost time.
- Train employees and subcontractors in proper fueling and cleanup procedures.
- When fueling must take place onsite, designate an area away from drainage courses to be used. Fueling areas should be identified in the SWPPP.
- Dedicated fueling areas should be protected from stormwater runoff and should be located at least 50 ft away from downstream drainage facilities and watercourses. Fueling must be performed on level-grade areas.
- Protect fueling areas with berms and dikes to prevent runoff, and to contain spills.
- Nozzles used in vehicle and equipment fueling should be equipped with an automatic shutoff to control drips. Fueling operations should not be left unattended.
- Use vapor recovery nozzles to help control drips as well as air pollution where required by Air Quality Management Districts (AQMD).
- Federal, state, and local requirements should be observed for any stationary above ground storage tanks.

Costs

- All of the above measures are low cost except for the capital costs of above ground tanks that meet all local environmental, zoning, and fire codes.

Inspection and Maintenance

- Inspect BMPs in accordance with General Permit requirements for the associated project type and risk level. It is recommended that at a minimum, BMPs be inspected weekly, prior to forecasted rain events, daily during extended rain events, and after the conclusion of rain events.
- Vehicles and equipment should be inspected each day of use for leaks. Leaks should be repaired immediately or problem vehicles or equipment should be removed from the project site.
- Keep ample supplies of spill cleanup materials onsite.

Vehicle and Equipment Fueling NS-9

- Immediately clean up spills and properly dispose of contaminated soil and cleanup materials.

References

Blueprint for a Clean Bay: Best Management Practices to Prevent Stormwater Pollution from Construction Related Activities; Santa Clara Valley Nonpoint Source Pollution Control Program, 1995.

Coastal Nonpoint Pollution Control Program: Program Development and Approval Guidance, Working Group Working Paper; USEPA, April 1992.

Stormwater Quality Handbooks - Construction Site Best Management Practices (BMPs) Manual, State of California Department of Transportation (Caltrans), November 2000.

Stormwater Management for Construction Activities, Developing Pollution Prevention Plans and Best Management Practices, EPA 832-R-92005; USEPA, April 1992.

Vehicle & Equipment Maintenance NS-10

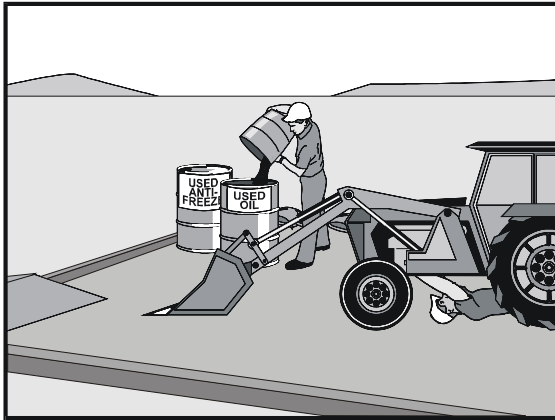

Description and Purpose

Prevent or reduce the contamination of stormwater resulting from vehicle and equipment maintenance by running a “dry and clean site”. The best option would be to perform maintenance activities at an offsite facility. If this option is not available then work should be performed in designated areas only, while providing cover for materials stored outside, checking for leaks and spills, and containing and cleaning up spills immediately. Employees and subcontractors must be trained in proper procedures.

Suitable Applications

These procedures are suitable on all construction projects where an onsite yard area is necessary for storage and maintenance of heavy equipment and vehicles.

Limitations

Onsite vehicle and equipment maintenance should only be used where it is impractical to send vehicles and equipment offsite for maintenance and repair. Sending vehicles/equipment offsite should be done in conjunction with TC-1, Stabilized Construction Entrance/Exit.

Outdoor vehicle or equipment maintenance is a potentially significant source of stormwater pollution. Activities that can contaminate stormwater include engine repair and service, changing or replacement of fluids, and outdoor equipment storage and parking (engine fluid leaks). For further information on vehicle or equipment servicing, see NS-8,

Categories

EC	Erosion Control	
SE	Sediment Control	
TC	Tracking Control	
WE	Wind Erosion Control	
NS	Non-Stormwater Management Control	<input checked="" type="checkbox"/>
WM	Waste Management and Materials Pollution Control	

Legend:

- Primary Objective
- Secondary Objective

Targeted Constituents

Sediment	
Nutrients	<input checked="" type="checkbox"/>
Trash	<input checked="" type="checkbox"/>
Metals	
Bacteria	
Oil and Grease	<input checked="" type="checkbox"/>
Organics	<input checked="" type="checkbox"/>

Potential Alternatives

None

If User/Subscriber modifies this fact sheet in any way, the CASQA name/logo and footer below must be removed from each page and not appear on the modified version.



Vehicle & Equipment Maintenance NS-10

Vehicle and Equipment Cleaning, and NS-9, Vehicle and Equipment Fueling.

Implementation

- Use offsite repair shops as much as possible. These businesses are better equipped to handle vehicle fluids and spills properly. Performing this work offsite can also be economical by eliminating the need for a separate maintenance area.
- If maintenance must occur onsite, use designated areas, located away from drainage courses. Dedicated maintenance areas should be protected from stormwater runoff and should be located at least 50 ft from downstream drainage facilities and watercourses.
- Drip pans or absorbent pads should be used during vehicle and equipment maintenance work that involves fluids, unless the maintenance work is performed over an impermeable surface in a dedicated maintenance area.
- Place a stockpile of spill cleanup materials where it will be readily accessible.
- All fueling trucks and fueling areas are required to have spill kits and/or use other spill protection devices.
- Use adsorbent materials on small spills. Remove the adsorbent materials promptly and dispose of properly.
- Inspect onsite vehicles and equipment daily at startup for leaks, and repair immediately.
- Keep vehicles and equipment clean; do not allow excessive build-up of oil and grease.
- Segregate and recycle wastes, such as greases, used oil or oil filters, antifreeze, cleaning solutions, automotive batteries, hydraulic and transmission fluids. Provide secondary containment and covers for these materials if stored onsite.
- Train employees and subcontractors in proper maintenance and spill cleanup procedures.
- Drip pans or plastic sheeting should be placed under all vehicles and equipment placed on docks, barges, or other structures over water bodies when the vehicle or equipment is planned to be idle for more than 1 hour.
- For long-term projects, consider using portable tents or covers over maintenance areas if maintenance cannot be performed offsite.
- Consider use of new, alternative greases and lubricants, such as adhesive greases, for chassis lubrication and fifth-wheel lubrication.
- Properly dispose of used oils, fluids, lubricants, and spill cleanup materials.
- Do not place used oil in a dumpster or pour into a storm drain or watercourse.
- Properly dispose of or recycle used batteries.
- Do not bury used tires.

Vehicle & Equipment Maintenance NS-10

- Repair leaks of fluids and oil immediately.

Listed below is further information if you must perform vehicle or equipment maintenance onsite.

Safer Alternative Products

- Consider products that are less toxic or hazardous than regular products. These products are often sold under an “environmentally friendly” label.
- Consider use of grease substitutes for lubrication of truck fifth-wheels. Follow manufacturers label for details on specific uses.
- Consider use of plastic friction plates on truck fifth-wheels in lieu of grease. Follow manufacturers label for details on specific uses.

Waste Reduction

Parts are often cleaned using solvents such as trichloroethylene, trichloroethane, or methylene chloride. Many of these cleaners are listed in California Toxic Rule as priority pollutants. These materials are harmful and must not contaminate stormwater. They must be disposed of as a hazardous waste. Reducing the number of solvents makes recycling easier and reduces hazardous waste management costs. Often, one solvent can perform a job as well as two different solvents. Also, if possible, eliminate or reduce the amount of hazardous materials and waste by substituting non-hazardous or less hazardous materials. For example, replace chlorinated organic solvents with non-chlorinated solvents. Non-chlorinated solvents like kerosene or mineral spirits are less toxic and less expensive to dispose of properly. Check the list of active ingredients to see whether it contains chlorinated solvents. The “chlor” term indicates that the solvent is chlorinated. Also, try substituting a wire brush for solvents to clean parts.

Recycling and Disposal

Separating wastes allows for easier recycling and may reduce disposal costs. Keep hazardous wastes separate, do not mix used oil solvents, and keep chlorinated solvents (like, -trichloroethane) separate from non-chlorinated solvents (like kerosene and mineral spirits). Promptly transfer used fluids to the proper waste or recycling drums. Don't leave full drip pans or other open containers lying around. Provide cover and secondary containment until these materials can be removed from the site.

Oil filters can be recycled. Ask your oil supplier or recycler about recycling oil filters.

Do not dispose of extra paints and coatings by dumping liquid onto the ground or throwing it into dumpsters. Allow coatings to dry or harden before disposal into covered dumpsters.

Store cracked batteries in a non-leaking secondary container. Do this with all cracked batteries, even if you think all the acid has drained out. If you drop a battery, treat it as if it is cracked. Put it into the containment area until you are sure it is not leaking.

Costs

All of the above are low cost measures. Higher costs are incurred to setup and maintain onsite maintenance areas.

Vehicle & Equipment Maintenance NS-10

Inspection and Maintenance

- Inspect and verify that activity-based BMPs are in place prior to the commencement of associated activities. While activities associated with the BMP are under way, inspect BMPs in accordance with General Permit requirements for the associated project type and risk level. It is recommended that at a minimum, BMPs be inspected weekly, prior to forecasted rain events, daily during extended rain events, and after the conclusion of rain events.
- Inspect BMPs subject to non-stormwater discharges daily while non-stormwater discharges occur.
- Keep ample supplies of spill cleanup materials onsite.
- Maintain waste fluid containers in leak proof condition.
- Vehicles and equipment should be inspected on each day of use. Leaks should be repaired immediately or the problem vehicle(s) or equipment should be removed from the project site.
- Inspect equipment for damaged hoses and leaky gaskets routinely. Repair or replace as needed.

References

Blueprint for a Clean Bay: Best Management Practices to Prevent Stormwater Pollution from Construction Related Activities; Santa Clara Valley Nonpoint Source Pollution Control Program, 1995.

Coastal Nonpoint Pollution Control Program; Program Development and Approval Guidance, Working Group, Working Paper; USEPA, April 1992.

Stormwater Quality Handbooks - Construction Site Best Management Practices (BMPs) Manual, State of California Department of Transportation (Caltrans), November 2000.

Concrete Curing

NS-12

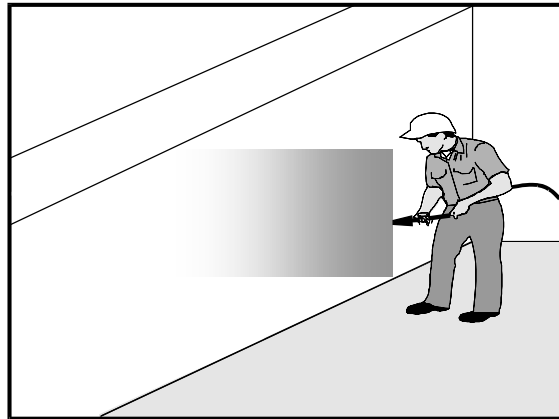

Description and Purpose

Concrete curing is used in the construction of structures such as bridges, retaining walls, pump houses, large slabs, and structured foundations. Concrete curing includes the use of both chemical and water methods.

Concrete and its associated curing materials have basic chemical properties that can raise the pH of water to levels outside of the permitted range. Discharges of stormwater and non-stormwater exposed to concrete during curing may have a high pH and may contain chemicals, metals, and fines. The General Permit incorporates Numeric Action Levels (NAL) for pH (see Section 2 of this handbook to determine your project's risk level and if you are subject to these requirements).

Proper procedures and care should be taken when managing concrete curing materials to prevent them from coming into contact with stormwater flows, which could result in a high pH discharge.

Suitable Applications

Suitable applications include all projects where Portland Cement Concrete (PCC) and concrete curing chemicals are placed where they can be exposed to rainfall, runoff from other areas, or where runoff from the PCC will leave the site.

Limitations

- Runoff contact with concrete waste can raise pH levels in the water to environmentally harmful levels and trigger permit violations.

Categories

EC	Erosion Control	
SE	Sediment Control	
TC	Tracking Control	
WE	Wind Erosion Control	
NS	Non-Stormwater Management Control	<input checked="" type="checkbox"/>
WM	Waste Management and Materials Pollution Control	<input checked="" type="checkbox"/>

Legend:

- Primary Category
- Secondary Category

Targeted Constituents

Sediment	<input checked="" type="checkbox"/>
Nutrients	
Trash	
Metals	<input checked="" type="checkbox"/>
Bacteria	
Oil and Grease	<input checked="" type="checkbox"/>
Organics	

Potential Alternatives

None

If User/Subscriber modifies this fact sheet in any way, the CASQA name/logo and footer below must be removed from each page and not appear on the modified version.



Concrete Curing

NS-12

Implementation

Chemical Curing

- Avoid over spray of curing compounds.
- Minimize the drift by applying the curing compound close to the concrete surface. Apply an amount of compound that covers the surface, but does not allow any runoff of the compound.
- Use proper storage and handling techniques for concrete curing compounds. Refer to WM-1, Material Delivery and Storage.
- Protect drain inlets prior to the application of curing compounds.
- Refer to WM-4, Spill Prevention and Control.

Water Curing for Bridge Decks, Retaining Walls, and other Structures

- Direct cure water away from inlets and watercourses to collection areas for evaporation or other means of removal in accordance with all applicable permits. See WM-8 Concrete Waste Management.
- Collect cure water at the top of slopes and transport to a concrete waste management area in a non-erosive manner. See EC-9 Earth Dikes and Drainage Swales, EC-10, Velocity Dissipation Devices, and EC-11, Slope Drains.
- Utilize wet blankets or a similar method that maintains moisture while minimizing the use and possible discharge of water.

Education

- Educate employees, subcontractors, and suppliers on proper concrete curing techniques to prevent contact with discharge as described herein.
- Arrange for the QSP or the appropriately trained contractor's superintendent or representative to oversee and enforce concrete curing procedures.

Costs

All of the above measures are generally low cost.

Inspection and Maintenance

- Inspect and verify that activity-based BMPs are in place prior to the commencement of associated activities.
- BMPs must be inspected in accordance with General Permit requirements for the associated project type and risk level. It is recommended that at a minimum, BMPs be inspected weekly, prior to forecasted rain events, daily during extended rain events, and after the conclusion of rain events.
- Inspect BMPs subject to non-stormwater discharges daily while non-stormwater discharges occur.

Concrete Curing

NS-12

- Sample non-stormwater discharges and stormwater runoff that contacts uncured and partially cured concrete as required by the General Permit.
- Ensure that employees and subcontractors implement appropriate measures for storage, handling, and use of curing compounds.
- Inspect cure containers and spraying equipment for leaks.

References

Blue Print for a Clean Bay-Construction-Related Industries: Best Management Practices for Stormwater Pollution Prevention; Santa Clara Valley Non Point Source Pollution Control Program, 1992.

Stormwater Quality Handbooks - Construction Site Best Management Practices (BMPs) Manual, State of California Department of Transportation (Caltrans), March 2003.

Stormwater Management for Construction Activities, Developing Pollution Prevention Plans and Best Management Practices, EPA 832-R-92005; USEPA, April 1992.

Erosion and Sediment Control Manual, Oregon Department of Environmental Quality, February 2005.

Concrete Finishing

NS-13

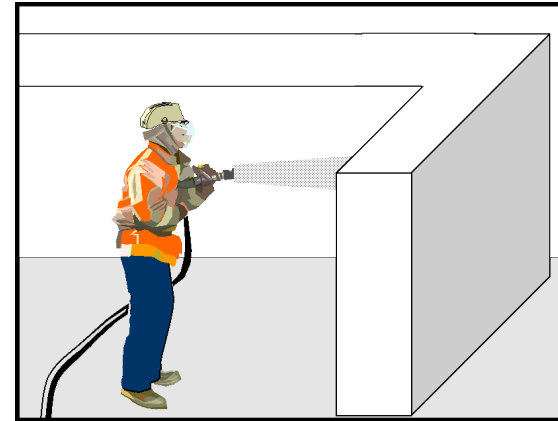

Categories

EC	Erosion Control	
SE	Sediment Control	
TC	Tracking Control	
WE	Wind Erosion Control	
NS	Non-Stormwater Management Control	<input checked="" type="checkbox"/>
WM	Waste Management and Materials Pollution Control	<input checked="" type="checkbox"/>

Legend:

- Primary Category
- Secondary Category

Targeted Constituents

Sediment	<input checked="" type="checkbox"/>
Nutrients	
Trash	
Metals	<input checked="" type="checkbox"/>
Bacteria	
Oil and Grease	
Organics	<input checked="" type="checkbox"/>

Potential Alternatives

None

If User/Subscriber modifies this fact sheet in any way, the CASQA name/logo and footer below must be removed from each page and not appear on the modified version.

Description and Purpose

Concrete finishing methods are used for bridge deck rehabilitation, paint removal, curing compound removal, and final surface finish appearances. Methods include sand blasting, shot blasting, grinding, or high pressure water blasting. Stormwater and non-stormwater exposed to concrete finishing by-products may have a high pH and may contain chemicals, metals, and fines. Proper procedures and implementation of appropriate BMPs can minimize the impact that concrete-finishing methods may have on stormwater and non-stormwater discharges.

The General Permit incorporates Numeric Action Levels (NAL) for pH (see Section 2 of this handbook to determine your project's risk level and if you are subject to these requirements).

Concrete and its associated curing materials have basic chemical properties that can raise pH levels outside of the permitted range. Additional care should be taken when managing these materials to prevent them from coming into contact with stormwater flows, which could lead to exceedances of the General Permit requirements.

Suitable Applications

These procedures apply to all construction locations where concrete finishing operations are performed.



Limitations

- Runoff contact with concrete waste can raise pH levels in the water to environmentally harmful levels and trigger permit violations.

Implementation

- Collect and properly dispose of water from high-pressure water blasting operations.
- Collect contaminated water from blasting operations at the top of slopes. Transport or dispose of contaminated water while using BMPs such as those for erosion control. Refer to EC-9, Earth Dikes and Drainage Swales, EC-10, Velocity Dissipation Devices, and EC-11, Slope Drains.
- Direct water from blasting operations away from inlets and watercourses to collection areas for infiltration or other means of removal (dewatering). Refer to NS-2 Dewatering Operations.
- Protect inlets during sandblasting operations. Refer to SE-10, Storm Drain Inlet Protection.
- Refer to WM-8, Concrete Waste Management for disposal of concrete debris.
- Minimize the drift of dust and blast material as much as possible by keeping the blasting nozzle close to the surface.
- When blast residue contains a potentially hazardous waste, refer to WM-6, Hazardous Waste Management.

Education

- Educate employees, subcontractors, and suppliers on proper concrete finishing techniques to prevent contact with discharge as described herein.
- Arrange for the QSP or the appropriately trained contractor's superintendent or representative to oversee and enforce concrete finishing procedures.

Costs

These measures are generally of low cost.

Inspection and Maintenance

- Inspect and verify that activity-based BMPs are in place prior to the commencement of associated activities.
- BMPs must be inspected in accordance with General Permit requirements for the associated project type and risk level. It is recommended that at a minimum, BMPs be inspected weekly, prior to forecasted rain events, daily during extended rain events, and after the conclusion of rain events.
- Inspect BMPs subject to non-stormwater discharges daily while non-stormwater discharges occur.
- Sample non-stormwater discharges and stormwater runoff that contacts concrete dust and debris as required by the General Permit.

- Sweep or vacuum up debris from sandblasting at the end of each shift.
- At the end of each work shift, remove and contain liquid and solid waste from containment structures, if any, and from the general work area.
- Inspect containment structures for damage prior to use and prior to onset of forecasted rain.

References

Blueprint for a Clean Bay: Best Management Practices to Prevent Stormwater Pollution from Construction Related Activities; Santa Clara Valley Nonpoint Source Pollution Control Program, 1995.

Stormwater Quality Handbooks - Construction Site Best Management Practices (BMPs) Manual, State of California Department of Transportation (Caltrans), March 2003.

Stormwater Management for Construction Activities, Developing Pollution Prevention Plans and Best Management Practices, EPA 832-R-92005; USEPA, April 1992.

Material Delivery and Storage

WM-1

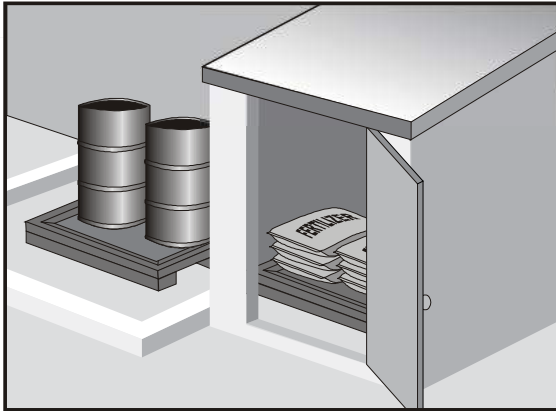

Description and Purpose

Prevent, reduce, or eliminate the discharge of pollutants from material delivery and storage to the stormwater system or watercourses by minimizing the storage of hazardous materials onsite, storing materials in watertight containers and/or a completely enclosed designated area, installing secondary containment, conducting regular inspections, and training employees and subcontractors.

This best management practice covers only material delivery and storage. For other information on materials, see WM-2, Material Use, or WM-4, Spill Prevention and Control. For information on wastes, see the waste management BMPs in this section.

Suitable Applications

These procedures are suitable for use at all construction sites with delivery and storage of the following materials:

- Soil stabilizers and binders
- Pesticides and herbicides
- Fertilizers
- Detergents
- Plaster
- Petroleum products such as fuel, oil, and grease

Categories

EC	Erosion Control	
SE	Sediment Control	
TC	Tracking Control	
WE	Wind Erosion Control	
NS	Non-Stormwater Management Control	
WM	Waste Management and Materials Pollution Control	<input checked="" type="checkbox"/>

Legend:

- Primary Category
- Secondary Category

Targeted Constituents

Sediment	<input checked="" type="checkbox"/>
Nutrients	<input checked="" type="checkbox"/>
Trash	<input checked="" type="checkbox"/>
Metals	<input checked="" type="checkbox"/>
Bacteria	
Oil and Grease	<input checked="" type="checkbox"/>
Organics	<input checked="" type="checkbox"/>

Potential Alternatives

None

If User/Subscriber modifies this fact sheet in any way, the CASQA name/logo and footer below must be removed from each page and not appear on the modified version.



Material Delivery and Storage

WM-1

- Asphalt and concrete components
- Hazardous chemicals such as acids, lime, glues, adhesives, paints, solvents, and curing compounds
- Concrete compounds
- Other materials that may be detrimental if released to the environment

Limitations

- Space limitation may preclude indoor storage.
- Storage sheds often must meet building and fire code requirements.

Implementation

The following steps should be taken to minimize risk:

- Chemicals must be stored in water tight containers with appropriate secondary containment or in a storage shed.
- When a material storage area is located on bare soil, the area should be lined and bermed.
- Use containment pallets or other practical and available solutions, such as storing materials within newly constructed buildings or garages, to meet material storage requirements.
- Stack erodible landscape material on pallets and cover when not in use.
- Contain all fertilizers and other landscape materials when not in use.
- Temporary storage areas should be located away from vehicular traffic.
- Material Safety Data Sheets (MSDS) should be available on-site for all materials stored that have the potential to effect water quality.
- Construction site areas should be designated for material delivery and storage.
- Material delivery and storage areas should be located away from waterways, if possible.
 - Avoid transport near drainage paths or waterways.
 - Surround with earth berms or other appropriate containment BMP. See EC-9, Earth Dikes and Drainage Swales.
 - Place in an area that will be paved.
- Storage of reactive, ignitable, or flammable liquids must comply with the fire codes of your area. Contact the local Fire Marshal to review site materials, quantities, and proposed storage area to determine specific requirements. See the Flammable and Combustible Liquid Code, NFPA30.
- An up to date inventory of materials delivered and stored onsite should be kept.

Material Delivery and Storage

WM-1

- Hazardous materials storage onsite should be minimized.
- Hazardous materials should be handled as infrequently as possible.
- Keep ample spill cleanup supplies appropriate for the materials being stored. Ensure that cleanup supplies are in a conspicuous, labeled area.
- Employees and subcontractors should be trained on the proper material delivery and storage practices.
- Employees trained in emergency spill cleanup procedures must be present when dangerous materials or liquid chemicals are unloaded.
- If significant residual materials remain on the ground after construction is complete, properly remove and dispose of materials and any contaminated soil. See WM-7, Contaminated Soil Management. If the area is to be paved, pave as soon as materials are removed to stabilize the soil.

Material Storage Areas and Practices

- Liquids, petroleum products, and substances listed in 40 CFR Parts 110, 117, or 302 should be stored in approved containers and drums and should not be overfilled. Containers and drums should be placed in temporary containment facilities for storage.
- A temporary containment facility should provide for a spill containment volume able to contain precipitation from a 25 year storm event, plus the greater of 10% of the aggregate volume of all containers or 100% of the capacity of the largest container within its boundary, whichever is greater.
- A temporary containment facility should be impervious to the materials stored therein for a minimum contact time of 72 hours.
- A temporary containment facility should be maintained free of accumulated rainwater and spills. In the event of spills or leaks, accumulated rainwater and spills should be collected and placed into drums. These liquids should be handled as a hazardous waste unless testing determines them to be non-hazardous. All collected liquids or non-hazardous liquids should be sent to an approved disposal site.
- Sufficient separation should be provided between stored containers to allow for spill cleanup and emergency response access.
- Incompatible materials, such as chlorine and ammonia, should not be stored in the same temporary containment facility.
- Materials should be covered prior to, and during rain events.
- Materials should be stored in their original containers and the original product labels should be maintained in place in a legible condition. Damaged or otherwise illegible labels should be replaced immediately.

Material Delivery and Storage

WM-1

- Bagged and boxed materials should be stored on pallets and should not be allowed to accumulate on the ground. To provide protection from wind and rain throughout the rainy season, bagged and boxed materials should be covered during non-working days and prior to and during rain events.
- Stockpiles should be protected in accordance with WM-3, Stockpile Management.
- Materials should be stored indoors within existing structures or completely enclosed storage sheds when available.
- Proper storage instructions should be posted at all times in an open and conspicuous location.
- An ample supply of appropriate spill clean up material should be kept near storage areas.
- Also see WM-6, Hazardous Waste Management, for storing of hazardous wastes.

Material Delivery Practices

- Keep an accurate, up-to-date inventory of material delivered and stored onsite.
- Arrange for employees trained in emergency spill cleanup procedures to be present when dangerous materials or liquid chemicals are unloaded.

Spill Cleanup

- Contain and clean up any spill immediately.
- Properly remove and dispose of any hazardous materials or contaminated soil if significant residual materials remain on the ground after construction is complete. See WM-7, Contaminated Soil Management.
- See WM-4, Spill Prevention and Control, for spills of chemicals and/or hazardous materials.
- If spills or leaks of materials occur that are not contained and could discharge to surface waters, non-visible sampling of site discharge may be required. Refer to the General Permit or to your project specific Construction Site Monitoring Plan to determine if and where sampling is required.

Cost

- The largest cost of implementation may be in the construction of a materials storage area that is covered and provides secondary containment.

Inspection and Maintenance

- BMPs must be inspected in accordance with General Permit requirements for the associated project type and risk level. It is recommended that at a minimum, BMPs be inspected weekly, prior to forecasted rain events, daily during extended rain events, and after the conclusion of rain events.
- Keep storage areas clean and well organized, including a current list of all materials onsite.
- Inspect labels on containers for legibility and accuracy.

Material Delivery and Storage

WM-1

- Repair or replace perimeter controls, containment structures, covers, and liners as needed to maintain proper function.

References

Blueprint for a Clean Bay: Best Management Practices to Prevent Stormwater Pollution from Construction Related Activities; Santa Clara Valley Nonpoint Source Pollution Control Program, 1995.

Coastal Nonpoint Pollution Control Program: Program Development and Approval Guidance, Working Group Working Paper; USEPA, April 1992.

Stormwater Quality Handbooks - Construction Site Best Management Practices (BMPs) Manual, State of California Department of Transportation (Caltrans), March 2003.

Stormwater Management for Construction Activities; Developing Pollution Prevention Plans and Best Management Practice, EPA 832-R-92005; USEPA, April 1992.

Material Use

WM-2

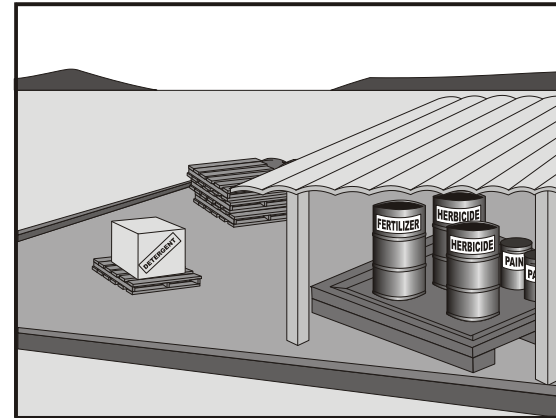

Description and Purpose

Prevent or reduce the discharge of pollutants to the storm drain system or watercourses from material use by using alternative products, minimizing hazardous material use onsite, and training employees and subcontractors.

Suitable Applications

This BMP is suitable for use at all construction projects. These procedures apply when the following materials are used or prepared onsite:

- Pesticides and herbicides
- Fertilizers
- Detergents
- Petroleum products such as fuel, oil, and grease
- Asphalt and other concrete components
- Other hazardous chemicals such as acids, lime, glues, adhesives, paints, solvents, and curing compounds
- Other materials that may be detrimental if released to the environment

Categories

EC	Erosion Control	
SE	Sediment Control	
TC	Tracking Control	
WE	Wind Erosion Control	
NS	Non-Stormwater Management Control	
WM	Waste Management and Materials Pollution Control	<input checked="" type="checkbox"/>

Legend:

- Primary Category
- Secondary Category

Targeted Constituents

Sediment	<input checked="" type="checkbox"/>
Nutrients	<input checked="" type="checkbox"/>
Trash	<input checked="" type="checkbox"/>
Metals	<input checked="" type="checkbox"/>
Bacteria	
Oil and Grease	<input checked="" type="checkbox"/>
Organics	<input checked="" type="checkbox"/>

Potential Alternatives

None

If User/Subscriber modifies this fact sheet in any way, the CASQA name/logo and footer below must be removed from each page and not appear on the modified version.



Limitations

Safer alternative building and construction products may not be available or suitable in every instance.

Implementation

The following steps should be taken to minimize risk:

- Minimize use of hazardous materials onsite.
- Follow manufacturer instructions regarding uses, protective equipment, ventilation, flammability, and mixing of chemicals.
- Train personnel who use pesticides. The California Department of Pesticide Regulation and county agricultural commissioners license pesticide dealers, certify pesticide applicators, and conduct onsite inspections.
- The preferred method of termiticide application is soil injection near the existing or proposed structure foundation/slab; however, if not feasible, soil drench application of termiticides should follow EPA label guidelines and the following recommendations (most of which are applicable to most pesticide applications):
 - Do not treat soil that is water-saturated or frozen.
 - Application shall not commence within 24-hours of a predicted precipitation event with a 40% or greater probability. Weather tracking must be performed on a daily basis prior to termiticide application and during the period of termiticide application.
 - Do not allow treatment chemicals to runoff from the target area. Apply proper quantity to prevent excess runoff. Provide containment for and divert stormwater from application areas using berms or diversion ditches during application.
 - Dry season: Do not apply within 10 feet of storm drains. Do not apply within 25 feet of aquatic habitats (such as, but not limited to, lakes; reservoirs; rivers; permanent streams; marshes or ponds; estuaries; and commercial fish farm ponds).
 - Wet season: Do not apply within 50 feet of storm drains or aquatic habitats (such as, but not limited to, lakes; reservoirs; rivers; permanent streams; marshes or ponds; estuaries; and commercial fish farm ponds) unless a vegetative buffer is present (if so, refer to dry season requirements).
 - Do not make on-grade applications when sustained wind speeds are above 10 mph (at application site) at nozzle end height.
 - Cover treatment site prior to a rain event in order to prevent run-off of the pesticide into non-target areas. The treated area should be limited to a size that can be backfilled and/or covered by the end of the work shift. Backfilling or covering of the treated area shall be done by the end of the same work shift in which the application is made.
 - The applicator must either cover the soil him/herself or provide written notification of the above requirement to the contractor on site and to the person commissioning the

application (if different than the contractor). If notice is provided to the contractor or the person commissioning the application, then they are responsible under the Federal Insecticide Fungicide, and Rodenticide Act (FIFRA) to ensure that: 1) if the concrete slab cannot be poured over the treated soil within 24 hours of application, the treated soil is covered with a waterproof covering (such as polyethylene sheeting), and 2) the treated soil is covered if precipitation is predicted to occur before the concrete slab is scheduled to be poured.

- Do not over-apply fertilizers, herbicides, and pesticides. Prepare only the amount needed. Follow the recommended usage instructions. Over-application is expensive and environmentally harmful. Unless on steep slopes, till fertilizers into the soil rather than hydraulic application. Apply surface dressings in several smaller applications, as opposed to one large application, to allow time for infiltration and to avoid excess material being carried offsite by runoff. Do not apply these chemicals before predicted rainfall.
- Train employees and subcontractors in proper material use.
- Supply Material Safety Data Sheets (MSDS) for all materials.
- Dispose of latex paint and paint cans, used brushes, rags, absorbent materials, and drop cloths, when thoroughly dry and are no longer hazardous, with other construction debris.
- Do not remove the original product label; it contains important safety and disposal information. Use the entire product before disposing of the container.
- Mix paint indoors or in a containment area. Never clean paintbrushes or rinse paint containers into a street, gutter, storm drain, or watercourse. Dispose of any paint thinners, residue, and sludge(s) that cannot be recycled, as hazardous waste.
- For water-based paint, clean brushes to the extent practicable, and rinse to a drain leading to a sanitary sewer where permitted, or contain for proper disposal off site. For oil-based paints, clean brushes to the extent practicable, and filter and reuse thinners and solvents.
- Use recycled and less hazardous products when practical. Recycle residual paints, solvents, non-treated lumber, and other materials.
- Use materials only where and when needed to complete the construction activity. Use safer alternative materials as much as possible. Reduce or eliminate use of hazardous materials onsite when practical.
- Document the location, time, chemicals applied, and applicator's name and qualifications.
- Keep an ample supply of spill clean up material near use areas. Train employees in spill clean up procedures.
- Avoid exposing applied materials to rainfall and runoff unless sufficient time has been allowed for them to dry.
- Discontinue use of erodible landscape material within 2 days prior to a forecasted rain event and materials should be covered and/or bermed.

Material Use

WM-2

- Provide containment for material use areas such as masons' areas or paint mixing/preparation areas to prevent materials/pollutants from entering stormwater.

Costs

All of the above are low cost measures.

Inspection and Maintenance

- Inspect and verify that activity-based BMPs are in place prior to the commencement of associated activities.
- BMPs must be inspected in accordance with General Permit requirements for the associated project type and risk level. It is recommended that at a minimum, BMPs be inspected weekly, prior to forecasted rain events, daily during extended rain events, and after the conclusion of rain events.
- Ensure employees and subcontractors throughout the job are using appropriate practices.

References

Blueprint for a Clean Bay: Best Management Practices to Prevent Stormwater Pollution from Construction Related Activities; Santa Clara Valley Nonpoint Source Pollution Control Program, 1995.

Coastal Nonpoint Pollution Control Program: Program Development and Approval Guidance, Working Group Working Paper; USEPA, April 1992.

Comments on Risk Assessments Risk Reduction Options for Cypermethrin: Docket No. OPP-2005-0293; California Stormwater Quality Association (CASQA) letter to USEPA, 2006. Environmental Hazard and General Labeling for Pyrethroid Non-Agricultural Outdoor Products, EPA-HQ-OPP-2008-0331-0021; USEPA, 2008.

Stormwater Quality Handbooks - Construction Site Best Management Practices (BMPs) Manual, State of California Department of Transportation (Caltrans), March 2003.

Stormwater Management for Construction Activities; Developing Pollution Prevention Plans and Best Management Practice, EPA 832-R-92005; USEPA, April 1992.

Stockpile Management

WM-3

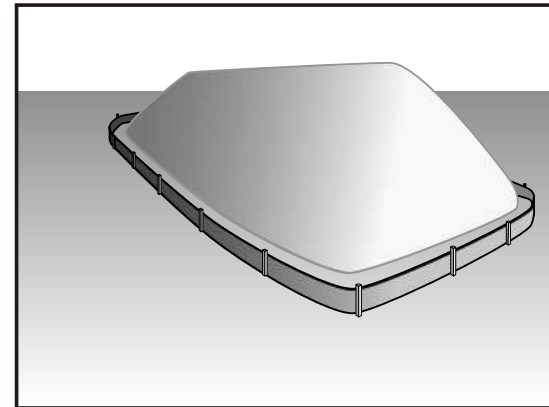

Categories

EC	Erosion Control	
SE	Sediment Control	<input checked="" type="checkbox"/>
TC	Tracking Control	
WE	Wind Erosion Control	
NS	Non-Stormwater Management Control	<input checked="" type="checkbox"/>
WM	Waste Management and Materials Pollution Control	<input checked="" type="checkbox"/>

Legend:

- Primary Category
- Secondary Category

Targeted Constituents

Sediment	<input checked="" type="checkbox"/>
Nutrients	<input checked="" type="checkbox"/>
Trash	<input checked="" type="checkbox"/>
Metals	<input checked="" type="checkbox"/>
Bacteria	
Oil and Grease	<input checked="" type="checkbox"/>
Organics	<input checked="" type="checkbox"/>

Potential Alternatives

None

Description and Purpose

Stockpile management procedures and practices are designed to reduce or eliminate air and stormwater pollution from stockpiles of soil, soil amendments, sand, paving materials such as portland cement concrete (PCC) rubble, asphalt concrete (AC), asphalt concrete rubble, aggregate base, aggregate sub base or pre-mixed aggregate, asphalt minder (so called "cold mix" asphalt), and pressure treated wood.

Suitable Applications

Implement in all projects that stockpile soil and other loose materials.

Limitations

- Plastic sheeting as a stockpile protection is temporary and hard to manage in windy conditions. Where plastic is used, consider use of plastic tarps with nylon reinforcement which may be more durable than standard sheeting.
- Plastic sheeting can increase runoff volume due to lack of infiltration and potentially cause perimeter control failure.
- Plastic sheeting breaks down faster in sunlight.
- The use of Plastic materials and photodegradable plastics should be avoided.

Implementation

Protection of stockpiles is a year-round requirement. To properly manage stockpiles:

If User/Subscriber modifies this fact sheet in any way, the CASQA name/logo and footer below must be removed from each page and not appear on the modified version.



- On larger sites, a minimum of 50 ft separation from concentrated flows of stormwater, drainage courses, and inlets is recommended.
- After 14 days of inactivity, a stockpile is non-active and requires further protection described below. All stockpiles are required to be protected as non-active stockpiles immediately if they are not scheduled to be used within 14 days.
- Protect all stockpiles from stormwater runoff using temporary perimeter sediment barriers such as compost berms (SE-13), temporary silt dikes (SE-12), fiber rolls (SE-5), silt fences (SE-1), sandbags (SE-8), gravel bags (SE-6), or biofilter bags (SE-14). Refer to the individual fact sheet for each of these controls for installation information.
- Implement wind erosion control practices as appropriate on all stockpiled material. For specific information, see WE-1, Wind Erosion Control.
- Manage stockpiles of contaminated soil in accordance with WM-7, Contaminated Soil Management.
- Place bagged materials on pallets and under cover.
- Ensure that stockpile coverings are installed securely to protect from wind and rain.
- Some plastic covers withstand weather and sunlight better than others. Select cover materials or methods based on anticipated duration of use.

Protection of Non-Active Stockpiles

A stockpile is considered non-active if it either is not used for 14 days or if it is scheduled not to be used for 14 days or more. Stockpiles need to be protected immediately if they are not scheduled to be used within 14 days. Non-active stockpiles of the identified materials should be protected as follows:

Soil stockpiles

- Soil stockpiles should be covered or protected with soil stabilization measures and a temporary perimeter sediment barrier at all times.
- Temporary vegetation should be considered for topsoil piles that will be stockpiled for extended periods.

Stockpiles of Portland cement concrete rubble, asphalt concrete, asphalt concrete rubble, aggregate base, or aggregate sub base

- Stockpiles should be covered and protected with a temporary perimeter sediment barrier at all times.

Stockpiles of "cold mix"

- Cold mix stockpiles should be placed on and covered with plastic sheeting or comparable material at all times and surrounded by a berm.

Stockpiles of fly ash, stucco, hydrated lime

- Stockpiles of materials that may raise the pH of runoff (i.e., basic materials) should be covered with plastic and surrounded by a berm.

Stockpiles/Storage of wood (Pressure treated with chromated copper arsenate or ammoniacal copper zinc arsenate)

- Treated wood should be covered with plastic sheeting or comparable material at all times and surrounded by a berm.

Protection of Active Stockpiles

A stockpile is active when it is being used or is scheduled to be used within 14 days of the previous use. Active stockpiles of the identified materials should be protected as follows:

- All stockpiles should be covered and protected with a temporary linear sediment barrier prior to the onset of precipitation.
- Stockpiles of "cold mix" and treated wood, and basic materials should be placed on and covered with plastic sheeting or comparable material and surrounded by a berm prior to the onset of precipitation.
- The downstream perimeter of an active stockpile should be protected with a linear sediment barrier or berm and runoff should be diverted around or away from the stockpile on the upstream perimeter.

Costs

For cost information associated with stockpile protection refer to the individual erosion or sediment control BMP fact sheet considered for implementation (For example, refer to SE-1 Silt Fence for installation of silt fence around the perimeter of a stockpile.)

Inspection and Maintenance

- Stockpiles must be inspected in accordance with General Permit requirements for the associated project type and risk level. It is recommended that at a minimum, BMPs be inspected weekly, prior to forecasted rain events, daily during extended rain events, and after the conclusion of rain events.
- It may be necessary to inspect stockpiles covered with plastic sheeting more frequently during certain conditions (for example, high winds or extreme heat).
- Repair and/or replace perimeter controls and covers as needed to keep them functioning properly.
- Sediment shall be removed when it reaches one-third of the barrier height.

References

Stormwater Quality Handbooks - Construction Site Best Management Practices (BMPs) Manual, State of California Department of Transportation (Caltrans), March 2003.

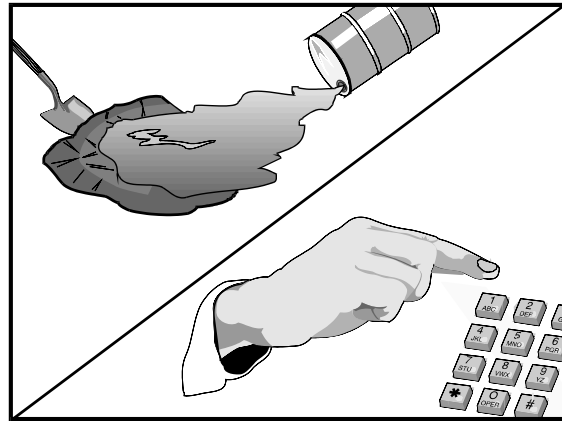

Description and Purpose

Prevent or reduce the discharge of pollutants to drainage systems or watercourses from leaks and spills by reducing the chance for spills, stopping the source of spills, containing and cleaning up spills, properly disposing of spill materials, and training employees.

This best management practice covers only spill prevention and control. However, WM-1, Materials Delivery and Storage, and WM-2, Material Use, also contain useful information, particularly on spill prevention. For information on wastes, see the waste management BMPs in this section.

Suitable Applications

This BMP is suitable for all construction projects. Spill control procedures are implemented anytime chemicals or hazardous substances are stored on the construction site, including the following materials:

- Soil stabilizers/binders
- Dust palliatives
- Herbicides
- Growth inhibitors
- Fertilizers
- Deicing/anti-icing chemicals

Categories

EC	Erosion Control	
SE	Sediment Control	
TC	Tracking Control	
WE	Wind Erosion Control	
NS	Non-Stormwater Management Control	
WM	Waste Management and Materials Pollution Control	<input checked="" type="checkbox"/>

Legend:

- Primary Objective
- Secondary Objective

Targeted Constituents

Sediment	<input checked="" type="checkbox"/>
Nutrients	<input checked="" type="checkbox"/>
Trash	<input checked="" type="checkbox"/>
Metals	<input checked="" type="checkbox"/>
Bacteria	
Oil and Grease	<input checked="" type="checkbox"/>
Organics	<input checked="" type="checkbox"/>

Potential Alternatives

None

If User/Subscriber modifies this fact sheet in any way, the CASQA name/logo and footer below must be removed from each page and not appear on the modified version.



- Fuels
- Lubricants
- Other petroleum distillates

Limitations

- In some cases it may be necessary to use a private spill cleanup company.
- This BMP applies to spills caused by the contractor and subcontractors.
- Procedures and practices presented in this BMP are general. Contractor should identify appropriate practices for the specific materials used or stored onsite

Implementation

The following steps will help reduce the stormwater impacts of leaks and spills:

Education

- Be aware that different materials pollute in different amounts. Make sure that each employee knows what a "significant spill" is for each material they use, and what is the appropriate response for "significant" and "insignificant" spills.
- Educate employees and subcontractors on potential dangers to humans and the environment from spills and leaks.
- Hold regular meetings to discuss and reinforce appropriate disposal procedures (incorporate into regular safety meetings).
- Establish a continuing education program to indoctrinate new employees.
- Have contractor's superintendent or representative oversee and enforce proper spill prevention and control measures.

General Measures

- To the extent that the work can be accomplished safely, spills of oil, petroleum products, substances listed under 40 CFR parts 110,117, and 302, and sanitary and septic wastes should be contained and cleaned up immediately.
- Store hazardous materials and wastes in covered containers and protect from vandalism.
- Place a stockpile of spill cleanup materials where it will be readily accessible.
- Train employees in spill prevention and cleanup.
- Designate responsible individuals to oversee and enforce control measures.
- Spills should be covered and protected from stormwater runoff during rainfall to the extent that it doesn't compromise clean up activities.
- Do not bury or wash spills with water.

- Store and dispose of used clean up materials, contaminated materials, and recovered spill material that is no longer suitable for the intended purpose in conformance with the provisions in applicable BMPs.
- Do not allow water used for cleaning and decontamination to enter storm drains or watercourses. Collect and dispose of contaminated water in accordance with WM-10, Liquid Waste Management.
- Contain water overflow or minor water spillage and do not allow it to discharge into drainage facilities or watercourses.
- Place proper storage, cleanup, and spill reporting instructions for hazardous materials stored or used on the project site in an open, conspicuous, and accessible location.
- Keep waste storage areas clean, well organized, and equipped with ample cleanup supplies as appropriate for the materials being stored. Perimeter controls, containment structures, covers, and liners should be repaired or replaced as needed to maintain proper function.

Cleanup

- Clean up leaks and spills immediately.
- Use a rag for small spills on paved surfaces, a damp mop for general cleanup, and absorbent material for larger spills. If the spilled material is hazardous, then the used cleanup materials are also hazardous and must be sent to either a certified laundry (rags) or disposed of as hazardous waste.
- Never hose down or bury dry material spills. Clean up as much of the material as possible and dispose of properly. See the waste management BMPs in this section for specific information.

Minor Spills

- Minor spills typically involve small quantities of oil, gasoline, paint, etc. which can be controlled by the first responder at the discovery of the spill.
- Use absorbent materials on small spills rather than hosing down or burying the spill.
- Absorbent materials should be promptly removed and disposed of properly.
- Follow the practice below for a minor spill:
 - Contain the spread of the spill.
 - Recover spilled materials.
 - Clean the contaminated area and properly dispose of contaminated materials.

Semi-Significant Spills

- Semi-significant spills still can be controlled by the first responder along with the aid of other personnel such as laborers and the foreman, etc. This response may require the cessation of all other activities.

- Spills should be cleaned up immediately:
 - Contain spread of the spill.
 - Notify the project foreman immediately.
 - If the spill occurs on paved or impermeable surfaces, clean up using "dry" methods (absorbent materials, cat litter and/or rags). Contain the spill by encircling with absorbent materials and do not let the spill spread widely.
 - If the spill occurs in dirt areas, immediately contain the spill by constructing an earthen dike. Dig up and properly dispose of contaminated soil.
 - If the spill occurs during rain, cover spill with tarps or other material to prevent contaminating runoff.

Significant/Hazardous Spills

- For significant or hazardous spills that cannot be controlled by personnel in the immediate vicinity, the following steps should be taken:
 - Notify the local emergency response by dialing 911. In addition to 911, the contractor will notify the proper county officials. It is the contractor's responsibility to have all emergency phone numbers at the construction site.
 - Notify the Governor's Office of Emergency Services Warning Center, (916) 845-8911.
 - For spills of federal reportable quantities, in conformance with the requirements in 40 CFR parts 110,119, and 302, the contractor should notify the National Response Center at (800) 424-8802.
 - Notification should first be made by telephone and followed up with a written report.
 - The services of a spills contractor or a Haz-Mat team should be obtained immediately. Construction personnel should not attempt to clean up until the appropriate and qualified staffs have arrived at the job site.
 - Other agencies which may need to be consulted include, but are not limited to, the Fire Department, the Public Works Department, the Coast Guard, the Highway Patrol, the City/County Police Department, Department of Toxic Substances, California Division of Oil and Gas, Cal/OSHA, etc.

Reporting

- Report significant spills to local agencies, such as the Fire Department; they can assist in cleanup.
- Federal regulations require that any significant oil spill into a water body or onto an adjoining shoreline be reported to the National Response Center (NRC) at 800-424-8802 (24 hours).

Use the following measures related to specific activities:

Vehicle and Equipment Maintenance

- If maintenance must occur onsite, use a designated area and a secondary containment, located away from drainage courses, to prevent the runoff of stormwater and the runoff of spills.
- Regularly inspect onsite vehicles and equipment for leaks and repair immediately
- Check incoming vehicles and equipment (including delivery trucks, and employee and subcontractor vehicles) for leaking oil and fluids. Do not allow leaking vehicles or equipment onsite.
- Always use secondary containment, such as a drain pan or drop cloth, to catch spills or leaks when removing or changing fluids.
- Place drip pans or absorbent materials under paving equipment when not in use.
- Use absorbent materials on small spills rather than hosing down or burying the spill. Remove the absorbent materials promptly and dispose of properly.
- Promptly transfer used fluids to the proper waste or recycling drums. Don't leave full drip pans or other open containers lying around
- Oil filters disposed of in trashcans or dumpsters can leak oil and pollute stormwater. Place the oil filter in a funnel over a waste oil-recycling drum to drain excess oil before disposal. Oil filters can also be recycled. Ask the oil supplier or recycler about recycling oil filters.
- Store cracked batteries in a non-leaking secondary container. Do this with all cracked batteries even if you think all the acid has drained out. If you drop a battery, treat it as if it is cracked. Put it into the containment area until you are sure it is not leaking.

Vehicle and Equipment Fueling

- If fueling must occur onsite, use designate areas, located away from drainage courses, to prevent the runoff of stormwater and the runoff of spills.
- Discourage "topping off" of fuel tanks.
- Always use secondary containment, such as a drain pan, when fueling to catch spills/ leaks.

Costs

Prevention of leaks and spills is inexpensive. Treatment and/ or disposal of contaminated soil or water can be quite expensive.

Inspection and Maintenance

- Inspect and verify that activity-based BMPs are in place prior to the commencement of associated activities. While activities associated with the BMP are under way, inspect BMPs in accordance with General Permit requirements for the associated project type and risk level. It is recommended that at a minimum, BMPs be inspected weekly, prior to forecasted rain events, daily during extended rain events, and after the conclusion of rain events.

- Inspect BMPs subject to non-stormwater discharge daily while non-stormwater discharges occur.
- Keep ample supplies of spill control and cleanup materials onsite, near storage, unloading, and maintenance areas.
- Update your spill prevention and control plan and stock cleanup materials as changes occur in the types of chemicals onsite.

References

Blueprint for a Clean Bay: Best Management Practices to Prevent Stormwater Pollution from Construction Related Activities; Santa Clara Valley Nonpoint Source Pollution Control Program, 1995.

Stormwater Quality Handbooks - Construction Site Best Management Practices (BMPs) Manual, State of California Department of Transportation (Caltrans), November 2000.

Stormwater Management for Construction Activities; Developing Pollution Prevention Plans and Best Management Practice, EPA 832-R-92005; USEPA, April 1992.

Solid Waste Management

WM-5

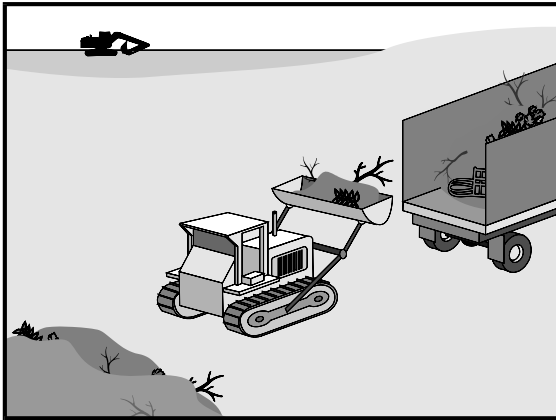

Description and Purpose

Solid waste management procedures and practices are designed to prevent or reduce the discharge of pollutants to stormwater from solid or construction waste by providing designated waste collection areas and containers, arranging for regular disposal, and training employees and subcontractors.

Suitable Applications

This BMP is suitable for construction sites where the following wastes are generated or stored:

- Solid waste generated from trees and shrubs removed during land clearing, demolition of existing structures (rubble), and building construction
- Packaging materials including wood, paper, and plastic
- Scrap or surplus building materials including scrap metals, rubber, plastic, glass pieces, and masonry products
- Domestic wastes including food containers such as beverage cans, coffee cups, paper bags, plastic wrappers, and cigarettes
- Construction wastes including brick, mortar, timber, steel and metal scraps, pipe and electrical cuttings, non-hazardous equipment parts, styrofoam and other materials used to transport and package construction materials

Categories

EC	Erosion Control	
SE	Sediment Control	
TC	Tracking Control	
WE	Wind Erosion Control	
NS	Non-Stormwater Management Control	
WM	Waste Management and Materials Pollution Control	<input checked="" type="checkbox"/>

Legend:

- Primary Objective
- Secondary Objective

Targeted Constituents

Sediment	<input checked="" type="checkbox"/>
Nutrients	<input checked="" type="checkbox"/>
Trash	<input checked="" type="checkbox"/>
Metals	<input checked="" type="checkbox"/>
Bacteria	
Oil and Grease	<input checked="" type="checkbox"/>
Organics	<input checked="" type="checkbox"/>

Potential Alternatives

None

If User/Subscriber modifies this fact sheet in any way, the CASQA name/logo and footer below must be removed from each page and not appear on the modified version.



Solid Waste Management

WM-5

- Highway planting wastes, including vegetative material, plant containers, and packaging materials

Limitations

Temporary stockpiling of certain construction wastes may not necessitate stringent drainage related controls during the non-rainy season or in desert areas with low rainfall.

Implementation

The following steps will help keep a clean site and reduce stormwater pollution:

- Select designated waste collection areas onsite.
- Inform trash-hauling contractors that you will accept only watertight dumpsters for onsite use. Inspect dumpsters for leaks and repair any dumpster that is not watertight.
- Locate containers in a covered area or in a secondary containment.
- Provide an adequate number of containers with lids or covers that can be placed over the container to keep rain out or to prevent loss of wastes when it is windy.
- Cover waste containers at the end of each work day and when it is raining.
- Plan for additional containers and more frequent pickup during the demolition phase of construction.
- Collect site trash daily, especially during rainy and windy conditions.
- Remove this solid waste promptly since erosion and sediment control devices tend to collect litter.
- Make sure that toxic liquid wastes (used oils, solvents, and paints) and chemicals (acids, pesticides, additives, curing compounds) are not disposed of in dumpsters designated for construction debris.
- Do not hose out dumpsters on the construction site. Leave dumpster cleaning to the trash hauling contractor.
- Arrange for regular waste collection before containers overflow.
- Clean up immediately if a container does spill.
- Make sure that construction waste is collected, removed, and disposed of only at authorized disposal areas.

Education

- Have the contractor's superintendent or representative oversee and enforce proper solid waste management procedures and practices.
- Instruct employees and subcontractors on identification of solid waste and hazardous waste.
- Educate employees and subcontractors on solid waste storage and disposal procedures.

- Hold regular meetings to discuss and reinforce disposal procedures (incorporate into regular safety meetings).
- Require that employees and subcontractors follow solid waste handling and storage procedures.
- Prohibit littering by employees, subcontractors, and visitors.
- Minimize production of solid waste materials wherever possible.

Collection, Storage, and Disposal

- Littering on the project site should be prohibited.
- To prevent clogging of the storm drainage system, litter and debris removal from drainage grates, trash racks, and ditch lines should be a priority.
- Trash receptacles should be provided in the contractor's yard, field trailer areas, and at locations where workers congregate for lunch and break periods.
- Litter from work areas within the construction limits of the project site should be collected and placed in watertight dumpsters at least weekly, regardless of whether the litter was generated by the contractor, the public, or others. Collected litter and debris should not be placed in or next to drain inlets, stormwater drainage systems, or watercourses.
- Dumpsters of sufficient size and number should be provided to contain the solid waste generated by the project.
- Full dumpsters should be removed from the project site and the contents should be disposed of by the trash hauling contractor.
- Construction debris and waste should be removed from the site biweekly or more frequently as needed.
- Construction material visible to the public should be stored or stacked in an orderly manner.
- Stormwater runoff should be prevented from contacting stored solid waste through the use of berms, dikes, or other temporary diversion structures or through the use of measures to elevate waste from site surfaces.
- Solid waste storage areas should be located at least 50 ft from drainage facilities and watercourses and should not be located in areas prone to flooding or ponding.
- Except during fair weather, construction and highway planting waste not stored in watertight dumpsters should be securely covered from wind and rain by covering the waste with tarps or plastic.
- Segregate potentially hazardous waste from non-hazardous construction site waste.
- Make sure that toxic liquid wastes (used oils, solvents, and paints) and chemicals (acids, pesticides, additives, curing compounds) are not disposed of in dumpsters designated for construction debris.

- For disposal of hazardous waste, see WM-6, Hazardous Waste Management. Have hazardous waste hauled to an appropriate disposal and/or recycling facility.
- Salvage or recycle useful vegetation debris, packaging and surplus building materials when practical. For example, trees and shrubs from land clearing can be used as a brush barrier, or converted into wood chips, then used as mulch on graded areas. Wood pallets, cardboard boxes, and construction scraps can also be recycled.

Costs

All of the above are low cost measures.

Inspection and Maintenance

- Inspect and verify that activity-based BMPs are in place prior to the commencement of associated activities. While activities associated with the BMP are under way, inspect BMPs in accordance with General Permit requirements for the associated project type and risk level. It is recommended that at a minimum, BMPs be inspected weekly, prior to forecasted rain events, daily during extended rain events, and after the conclusion of rain events.
- Inspect BMPs subject to non-stormwater discharge daily while non-stormwater discharges occur
- Inspect construction waste area regularly.
- Arrange for regular waste collection.

References

Processes, Procedures and Methods to Control Pollution Resulting from All Construction Activity, 430/9-73-007, USEPA, 1973.

Stormwater Quality Handbooks - Construction Site Best Management Practices (BMPs) Manual, State of California Department of Transportation (Caltrans), November 2000.

Stormwater Management for Construction Activities; Developing Pollution Prevention Plans and Best Management Practice, EPA 832-R-92005; USEPA, April 1992.

Hazardous Waste Management WM-6

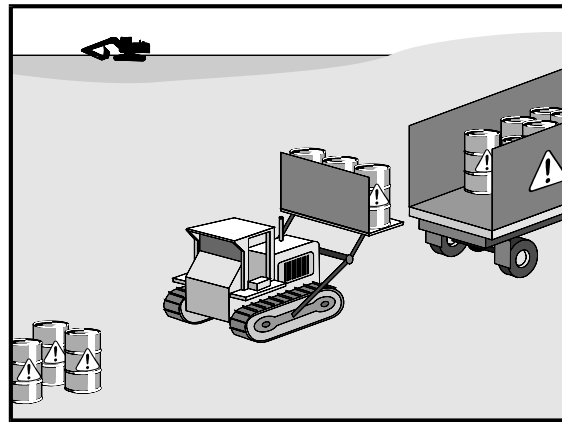

Description and Purpose

Prevent or reduce the discharge of pollutants to stormwater from hazardous waste through proper material use, waste disposal, and training of employees and subcontractors.

Suitable Applications

This best management practice (BMP) applies to all construction projects. Hazardous waste management practices are implemented on construction projects that generate waste from the use of:

- Petroleum Products
- Concrete Curing Compounds
- Palliatives
- Septic Wastes
- Stains
- Wood Preservatives
- Asphalt Products
- Pesticides
- Acids
- Paints
- Solvents
- Roofing Tar
- Any materials deemed a hazardous waste in California, Title 22 Division 4.5, or listed in 40 CFR Parts 110, 117, 261, or 302

Categories

EC	Erosion Control	
SE	Sediment Control	
TC	Tracking Control	
WE	Wind Erosion Control	
NS	Non-Stormwater Management Control	
WM	Waste Management and Materials Pollution Control	<input checked="" type="checkbox"/>

Legend:

- Primary Objective
- Secondary Objective

Targeted Constituents

Sediment	<input type="checkbox"/>
Nutrients	<input type="checkbox"/>
Trash	<input checked="" type="checkbox"/>
Metals	<input checked="" type="checkbox"/>
Bacteria	<input checked="" type="checkbox"/>
Oil and Grease	<input checked="" type="checkbox"/>
Organics	<input checked="" type="checkbox"/>

Potential Alternatives

None

If User/Subscriber modifies this fact sheet in any way, the CASQA name/logo and footer below must be removed from each page and not appear on the modified version.



Hazardous Waste Management WM-6

In addition, sites with existing structures may contain wastes, which must be disposed of in accordance with federal, state, and local regulations. These wastes include:

- Sandblasting grit mixed with lead-, cadmium-, or chromium-based paints
- Asbestos
- PCBs (particularly in older transformers)

Limitations

- Hazardous waste that cannot be reused or recycled must be disposed of by a licensed hazardous waste hauler.
- Nothing in this BMP relieves the contractor from responsibility for compliance with federal, state, and local laws regarding storage, handling, transportation, and disposal of hazardous wastes.
- This BMP does not cover aerielly deposited lead (ADL) soils. For ADL soils refer to WM-7, Contaminated Soil Management.

Implementation

The following steps will help reduce stormwater pollution from hazardous wastes:

Material Use

- Wastes should be stored in sealed containers constructed of a suitable material and should be labeled as required by Title 22 CCR, Division 4.5 and 49 CFR Parts 172, 173, 178, and 179.
- All hazardous waste should be stored, transported, and disposed as required in Title 22 CCR, Division 4.5 and 49 CFR 261-263.
- Waste containers should be stored in temporary containment facilities that should comply with the following requirements:
 - Temporary containment facility should provide for a spill containment volume equal to 1.5 times the volume of all containers able to contain precipitation from a 25 year storm event, plus the greater of 10% of the aggregate volume of all containers or 100% of the capacity of the largest tank within its boundary, whichever is greater.
 - Temporary containment facility should be impervious to the materials stored there for a minimum contact time of 72 hours.
 - Temporary containment facilities should be maintained free of accumulated rainwater and spills. In the event of spills or leaks, accumulated rainwater and spills should be placed into drums after each rainfall. These liquids should be handled as a hazardous waste unless testing determines them to be non-hazardous. Non-hazardous liquids should be sent to an approved disposal site.
 - Sufficient separation should be provided between stored containers to allow for spill cleanup and emergency response access.

Hazardous Waste Management WM-6

- Incompatible materials, such as chlorine and ammonia, should not be stored in the same temporary containment facility.
- Throughout the rainy season, temporary containment facilities should be covered during non-working days, and prior to rain events. Covered facilities may include use of plastic tarps for small facilities or constructed roofs with overhangs.
- Drums should not be overfilled and wastes should not be mixed.
- Unless watertight, containers of dry waste should be stored on pallets.
- Do not over-apply herbicides and pesticides. Prepare only the amount needed. Follow the recommended usage instructions. Over application is expensive and environmentally harmful. Apply surface dressings in several smaller applications, as opposed to one large application. Allow time for infiltration and avoid excess material being carried offsite by runoff. Do not apply these chemicals just before it rains. People applying pesticides must be certified in accordance with federal and state regulations.
- Paint brushes and equipment for water and oil based paints should be cleaned within a contained area and should not be allowed to contaminate site soils, watercourses, or drainage systems. Waste paints, thinners, solvents, residues, and sludges that cannot be recycled or reused should be disposed of as hazardous waste. When thoroughly dry, latex paint and paint cans, used brushes, rags, absorbent materials, and drop cloths should be disposed of as solid waste.
- Do not clean out brushes or rinse paint containers into the dirt, street, gutter, storm drain, or stream. "Paint out" brushes as much as possible. Rinse water-based paints to the sanitary sewer. Filter and reuse thinners and solvents. Dispose of excess oil-based paints and sludge as hazardous waste.
- The following actions should be taken with respect to temporary contaminant:
 - Ensure that adequate hazardous waste storage volume is available.
 - Ensure that hazardous waste collection containers are conveniently located.
 - Designate hazardous waste storage areas onsite away from storm drains or watercourses and away from moving vehicles and equipment to prevent accidental spills.
 - Minimize production or generation of hazardous materials and hazardous waste on the job site.
 - Use containment berms in fueling and maintenance areas and where the potential for spills is high.
 - Segregate potentially hazardous waste from non-hazardous construction site debris.
 - Keep liquid or semi-liquid hazardous waste in appropriate containers (closed drums or similar) and under cover.

Hazardous Waste Management WM-6

- Clearly label all hazardous waste containers with the waste being stored and the date of accumulation.
- Place hazardous waste containers in secondary containment.
- Do not allow potentially hazardous waste materials to accumulate on the ground.
- Do not mix wastes.
- Use all of the product before disposing of the container.
- Do not remove the original product label; it contains important safety and disposal information.

Waste Recycling Disposal

- Select designated hazardous waste collection areas onsite.
- Hazardous materials and wastes should be stored in covered containers and protected from vandalism.
- Place hazardous waste containers in secondary containment.
- Do not mix wastes, this can cause chemical reactions, making recycling impossible and complicating disposal.
- Recycle any useful materials such as used oil or water-based paint.
- Make sure that toxic liquid wastes (used oils, solvents, and paints) and chemicals (acids, pesticides, additives, curing compounds) are not disposed of in dumpsters designated for construction debris.
- Arrange for regular waste collection before containers overflow.
- Make sure that hazardous waste (e.g., excess oil-based paint and sludge) is collected, removed, and disposed of only at authorized disposal areas.

Disposal Procedures

- Waste should be disposed of by a licensed hazardous waste transporter at an authorized and licensed disposal facility or recycling facility utilizing properly completed Uniform Hazardous Waste Manifest forms.
- A Department of Health Services certified laboratory should sample waste to determine the appropriate disposal facility.
- Properly dispose of rainwater in secondary containment that may have mixed with hazardous waste.
- Attention is directed to "Hazardous Material", "Contaminated Material", and "Aerially Deposited Lead" of the contract documents regarding the handling and disposal of hazardous materials.

Hazardous Waste Management WM-6

Education

- Educate employees and subcontractors on hazardous waste storage and disposal procedures.
- Educate employees and subcontractors on potential dangers to humans and the environment from hazardous wastes.
- Instruct employees and subcontractors on safety procedures for common construction site hazardous wastes.
- Instruct employees and subcontractors in identification of hazardous and solid waste.
- Hold regular meetings to discuss and reinforce hazardous waste management procedures (incorporate into regular safety meetings).
- The contractor's superintendent or representative should oversee and enforce proper hazardous waste management procedures and practices.
- Make sure that hazardous waste is collected, removed, and disposed of only at authorized disposal areas.
- Warning signs should be placed in areas recently treated with chemicals.
- Place a stockpile of spill cleanup materials where it will be readily accessible.
- If a container does spill, clean up immediately.

Costs

All of the above are low cost measures.

Inspection and Maintenance

- Inspect and verify that activity-based BMPs are in place prior to the commencement of associated activities. While activities associated with the BMP are under way, inspect BMPs in accordance with General Permit requirements for the associated project type and risk level. It is recommended that at a minimum, BMPs be inspected weekly, prior to forecasted rain events, daily during extended rain events, and after the conclusion of rain events..
- Inspect BMPs subject to non-stormwater discharge daily while non-stormwater discharges occur
- Hazardous waste should be regularly collected.
- A foreman or construction supervisor should monitor onsite hazardous waste storage and disposal procedures.
- Waste storage areas should be kept clean, well organized, and equipped with ample cleanup supplies as appropriate for the materials being stored.
- Perimeter controls, containment structures, covers, and liners should be repaired or replaced as needed to maintain proper function.

Hazardous Waste Management WM-6

- Hazardous spills should be cleaned up and reported in conformance with the applicable Material Safety Data Sheet (MSDS) and the instructions posted at the project site.
- The National Response Center, at (800) 424-8802, should be notified of spills of federal reportable quantities in conformance with the requirements in 40 CFR parts 110, 117, and 302. Also notify the Governors Office of Emergency Services Warning Center at (916) 845-8911.
- A copy of the hazardous waste manifests should be provided.

References

Blueprint for a Clean Bay: Best Management Practices to Prevent Stormwater Pollution from Construction Related Activities; Santa Clara Valley Nonpoint Source Pollution Control Program, 1995.

Processes, Procedures and Methods to Control Pollution Resulting from All Construction Activity, 430/9-73-007, USEPA, 1973.

Stormwater Quality Handbooks - Construction Site Best Management Practices (BMPs) Manual, State of California Department of Transportation (Caltrans), November 2000.

Stormwater Management for Construction Activities; Developing Pollution Prevention Plans and Best Management Practice, EPA 832-R-92005; USEPA, April 1992.

Contaminated Soil Management WM-7

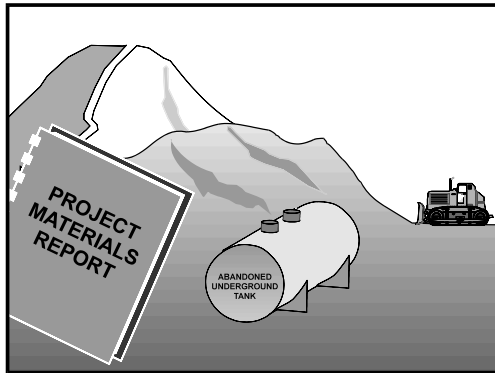

Description and Purpose

Prevent or reduce the discharge of pollutants to stormwater from contaminated soil and highly acidic or alkaline soils by conducting pre-construction surveys, inspecting excavations regularly, and remediating contaminated soil promptly.

Suitable Applications

Contaminated soil management is implemented on construction projects in highly urbanized or industrial areas where soil contamination may have occurred due to spills, illicit discharges, aerial deposition, past use and leaks from underground storage tanks.

Limitations

Contaminated soils that cannot be treated onsite must be disposed of offsite by a licensed hazardous waste hauler. The presence of contaminated soil may indicate contaminated water as well. See NS-2, Dewatering Operations, for more information.

The procedures and practices presented in this BMP are general. The contractor should identify appropriate practices and procedures for the specific contaminants known to exist or discovered onsite.

Implementation

Most owners and developers conduct pre-construction environmental assessments as a matter of routine. Contaminated soils are often identified during project planning and development with known locations identified in the plans, specifications and in the SWPPP. The contractor should review applicable reports and investigate appropriate call-outs in the

Categories

EC	Erosion Control	
SE	Sediment Control	
TC	Tracking Control	
WE	Wind Erosion Control	
NS	Non-Stormwater Management Control	
WM	Waste Management and Materials Pollution Control	<input checked="" type="checkbox"/>

Legend:

- Primary Objective
- Secondary Objective

Targeted Constituents

Sediment	
Nutrients	<input checked="" type="checkbox"/>
Trash	<input checked="" type="checkbox"/>
Metals	<input checked="" type="checkbox"/>
Bacteria	<input checked="" type="checkbox"/>
Oil and Grease	<input checked="" type="checkbox"/>
Organics	<input checked="" type="checkbox"/>

Potential Alternatives

None

If User/Subscriber modifies this fact sheet in any way, the CASQA name/logo and footer below must be removed from each page and not appear on the modified version.



Contaminated Soil Management WM-7

plans, specifications, and SWPPP. Recent court rulings holding contractors liable for cleanup costs when they unknowingly move contaminated soil highlight the need for contractors to confirm a site assessment is completed before earth moving begins.

The following steps will help reduce stormwater pollution from contaminated soil:

- Conduct thorough, pre-construction inspections of the site and review documents related to the site. If inspection or reviews indicated presence of contaminated soils, develop a plan before starting work.
- Look for contaminated soil as evidenced by discoloration, odors, differences in soil properties, abandoned underground tanks or pipes, or buried debris.
- Prevent leaks and spills. Contaminated soil can be expensive to treat and dispose of properly. However, addressing the problem before construction is much less expensive than after the structures are in place.
- The contractor may further identify contaminated soils by investigating:
 - Past site uses and activities
 - Detected or undetected spills and leaks
 - Acid or alkaline solutions from exposed soil or rock formations high in acid or alkaline forming elements
 - Contaminated soil as evidenced by discoloration, odors, differences in soil properties, abandoned underground tanks or pipes, or buried debris.
 - Suspected soils should be tested at a certified laboratory.

Education

- Have employees and subcontractors complete a safety training program which meets 29 CFR 1910.120 and 8 CCR 5192 covering the potential hazards as identified, prior to performing any excavation work at the locations containing material classified as hazardous.
- Educate employees and subcontractors in identification of contaminated soil and on contaminated soil handling and disposal procedures.
- Hold regular meetings to discuss and reinforce disposal procedures (incorporate into regular safety meetings).

Handling Procedures for Material with Aerially Deposited Lead (ADL)

- Materials from areas designated as containing (ADL) may, if allowed by the contract special provisions, be excavated, transported, and used in the construction of embankments and/or backfill.
- Excavation, transportation, and placement operations should result in no visible dust.
- Caution should be exercised to prevent spillage of lead containing material during transport.

Contaminated Soil Management WM-7

- Quality should be monitored during excavation of soils contaminated with lead.

Handling Procedures for Contaminated Soils

- Minimize onsite storage. Contaminated soil should be disposed of properly in accordance with all applicable regulations. All hazardous waste storage will comply with the requirements in Title 22, CCR, Sections 66265.250 to 66265.260.
- Test suspected soils at an approved certified laboratory.
- Work with the local regulatory agencies to develop options for treatment or disposal if the soil is contaminated.
- Avoid temporary stockpiling of contaminated soils or hazardous material.
- Take the following precautions if temporary stockpiling is necessary:
 - Cover the stockpile with plastic sheeting or tarps.
 - Install a berm around the stockpile to prevent runoff from leaving the area.
 - Do not stockpile in or near storm drains or watercourses.
- Remove contaminated material and hazardous material on exteriors of transport vehicles and place either into the current transport vehicle or into the excavation prior to the vehicle leaving the exclusion zone.
- Monitor the air quality continuously during excavation operations at all locations containing hazardous material.
- Procure all permits and licenses, pay all charges and fees, and give all notices necessary and incident to the due and lawful prosecution of the work, including registration for transporting vehicles carrying the contaminated material and the hazardous material.
- Collect water from decontamination procedures and treat or dispose of it at an appropriate disposal site.
- Collect non-reusable protective equipment, once used by any personnel, and dispose of at an appropriate disposal site.
- Install temporary security fence to surround and secure the exclusion zone. Remove fencing when no longer needed.
- Excavate, transport, and dispose of contaminated material and hazardous material in accordance with the rules and regulations of the following agencies (the specifications of these agencies supersede the procedures outlined in this BMP):
 - United States Department of Transportation (USDOT)
 - United States Environmental Protection Agency (USEPA)
 - California Environmental Protection Agency (CAL-EPA)

Contaminated Soil Management WM-7

- California Division of Occupation Safety and Health Administration (CAL-OSHA)
- Local regulatory agencies

Procedures for Underground Storage Tank Removals

- Prior to commencing tank removal operations, obtain the required underground storage tank removal permits and approval from the federal, state, and local agencies that have jurisdiction over such work.
- To determine if it contains hazardous substances, arrange to have tested, any liquid or sludge found in the underground tank prior to its removal.
- Following the tank removal, take soil samples beneath the excavated tank and perform analysis as required by the local agency representative(s).
- The underground storage tank, any liquid or sludge found within the tank, and all contaminated substances and hazardous substances removed during the tank removal and transported to disposal facilities permitted to accept such waste.

Water Control

- All necessary precautions and preventive measures should be taken to prevent the flow of water, including ground water, from mixing with hazardous substances or underground storage tank excavations. Such preventative measures may consist of, but are not limited to, berms, cofferdams, grout curtains, freeze walls, and seal course concrete or any combination thereof.
- If water does enter an excavation and becomes contaminated, such water, when necessary to proceed with the work, should be discharged to clean, closed top, watertight transportable holding tanks, treated, and disposed of in accordance with federal, state, and local laws.

Costs

Prevention of leaks and spills is inexpensive. Treatment or disposal of contaminated soil can be quite expensive.

Inspection and Maintenance

- Inspect and verify that activity-based BMPs are in place prior to the commencement of associated activities. While activities associated with the BMP are under way, inspect BMPs in accordance with General Permit requirements for the associated project type and risk level. It is recommended that at a minimum, BMPs be inspected weekly, prior to forecasted rain events, daily during extended rain events, and after the conclusion of rain events.
- Arrange for contractor's Water Pollution Control Manager, foreman, and/or construction supervisor to monitor onsite contaminated soil storage and disposal procedures.
- Monitor air quality continuously during excavation operations at all locations containing hazardous material.
- Coordinate contaminated soils and hazardous substances/waste management with the appropriate federal, state, and local agencies.

Contaminated Soil Management WM-7

- Implement WM-4, Spill Prevention and Control, to prevent leaks and spills as much as possible.

References

Blueprint for a Clean Bay: Best Management Practices to Prevent Stormwater Pollution from Construction Related Activities; Santa Clara Valley Nonpoint Source Pollution Control Program, 1995.

Processes, Procedures and Methods to Control Pollution Resulting from All Construction Activity, 430/9-73-007, USEPA, 1973.

Stormwater Quality Handbooks - Construction Site Best Management Practices (BMPs) Manual, State of California Department of Transportation (Caltrans), November 2000.

Stormwater Management for Construction Activities; Developing Pollution Prevention Plans and Best Management Practice, EPA 832-R-92005; USEPA, April 1992.

Concrete Waste Management WM-8

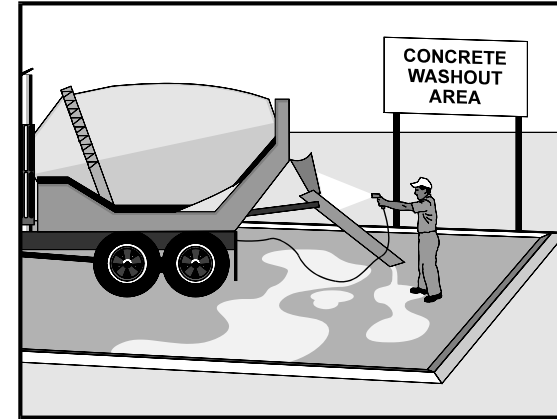

Description and Purpose

Prevent the discharge of pollutants to stormwater from concrete waste by conducting washout onsite or offsite in a designated area, and by employee and subcontractor training.

The General Permit incorporates Numeric Action Levels (NAL) for pH (see Section 2 of this handbook to determine your project's risk level and if you are subject to these requirements).

Many types of construction materials, including mortar, concrete, stucco, cement and block and their associated wastes have basic chemical properties that can raise pH levels outside of the permitted range. Additional care should be taken when managing these materials to prevent them from coming into contact with stormwater flows and raising pH to levels outside the accepted range.

Suitable Applications

Concrete waste management procedures and practices are implemented on construction projects where:

- Concrete is used as a construction material or where concrete dust and debris result from demolition activities.
- Slurries containing portland cement concrete (PCC) are generated, such as from saw cutting, coring, grinding, grooving, and hydro-concrete demolition.
- Concrete trucks and other concrete-coated equipment are washed onsite.

Categories

EC	Erosion Control	
SE	Sediment Control	
TC	Tracking Control	
WE	Wind Erosion Control	
NS	Non-Stormwater Management Control	<input checked="" type="checkbox"/>
WM	Waste Management and Materials Pollution Control	<input checked="" type="checkbox"/>

Legend:

- Primary Category
- Secondary Category

Targeted Constituents

Sediment	<input checked="" type="checkbox"/>
Nutrients	
Trash	
Metals	<input checked="" type="checkbox"/>
Bacteria	
Oil and Grease	
Organics	

Potential Alternatives

None

If User/Subscriber modifies this fact sheet in any way, the CASQA name/logo and footer below must be removed from each page and not appear on the modified version.



- Mortar-mixing stations exist.
- Stucco mixing and spraying.
- See also NS-8, Vehicle and Equipment Cleaning.

Limitations

- Offsite washout of concrete wastes may not always be possible.
- Multiple washouts may be needed to assure adequate capacity and to allow for evaporation.

Implementation

The following steps will help reduce stormwater pollution from concrete wastes:

- Incorporate requirements for concrete waste management into material supplier and subcontractor agreements.
- Store dry and wet materials under cover, away from drainage areas. Refer to WM-1, Material Delivery and Storage for more information.
- Avoid mixing excess amounts of concrete.
- Perform washout of concrete trucks in designated areas only, where washout will not reach stormwater.
- Do not wash out concrete trucks into storm drains, open ditches, streets, streams or onto the ground. Trucks should always be washed out into designated facilities.
- Do not allow excess concrete to be dumped onsite, except in designated areas.
- For onsite washout:
 - On larger sites, it is recommended to locate washout areas at least 50 feet from storm drains, open ditches, or water bodies. Do not allow runoff from this area by constructing a temporary pit or bermed area large enough for liquid and solid waste.
 - Washout wastes into the temporary washout where the concrete can set, be broken up, and then disposed properly.
 - Washouts shall be implemented in a manner that prevents leaching to underlying soils. Washout containers must be water tight and washouts on or in the ground must be lined with a suitable impervious liner, typically a plastic type material.
- Do not wash sweepings from exposed aggregate concrete into the street or storm drain. Collect and return sweepings to aggregate base stockpile or dispose in the trash.
- See typical concrete washout installation details at the end of this fact sheet.

Education

- Educate employees, subcontractors, and suppliers on the concrete waste management techniques described herein.

- Arrange for contractor's superintendent or representative to oversee and enforce concrete waste management procedures.
- Discuss the concrete management techniques described in this BMP (such as handling of concrete waste and washout) with the ready-mix concrete supplier before any deliveries are made.

Concrete Demolition Wastes

- Stockpile concrete demolition waste in accordance with BMP WM-3, Stockpile Management.
- Dispose of or recycle hardened concrete waste in accordance with applicable federal, state or local regulations.

Concrete Slurry Wastes

- PCC and AC waste should not be allowed to enter storm drains or watercourses.
- PCC and AC waste should be collected and disposed of or placed in a temporary concrete washout facility (as described in Onsite Temporary Concrete Washout Facility, Concrete Transit Truck Washout Procedures, below).
- A foreman or construction supervisor should monitor onsite concrete working tasks, such as saw cutting, coring, grinding and grooving to ensure proper methods are implemented.
- Saw-cut concrete slurry should not be allowed to enter storm drains or watercourses. Residue from grinding operations should be picked up by means of a vacuum attachment to the grinding machine or by sweeping. Saw cutting residue should not be allowed to flow across the pavement and should not be left on the surface of the pavement. See also NS-3, Paving and Grinding Operations; and WM-10, Liquid Waste Management.
- Concrete slurry residue should be disposed in a temporary washout facility (as described in Onsite Temporary Concrete Washout Facility, Concrete Transit Truck Washout Procedures, below) and allowed to dry. Dispose of dry slurry residue in accordance with WM-5, Solid Waste Management.

Onsite Temporary Concrete Washout Facility, Transit Truck Washout Procedures

- Temporary concrete washout facilities should be located a minimum of 50 ft from storm drain inlets, open drainage facilities, and watercourses. Each facility should be located away from construction traffic or access areas to prevent disturbance or tracking.
- A sign should be installed adjacent to each washout facility to inform concrete equipment operators to utilize the proper facilities.
- Temporary concrete washout facilities should be constructed above grade or below grade at the option of the contractor. Temporary concrete washout facilities should be constructed and maintained in sufficient quantity and size to contain all liquid and concrete waste generated by washout operations.

- Temporary washout facilities should have a temporary pit or bermed areas of sufficient volume to completely contain all liquid and waste concrete materials generated during washout procedures.
- Temporary washout facilities should be lined to prevent discharge to the underlying ground or surrounding area.
- Washout of concrete trucks should be performed in designated areas only.
- Only concrete from mixer truck chutes should be washed into concrete wash out.
- Concrete washout from concrete pumper bins can be washed into concrete pumper trucks and discharged into designated washout area or properly disposed of or recycled offsite.
- Once concrete wastes are washed into the designated area and allowed to harden, the concrete should be broken up, removed, and disposed of per WM-5, Solid Waste Management. Dispose of or recycle hardened concrete on a regular basis.
- Temporary Concrete Washout Facility (Type Above Grade)
 - Temporary concrete washout facility (type above grade) should be constructed as shown on the details at the end of this BMP, with a recommended minimum length and minimum width of 10 ft; however, smaller sites or jobs may only need a smaller washout facility. With any washout, always maintain a sufficient quantity and volume to contain all liquid and concrete waste generated by washout operations.
 - Materials used to construct the washout area should conform to the provisions detailed in their respective BMPs (e.g., SE-8 Sandbag Barrier).
 - Plastic lining material should be a minimum of 10 mil in polyethylene sheeting and should be free of holes, tears, or other defects that compromise the impermeability of the material.
 - Alternatively, portable removable containers can be used as above grade concrete washouts. Also called a "roll-off"; this concrete washout facility should be properly sealed to prevent leakage, and should be removed from the site and replaced when the container reaches 75% capacity.
- Temporary Concrete Washout Facility (Type Below Grade)
 - Temporary concrete washout facilities (type below grade) should be constructed as shown on the details at the end of this BMP, with a recommended minimum length and minimum width of 10 ft. The quantity and volume should be sufficient to contain all liquid and concrete waste generated by washout operations.
 - Lath and flagging should be commercial type.
 - Plastic lining material should be a minimum of 10 mil polyethylene sheeting and should be free of holes, tears, or other defects that compromise the impermeability of the material.

- The base of a washout facility should be free of rock or debris that may damage a plastic liner.

Removal of Temporary Concrete Washout Facilities

- When temporary concrete washout facilities are no longer required for the work, the hardened concrete should be removed and properly disposed or recycled in accordance with federal, state or local regulations. Materials used to construct temporary concrete washout facilities should be removed from the site of the work and properly disposed or recycled in accordance with federal, state or local regulations..
- Holes, depressions or other ground disturbance caused by the removal of the temporary concrete washout facilities should be backfilled and repaired.

Costs

All of the above are low cost measures. Roll-Off concrete washout facilities can be more costly than other measures due to removal and replacement; however, provide a cleaner alternative to traditional washouts. The type of washout facility, size, and availability of materials will determine the cost of the washout.

Inspection and Maintenance

- BMPs must be inspected in accordance with General Permit requirements for the associated project type and risk level. It is recommended that at a minimum, BMPs be inspected weekly, prior to forecasted rain events, daily during extended rain events, and after the conclusion of rain events.
- Temporary concrete washout facilities should be maintained to provide adequate holding capacity with a minimum freeboard of 4 in. for above grade facilities and 12 in. for below grade facilities. Maintaining temporary concrete washout facilities should include removing and disposing of hardened concrete and returning the facilities to a functional condition. Hardened concrete materials should be removed and properly disposed or recycled in accordance with federal, state or local regulations.
- Washout facilities must be cleaned, or new facilities must be constructed and ready for use once the washout is 75% full.
- Inspect washout facilities for damage (e.g. torn liner, evidence of leaks, signage, etc.). Repair all identified damage.

References

Blueprint for a Clean Bay: Best Management Practices to Prevent Stormwater Pollution from Construction Related Activities; Santa Clara Valley Nonpoint Source Pollution Control Program, 1995.

Stormwater Quality Handbooks - Construction Site Best Management Practices (BMPs) Manual, State of California Department of Transportation (Caltrans), November 2000, Updated March 2003.

Stormwater Management for Construction Activities; Developing Pollution Prevention Plans and Best Management Practice, EPA 832-R-92005; USEPA, April 1992.

Concrete Waste Management

WM-8

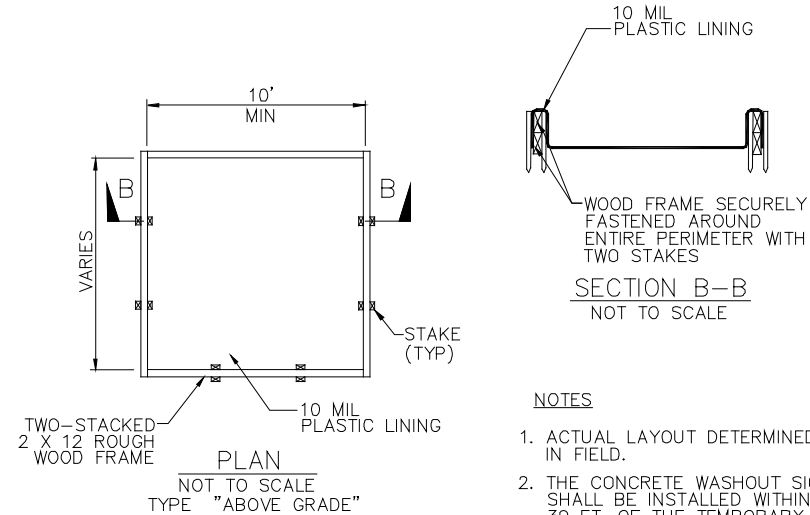
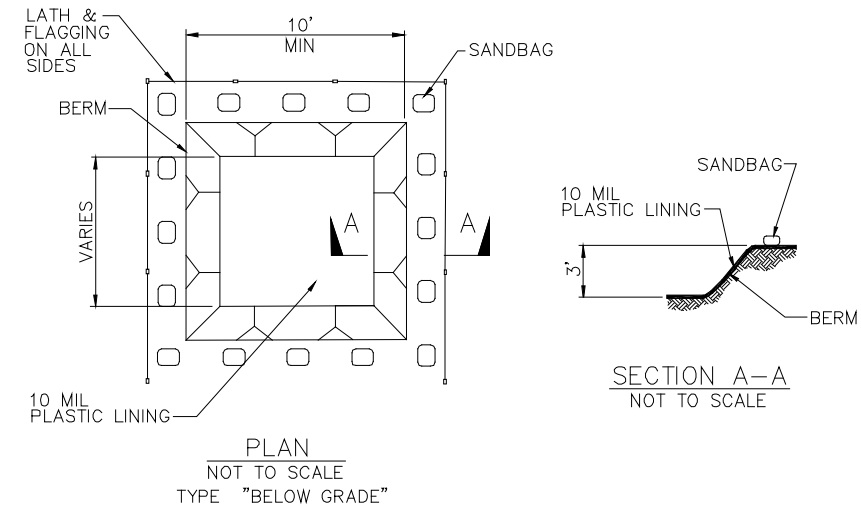

NOTES

1. ACTUAL LAYOUT DETERMINED IN FIELD.
2. THE CONCRETE WASHOUT SIGN SHALL BE INSTALLED WITHIN 30 FT. OF THE TEMPORARY CONCRETE WASHOUT FACILITY.

Concrete Waste Management

WM-8

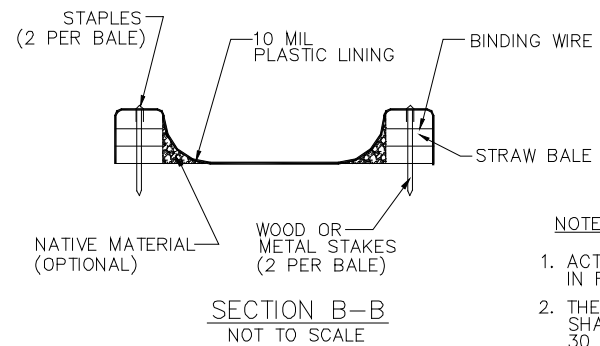
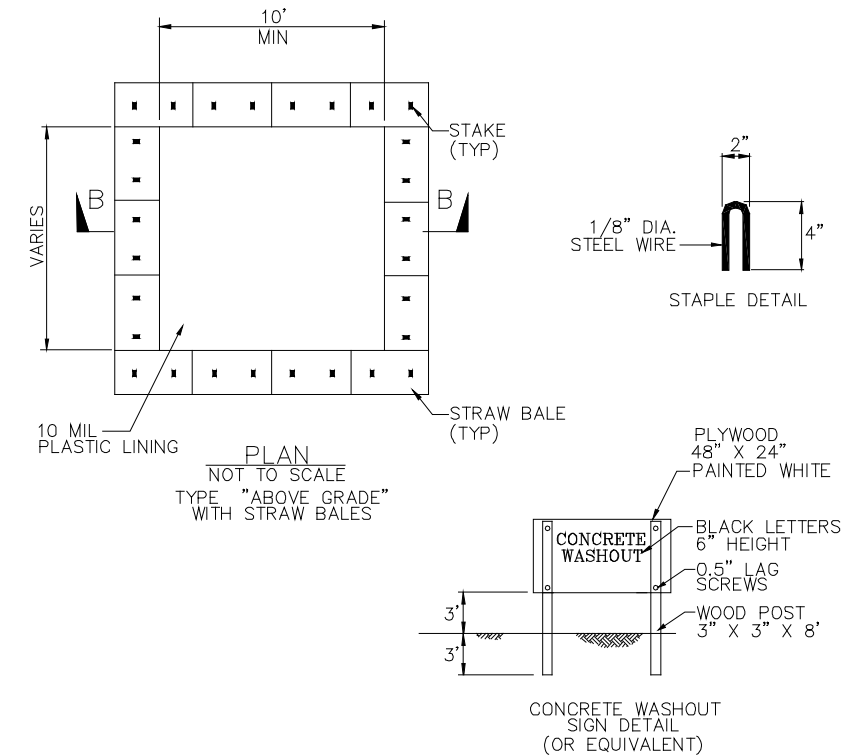

NOTES

1. ACTUAL LAYOUT DETERMINED IN FIELD.
2. THE CONCRETE WASHOUT SIGN SHALL BE INSTALLED WITHIN 30 FT. OF THE TEMPORARY CONCRETE WASHOUT FACILITY.

Sanitary/Septic Waste Management WM-9

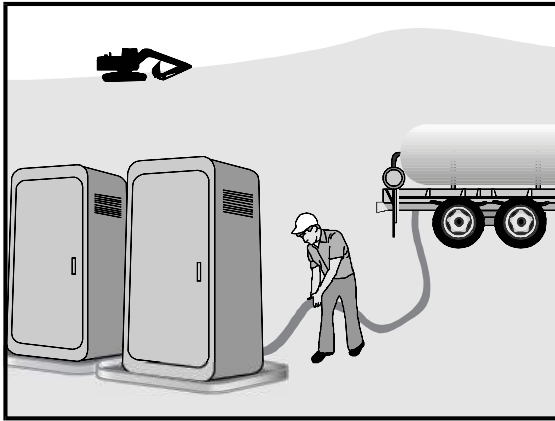

Description and Purpose

Proper sanitary and septic waste management prevent the discharge of pollutants to stormwater from sanitary and septic waste by providing convenient, well-maintained facilities, and arranging for regular service and disposal.

Suitable Applications

Sanitary septic waste management practices are suitable for use at all construction sites that use temporary or portable sanitary and septic waste systems.

Limitations

None identified.

Implementation

Sanitary or septic wastes should be treated or disposed of in accordance with state and local requirements. In many cases, one contract with a local facility supplier will be all that it takes to make sure sanitary wastes are properly disposed.

Storage and Disposal Procedures

- Temporary sanitary facilities should be located away from drainage facilities, watercourses, and from traffic circulation. If site conditions allow, place portable facilities a minimum of 50 feet from drainage conveyances and traffic areas. When subjected to high winds or risk of high winds, temporary sanitary facilities should be secured to prevent overturning.

Categories

EC	Erosion Control	
SE	Sediment Control	
TC	Tracking Control	
WE	Wind Erosion Control	
NS	Non-Stormwater Management Control	
WM	Waste Management and Materials Pollution Control	<input checked="" type="checkbox"/>

Legend:

- Primary Category
- Secondary Category

Targeted Constituents

Sediment	
Nutrients	<input checked="" type="checkbox"/>
Trash	<input checked="" type="checkbox"/>
Metals	
Bacteria	<input checked="" type="checkbox"/>
Oil and Grease	
Organics	<input checked="" type="checkbox"/>

Potential Alternatives

None

If User/Subscriber modifies this fact sheet in any way, the CASQA name/logo and footer below must be removed from each page and not appear on the modified version.



Sanitary/Septic Waste Management WM-9

- Temporary sanitary facilities must be equipped with containment to prevent discharge of pollutants to the stormwater drainage system of the receiving water.
- Consider safety as well as environmental implications before placing temporary sanitary facilities.
- Wastewater should not be discharged or buried within the project site.
- Sanitary and septic systems that discharge directly into sanitary sewer systems, where permissible, should comply with the local health agency, city, county, and sewer district requirements.
- Only reputable, licensed sanitary and septic waste haulers should be used.
- Sanitary facilities should be located in a convenient location.
- Temporary septic systems should treat wastes to appropriate levels before discharging.
- If using an onsite disposal system (OSDS), such as a septic system, local health agency requirements must be followed.
- Temporary sanitary facilities that discharge to the sanitary sewer system should be properly connected to avoid illicit discharges.
- Sanitary and septic facilities should be maintained in good working order by a licensed service.
- Regular waste collection by a licensed hauler should be arranged before facilities overflow.
- If a spill does occur from a temporary sanitary facility, follow federal, state and local regulations for containment and clean-up.

Education

- Educate employees, subcontractors, and suppliers on sanitary and septic waste storage and disposal procedures.
- Educate employees, subcontractors, and suppliers of potential dangers to humans and the environment from sanitary and septic wastes.
- Instruct employees, subcontractors, and suppliers in identification of sanitary and septic waste.
- Hold regular meetings to discuss and reinforce the use of sanitary facilities (incorporate into regular safety meetings).
- Establish a continuing education program to indoctrinate new employees.

Costs

All of the above are low cost measures.

Sanitary/Septic Waste Management WM-9

Inspection and Maintenance

- BMPs must be inspected in accordance with General Permit requirements for the associated project type and risk level. It is recommended that at a minimum, BMPs be inspected weekly, prior to forecasted rain events, daily during extended rain events, and after the conclusion of rain events.
- Arrange for regular waste collection.
- If high winds are expected, portable sanitary facilities must be secured with spikes or weighed down to prevent over turning.
- If spills or leaks from sanitary or septic facilities occur that are not contained and discharge from the site, non-visible sampling of site discharge may be required. Refer to the General Permit or to your project specific Construction Site Monitoring Plan to determine if and where sampling is required.

References

Stormwater Quality Handbooks - Construction Site Best Management Practices (BMPs) Manual, State of California Department of Transportation (Caltrans), March 2003.

Stormwater Management for Construction Activities; Developing Pollution Prevention Plans and Best Management Practice, EPA 832-R-92005; USEPA, April 1992.

APPENDIX B: CALOES CDFW FLOOD DEBRIS CLEANUP AND MANAGEMENT BMPS

2023 CalOES CDFW Flood Debris Cleanup and Management Best Management Practices

California Department of Fish and Wildlife

Sections 1.0 and 2.0 of this document contain the statewide Best Management Practices (BMPs) developed by the California Department of Fish and Wildlife (CDFW) for use and incorporation for the flood debris removal and management activities associated with the 2023 Atmospheric River Storm Events. These BMPs are provided to assist lead agencies and contractors conducting emergency cleanup activities while minimizing the environmental impacts of those activities. **These BMPs do not overlap with or include federal regulations or requirements.** As such, lead agencies and contractors are responsible for meeting federal permitting needs and ensuring compliance with federal environmental regulations prior to initiating project activities.

These BMPs are intended to assist with expeditious cleanup and recovery of debris resulting from the 2023 Atmospheric River storm events. **These BMPs are not intended to replace the notification and permitting requirements for permanent replacement of structures and infrastructure lost to rainstorms or flooding unless otherwise noted.** Construction of permanent structures must be carried out according to existing state and local regulations. In the case of structures crossing watercourses, temporary crossings are allowed under these BMPs for the purpose of access to areas where cleanup efforts will be conducted and are finite in duration. Construction and replacement of permanent structures crossing watercourses are considered activities not covered by these BMPs and must be compliant with applicable planning, CEQA, and permitting requirements.

CDFW anticipates the Governor's Office of Emergency Services (Cal OES) may retain consulting services to assist in the development of supplemental BMPs to address circumstances not expressly covered by these BMPs. BMPs recommended by Cal OES and any consultant it retains must be approved by CDFW before implementation. Any omission in these BMPs or failure to account for a particular set of circumstances should not be construed as a determination by CDFW that no BMPs are warranted.

Potential impacts from Private Property Debris Removal (PPDR) activities include:

- Deposit of hazardous or non-hazardous waste into watercourses and terrestrial habitat, including, but not limited to, green waste (e.g., branches, stumps, trees), treated wood (e.g., utility poles, fencing, decks), roadway materials (e.g., asphalt, concrete, sediments), vehicles, vessels, and other mixed commercial and residential waste.

2023 CalOES CDFW Flood Debris Cleanup and Management Best Management Practices

- Alteration of the bed, bank, or channel of any river, stream or lake resulting in a substantial impact to in-stream or riparian habitats.
- Removal of habitat and habitat elements, including historical nest and roosting trees, active nests/roosts/dens, foraging habitat, and riparian habitat.
- Take of species listed under the California Endangered Species Act or Fully Protected Species under Fish and Game Code.
- Degradation of habitat or harm to special status species listed under the Native Plant Protection Act and other provisions of the California Fish and Game Code.
- Introduction of non-native invasive species into vulnerable habitats.

1.0 **Statewide CDFW BMPs**

1.1 **Project Planning**

1.1.1 CDFW Consultation. It is imperative to consult with CDFW early in the project planning phase to ensure planned activities will be in compliance with these BMPs. CDFW should be consulted **only** by the Operations Chief, Debris Group Supervisor, or designee, to ensure work, including in-water work, such as, temporary crossing sites, staging areas, and access routes, do not impact sensitive habitat or species. If project activities will occur near or in sensitive habitat (habitat upon which sensitive species depend), or wildlife have been identified on site and cannot leave of their own volition, the Operations Chief, Debris Group Supervisor, or designee should reference Section 1.6 on how to proceed. To identify the appropriate CDFW Cal OES contact for consultation during project planning, please refer to Exhibit 1.0.

1.1.2 Qualified Biologist. If it is determined the project will need a qualified biologist, the biologist should hold a wildlife biology, botany, ecology, forestry, or other relevant degree from an accredited university and: 1) be knowledgeable in relevant species life histories and ecology, 2) be able to correctly identify relevant species and habitats, 3) have experience conducting field surveys of relevant species or resources, 4) be knowledgeable about survey protocols, 5) be knowledgeable about state and federal laws regarding the protection of special-status species, and 6) have experience with CDFW's California Natural Diversity Database (CNDDDB) and Biogeographic Information and Observation System (BIOS). The project proponent will review the resume and ensure the above qualifications of the biologist are met prior to beginning work. If species-

2023 CalOES CDFW Flood Debris Cleanup and Management Best Management Practices

specific protocol surveys are performed, surveys will be conducted by the qualified biologist with the minimum qualifications required by the appropriate protocols, including having CDFW or USFWS approval to conduct such surveys if required by certain protocols. If the size of the project warrants more than one qualified biologist, one of the qualified biologists should be designated the lead qualified biologist and be the primary point of contact for the biological elements of the project.

1.1.3 Spill Response Plan. A spill response plan should be prepared, prior to the start of project activities if feasible, that identifies how hazardous materials will be stored and removed from the site, and the actions to be taken in the event of a spill of concrete, petroleum products, sediment, or other hazardous material. The plan should:

- Reference the [California State Oil Spill Contingency Plan](#),
- Identify the steps to be followed in the event of a spill,
- Have clear instructions on immediate reporting, and
- Identify the emergency response materials which will be kept at the project site to allow the rapid containment and clean-up of any spilled material.

If a spill occurs, notifications should be made according to the California State Oil Spill Contingency Plan, to the Regional Water Board (via the State Warning Center), and CDFW contacts (Exhibit 1.0), in addition to the following contacts:

- California State Warning Center - (800) 852-7550 or (916) 845-8911
- Federal – National Response Center - (800) 424-8802 or (202) 267-2675
- Local Government - 911 or other designated local number

1.1.4 On-Site Education Training. If feasible, the qualified biologist should conduct a pre-project training program for all employees, contractors, or personnel working within the project site prior to performing any work. The program should consist of a presentation from the qualified biologist that includes a discussion of the biology of the habitats and special-status species identified during project scoping. The qualified biologist should also include as part of the education program information about the distribution and habitat needs of any special-status species that may be present and project-specific protective measures included in these BMPs. Interpretation should be provided for non-English speaking employees, contractors, or personnel prior to their performing any work at the project site. A handout that summarizes the education program including images

2023 CalOES CDFW Flood Debris Cleanup and Management Best Management Practices

of special-status species should also be distributed to all personnel working on the project.

- 1.1.5 In-Water Work. When project activities will require working within watercourses, installing temporary access through watercourses, and/or removal or placement of materials within the bed, bank, or channel of watercourses, work must be performed in compliance with federal notification and permitting requirements.
- 1.1.6 Permanent Replacement of Watercourse Crossings. These BMPs are intended to assist with the timely removal, storage, transportation, and disposal of hazardous and non-hazardous solid waste and debris resulting from the 2023 Atmospheric River storm events. These BMPs are not intended to be utilized for permanent replacement of watercourse crossings and other in-water infrastructure, such as culverts, that have been destroyed. In the event permanent replacement of a watercourse crossing and/or other in-water infrastructure is needed for access to a primary dwelling or for emergency services, CDFW should be consulted early in the planning phase to discuss permitting requirements for these activities to minimize impacts to the watercourse.

1.2 Pollution Prevention and Equipment Storage

- 1.2.1 Hazardous Materials. Debris, soil, silt, bark, slash, sawdust, mulch, rubbish, creosote-treated wood, raw cement/concrete, or washings thereof, asphalt, paint or other coating material, oil or other petroleum products, or any other substances resulting from project related activities which could be hazardous should be prevented from contaminating the soil and/or entering any watercourse bed, bank, or channel or lake margin by either being removed daily or stored in watertight containers onsite until removed.
- 1.2.2 Equipment Maintenance and Fueling. No equipment maintenance, fueling, or storage should occur within or next to a watercourse bed, bank, or channel or lake margin where petroleum products or other pollutants from the equipment may enter these areas.
- 1.2.3 Equipment and Vehicle Leaks. Any equipment or vehicles driven and/or operated within or next to a watercourse bed, bank, or channel or lake margin should be checked and maintained daily to prevent leaks of materials that could be harmful to aquatic and terrestrial life or riparian habitat.

2023 CalOES CDFW Flood Debris Cleanup and Management Best Management Practices

- 1.2.4 Stationary Equipment Leaks. Stationary equipment such as motors, pumps, generators, and welders, located within or next to a watercourse bed, bank, or channel or lake margin should be positioned over drip pans.
- 1.2.5 Removal of Trash and Debris. All raw construction materials and waste from the project site following the completion of work should be removed. No litter or construction debris should be deposited within or next to a watercourse bed, bank, or channel or lake margin, or where it may pass into a watercourse bed, bank, or channel or lake margin.

1.3 Sediment and Erosion Control

- 1.3.1 Sediment and Erosion Control Measures. Prior to any ground disturbing work, sediment and erosion control measure materials should be stockpiled on site. Sediment and erosion control measures should be used during all phases of operation where soil, trenching spoils and casting, and sediment and/or debris runoff threatens to enter a watercourse bed, bank, or channel or lake margin. Examples of sediment and erosion control measures include bioengineering, silt fencing, compost socks, coir logs, coir rolls, straw waddles, straw bale dikes, planting, mulching, seeding and high-tack hydroseeding with native species or a noxious weed-free seed mix recommended for the county in which the project takes place. Sediment and erosion control measures should be installed in a manner that prevents erosion of the site and prevents sediment and debris from entering a watercourse.

Where vegetation cannot reasonably be expected to become established and erosion control measures are intended for more than one season, the materials used should consist of non-synthetic, biodegradable materials. For example, tacked-down jute erosion control blankets, coconut fiber matting, jute netting, and other soil stabilization methods or similar should be used. Broadcast straw or other mulch is acceptable on soil with little to no slope and in areas that are not exposed to wind.

Materials (e.g., monofilament netting) used in the sediment barriers should not pose an entanglement risk to fish or wildlife.

- 1.3.2 Sediment Traps for Runoff from Steep Areas. Preparations should be made so that runoff from steep, erodible surfaces will be diverted into stable areas with little erosion potential or contained behind erosion control structures or sediment traps. Erosion control measures such as straw bales, waddles, coir socks and/or siltation control fencing/silt barriers should be placed and maintained until the threat of erosion ceases. Frequent water-

2023 CalOES CDFW Flood Debris Cleanup and Management Best Management Practices

bars or other appropriate features should be installed on dirt roads, equipment tracks, or other work trails to control erosion.

- 1.3.3 Maintenance of Sediment and Erosion Control Measures. Sediment and erosion control measures should be maintained in good operating condition until final sign off of the property by the Incident Management Team (IMT). Maintenance includes, but is not limited to, checking sediment and erosion control measures for trapped or entangled fish and wildlife, removing accumulated sediment, repair and or and replacement of damaged sediment and erosion control measures. Modifications, repairs, and improvements should be made to the sediment and erosion control measures whenever needed to maintain them in good operating condition. If a sediment barrier fails to retain sediment, corrective measures should be employed, and a biological monitor should be notified, immediately.

1.4 Watercourse Crossings and In-Water Activities

- 1.4.1 Equipment Limitation Zone. A minimum 25-foot buffer for side slope steepness of less than 30% and a minimum 50-foot buffer for side slope steepness of greater than 30% on either side of watercourses should be implemented when possible as an Equipment Limitation Zone (ELZ). The intent of the ELZ is to reduce or eliminate the likelihood of ground disturbance from heavy equipment that may result in ruts, erosion, and direct sediment delivery to the watercourse. Heavy equipment and vehicles will limit operations within the ELZ unless removal of structures or debris are necessary.
- 1.4.2 If temporary watercourse crossings will occur, locations within the ELZ will be clearly indicated with signage or flagging, and sediment and erosion control methods will be used to minimize impacts within the ELZ. When operations at that location end, these erosion control methods should be removed, and the location should be returned to baseline.
- 1.4.3 Temporary Watercourse Crossings. If an existing or new temporary watercourse crossing must be used, the crossing site should be inspected by the qualified biologist for fish, wildlife, and special-status plant species prior to entering the watercourse. When fish or wildlife have been identified on site either prior to or during project activities and cannot leave of their own volition, the Operations Chief, Debris Group Supervisor, or designee should reference Section 1.6 on how to proceed.

2023 CalOES CDFW Flood Debris Cleanup and Management Best Management Practices

- 1.4.4 Culvert Removal and Replacement. When debris removal activities require removal of a damaged culvert, and the culvert site is within a wetted portion of the watercourse, sediment and erosion control measures should be deployed up and downstream of the removal site to contain sediment-laden water to the immediate area of the culvert removal. If culvert replacement is needed to re-establish or maintain access to a primary dwelling or for emergency services, CDFW should be consulted early in the planning phase to discuss permitting requirements for activities not covered by these BMPs to minimize impacts to the watercourse.
- 1.4.5 Do Not Impair Water Flow. The installation of temporary watercourse crossings should be installed such that water flow is not impaired and fish passage is not obstructed. If temporary watercourse crossings are to be used during high seasonal flows, such crossings should accommodate those flows or should be removed before such flows occur.
- 1.4.6 Temporary Crossing Materials. Materials and methods used for temporary watercourse crossings should cause minimal turbidity or siltation. Aggregate gravel between 2-6-inches (as appropriately sized), screened river gravels, clean washed 2-inch or more rock or gravel, and/or logs in fill materials should be included. Temporary watercourse crossing abutments below the high-water mark should be rock or logs.
- 1.4.7 Stabilize Crossing Sites. All bare soil exposed in conjunction with temporary watercourse crossing construction, deconstruction, maintenance, or repair, should be treated with sediment and erosion control measures, as referenced in Section 1.3.1, immediately upon completion of work on the crossing, and prior to the onset of precipitation capable of generating runoff.
- 1.4.8 In-Water Silt Barriers. If work or temporary watercourse crossings must occur within a wetted watercourse or lake margin, precautions to minimize turbidity and siltation should be used and may require the placement of silt fencing, coir logs, coir rolls, straw bale dikes, or other siltation barriers so that silt and/or other deleterious materials are not allowed to pass to downstream reaches. **Materials used in the silt barrier should not pose an entanglement risk to fish or wildlife.**
- 1.4.9 Maintenance of Silt Barriers. Silt collected around the silt barriers should be removed on an as-needed basis to prevent silty/turbid water from flowing around the silt barriers during storm events and to allow the silt barriers to

2023 CalOES CDFW Flood Debris Cleanup and Management Best Management Practices

function properly. Silt barriers that trap sediment should be removed when temporary crossings have been taken out and after all flowing water is cleared of turbidity in a manner that will not introduce silt to the stream. The stream should then be remediated to baseline condition.

- 1.4.10 Bank Stabilization. When needed, temporary bank stabilization should be installed with suitable non-erodible materials that will withstand wash out. The bank stabilization material should extend above the ordinary high-water mark. Only clean material such as rock riprap that is free of trash, debris and harmful material should be used as bank stabilization materials. Asphalt and concrete should not be considered an acceptable material. At no time should bank stabilization methods incorporate grouting.
- 1.4.11 Removal of Watercourse Crossings. All materials used in constructing temporary watercourse crossings should be removed once the project is complete. During temporary watercourse crossing removal, all fill material should be excavated in a manner that recreates the natural channel grade and orientation, with a channel bed that is as wide as or slightly wider than the original watercourse.

1.5 Vegetation and Tree Clearing

- 1.5.1 Pre-project Site Survey. Before the start of project activities, the qualified biologist with the designated construction monitor (e.g., Task Force Lead (TFL)) should survey the project area to ensure no CESA-listed or special-status fish, wildlife, plant species are present, and no active nests, nest cavities, roosts, roost trees, dens, egg masses, or redds are present. When project activities are proposed within the wetted portion of a watercourse or lake margin, the qualified biologist with the designated construction monitor should survey the area prior to the start of project activities. When habitat elements with active nests, nest cavities, roosts, roost trees, dens, egg masses, or redds are detected, the qualified biologist with the designated construction monitor should refer to Section 1.6 on how to proceed.
- 1.5.2 Vegetation Removal. Disturbance or removal of vegetation should be kept to the minimum necessary to complete project related activities.
- 1.5.3 Remove Cleared Material from Watercourses. All trimmed or cleared material and/or vegetation should be removed from the area and deposited where it cannot re-enter the watercourse or lake margin.

2023 CalOES CDFW Flood Debris Cleanup and Management Best Management Practices

1.5.4 Non-Commercial Tree Removal. Trees being removed should be evaluated by a certified arborist, if feasible. The evaluation should determine the viability of trees marked for removal before tree removal activities begin. If possible, retain large snags, trees with basal hollows or cavities, trees with limbs greater than 6-inches in diameter, old-growth trees, stand-alone granary trees, or other trees with features providing valuable habitat where no immediate risk to infrastructure exists. If avoidable, no trees should be felled in a manner in which they might fall into a watercourse. When a tree with an active bat roost is selected for removal, refer to Measure 1.6.4 on how to proceed.

1.6 Wildlife Protection

- 1.6.1 Construction Monitoring. Project activities should be monitored daily by a construction monitor (Designated Construction Monitor). The qualified biologist assigned to the project should act as the Designated Construction Monitor when on-site. The qualified biologist should either be on-site or be available to arrive on site within two hours during all project activities. Should a project site have CESA-listed species that may be impacted during operations and the qualified biologist cannot be present on-site, either the Operations Chief, Debris Group Supervisor, or their designee with training in application of BMPs may act as Designated Construction Monitor and oversee project activities temporarily until the qualified biologist is available. At a minimum, the designated construction monitor should have attended the on-site education training and daily clearance survey, if provided.
- 1.6.2 Daily Clearance Survey. Before the start of daily project activities, the qualified biologist or designated construction monitor should survey the project area to ensure no new active nests, nest cavities, roosts, dens, egg masses, or redds have become established, including surveying any excavated areas within the project area to ensure trapped fish or wildlife are allowed an opportunity to escape. This includes inspecting around and inside any open-ended pipes or infrastructure elements stored on the project site that will be moved or utilized during project activities.
- 1.6.3 Detection of Wildlife. When wildlife is encountered during project activities, the wildlife should be allowed to leave the project area unharmed. If any CESA-listed or Fully Protected wildlife is encountered, the qualified biologist or designated construction monitor should be notified, and the detection reported to the CDFW Cal OES contact by the

2023 CalOES CDFW Flood Debris Cleanup and Management Best Management Practices

Operations Chief, Debris Group Supervisor, or designee. If the wildlife is discovered to be caught in any pits, ditches, or other types of excavations, the qualified biologist should evaluate if it is unable to escape on its own, and if not, then the qualified biologist should capture and release it outside the project area into the most suitable habitat near the project area. Project activities should not be ceased if the observed wildlife is birds flying over or through the project area.

1.6.3.1 When detected wildlife occurs in active nests, dens, roosts, roost trees, egg masses, redds, and/or nest cavities a buffer should be established between ongoing project activities and the detection site so the wildlife are not disturbed, and it can be identified to species. The buffer should be delineated by temporary fencing or markers and remain in effect throughout project activities or until active nests, dens, roosts, roost trees, location of egg masses, redds, and/or nest cavities is/are no longer active, as determined by the qualified biologist. The buffer(s) should be determined by the qualified biologist and based on the life history of the species detected, including their sensitivity to noise, vibration, ambient levels of human activity and general disturbance, the current site conditions (screening vegetation, terrain, etc.), and the various project-related activities necessary to implement the project. If feasible, consider leaving some larger diameter snags and/or downed logs nearby that may provide food source and shelter for wildlife.

1.6.3.2 When detected wildlife is determined to not be a CESA-listed or Fully Protected Species and a buffer is not feasible while allowing work to continue, and the species is not protected by federal regulations, the qualified biologist may attempt to safely capture and relocate the wildlife to outside the project area if capture is feasible and will not endanger the wildlife.

1.6.3.3 When detected wildlife is determined to be a CESA-listed or Fully Protected species or evidence of their active presence is identified, the detection site should be buffered and all project activities at and immediately adjacent to the detection site should cease until consultation between the Operations Chief, Debris Group Supervisor, or designee and the CDFW Cal OES contact occurs.

1.6.4 Tree Removal with Active Bat Roost. When a tree with an active bat roost is selected for removal, the tree should be removed using a two-step removal process. The limbs of the tree should be removed and left on the

2023 CalOES CDFW Flood Debris Cleanup and Management Best Management Practices

ground while the trunk is left in place during the first day, and during the following day the trunk should be removed. This process will allow the bats the opportunity to vacate the roost during the night prior to the trunk removal.

- 1.6.5 Rock Outcrops and Downed Logs. When rock outcroppings and downed logs that may provide shelter for wildlife are present within the project area, a buffer should be installed to exclude the feature from the area where active work is being performed. If downed logs and/or boulders must be removed, the qualified biologist with a designated construction monitor should survey the area prior to start of removal activities. Wildlife discovered should be allowed to move out of the area by their own volition, if they do not, then the qualified biologist should capture and release the wildlife outside the project area into the most suitable habitat near the project area.
- 1.6.6 Escape Ramp in Trench. At the end of each workday, an escape ramp should be placed at each end of any open excavation to allow wildlife that may become trapped to climb out overnight. The ramp may be constructed of either dirt fill or wood planking or other suitable material that is placed at an angle no greater than 30 degrees and has enough traction to allow wildlife to escape.
- 1.6.7 Injured Wildlife. If any injured wildlife is found within the project site, the qualified biologist should arrange with a CDFW-qualified wildlife rescue and rehabilitation facility to temporarily hold and care for the wildlife.

1.7 Plant and Habitat Protection

- 1.7.1 Sensitive Habitats and Land Types. During initial project planning, sensitive habitats and land types should be identified during project scoping and by referencing the most current version of *CDFW 2023 Statewide Flood Impacted Habitat and Special Status Species Protective Measures*. Before the start of project deployment, the project site should be visually inspected for wet meadows, vernal pools, areas with biological crusts, pebble plains, quartz deposits (in arid habitats), desert pavement, etc. These areas are extremely sensitive to any disturbance including foot traffic and should be marked with exclusion fencing or similar methods and avoided.

If project logistics necessitate entry into these habitat types, consultation between the CDFW Cal OES contact and the Operations Chief, Debris

2023 CalOES CDFW Flood Debris Cleanup and Management Best Management Practices

Group Supervisor, or designee for additional site-specific measures should occur prior to any entry into those habitats. Additional measures could include, but are not limited to, full avoidance, seasonal avoidance, transplanting, and reseeded.

- 1.7.2 Special-Status Botanical Species. Avoid impacts to rare plant species by identifying areas with rare plants during the appropriate blooming season and establishing work season buffers. If rare, threatened, or endangered plant species are found during operations a 10-foot Equipment Limitation Zone (ELZ) should be placed around the population. If trees are to be harvested within the ELZ, trees should be felled away from the core plant populations, if feasible. If avoidance is not possible, the Operations Chief, Debris Group Supervisor, or designee should consult with the CDFW Cal OES contacts listed in Exhibit 1.0 for additional site-specific measures.
- 1.7.3 Invasive Species Prevention. All contractors should follow guidelines in the California Invasive Plant Council's [Preventing the Spread of Invasive Plants: Best Management Practices for Land Managers \(Cal-IPC 2012\)](#) to prevent the spread of invasive plant species. Equipment should be cleaned of material that may harbor invasive plant seeds or invasive pests before starting a new project in a different watershed. This material includes dirt or plant seeds on construction equipment, tools, boots, and clothing.
- 1.7.4 Disinfect Equipment Prior to Entry into Watercourses. To prevent the spread of invasive aquatics and diseases (e.g., Zebra and Quagga Mussels), equipment to be used in water should be decontaminated according to [CDFW Aquatic Invasive Species Decontamination Protocols 2022](#).

2.0 Species-Specific BMPs based on CDFW Region

2.1 CDFW Regions (<https://wildlife.ca.gov/Regions>):

- Northern Region: Del Norte, Humboldt, Lassen, Mendocino, Modoc, Shasta, Siskiyou, Tehama, and Trinity counties.
- North Central Region: Alpine, Amador, Butte, Calaveras, Colusa, El Dorado, Glenn, Lake, Nevada, Placer, Plumas, Sacramento*, San Joaquin*, Sierra, Sutter, Yolo*, and Yuba counties. *Note: These counties are split between regions. See detailed map in Exhibit 1.1.
- Bay Delta Region: Alameda, Contra Costa, Marin, Napa, Sacramento*, San Mateo, Santa Clara, Santa Cruz, San Francisco, San Joaquin*,

2023 CalOES CDFW Flood Debris Cleanup and Management Best Management Practices

Solano, Sonoma, and Yolo* counties. *Note: These counties are split between regions. See detailed map in Exhibit 1.1.

- Central Region: Fresno, Kern, Kings, Madera, Mariposa, Merced, Monterey, San Benito, San Luis Obispo, Stanislaus, Tulare, and Tuolumne counties.
- South Coast Region: Los Angeles, Orange, San Diego, Santa Barbara, and Ventura counties.
- Inland Deserts Region: Imperial, Inyo, Mono, Riverside and San Bernardino counties.

2.2 CDFW Contacts

CDFW Contacts are contained in Exhibit 1.0.

2.3 Species-Specific Measures

In addition to the measures presented in the EPP, during project scoping the Operations Chief, Debris Group Supervisor, or their designee should reference the most current version of *2023 CDFW Statewide Flood Impacted Habitat and Special Status Species Protective Measures* (exhibit 1.0). This document contains specific habitat and impact information, as well as additional species-specific BMPs for use during project activities. Contact the appropriate CDFW Cal OES contact or Jason Faridi at Jason.Faridi@wildlife.ca.gov for the most current version.

APPENDIX C: EROSION AND SEDIMENT CONTROL DRAWING (ESCD)

EROSION AND SEDIMENT CONTROL PLAN (ESCP) TUNNEL ROAD TRAIL, ROAD AREAS 5-16 AND OTHER SPUR ROADS STORM MAINTENANCE AND CLEAN-UP OPERATIONS SANTA BARBARA, CA

SHEET INDEX

SHEET NO.	DESCRIPTION
1	TITLE SHEET AND EROSION & SEDIMENT CONTROL NOTES
2	DETAIL KEY MAP
3-9	ESCP SHEETS

LEGEND

BEST MANAGEMENT PRACTICES (BMPs)

California Stormwater Quality Association (CASQA)
Construction Handbook, 2009. For detailed BMP installation instructions

SYMBOL: EXPLANATION

	EC-1 SCHEDULING
	EC-2 PRESERVATION OF EXISTING VEGETATION
	EC-3 HYDRAULIC MULCH
	EC-4 HYDROSEEDING
	EC-7 GEOTEXTILES & MATS
	EC-9 EARTH DIKES AND DRAINAGE SWALES
	EC-10 VELOCITY DISSIPATION DEVICES
	EC-11 SLOPE DRAINS
	SE-4 CHECK DAM
	SE-5 FIBER ROLLS
	SE-6 GRAVEL BAG BERM
	SE-7 STREET SWEEPING AND VACUUMING
	SE-8 SAND BAG BERM
	WE-1 WIND EROSION CONTROL
	WM-1 MATERIAL DELIVERY AND STORAGE
	WM-2 MATERIAL USE
	WM-3 STOCKPILE MANAGEMENT
	WM-4 SPILL PREVENTION AND CONTROL
	WM-5 SOLID WASTE MANAGEMENT
	WM-9 SANITARY/SEPTIC WASTE MANAGEMENT
	NS-9 VEHICLE AND EQUIPMENT FUELING
	NS-10 VEHICLE AND EQUIPMENT MAINTENANCE
	DIRECTION OF FLOWS
	WORK AREA - CENTER LINE
	CONCENTRATED FLOW PATH
	PROPOSED EARTHEN BERM
	PROPOSED DRAINAGE FEATURE
	*CHECK DAM (SE-4)
	*FIBER ROLL (SE-5)
	*GRAVEL BAG BERM (SE-6)
	*STORM DRAIN INLET PROTECTION (SE-10)
	*EROSION CONTROL BLANKET (EC-7)
	*[T] TRAILER
	*[CW] CONCRETE WASHOUT
	*[EM] VEHICLE & EQUIPMENT MAINTENANCE/STAGING AREA
	*[M1] MATERIAL STORAGE
	*[ST] STOCKPILE AREA
	*[W] CONSTRUCTION WASTE STORAGE
	*[PT] PORTABLE TOILET

* LOCATION TO BE SHOWN BY CONTRACTOR DURING CONSTRUCTION

PREPARED BY MICHAEL BAKER INTERNATIONAL

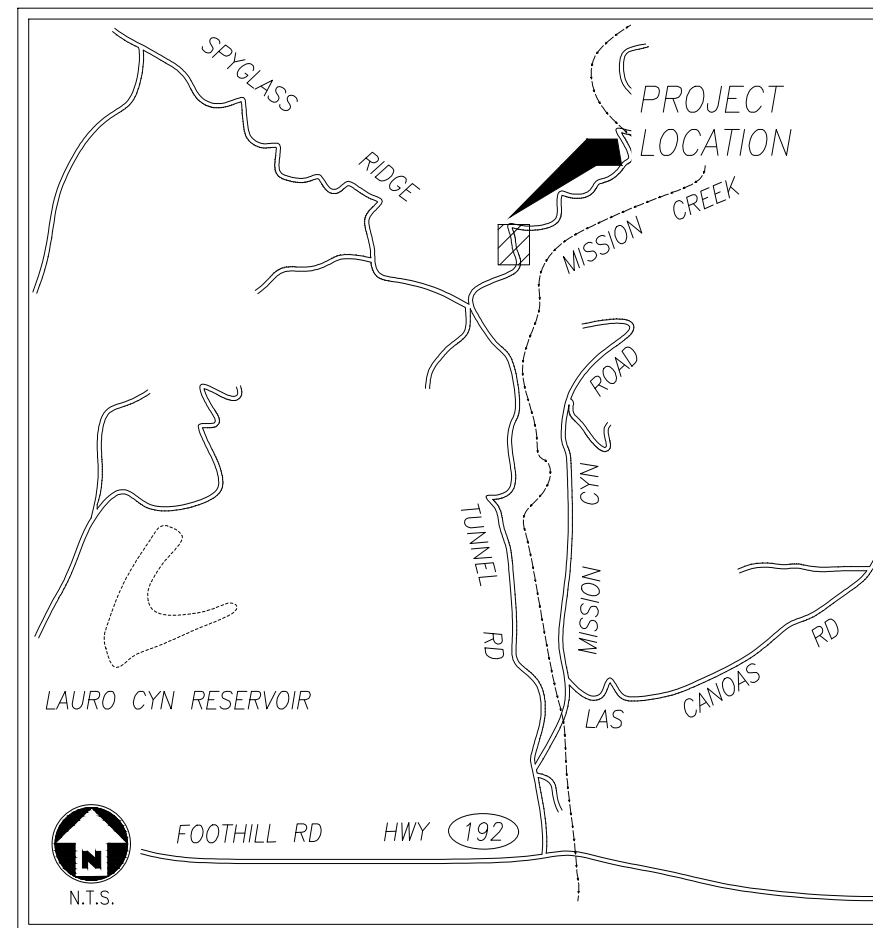

VICINITY MAP

EROSION AND SEDIMENT CONTROL NOTES

- BMPs AS SHOWN HEREIN, SHALL BE INSTALLED PER THE CASQA BMP FACT SHEETS INCLUDED WITH THESE PLANS.
- THE INFORMATION ON THESE DRAWINGS IS ACCURATE FOR EROSION AND SEDIMENT CONTROL PURPOSES ONLY. CONTRACTOR SHALL NOTIFY THE PREPARER IMMEDIATELY OF ANY DISCREPANCIES BETWEEN THE APPROVED CONSTRUCTION PLAN, IF APPLICABLE, AND THE INFORMATION SHOWN IN THE SWPPP.
- THE INFORMATION ON THIS PLAN IS INTENDED TO BE USED AS A GUIDELINE FOR THE CONTRACTOR AND SUBCONTRACTORS TO INSTALL EROSION AND SEDIMENT CONTROL DEVICES AT GENERAL LOCATIONS THROUGHOUT THE SITE. THESE DRAWINGS ARE TO BE USED IN CONJUNCTION WITH THE NARRATIVE SECTION OF THE SWPPP.
- MINOR ADJUSTMENTS TO BMP PLACEMENT AND SEQUENCE OF BMP IMPLEMENTATION ARE ANTICIPATED IN THE FIELD DURING CONSTRUCTION DUE TO CONSTRAINTS ASSOCIATED WITH CONSTRUCTION ACTIVITIES, SCHEDULING AND UNFORESEEN FIELD CONDITIONS. THE PREPARER, OR THE ASSIGNED DESIGNER, SHALL APPROVE ALL FIELD ADJUSTMENTS TO THE SWPPP MAPS.
- ALL DISTURBED AREAS MUST HAVE EROSION CONTROLS APPLIED WITHIN 14 DAYS OF INACTIVITY. ADDITIONALLY, UPON COMPLETION OF CONSTRUCTION ACTIVITIES, DISTURBED AREAS SHALL BE PERMANENTLY STABILIZED.
- ALL SPILLS SHALL BE REPORTED IMMEDIATELY. TO THE EXTENT THAT THE WORK CAN BE ACCOMPLISHED SAFELY, SPILLS OF OIL, PETROLEUM PRODUCTS AND SUBSTANCES LISTED UNDER 40CFR PARTS 110, 117, AND 302, AND SANITARY AND SEPTIC WASTES SHOULD BE CONTAINED AND CLEANED UP IMMEDIATELY. (REFER TO CASQA BMP FACT SHEET, WM-4)
- SHOULD GROUNDWATER BE ENCOUNTERED DURING EXCAVATION, CONTACT THE QUALIFIED SWPPP DEVELOPER (QSD) PRIOR TO DEWATERING. FOLLOW ENVIRONMENTAL GUIDELINES FOR DISPOSAL OF GROUNDWATER.
- SHOULD CONTAMINATED SOIL BE ENCOUNTERED DURING GRADING ACTIVITIES, CONTACT THE QSD, FOLLOW ENVIRONMENTAL GUIDELINES FOR DISPOSAL OF CONTAMINATED SOIL.
- THE CONTRACTOR SHALL ENSURE THAT ALL PAVED ROADWAYS UTILIZED BY CONSTRUCTION TRAFFIC ARE SWEEPED AND CLEANED, AS NEEDED, PER CASQA BMP FACT SHEET SE-7.
- CONSTRUCTION SHALL BE CONSIDERED COMPLETE ONCE ALL DISTURBED AREAS HAVE BEEN STABILIZED WITH NON-EROSIVE SURFACES AND ALL CONSTRUCTION-RELATED MATERIALS HAVE BEEN REMOVED FROM THE SITE.

**ESCP Maps were generated for maintenance on unpaved roads.
Reference ESCP for BMP management in Road Areas 1-4.**

Michael Baker INTERNATIONAL
5 Hutton Centre Drive
Suite 500
Santa Ana, CA 92707
Phone: (949) 472-3505
MBAKERINTL.COM

Andrew Price
PROJECT MANAGER

DATE: 03.01.2023

SOUTHERN CALIFORNIA EDISON
An EDISON INTERNATIONAL Company

Tunnel Road Trail, Road Areas 1-16 and Spur Roads
LOCATION SANTA BARBARA COUNTY, CA

Storm Maintenance and Clean-up Operations

FOR: SOUTHERN CALIFORNIA EDISON

SHEET
1
OF 9 SHEETS
FILE NO.:

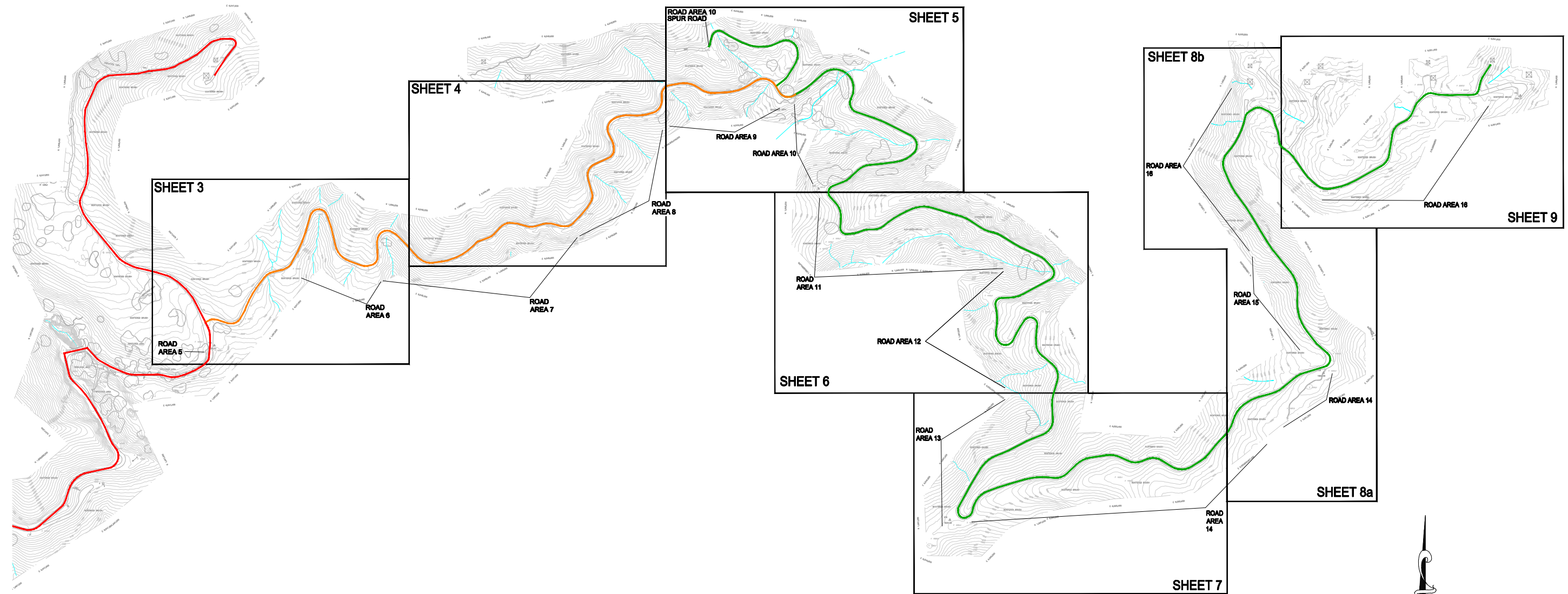

LEGEND

- Concentrated Flow Path
- Road Areas 10-16
- Road Areas 5-9
- Road Areas 1-4

Mac Drains shown in drawing above are not proposed to be completed as part of emergency O&M activities.

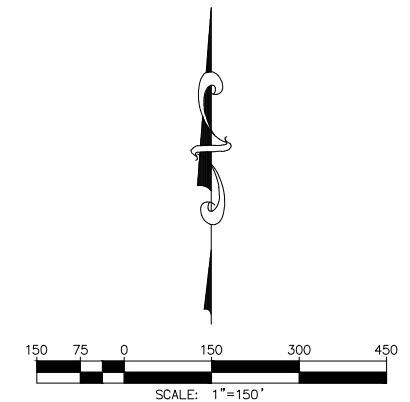

<p>Michael Baker INTERNATIONAL</p> <p>5 Hutton Centre Drive Suite 500 Santa Ana, CA 92707 Phone: (949) 472-3505 MBAKERINTL.COM</p>	<p>SOUTHERN CALIFORNIA EDISON An EDISON INTERNATIONAL Company</p>	<p>Tunnel Road Trail, Road Areas 1-16 and Spur Roads</p>	<p>SHEET 2 OF 9 SHEETS FILE NO.:</p>
		<p>Andrew Price DATE: 03.01.2023</p> <p>PROJECT MANAGER</p>	<p>LOCATION SANTA BARBARA COUNTY, CA</p> <p>Storm Maintenance and Clean-up Operations</p> <p>FOR: SOUTHERN CALIFORNIA EDISON</p>

EROSION CONTROL NOTES

1. PRESERVE EXISTING VEGETATION WHERE POSSIBLE (EC-2).
2. IMPLEMENT/INSTALL WIND EROSION CONTROLS AS NEEDED (WE-1).
3. INSTALL CHECK DAMS (SE-4) THROUGHOUT PROJECT AREA TO BREAK UP CONCENTRATED FLOW PATHS.
4. IMPLEMENT STREET SWEEPING (SE-7) AT GATE NEAR PROJECT ENTRANCE.
5. BMP LOCATIONS ARE APPROXIMATE.
6. CONSTRUCTION SHALL BE CONSIDERED COMPLETE ONCE ALL DISTURBED AREAS HAVE BEEN STABILIZED WITH NON-EROSIVE SURFACES AND ALL CONSTRUCTION-RELATED MATERIALS HAVE BEEN REMOVED FROM THE SITE.

LEGEND

- DIRECTION OF FLOWS
- WORK AREA - CENTER LINE
- CONCENTRATED FLOW PATH
- PROPOSED EARTHEN BERM
- PROPOSED DRAINAGE FEATURE
- *CHECK DAM (SE-4)
- *FIBER ROLL (SE-5)
- *GRAVEL BAG BERM (SE-6)
- *STORM DRAIN INLET PROTECTION (SE-10)
- *EROSION CONTROL BLANKET (EC-7)
- *TRAILER
- *CONCRETE WASHOUT
- *VEHICLE & EQUIPMENT MAINTENANCE/ STAGING AREA
- *MATERIAL STORAGE
- *STOCKPILE AREA
- *CONSTRUCTION WASTE STORAGE
- *PORTABLE TOILET
- * LOCATION TO BE UPDATED BY CONTRACTOR DURING CONSTRUCTION

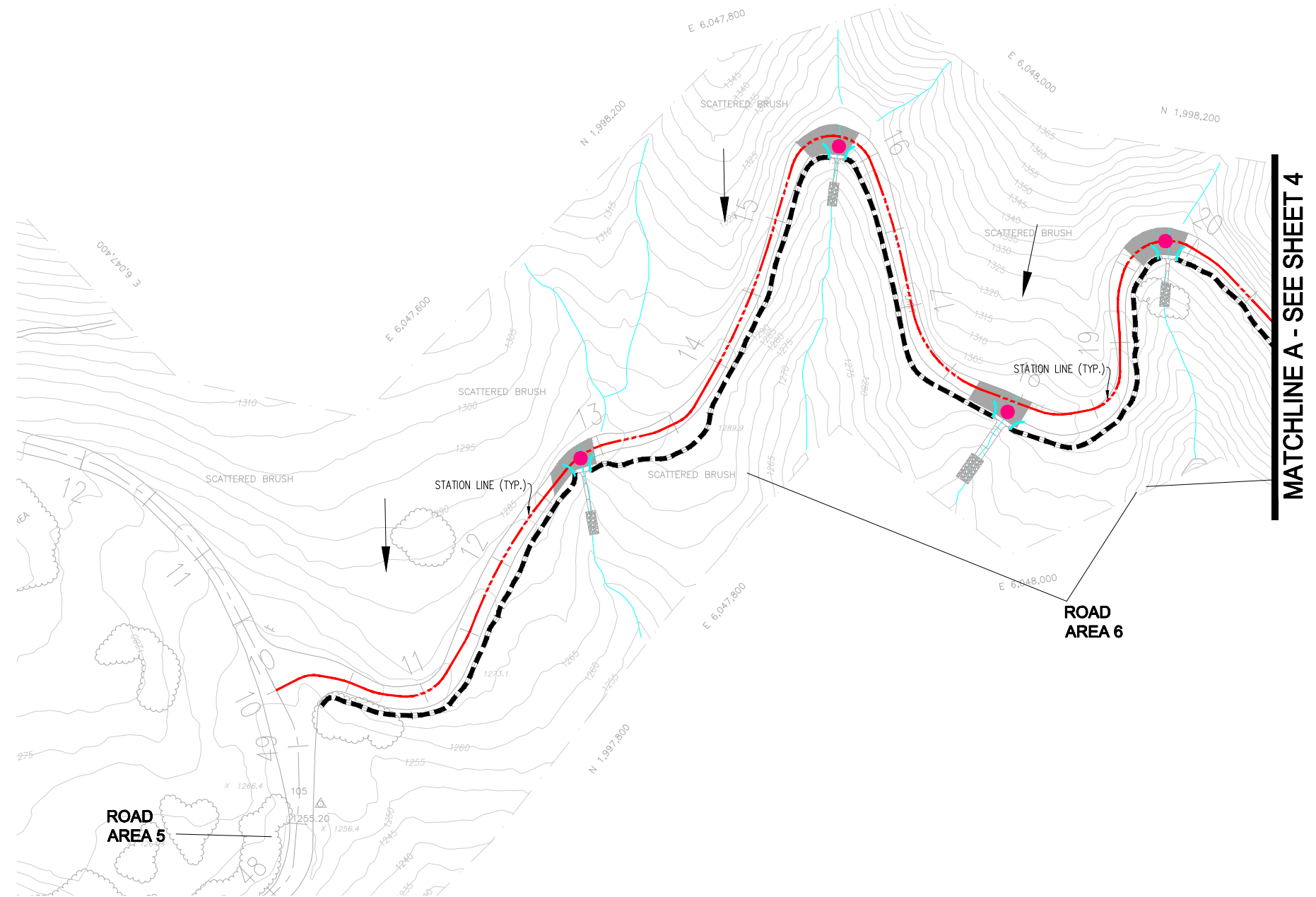
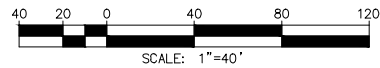

BEST MANAGEMENT PRACTICES (BMPs)

EC-1 SCHEDULING	EC-10 VELOCITY DISSIPATION DEVICES	WM-1 MATERIAL DELIVERY AND STORAGE
EC-2 PRESERVATION OF EXISTING VEGETATION	EC-11 SLOPE DRAINS	WM-2 MATERIAL USE
EC-3 HYDRAULIC MULCH	SE-4 CHECK DAM	WM-3 STOCKPILE MANAGEMENT
EC-4 HYDROSEEDING	SE-5 FIBER ROLLS	WM-4 SPILL PREVENTION AND CONTROL
EC-7 GEOTEXTILES & MATS	SE-7 STREET SWEEPING AND VACUUMING	WM-5 SOLID WASTE MANAGEMENT
EC-9 EARTH DIKES AND DRAINAGE SWALES	WE-1 WIND EROSION CONTROL	WM-9 SANITARY/SEPTIC WASTE MANAGEMENT
		NS-9 VEHICLE AND EQUIPMENT FUELING
		NS-10 VEHICLE AND EQUIPMENT MAINTENANCE

Mac Drains shown in drawing above are not proposed to be completed as part of emergency O&M activities.

Michael Baker INTERNATIONAL
 5 Hutton Centre Drive Suite 500
 Santa Ana, CA 92707
 Phone: (949) 472-3505
 MBAKERINTL.COM

Andrew Price PROJECT MANAGER DATE: 03.01.2023

SOUTHERN CALIFORNIA EDISON
 An EDISON INTERNATIONAL Company

Tunnel Road Trail, Road Areas 1-16 and Spur Roads
 LOCATION SANTA BARBARA COUNTY, CA
 Storm Maintenance and Clean-up Operations
 FOR: SOUTHERN CALIFORNIA EDISON

SHEET
3
 OF 9 SHEETS
 FILE NO.:

EROSION CONTROL NOTES

1. PRESERVE EXISTING VEGETATION WHERE POSSIBLE (EC-2).
2. IMPLEMENT/INSTALL WIND EROSION CONTROLS AS NEEDED (WE-1).
3. INSTALL CHECK DAMS (SE-4) THROUGHOUT PROJECT AREA TO BREAK UP CONCENTRATED FLOW PATHS.
4. IMPLEMENT STREET SWEEPING (SE-7) AT GATE NEAR PROJECT ENTRANCE.
5. BMP LOCATIONS ARE APPROXIMATE.
6. CONSTRUCTION SHALL BE CONSIDERED COMPLETE ONCE ALL DISTURBED AREAS HAVE BEEN STABILIZED WITH NON-EROSIVE SURFACES AND ALL CONSTRUCTION-RELATED MATERIALS HAVE BEEN REMOVED FROM THE SITE.

LEGEND

- DIRECTION OF FLOWS
- WORK AREA - CENTER LINE
- CONCENTRATED FLOW PATH
- PROPOSED EARTHEN BERM
- PROPOSED DRAINAGE FEATURE
- *CHECK DAM (SE-4)
- *FIBER ROLL (SE-5)
- *GRAVEL BAG BERM (SE-6)
- *STORM DRAIN INLET PROTECTION (SE-10)
- *EROSION CONTROL BLANKET (EC-7)
- *T TRAILER
- *CW CONCRETE WASHOUT
- *EM VEHICLE & EQUIPMENT MAINTENANCE/ STAGING AREA
- *M1 MATERIAL STORAGE
- *ST STOCKPILE AREA
- *W CONSTRUCTION WASTE STORAGE
- *PT PORTABLE TOILET
- * LOCATION TO BE UPDATED BY CONTRACTOR DURING CONSTRUCTION

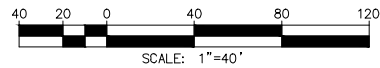

BEST MANAGEMENT PRACTICES (BMPs)

EC-1	SCHEDULING	EC-10	VELOCITY DISSIPATION DEVICES
EC-2	PRESERVATION OF EXISTING VEGETATION	EC-11	SLOPE DRAINS
EC-3	HYDRAULIC MULCH	SE-4	CHECK DAM
EC-4	HYDROSEEDING	SE-5	FIBER ROLLS
EC-7	GEOTEXTILES & MATS	SE-7	STREET SWEEPING AND VACUUMING
EC-9	EARTH DIKES AND DRAINAGE SWALES	WE-1	WIND EROSION CONTROL

WM-1	MATERIAL DELIVERY AND STORAGE
WM-2	MATERIAL USE
WM-3	STOCKPILE MANAGEMENT
WM-4	SPILL PREVENTION AND CONTROL
WM-5	SOLID WASTE MANAGEMENT
WM-9	SANITARY/SEPTIC WASTE MANAGEMENT
NS-9	VEHICLE AND EQUIPMENT FUELING
NS-10	VEHICLE AND EQUIPMENT MAINTENANCE

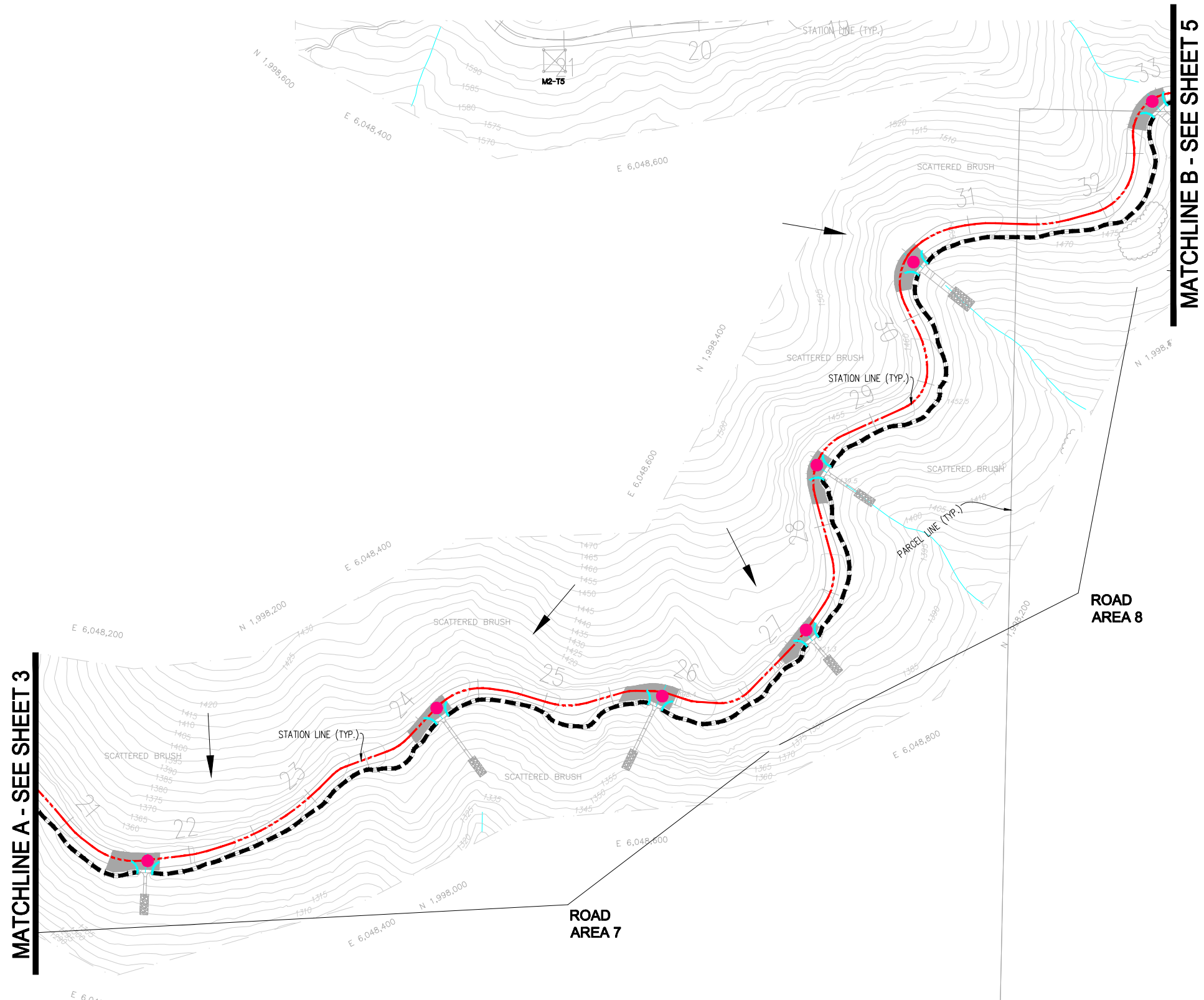

Mac Drains shown in drawing above are not proposed to be completed as part of emergency O&M activities.

Michael Baker INTERNATIONAL
 5 Hutton Centre Drive
 Suite 500
 Santa Ana, CA 92707
 Phone: (949) 472-3505
 MBAKERINTL.COM

Andrew Price
 PROJECT MANAGER

DATE: 03.01.2023

SOUTHERN CALIFORNIA EDISON
 An EDISON INTERNATIONAL Company

Tunnel Road Trail, Road Areas 1-16 and Spur Roads
 LOCATION SANTA BARBARA COUNTY, CA

Storm Maintenance and Clean-up Operations

FOR: SOUTHERN CALIFORNIA EDISON

SHEET
4
 OF 9 SHEETS
 FILE NO.:

EROSION CONTROL NOTES

1. PRESERVE EXISTING VEGETATION WHERE POSSIBLE (EC-2).
2. IMPLEMENT/INSTALL WIND EROSION CONTROLS AS NEEDED (WE-1).
3. INSTALL CHECK DAMS (SE-4) THROUGHOUT PROJECT AREA TO BREAK UP CONCENTRATED FLOW PATHS.
4. IMPLEMENT STREET SWEEPING (SE-7) AT GATE NEAR PROJECT ENTRANCE.
5. BMP LOCATIONS ARE APPROXIMATE.
6. CONSTRUCTION SHALL BE CONSIDERED COMPLETE ONCE ALL DISTURBED AREAS HAVE BEEN STABILIZED WITH NON-EROSIVE SURFACES AND ALL CONSTRUCTION-RELATED MATERIALS HAVE BEEN REMOVED FROM THE SITE.

LEGEND

- DIRECTION OF FLOWS
- WORK AREA - CENTER LINE
- CONCENTRATED FLOW PATH
- PROPOSED EARTHEN BERM
- PROPOSED DRAINAGE FEATURE
- *CHECK DAM (SE-4)
- *FIBER ROLL (SE-5)
- *GRAVEL BAG BERM (SE-6)
- *STORM DRAIN INLET PROTECTION (SE-10)
- *EROSION CONTROL BLANKET (EC-7)
- *T TRAILER
- *CW CONCRETE WASHOUT
- *EM VEHICLE & EQUIPMENT MAINTENANCE/ STAGING AREA
- *M1 MATERIAL STORAGE
- *ST STOCKPILE AREA
- *W CONSTRUCTION WASTE STORAGE
- *PT PORTABLE TOILET
- * LOCATION TO BE UPDATED BY CONTRACTOR DURING CONSTRUCTION

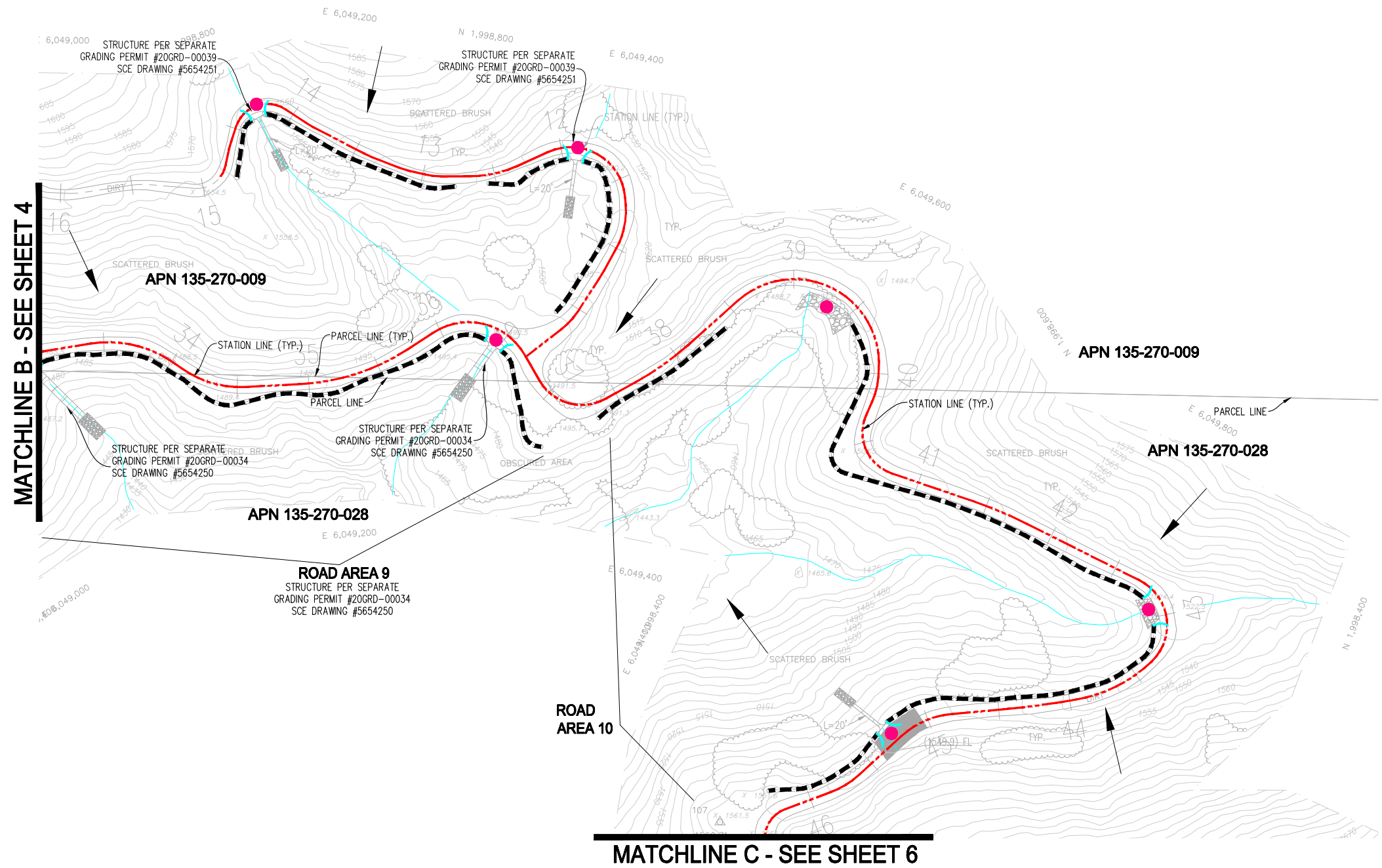
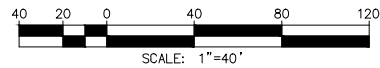

BEST MANAGEMENT PRACTICES (BMPs)

EC-1	SCHEDULING	EC-10	VELOCITY DISSIPATION DEVICES	WM-1	MATERIAL DELIVERY AND STORAGE
EC-2	PRESERVATION OF EXISTING VEGETATION	EC-11	SLOPE DRAINS	WM-2	MATERIAL USE
EC-3	HYDRAULIC MULCH	SE-4	CHECK DAM	WM-3	STOCKPILE MANAGEMENT
EC-4	HYDROSEEDING	SE-5	FIBER ROLLS	WM-4	SPILL PREVENTION AND CONTROL
EC-7	GEOTEXTILES & MATS	SE-7	STREET SWEEPING AND VACUUMING	WM-5	SOLID WASTE MANAGEMENT
EC-9	EARTH DIKES AND DRAINAGE SWALES	WE-1	WIND EROSION CONTROL	WM-9	SANITARY/SEPTIC WASTE MANAGEMENT
				NS-9	VEHICLE AND EQUIPMENT FUELING
				NS-10	VEHICLE AND EQUIPMENT MAINTENANCE

Mac Drains shown in drawing above are not proposed to be completed as part of emergency O&M activities.

Michael Baker INTERNATIONAL
 5 Hutton Centre Drive
 Suite 500
 Santa Ana, CA 92707
 Phone: (949) 472-3505
 M.BAKER@INTL.COM

Andrew Price
 PROJECT MANAGER

DATE: 03.01.2023

SOUTHERN CALIFORNIA EDISON
 An EDISON INTERNATIONAL Company

Tunnel Road Trail, Road Areas 1-16 and Spur Roads
 LOCATION SANTA BARBARA COUNTY, CA

Storm Maintenance and Clean-up Operations

FOR: SOUTHERN CALIFORNIA EDISON

SHEET
5
 OF 9 SHEETS
 FILE NO.:

EROSION CONTROL NOTES

1. PRESERVE EXISTING VEGETATION WHERE POSSIBLE (EC-2).
2. IMPLEMENT/INSTALL WIND EROSION CONTROLS AS NEEDED (WE-1).
3. INSTALL CHECK DAMS (SE-4) THROUGHOUT PROJECT AREA TO BREAK UP CONCENTRATED FLOW PATHS.
4. IMPLEMENT STREET SWEEPING (SE-7) AT GATE NEAR PROJECT ENTRANCE.
5. BMP LOCATIONS ARE APPROXIMATE.
6. CONSTRUCTION SHALL BE CONSIDERED COMPLETE ONCE ALL DISTURBED AREAS HAVE BEEN STABILIZED WITH NON-EROSIVE SURFACES AND ALL CONSTRUCTION-RELATED MATERIALS HAVE BEEN REMOVED FROM THE SITE.

LEGEND

- ← DIRECTION OF FLOWS
- WORK AREA - CENTER LINE
- CONCENTRATED FLOW PATH
- PROPOSED EARTHEN BERM
- PROPOSED DRAINAGE FEATURE
- *CHECK DAM (SE-4)
- *FIBER ROLL (SE-5)
- *GRAVEL BAG BERM (SE-6)
- ⊗ *STORM DRAIN INLET PROTECTION (SE-10)
- ▨ *EROSION CONTROL BLANKET (EC-7)
- * [T] TRAILER
- * [CW] CONCRETE WASHOUT
- * [EM] VEHICLE & EQUIPMENT MAINTENANCE/ STAGING AREA
- * [M1] MATERIAL STORAGE
- * [ST] STOCKPILE AREA
- * [W] CONSTRUCTION WASTE STORAGE
- * [PT] PORTABLE TOILET
- * LOCATION TO BE UPDATED BY CONTRACTOR DURING CONSTRUCTION

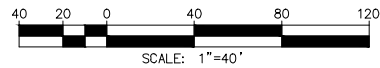

BEST MANAGEMENT PRACTICES (BMPs)

EC-1 SCHEDULING	EC-10 VELOCITY DISSIPATION DEVICES	WM-1 MATERIAL DELIVERY AND STORAGE
EC-2 PRESERVATION OF EXISTING VEGETATION	EC-11 SLOPE DRAINS	WM-2 MATERIAL USE
EC-3 HYDRAULIC MULCH	SE-4 CHECK DAM	WM-3 STOCKPILE MANAGEMENT
EC-4 HYDROSEEDING	SE-5 FIBER ROLLS	WM-4 SPILL PREVENTION AND CONTROL
EC-7 GEOTEXTILES & MATS	SE-7 STREET SWEEPING AND VACUUMING	WM-5 SOLID WASTE MANAGEMENT
EC-9 EARTH DIKES AND DRAINAGE SWALES	WE-1 WIND EROSION CONTROL	WM-9 SANITARY/SEPTIC WASTE MANAGEMENT
		NS-9 VEHICLE AND EQUIPMENT FUELING
		NS-10 VEHICLE AND EQUIPMENT MAINTENANCE

MATCHLINE C - SEE SHEET 5

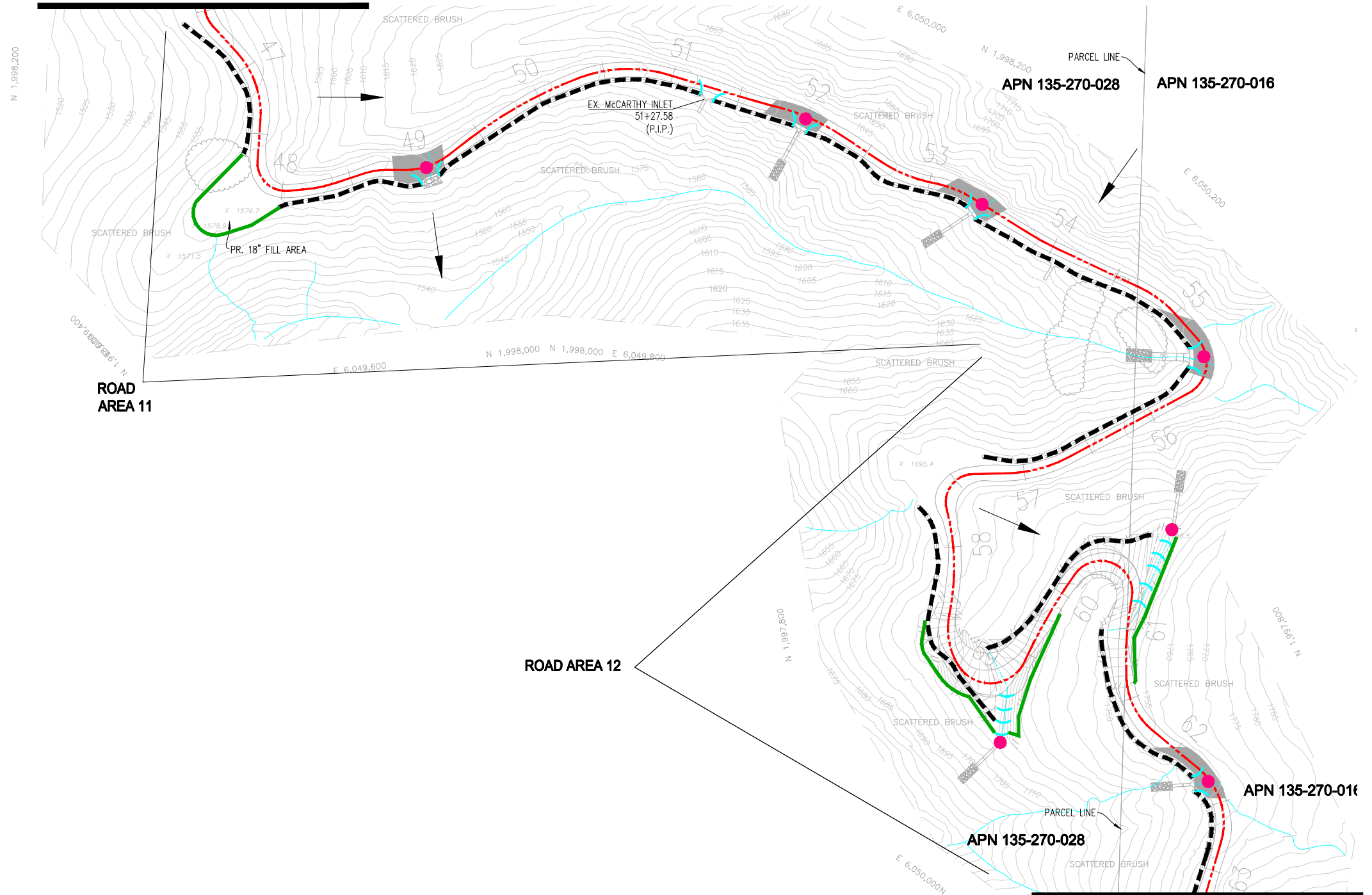

MATCHLINE D - SEE SHEET 7

Mac Drains shown in drawing above are not proposed to be completed as part of emergency O&M activities.

Michael Baker INTERNATIONAL
 5 Hutton Centre Drive Suite 500 Santa Ana, CA 92707
 Phone: (949) 472-3505 MBAKERINTL.COM

Andrew Price PROJECT MANAGER DATE: 03.01.2023

SOUTHERN CALIFORNIA EDISON
 An EDISON INTERNATIONAL Company

Tunnel Road Trail, Road Areas 1-16 and Spur Roads
 LOCATION SANTA BARBARA COUNTY, CA
Storm Maintenance and Clean-up Operations
 FOR: SOUTHERN CALIFORNIA EDISON

SHEET **6** OF 9 SHEETS
 FILE NO.:

EROSION CONTROL NOTES

1. PRESERVE EXISTING VEGETATION WHERE POSSIBLE (EC-2).
2. IMPLEMENT/INSTALL WIND EROSION CONTROLS AS NEEDED (WE-1).
3. INSTALL CHECK DAMS (SE-4) THROUGHOUT PROJECT AREA TO BREAK UP CONCENTRATED FLOW PATHS.
4. IMPLEMENT STREET SWEEPING (SE-7) AT GATE NEAR PROJECT ENTRANCE.
5. BMP LOCATIONS ARE APPROXIMATE.
6. CONSTRUCTION SHALL BE CONSIDERED COMPLETE ONCE ALL DISTURBED AREAS HAVE BEEN STABILIZED WITH NON-EROSIVE SURFACES AND ALL CONSTRUCTION-RELATED MATERIALS HAVE BEEN REMOVED FROM THE SITE.

LEGEND

- DIRECTION OF FLOWS
- WORK AREA - CENTER LINE
- CONCENTRATED FLOW PATH
- PROPOSED EARTHEN BERM
- PROPOSED DRAINAGE FEATURE
- *CHECK DAM (SE-4)
- *FIBER ROLL (SE-5)
- *GRAVEL BAG BERM (SE-6)
- *STORM DRAIN INLET PROTECTION (SE-10)
- *EROSION CONTROL BLANKET (EC-7)
- *TRAILER
- *CONCRETE WASHOUT
- *VEHICLE & EQUIPMENT MAINTENANCE/ STAGING AREA
- *MATERIAL STORAGE
- *STOCKPILE AREA
- *CONSTRUCTION WASTE STORAGE
- *PORTABLE TOILET
- * LOCATION TO BE UPDATED BY CONTRACTOR DURING CONSTRUCTION

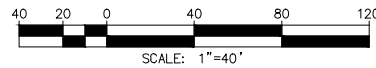

BEST MANAGEMENT PRACTICES (BMPs)

EC-1	SCHEDULING	EC-10	VELOCITY DISSIPATION DEVICES
EC-2	PRESERVATION OF EXISTING VEGETATION	EC-11	SLOPE DRAINS
EC-3	HYDRAULIC MULCH	SE-4	CHECK DAM
EC-4	HYDROSEEDING	SE-5	FIBER ROLLS
EC-7	GEOTEXTILES & MATS	SE-7	STREET SWEEPING AND VACUUMING
EC-9	EARTH DIKES AND DRAINAGE SWALES	WE-1	WIND EROSION CONTROL

WM-1	MATERIAL DELIVERY AND STORAGE
WM-2	MATERIAL USE
WM-3	STOCKPILE MANAGEMENT
WM-4	SPILL PREVENTION AND CONTROL
WM-5	SOLID WASTE MANAGEMENT
WM-9	SANITARY/SEPTIC WASTE MANAGEMENT
NS-9	VEHICLE AND EQUIPMENT FUELING
NS-10	VEHICLE AND EQUIPMENT MAINTENANCE

MATCHLINE D - SEE SHEET 6

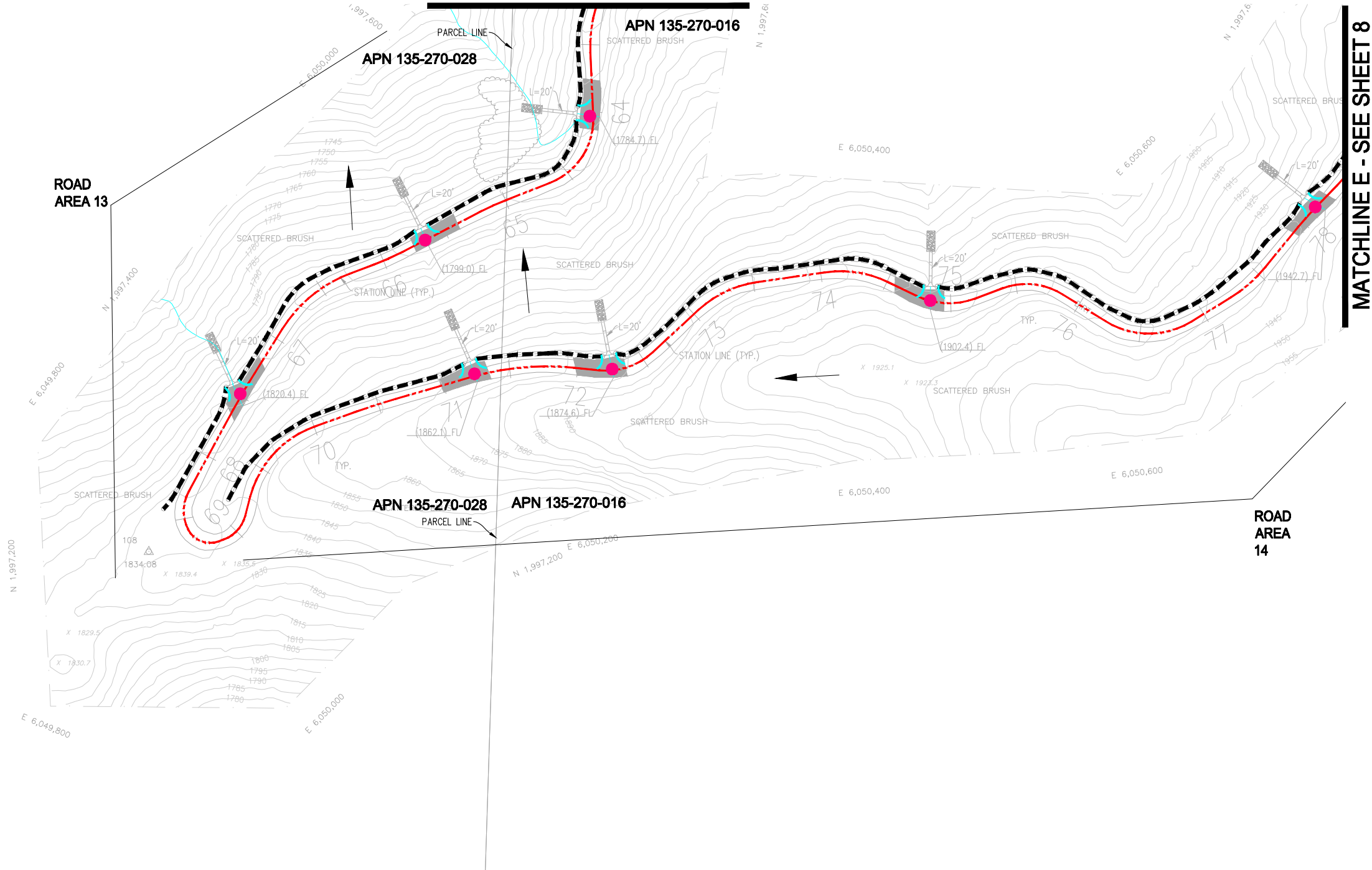

MATCHLINE E - SEE SHEET 8

Mac Drains shown in drawing above are not proposed to be completed as part of emergency O&M activities.

Michael Baker INTERNATIONAL
 5 Hutton Centre Drive
 Suite 500
 Santa Ana, CA 92707
 Phone: (949) 472-3505
 M.BAKER@INTL.COM

Andrew Price
 PROJECT MANAGER

DATE: 03.01.2023

SOUTHERN CALIFORNIA EDISON
 An EDISON INTERNATIONAL Company

Tunnel Road Trail, Road Areas 1-16 and Spur Roads
 LOCATION SANTA BARBARA COUNTY, CA

Storm Maintenance and Clean-up Operations

FOR: SOUTHERN CALIFORNIA EDISON

SHEET
7
 OF 9 SHEETS
 FILE NO.:

MATCHLINE F - SEE RIGHT

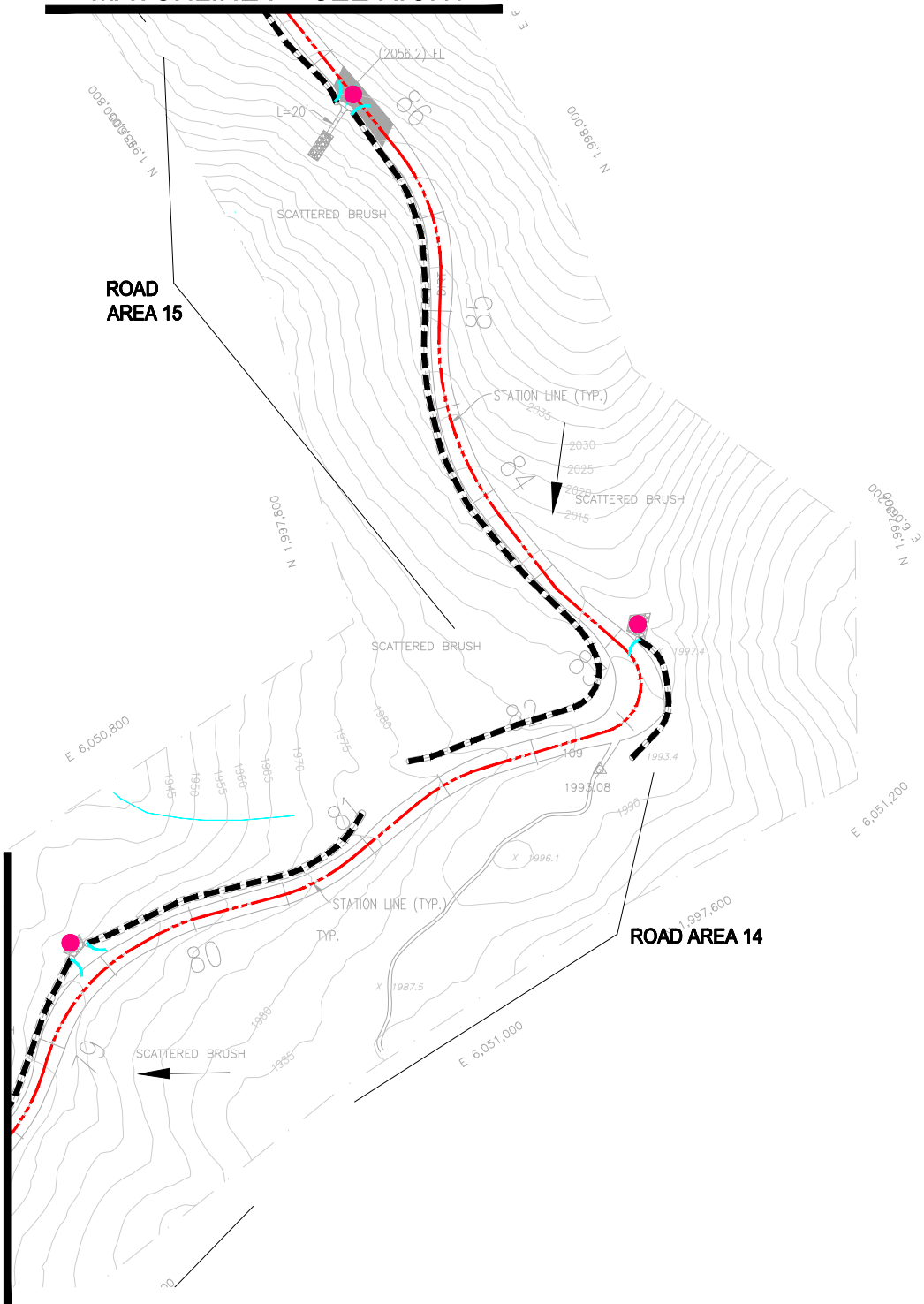

ROAD AREA 15

ROAD AREA 14

MATCHLINE E - SEE SHEET 7

EROSION CONTROL NOTES

1. PRESERVE EXISTING VEGETATION WHERE POSSIBLE (EC-2).
2. IMPLEMENT/INSTALL WIND EROSION CONTROLS AS NEEDED (WE-1).
3. INSTALL CHECK DAMS (SE-4) THROUGHOUT PROJECT AREA TO BREAK UP CONCENTRATED FLOW PATHS.
4. IMPLEMENT STREET SWEEPING (SE-7) AT GATE NEAR PROJECT ENTRANCE.
5. BMP LOCATIONS ARE APPROXIMATE.
6. CONSTRUCTION SHALL BE CONSIDERED COMPLETE ONCE ALL DISTURBED AREAS HAVE BEEN STABILIZED WITH NON-EROSIVE SURFACES AND ALL CONSTRUCTION-RELATED MATERIALS HAVE BEEN REMOVED FROM THE SITE.

LEGEND

- ← DIRECTION OF FLOWS
- WORK AREA - CENTER LINE
- CONCENTRATED FLOW PATH
- PROPOSED EARTHEN BERM
- PROPOSED DRAINAGE FEATURE
- *CHECK DAM (SE-4)
- *FIBER ROLL (SE-5)
- *GRAVEL BAG BERM (SE-6)
- *STORM DRAIN INLET PROTECTION (SE-10)
- ▨ *EROSION CONTROL BLANKET (EC-7)
- * [T] TRAILER
- * [CW] CONCRETE WASHOUT
- * [EM] VEHICLE & EQUIPMENT MAINTENANCE/ STAGING AREA
- * [M1] MATERIAL STORAGE
- * [ST] STOCKPILE AREA
- * [W] CONSTRUCTION WASTE STORAGE
- * [PT] PORTABLE TOILET
- * LOCATION TO BE UPDATED BY CONTRACTOR DURING CONSTRUCTION

MATCHLINE G - SEE SHEET 9

ROAD AREA 16

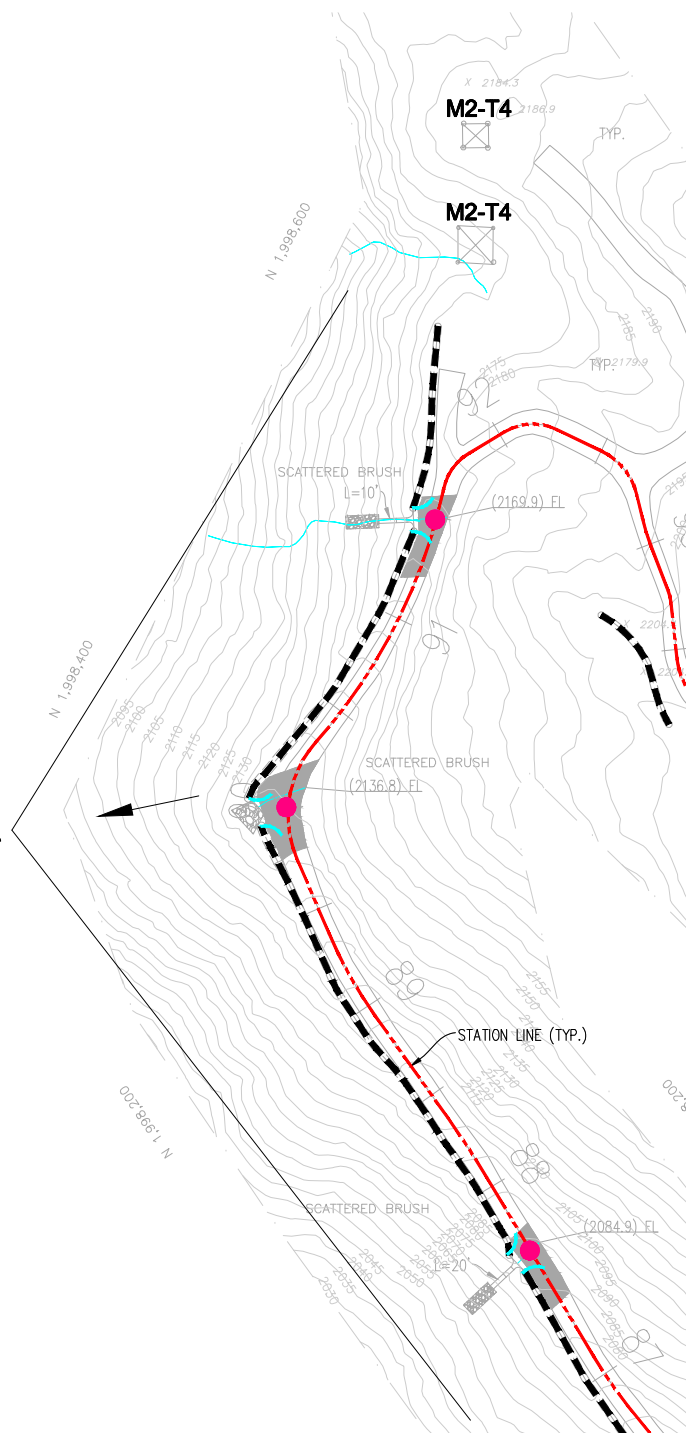

MATCHLINE F - SEE LEFT

BEST MANAGEMENT PRACTICES (BMPs)

EC-1 SCHEDULING	EC-10 VELOCITY DISSIPATION DEVICES	WM-1 MATERIAL DELIVERY AND STORAGE
EC-2 PRESERVATION OF EXISTING VEGETATION	EC-11 SLOPE DRAINS	WM-2 MATERIAL USE
EC-3 HYDRAULIC MULCH	SE-4 CHECK DAM	WM-3 STOCKPILE MANAGEMENT
EC-4 HYDROSEEDING	SE-5 FIBER ROLLS	WM-4 SPILL PREVENTION AND CONTROL
EC-7 GEOTEXTILES & MATS	SE-7 STREET SWEEPING AND VACUUMING	WM-5 SOLID WASTE MANAGEMENT
EC-9 EARTH DIKES AND DRAINAGE SWALES	WE-1 WIND EROSION CONTROL	WM-9 SANITARY/SEPTIC WASTE MANAGEMENT
		NS-9 VEHICLE AND EQUIPMENT FUELING
		NS-10 VEHICLE AND EQUIPMENT MAINTENANCE

Mac Drains shown in drawing above are not proposed to be completed as part of emergency O&M activities.

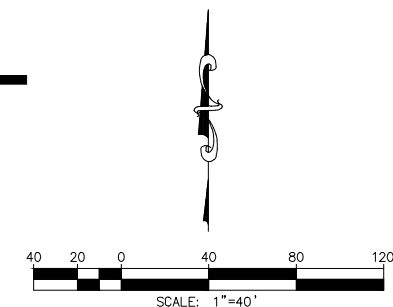

Michael Baker INTERNATIONAL
 5 Hutton Centre Drive Suite 500 Santa Ana, CA 92707
 Phone: (949) 472-3505 MBAKERINTL.COM

Andrew Price PROJECT MANAGER DATE: 03.01.2023

SOUTHERN CALIFORNIA EDISON
 An EDISON INTERNATIONAL Company

Tunnel Road Trail, Road Areas 1-16 and Spur Roads
 LOCATION SANTA BARBARA COUNTY, CA

Storm Maintenance and Clean-up Operations

FOR: SOUTHERN CALIFORNIA EDISON

SHEET **8** OF 9 SHEETS
 FILE NO.:

EROSION CONTROL NOTES

1. PRESERVE EXISTING VEGETATION WHERE POSSIBLE (EC-2).
2. IMPLEMENT/INSTALL WIND EROSION CONTROLS AS NEEDED (WE-1).
3. INSTALL CHECK DAMS (SE-4) THROUGHOUT PROJECT AREA TO BREAK UP CONCENTRATED FLOW PATHS.
4. IMPLEMENT STREET SWEEPING (SE-7) AT GATE NEAR PROJECT ENTRANCE.
5. BMP LOCATIONS ARE APPROXIMATE.
6. CONSTRUCTION SHALL BE CONSIDERED COMPLETE ONCE ALL DISTURBED AREAS HAVE BEEN STABILIZED WITH NON-EROSIVE SURFACES AND ALL CONSTRUCTION-RELATED MATERIALS HAVE BEEN REMOVED FROM THE SITE.

LEGEND

- DIRECTION OF FLOWS
- WORK AREA - CENTER LINE
- CONCENTRATED FLOW PATH
- PROPOSED EARTHEN BERM
- PROPOSED DRAINAGE FEATURE
- *CHECK DAM (SE-4)
- *FIBER ROLL (SE-5)
- *GRAVEL BAG BERM (SE-6)
- *STORM DRAIN INLET PROTECTION (SE-10)
- *EROSION CONTROL BLANKET (EC-7)
- *T TRAILER
- *CW CONCRETE WASHOUT
- *EM VEHICLE & EQUIPMENT MAINTENANCE/ STAGING AREA
- *M1 MATERIAL STORAGE
- *ST STOCKPILE AREA
- *W CONSTRUCTION WASTE STORAGE
- *PT PORTABLE TOILET
- * LOCATION TO BE UPDATED BY CONTRACTOR DURING CONSTRUCTION

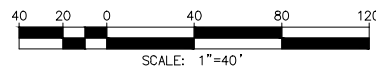

MATCHLINE G - SEE SHEET 8

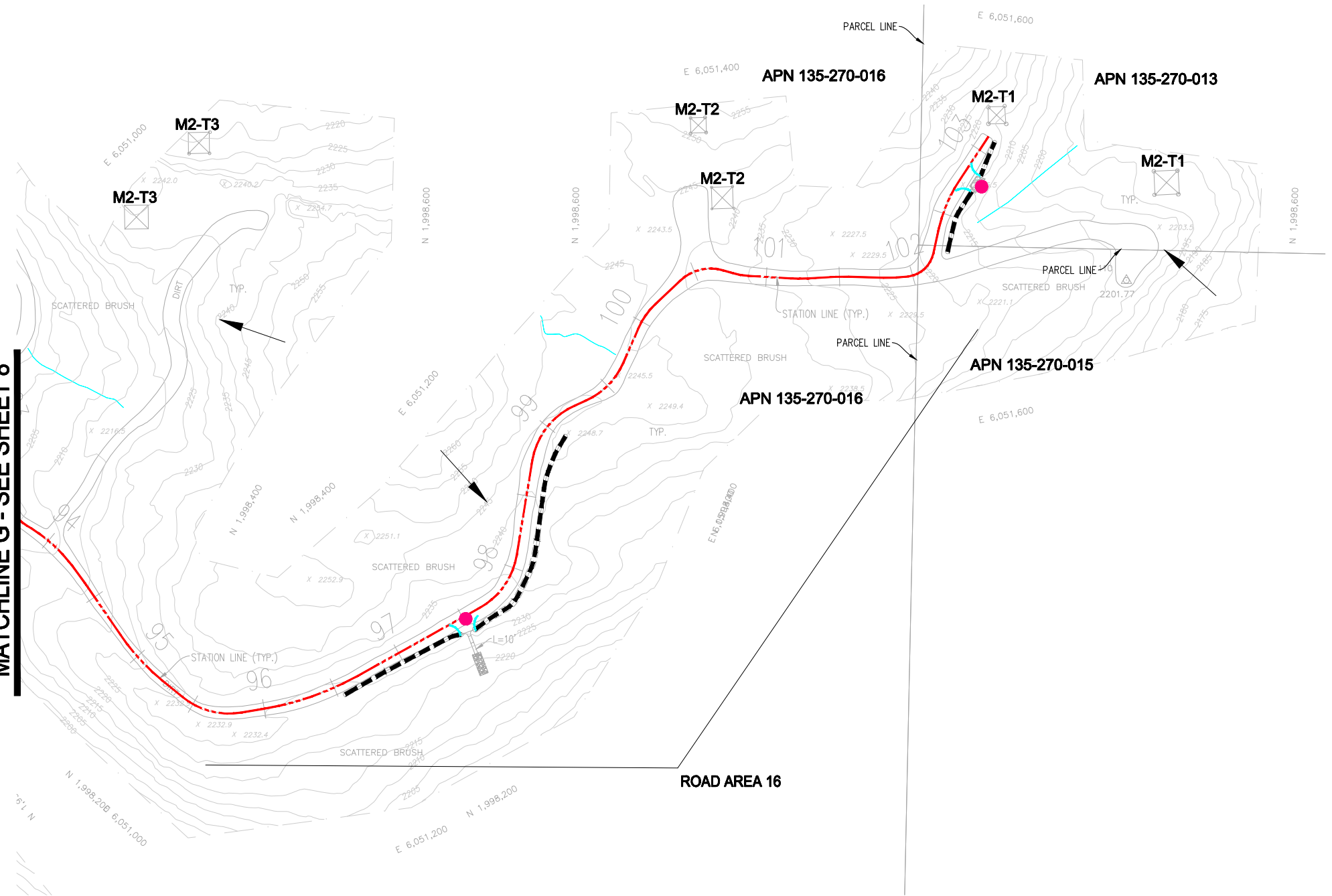

BEST MANAGEMENT PRACTICES (BMPs)

EC-1 SCHEDULING	EC-10 VELOCITY DISSIPATION DEVICES	WM-1 MATERIAL DELIVERY AND STORAGE
EC-2 PRESERVATION OF EXISTING VEGETATION	EC-11 SLOPE DRAINS	WM-2 MATERIAL USE
EC-3 HYDRAULIC MULCH	SE-4 CHECK DAM	WM-3 STOCKPILE MANAGEMENT
EC-4 HYDROSEEDING	SE-5 FIBER ROLLS	WM-4 SPILL PREVENTION AND CONTROL
EC-7 GEOTEXTILES & MATS	SE-7 STREET SWEEPING AND VACUUMING	WM-5 SOLID WASTE MANAGEMENT
EC-9 EARTH DIKES AND DRAINAGE SWALES	WE-1 WIND EROSION CONTROL	WM-9 SANITARY/SEPTIC WASTE MANAGEMENT
		NS-9 VEHICLE AND EQUIPMENT FUELING
		NS-10 VEHICLE AND EQUIPMENT MAINTENANCE

Mac Drains shown in drawing above are not proposed to be completed as part of emergency O&M activities.

Michael Baker INTERNATIONAL
 5 Hutton Centre Drive
 Suite 500
 Santa Ana, CA 92707
 Phone: (949) 472-3505
 MBAKERINTL.COM

Andrew Price
 PROJECT MANAGER

DATE: 03.01.2023

SOUTHERN CALIFORNIA EDISON
 An EDISON INTERNATIONAL Company

Tunnel Road Trail, Road Areas 1-16 and Spur Roads
 LOCATION SANTA BARBARA COUNTY, CA

Storm Maintenance and Clean-up Operations

FOR: SOUTHERN CALIFORNIA EDISON

SHEET
9
 OF 9 SHEETS
 FILE NO.: